



Catalog Number: 18184-SC1-NK
Item Description: N1 SCREW COVER ENCL NK
UPC Code: 784572103016

Brand Name: Milbank
Type: Screw Cover
Special Features: Cover Secured with Plated Screws
Application: Enclosure for Mounting Electrical Equipment
Standard: UL Listed
Number Of Outlet: 0
Material: Steel with Powder Coat Finish
Color: ANSI 61 Gray
Mounting: Wall Mount
NEMA Rating: Type 1



Utility requirements may vary. Always consult the serving utility for their requirements prior to ordering or installing this equipment. This product must always be installed by a licensed electrician. Installation of this equipment may require local electrical inspector approval.

CATALOG#	LABEL#
18184-SC1-()	1002135
RC-18184-SC1-()	1125021
SPSC-18184	1132714

ITEM	QTY.	PART NUMBER	DESCRIPTION
1	1	(SEE CHART)	BACK WELDMENT
2	1	(SEE CHART)	COVER PLATE
3	1	(SEE CHART)	U/L LISTING LABEL
4	1	1002475	BAG ASSY (GROUND SCREW)
5	4	1001290	SCREW, 10-32 X 5/16
6	0.33	1002931	CARTON 3-PER (NOT SHOWN)

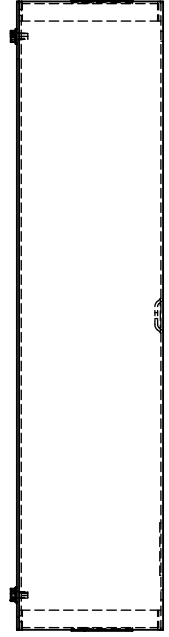
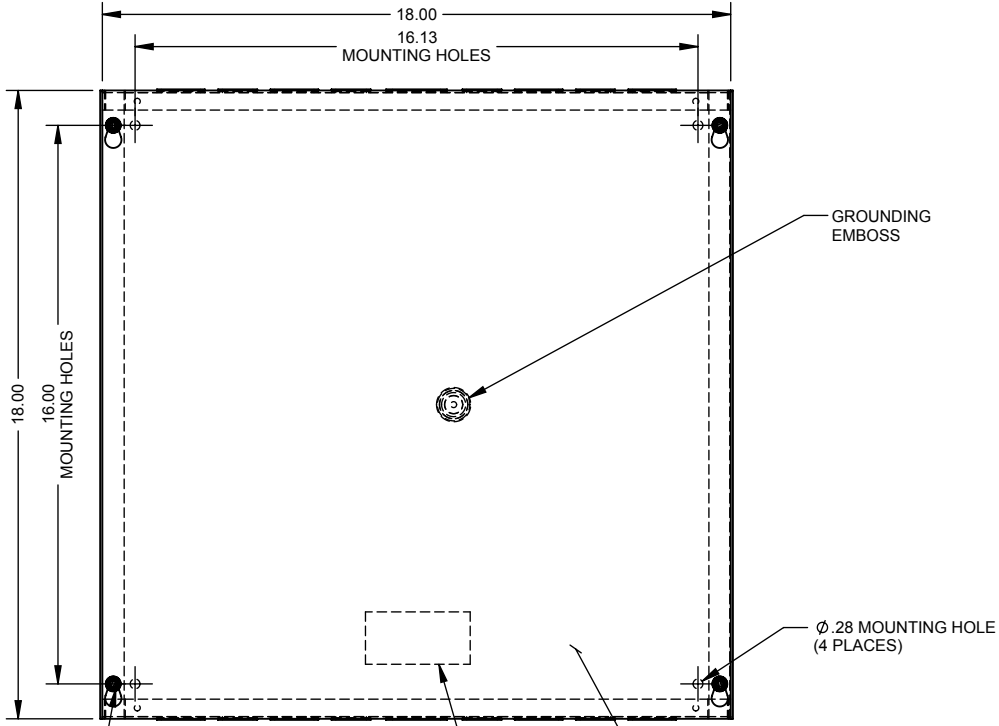

NOTES:
 1. PLACE BAG ASSY INSIDE ENCLOSURE (NOT SHOWN).

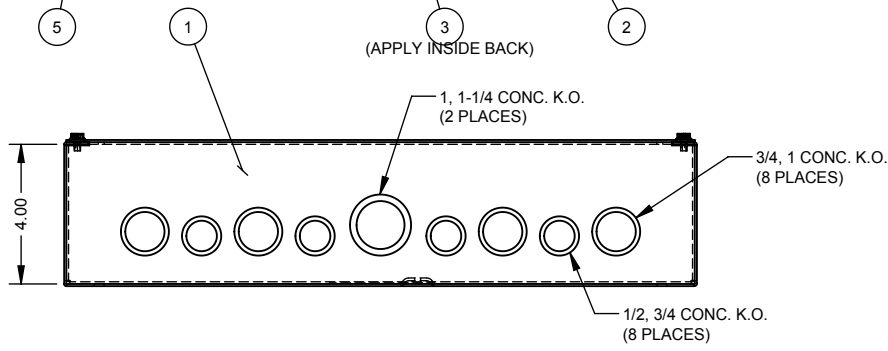

SUFFIX	FINISH	WELDMENT NO.	COVER NO.	INSTALL KOs
NONE	MILBANK LIGHT GRAY	1160238	1154419	YES
-NP	NONE	1160239	1003271	
-NK	MILBANK LIGHT GRAY	1011175	1154419	NO
-NK-NP	NONE	1160240	1003271	

NEMA DWG.: #117

Material:	16 GA. STEEL	 General Offices: Kansas City, MO
Finish:	(SEE CHART)	
Tolerances: Unless Specified Otherwise X.X ±.1 X.XX ±.03 X.XXX ±.015 X* ±2°		Title: 18184 SCREW COVER TYPE 1 ENCLOSURE Catalog No.: (SEE CHART) Customer: MILBANK STANDARD Drawing No.: 1001553
Scale:	NTS	Checked By:
Drawn By:	DY	Approved By:
Date:	04/26/01	Sheet 1 of 1

D	8/1/12	DELETE 1002646; ADD 1001290 (ECO #22728)	DF			
---	--------	--	----	--	--	--



Catalog Number: 18184-SC1-NK
Item Description: N1 SCREW COVER ENCL NK
UPC Code: 784572103016

Brand Name: Milbank
Type: Screw Cover
Special Features: Cover Secured with Plated Screws
Application: Enclosure for Mounting Electrical Equipment
Standard: UL Listed
Number Of Outlet: 0
Material: Steel with Powder Coat Finish
Color: ANSI 61 Gray
Mounting: Wall Mount
NEMA Rating: Type 1



Utility requirements may vary. Always consult the serving utility for their requirements prior to ordering or installing this equipment. This product must always be installed by a licensed electrician. Installation of this equipment may require local electrical inspector approval.

CATALOG#	LABEL#
18184-SC1-()	1002135
RC-18184-SC1-()	1125021
SPSC-18184	1132714

ITEM	QTY.	PART NUMBER	DESCRIPTION
1	1	(SEE CHART)	BACK WELDMENT
2	1	(SEE CHART)	COVER PLATE
3	1	(SEE CHART)	U/L LISTING LABEL
4	1	1002475	BAG ASSY (GROUND SCREW)
5	4	1001290	SCREW, 10-32 X 5/16
6	0.33	1002931	CARTON 3-PER (NOT SHOWN)

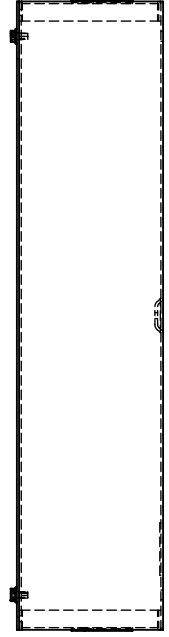
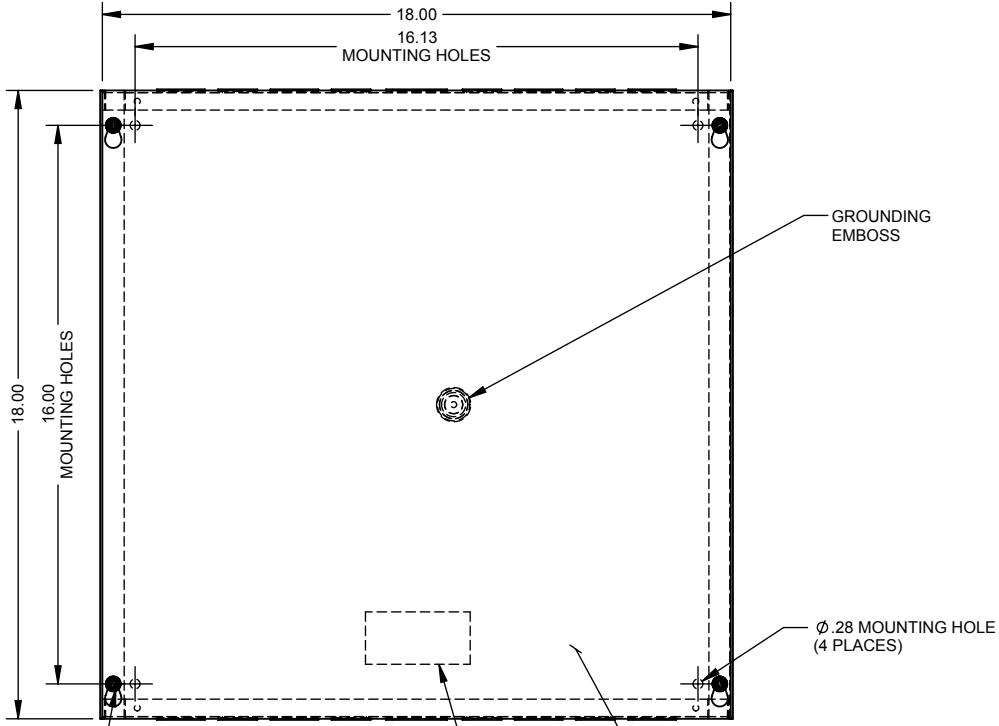

NOTES:
 1. PLACE BAG ASSY INSIDE ENCLOSURE (NOT SHOWN).

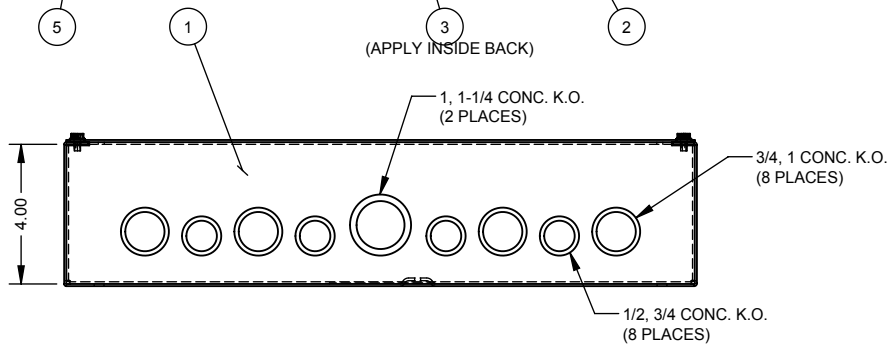

SUFFIX	FINISH	WELDMNT NO.	COVER NO.	INSTALL KOs
NONE	MILBANK LIGHT GRAY	1160238	1154419	YES
-NP	NONE	1160239	1003271	
-NK	MILBANK LIGHT GRAY	1011175	1154419	NO
-NK-NP	NONE	1160240	1003271	

NEMA DWG.: #117

Material:	16 GA. STEEL	 General Offices: Kansas City, MO
Finish:	(SEE CHART)	
Tolerances: Unless Specified Otherwise X.X ±.1 X.XX ±.03 X.XXX ±.015 X* ±2°		Title: 18184 SCREW COVER TYPE 1 ENCLOSURE Catalog No.: (SEE CHART) Customer: MILBANK STANDARD Drawing No.: 1001553
Scale:	NTS	Checked By: Date: 04/26/01
Drawn By:	DY	Approved By: Sheet 1 of 1

D	8/1/12	DELETE 1002646; ADD 1001290 (ECO #22728)	DF			
---	--------	--	----	--	--	--