

# Commercial grade straight blade duplex receptacles

Project Name:	Prepared By:
Project Number:	Date:
Catalog Number:	Type:

## Description

2-Pole, 3-Wire Grounding  
 15A 125V/AC; 15A 250V/AC  
 20A 125V/AC; 20A 250V/AC  
 NEMA 5-15, 5-20, 6-15, 6-20



5-15R



5-20R



6-15R



6-20R



BR15



CR20



1877

## Design features

- Galvanized steel, wrap-around yoke mounting strap for superior assembly security; extra length/width helps reach large panel cutouts for Code Compliance
- Automatic grounding system eliminates need for bonding jumper in grounded metal enclosure, provides redundant measure of ground continuity where jumper used
- Screw-Catch feature on duplex devices speeds mounting of wallplates
- Tamper Resistant receptacles provide compliance with 2014 NEC® Article 406.12 that states that all 15A & 20A, 125V receptacles installed in dwelling units must be tamper resistant

**Table 1. Commercial Grade Receptacles**

Catalog No.	Description	Amps	Volts	Color Suffix
<input type="checkbox"/> BR15__	NEMA 5-15R Duplex Receptacle, Back & Side Wire	15	125	A, B, BK, GY, LA, V, W
<input type="checkbox"/> CR15__	NEMA 5-15R Duplex Receptacle, Side Wire	15	125	A, B, BK, GY, LA, V, W
<input type="checkbox"/> 817__	NEMA 5-15R Single Receptacle, Side Wire	15	125	B, BK, LA, V, W
<input type="checkbox"/> BR20__	NEMA 5-20R Duplex Receptacle, Back & Side Wire	20	125	A, B, BK, GY, LA, RD, V, W
<input type="checkbox"/> CR20__	NEMA 5-20R Duplex Receptacle, Side Wire	20	125	A, B, BK, GY, LA, V, W
<input type="checkbox"/> 1877__	NEMA 5-20R Single Receptacle, Side Wire	20	125	A, B, BK, LA, V, W
<input type="checkbox"/> 826__	NEMA 6-15R Duplex Receptacle, Side Wire	15	250	B, V, W
<input type="checkbox"/> 816__	NEMA 6-15R Single Receptacle, Side Wire	15	250	B, V, W
<input type="checkbox"/> 815__	NEMA 6-20R Duplex Receptacle, Side Wire	20	250	B, V, W
<input type="checkbox"/> 1876__	NEMA 6-20R Single Receptacle, Side Wire	20	250	A, B, BK, LA, V, W

Compliances, specifications and availability are subject to change without notice.



Powering Business Worldwide

Project Name:	Prepared By:
Project Number:	Date:
Catalog Number:	Type:



TR817

**Table 2. Dual Voltage Commercial Grade Receptacles, Side Wire**

Catalog No.	Description	Amps	Volts	Color
□ 829V	NEMA 5-15R/6-15R Dual Voltage Duplex Receptacle, Side Wire	15	125/ 250	V

**Table 3. Commercial Grade Tamper Resistant Receptacles**

Catalog No.	Description	Amps	Volts	Color Suffix
□ TRBR15__	NEMA 5-15R Tamper Resistant Duplex Receptacle, Back & Side Wire	15	125	A, B, BK, GY, LA, V, W
□ TRCR15__	NEMA 5-15R Tamper Resistant Duplex Receptacle, Side Wire	15	125	A, B, BK, GY, LA, V, W
□ TR817__	NEMA 5-15R Single Receptacle, Side Wire	15	125	A, B, BK, LA, V, W
□ TRBR20__	NEMA 5-20R Tamper Resistant Duplex Receptacle, Back & Side Wire	20	125	A, B, BK, GY, LA, RD, V, W
□ TRCR20__	NEMA 5-20R Tamper Resistant Duplex Receptacle, Side Wire	20	125	A, B, BK, GY, LA, V, W
□ TR1877__	NEMA 5-20 Single Receptacle, Side Wire	20	125	A, B, BK, LA, V, W

Project Name:	Prepared By:
Project Number:	Date:
Catalog Number:	Type:

## Applications

Commercial grade duplex receptacles are challenged on a daily basis to provide a consistent, reliable means of connectivity in a wide variety of environments. The applications vary greatly by environment, and provide challenges from impact and chemical resistance to environmental extremes such as heat and moisture. The breadth of the Arrow Hart Straight Blade Receptacle line provides solutions for all environments and applications.

**Table 4. Specifications**

Catalog No.	BR15, BR20, Series	CR15, CR20 Series	815, 826 Series
<b>Device Type</b>	<b>Straight Blade Duplex Receptacles, BR Series</b>	<b>Straight Blade Duplex Receptacles, CR Series</b>	<b>Straight Blade Duplex Receptacles</b>
<b>Wiring Type</b>	Back & side wire	Side wire	Side wire
<b>Testing &amp; Code Compliance</b>	<ul style="list-style-type: none"> <li>cULus Listed to UL 498, file no. E15058</li> <li>CSA Certified to C22.2, no. 42, file no. 6914, class 6233-01</li> <li>UL verified to Federal Spec. WC-596G</li> <li>NOM certified</li> </ul>	<ul style="list-style-type: none"> <li>cULus Listed to UL 498, file no. E15058</li> <li>UL verified to Federal Spec. WC-596G</li> <li>NOM certified</li> </ul>	<ul style="list-style-type: none"> <li>cULus Listed to UL 498, file no. E15058</li> <li>UL verified to Federal Spec. WC-596G</li> <li>NOM certified</li> </ul>
<b>Environmental Specifications</b>	<b>Flammability:</b> Meets UL 94 requirements; V2 rated <b>Temperature Rating:</b> -20°C to 60°C (-4°F to 140°F)	<b>Flammability:</b> Meets UL 94 requirements; V2 rated <b>Temperature Rating:</b> -20°C to 60°C (-4°F to 140°F)	<b>Flammability:</b> Meets UL 94 requirements; V2 rated <b>Temperature Rating:</b> -20°C to 60°C (-4°F to 140°F)
<b>Electrical Specifications</b>	<b>Dielectric Voltage:</b> Withstands 2000V per UL 498 <b>Current Interrupting:</b> Yes, at full-rated current <b>Temperature Rise:</b> Max. 30°C (86°F) after 100 cycles of overload @ 150% of rated current (DC)	<b>Dielectric Voltage:</b> Withstands 2000V per UL 498 <b>Current Interrupting:</b> Yes, at full-rated current <b>Temperature Rise:</b> Max. 30°C (86°F) after 100 cycles of overload @ 150% of rated current (DC)	<b>Dielectric Voltage:</b> Withstands 2000V per UL 498 <b>Current Interrupting:</b> Yes, at full-rated current <b>Temperature Rise:</b> Max. 30°C (86°F) after 100 cycles of overload VVV@ 150% of rated current (DC)
<b>Mechanical Specifications</b>	<b>Terminal Accommodation:</b> #14 - 10 AWG <b>Voltage Ratings:</b> Permanently marked on device	<b>Terminal Accommodation:</b> #14 - 10 AWG <b>Voltage Ratings:</b> Permanently marked on device	<b>Terminal Accommodation:</b> #14 - 10 AWG <b>Voltage Ratings:</b> Permanently marked on device

**Table 5. Materials**

Catalog No.	BR15, BR20, Series	CR15, CR20 Series	815, 826 Series
<b>Top Housing</b>	Nylon	PVC	PC
<b>Bottom Housing</b>	PVC	PVC	PC
<b>Strap</b>	0.046" thick galvanized steel	0.040" thick galvanized steel	0.040" thick galvanized steel
<b>Ground Contact</b>	0.030" thick brass	0.030" thick brass	0.030" thick brass
<b>Auto Ground</b>	Phosphor bronze staple	Phosphor bronze staple	Phosphor bronze staple
<b>Line Contacts</b>	.030" thick 3-leaf brass	.030" thick 3-leaf neutral/2-leaf hot brass	.030" thick 3-leaf brass
<b>Terminal Screws</b>	#8-32 Steel brass plated hot	#8-32 Steel brass plated hot	#8-32 Steel brass plated hot
<b>Ground Screw</b>	#8-32 Steel (Green)	#8-32 Steel (Green)	#8-32 Steel (Green)
<b>Tamper Resistant Shutters</b>	N/A	N/A	N/A

Project Name:	Prepared By:
Project Number:	Date:
Catalog Number:	Type:

**Table 6. Specifications**

Catalog No.	829 Series	817, 1877 Series	816, 1876 Series
<b>Device Type</b>	<b>Straight Blade Dual Voltage Duplex Receptacles</b>	<b>Straight Blade Single Receptacles</b>	<b>Straight Blade Single Receptacles</b>
<b>Wiring Type</b>	Side wire	Side wire	Side wire
<b>Testing &amp; Code Compliance</b>	<ul style="list-style-type: none"> <li>UL Listed to UL 498, file no. E15058</li> <li>CSA Certified to C22.2, no. 42, file no. 6914, class 6233-01</li> <li>NOM certified</li> </ul>	<ul style="list-style-type: none"> <li>UL Listed to UL 498, file no. E15058</li> <li>CSA Certified to C22.2, no. 42, file no. 6914, class 6233-01</li> <li>NOM certified</li> </ul>	<ul style="list-style-type: none"> <li>cULus Listed to UL 498, file no. E15058</li> <li>NOM certified</li> </ul>
<b>Environmental Specifications</b>	<b>Flammability:</b> Meets UL 94 requirements; V2 rated <b>Temperature Rating:</b> -20°C to 60°C (-4°F to 140°F)	<b>Flammability:</b> Meets UL 94 requirements; V2 rated <b>Temperature Rating:</b> -20°C to 60°C (-4°F to 140°F)	<b>Flammability:</b> Meets UL 94 requirements; V2 rated <b>Temperature Rating:</b> -20°C to 60°C (-4°F to 140°F)
<b>Electrical Specifications</b>	<b>Dielectric Voltage:</b> Withstands 2000V per UL 498 <b>Current Interrupting:</b> Yes, at full-rated current <b>Temperature Rise:</b> Max. 30°C (86°F) after 100 cycles of overload @ 150% of rated current (DC)	<b>Dielectric Voltage:</b> Withstands 2000V per UL 498 <b>Current Interrupting:</b> Yes, at full-rated current <b>Temperature Rise:</b> Max. 30°C (86°F) after 100 cycles of overload @ 150% of rated current (DC)	<b>Dielectric Voltage:</b> Withstands 2000V per UL 498 <b>Current Interrupting:</b> Yes, at full-rated current <b>Temperature Rise:</b> Max. 30°C (86°F) after 100 cycles of overload WW@ 150% of rated current (DC)
<b>Mechanical Specifications</b>	<b>Terminal Accommodation:</b> #14 - 10 AWG <b>Voltage Ratings:</b> Permanently marked on device	<b>Terminal Accommodation:</b> #14 - 10 AWG <b>Voltage Ratings:</b> Permanently marked on device	<b>Terminal Accommodation:</b> #14 - 10 AWG <b>Voltage Ratings:</b> Permanently marked on device

**Table 7. Materials**

Catalog No.	829 Series	817, 1877 Series	816, 1876 Series
<b>Top Housing</b>	PC	PVC	Nylon
<b>Bottom Housing</b>	PC	PVC	PVC
<b>Strap</b>	0.040" thick galvanized steel	0.040" thick galvanized steel	0.040" thick galvanized steel
<b>Ground Contact</b>	0.030" thick brass	0.030" thick brass	0.030" thick brass
<b>Auto Ground</b>	Phosphor bronze staple	N/A	N/A
<b>Line Contacts</b>	.030" thick 3-leaf neutral/2-leaf hot brass	.030" thick 3-leaf brass	.030" thick 3-leaf brass
<b>Terminal Screws</b>	#8-32 Steel brass plated hot	#8-32 Steel brass plated hot	#8-32 Steel brass plated hot
<b>Ground Screw</b>	#8-32 Steel (Green)	#8-32 Steel (Green)	#8-32 Steel (Green)
<b>Tamper Resistant Shutters</b>	N/A	N/A	N/A

# Commercial grade straight blade duplex receptacles

Project Name:	Prepared By:
Project Number:	Date:
Catalog Number:	Type:

**Table 8. Specifications**

Catalog No.	TRBR15, TRCR15, TRBR20, TRCR20 Series	TR817, TR1877 Series
<b>Device Type</b>	<b>Tamper Resistant Straight Blade Duplex Receptacles</b>	<b>Tamper Resistant Straight Blade Single Receptacles</b>
<b>Wiring Type</b>	Back & side wire (TRCR side wire only)	Side wire
<b>Testing &amp; Code Compliance</b>	<ul style="list-style-type: none"> <li>• cULus Listed to UL 498, file no. E15058</li> <li>• UL verified to Federal Spec. WVC-596G (TRBR only)</li> <li>• NOM certified</li> </ul>	<ul style="list-style-type: none"> <li>• cULus Listed to UL 498, file no. E15058</li> <li>• NOM certified</li> </ul>
<b>Environmental Specifications</b>	<b>Flammability:</b> Meets UL 94 requirements; V2 rated <b>Temperature Rating:</b> -20°C to 60°C (-4°F to 140°F)	<b>Flammability:</b> Meets UL 94 requirements; V2 rated <b>Temperature Rating:</b> -20°C to 60°C (-4°F to 140°F)
<b>Electrical Specifications</b>	<b>Dielectric Voltage:</b> Withstands 2000V per UL 498 <b>Current Interrupting:</b> Yes, at full-rated current <b>Temperature Rise:</b> Max. 30°C (86°F) after 100 cycles of overload @ 150% of rated current (DC)	<b>Dielectric Voltage:</b> Withstands 2000V per UL 498 <b>Current Interrupting:</b> Yes, at full-rated current <b>Temperature Rise:</b> Max. 30°C (86°F) after 100 cycles of overload @ 150% of rated current (DC)
<b>Mechanical Specifications</b>	<b>Terminal Accommodation:</b> #14 - 10 AWG <b>Voltage Ratings:</b> Permanently marked on device	<b>Terminal Accommodation:</b> #14 - 10 AWG <b>Voltage Ratings:</b> Permanently marked on device

**Table 9. Materials**

Catalog No.	TRBR15, TRCR15, TRBR20, TRCR20 Series	TR817, TR1877 Series
<b>Top Housing</b>	PVC	PVC
<b>Bottom Housing</b>	PVC	PVC
<b>Strap</b>	0.040" thick galvanized steel	0.040" thick galvanized steel
<b>Ground Contact</b>	0.030" thick brass	0.030" thick brass
<b>Auto Ground</b>	Phosphor bronze staple	Phosphor bronze staple
<b>Line Contacts</b>	.030" thick 3-leaf neutral/2-leaf hot brass	.030" thick 3-leaf brass
<b>Terminal Screws</b>	#8-32 Steel brass plated hot	#8-32 Steel brass plated hot
<b>Ground Screw</b>	#8-32 Steel (Green)	#8-32 Steel (Green)
<b>Tamper Resistant Shutters</b>	Reliable Delrin® shutter assembly	Reliable Delrin® shutter assembly

**Table 10. Color Ordering Information**

For ordering devices, include Cat. No. followed by the color code: A (Almond), B (Brown), BK (Black), GY (Gray) LA (Light Almond), RD (Red), V (Ivory), W (White)

A	B	BK	GY	LA	RD	V	W
Almond	Brown	Black	Gray	Lt. Almond	Red	Ivory	White

Project Name:	Prepared By:
Project Number:	Date:
Catalog Number:	Type:

**Product Dimensions**

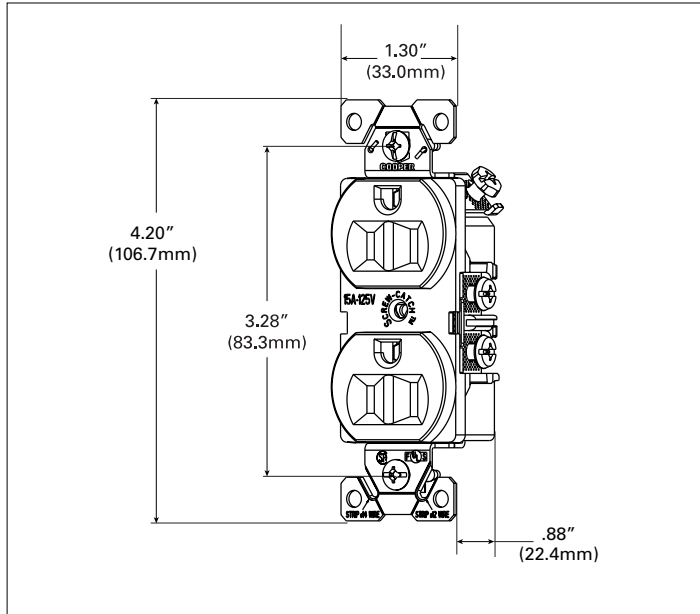

**Figure 1. BR15 Line Art with Dimensions**

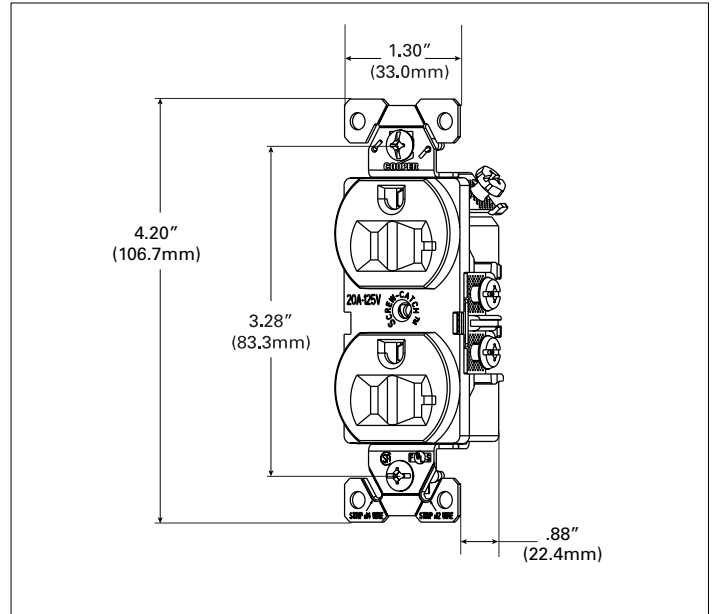

**Figure 2. BR20 Line Art with Dimensions**

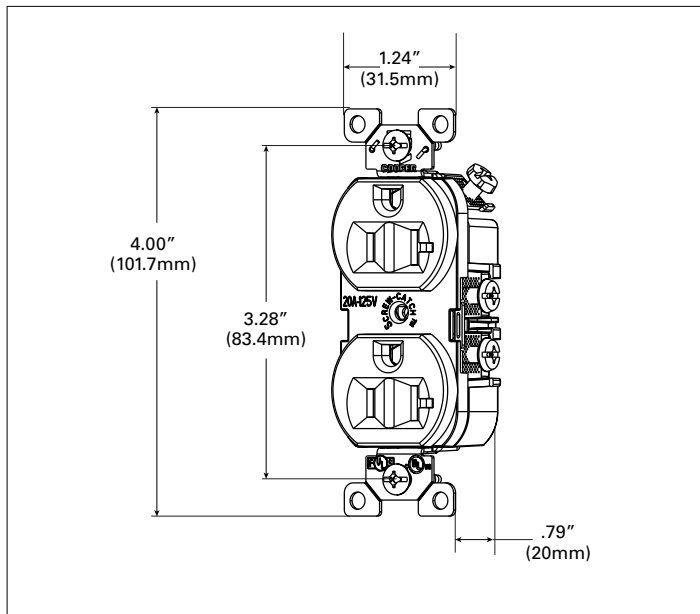

**Figure 3. CR20 Line Art with Dimensions**

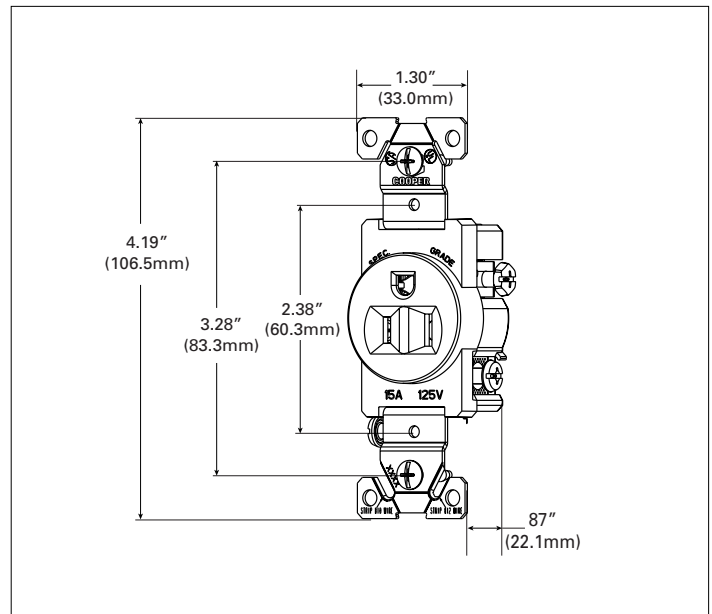

**Figure 4. 817 Line Art with Dimensions**

Project Name:	Prepared By:
Project Number:	Date:
Catalog Number:	Type:

**Product Dimensions**



Figure 5. 1877 Line Art with Dimensions



Figure 6. TRBR15 Line Art with Dimensions



Figure 7. TRBR20 Line Art with Dimensions



Figure 8. TRCR15 Line Art with Dimensions

Project Name:	Prepared By:
Project Number:	Date:
Catalog Number:	Type:

**Product Dimensions**

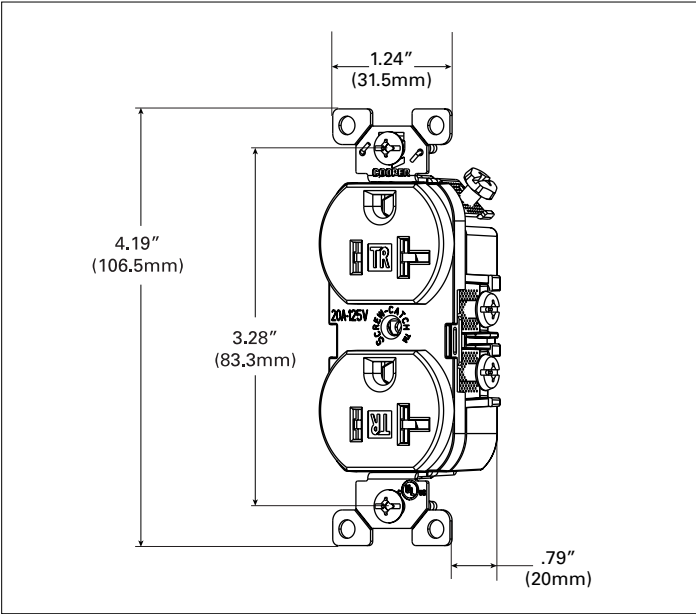

**Figure 9. TRCR20 Line Art with Dimensions**

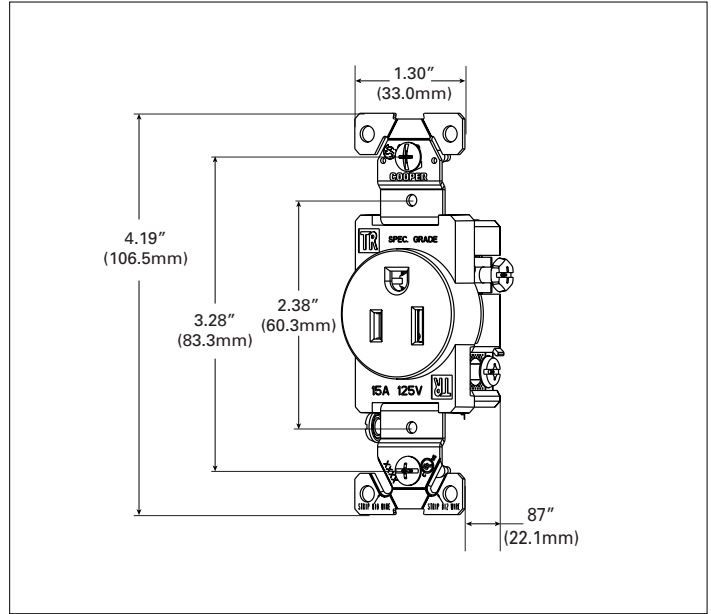

**Figure 10. TR817 Line Art with Dimensions**

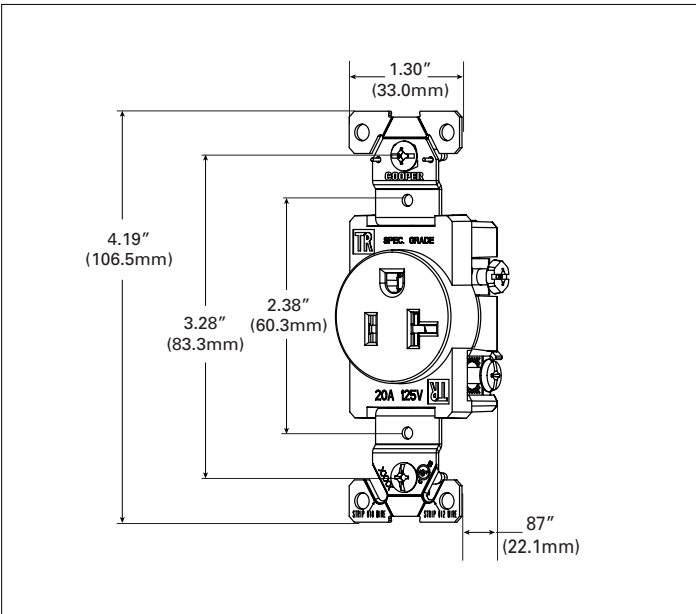









**Figure 11. TR1877 Line Art with Dimensions**



Project Name:	Prepared By:
Project Number:	Date:
Catalog Number:	Type:

### Certifications & compliances

Catalog No.									
BR15	•	•	•	•	•	•	•	•	•
CR15	•		•			•		•	•
817		•		•	•	•		•	•
BR20	•	•	•	•	•	•	•	•	•
CR20	•		•			•		•	•
1877		•		•	•	•		•	•
826	•		•			•		•	•
816	•		•			•		•	•
815	•	•	•		•	•		•	•
1876	•		•			•		•	•
829		•	•		•	•		•	•
TRBR15	•		•			•	•	•	•
TRCR15	•					•		•	•
TR817	•		•			•		•	•
TRBR20	•		•			•	•	•	•
TRCR20	•					•		•	•
TR1877	•					•		•	•

**KEY:**  cULus  UL  Fed Spec  NAFTA  CSA  
 NOM  Arrowlink  Build-To-Spec  ROHS

 Parts are manufactured and designed in accordance with article 4 of the European Union's RoHS2 directive 2011/65/EU

 Build-To-Spec Customizable Devices

**Compliances, specifications and availability are subject to change without notice.**

Electrical Sector  
203 Cooper Circle  
Peachtree City, GA 30269  
United States  
Eaton.com  
Eaton.com/arrowhart

Electrical Sector  
Canada Operations  
5925 McLaughlin Road  
Mississauga, Ontario, L5R 1B8  
Canada  
EatonCanada.ca  
Eaton.com/arrowhart

Electrical Sector  
Mexico Operations  
Carr. Tlalnepantla -  
Cuautitlan Km 17.8 s/n  
Col. Villa Jardin esq.  
Cerrada 8 de Mayo  
Cuautitlan, Mexico CP 54800  
Mexico  
Eaton.mx  
Eaton.com/arrowhart

# Commercial grade straight blade duplex receptacles

Project Name:	Prepared By:
Project Number:	Date:
Catalog Number:	Type:

## Description

2-Pole, 3-Wire Grounding  
 15A 125V/AC; 15A 250V/AC  
 20A 125V/AC; 20A 250V/AC  
 NEMA 5-15, 5-20, 6-15, 6-20



5-15R



5-20R



6-15R



6-20R



BR15



CR20



1877

## Design features

- Galvanized steel, wrap-around yoke mounting strap for superior assembly security; extra length/width helps reach large panel cutouts for Code Compliance
- Automatic grounding system eliminates need for bonding jumper in grounded metal enclosure, provides redundant measure of ground continuity where jumper used
- Screw-Catch feature on duplex devices speeds mounting of wallplates
- Tamper Resistant receptacles provide compliance with 2014 NEC® Article 406.12 that states that all 15A & 20A, 125V receptacles installed in dwelling units must be tamper resistant

**Table 1. Commercial Grade Receptacles**

Catalog No.	Description	Amps	Volts	Color Suffix
<input type="checkbox"/> BR15__	NEMA 5-15R Duplex Receptacle, Back & Side Wire	15	125	A, B, BK, GY, LA, V, W
<input type="checkbox"/> CR15__	NEMA 5-15R Duplex Receptacle, Side Wire	15	125	A, B, BK, GY, LA, V, W
<input type="checkbox"/> 817__	NEMA 5-15R Single Receptacle, Side Wire	15	125	B, BK, LA, V, W
<input type="checkbox"/> BR20__	NEMA 5-20R Duplex Receptacle, Back & Side Wire	20	125	A, B, BK, GY, LA, RD, V, W
<input type="checkbox"/> CR20__	NEMA 5-20R Duplex Receptacle, Side Wire	20	125	A, B, BK, GY, LA, V, W
<input type="checkbox"/> 1877__	NEMA 5-20R Single Receptacle, Side Wire	20	125	A, B, BK, LA, V, W
<input type="checkbox"/> 826__	NEMA 6-15R Duplex Receptacle, Side Wire	15	250	B, V, W
<input type="checkbox"/> 816__	NEMA 6-15R Single Receptacle, Side Wire	15	250	B, V, W
<input type="checkbox"/> 815__	NEMA 6-20R Duplex Receptacle, Side Wire	20	250	B, V, W
<input type="checkbox"/> 1876__	NEMA 6-20R Single Receptacle, Side Wire	20	250	A, B, BK, LA, V, W

Compliances, specifications and availability are subject to change without notice.



Powering Business Worldwide

Project Name:	Prepared By:
Project Number:	Date:
Catalog Number:	Type:



TR817

**Table 2. Dual Voltage Commercial Grade Receptacles, Side Wire**

Catalog No.	Description	Amps	Volts	Color
□ 829V	NEMA 5-15R/6-15R Dual Voltage Duplex Receptacle, Side Wire	15	125/ 250	V

**Table 3. Commercial Grade Tamper Resistant Receptacles**

Catalog No.	Description	Amps	Volts	Color Suffix
□ TRBR15__	NEMA 5-15R Tamper Resistant Duplex Receptacle, Back & Side Wire	15	125	A, B, BK, GY, LA, V, W
□ TRCR15__	NEMA 5-15R Tamper Resistant Duplex Receptacle, Side Wire	15	125	A, B, BK, GY, LA, V, W
□ TR817__	NEMA 5-15R Single Receptacle, Side Wire	15	125	A, B, BK, LA, V, W
□ TRBR20__	NEMA 5-20R Tamper Resistant Duplex Receptacle, Back & Side Wire	20	125	A, B, BK, GY, LA, RD, V, W
□ TRCR20__	NEMA 5-20R Tamper Resistant Duplex Receptacle, Side Wire	20	125	A, B, BK, GY, LA, V, W
□ TR1877__	NEMA 5-20 Single Receptacle, Side Wire	20	125	A, B, BK, LA, V, W

Project Name:	Prepared By:
Project Number:	Date:
Catalog Number:	Type:

## Applications

Commercial grade duplex receptacles are challenged on a daily basis to provide a consistent, reliable means of connectivity in a wide variety of environments. The applications vary greatly by environment, and provide challenges from impact and chemical resistance to environmental extremes such as heat and moisture. The breadth of the Arrow Hart Straight Blade Receptacle line provides solutions for all environments and applications.

**Table 4. Specifications**

Catalog No.	BR15, BR20, Series	CR15, CR20 Series	815, 826 Series
<b>Device Type</b>	<b>Straight Blade Duplex Receptacles, BR Series</b>	<b>Straight Blade Duplex Receptacles, CR Series</b>	<b>Straight Blade Duplex Receptacles</b>
<b>Wiring Type</b>	Back & side wire	Side wire	Side wire
<b>Testing &amp; Code Compliance</b>	<ul style="list-style-type: none"> <li>cULus Listed to UL 498, file no. E15058</li> <li>CSA Certified to C22.2, no. 42, file no. 6914, class 6233-01</li> <li>UL verified to Federal Spec. WC-596G</li> <li>NOM certified</li> </ul>	<ul style="list-style-type: none"> <li>cULus Listed to UL 498, file no. E15058</li> <li>UL verified to Federal Spec. WC-596G</li> <li>NOM certified</li> </ul>	<ul style="list-style-type: none"> <li>cULus Listed to UL 498, file no. E15058</li> <li>UL verified to Federal Spec. WC-596G</li> <li>NOM certified</li> </ul>
<b>Environmental Specifications</b>	<b>Flammability:</b> Meets UL 94 requirements; V2 rated <b>Temperature Rating:</b> -20°C to 60°C (-4°F to 140°F)	<b>Flammability:</b> Meets UL 94 requirements; V2 rated <b>Temperature Rating:</b> -20°C to 60°C (-4°F to 140°F)	<b>Flammability:</b> Meets UL 94 requirements; V2 rated <b>Temperature Rating:</b> -20°C to 60°C (-4°F to 140°F)
<b>Electrical Specifications</b>	<b>Dielectric Voltage:</b> Withstands 2000V per UL 498 <b>Current Interrupting:</b> Yes, at full-rated current <b>Temperature Rise:</b> Max. 30°C (86°F) after 100 cycles of overload @ 150% of rated current (DC)	<b>Dielectric Voltage:</b> Withstands 2000V per UL 498 <b>Current Interrupting:</b> Yes, at full-rated current <b>Temperature Rise:</b> Max. 30°C (86°F) after 100 cycles of overload @ 150% of rated current (DC)	<b>Dielectric Voltage:</b> Withstands 2000V per UL 498 <b>Current Interrupting:</b> Yes, at full-rated current <b>Temperature Rise:</b> Max. 30°C (86°F) after 100 cycles of overload VVV@ 150% of rated current (DC)
<b>Mechanical Specifications</b>	<b>Terminal Accommodation:</b> #14 - 10 AWG <b>Voltage Ratings:</b> Permanently marked on device	<b>Terminal Accommodation:</b> #14 - 10 AWG <b>Voltage Ratings:</b> Permanently marked on device	<b>Terminal Accommodation:</b> #14 - 10 AWG <b>Voltage Ratings:</b> Permanently marked on device

**Table 5. Materials**

Catalog No.	BR15, BR20, Series	CR15, CR20 Series	815, 826 Series
<b>Top Housing</b>	Nylon	PVC	PC
<b>Bottom Housing</b>	PVC	PVC	PC
<b>Strap</b>	0.046" thick galvanized steel	0.040" thick galvanized steel	0.040" thick galvanized steel
<b>Ground Contact</b>	0.030" thick brass	0.030" thick brass	0.030" thick brass
<b>Auto Ground</b>	Phosphor bronze staple	Phosphor bronze staple	Phosphor bronze staple
<b>Line Contacts</b>	.030" thick 3-leaf brass	.030" thick 3-leaf neutral/2-leaf hot brass	.030" thick 3-leaf brass
<b>Terminal Screws</b>	#8-32 Steel brass plated hot	#8-32 Steel brass plated hot	#8-32 Steel brass plated hot
<b>Ground Screw</b>	#8-32 Steel (Green)	#8-32 Steel (Green)	#8-32 Steel (Green)
<b>Tamper Resistant Shutters</b>	N/A	N/A	N/A

Project Name:	Prepared By:
Project Number:	Date:
Catalog Number:	Type:

**Table 6. Specifications**

Catalog No.	829 Series	817, 1877 Series	816, 1876 Series
<b>Device Type</b>	<b>Straight Blade Dual Voltage Duplex Receptacles</b>	<b>Straight Blade Single Receptacles</b>	<b>Straight Blade Single Receptacles</b>
<b>Wiring Type</b>	Side wire	Side wire	Side wire
<b>Testing &amp; Code Compliance</b>	<ul style="list-style-type: none"> <li>UL Listed to UL 498, file no. E15058</li> <li>CSA Certified to C22.2, no. 42, file no. 6914, class 6233-01</li> <li>NOM certified</li> </ul>	<ul style="list-style-type: none"> <li>UL Listed to UL 498, file no. E15058</li> <li>CSA Certified to C22.2, no. 42, file no. 6914, class 6233-01</li> <li>NOM certified</li> </ul>	<ul style="list-style-type: none"> <li>cULus Listed to UL 498, file no. E15058</li> <li>NOM certified</li> </ul>
<b>Environmental Specifications</b>	<b>Flammability:</b> Meets UL 94 requirements; V2 rated <b>Temperature Rating:</b> -20°C to 60°C (-4°F to 140°F)	<b>Flammability:</b> Meets UL 94 requirements; V2 rated <b>Temperature Rating:</b> -20°C to 60°C (-4°F to 140°F)	<b>Flammability:</b> Meets UL 94 requirements; V2 rated <b>Temperature Rating:</b> -20°C to 60°C (-4°F to 140°F)
<b>Electrical Specifications</b>	<b>Dielectric Voltage:</b> Withstands 2000V per UL 498 <b>Current Interrupting:</b> Yes, at full-rated current <b>Temperature Rise:</b> Max. 30°C (86°F) after 100 cycles of overload @ 150% of rated current (DC)	<b>Dielectric Voltage:</b> Withstands 2000V per UL 498 <b>Current Interrupting:</b> Yes, at full-rated current <b>Temperature Rise:</b> Max. 30°C (86°F) after 100 cycles of overload @ 150% of rated current (DC)	<b>Dielectric Voltage:</b> Withstands 2000V per UL 498 <b>Current Interrupting:</b> Yes, at full-rated current <b>Temperature Rise:</b> Max. 30°C (86°F) after 100 cycles of overload WW@ 150% of rated current (DC)
<b>Mechanical Specifications</b>	<b>Terminal Accommodation:</b> #14 - 10 AWG <b>Voltage Ratings:</b> Permanently marked on device	<b>Terminal Accommodation:</b> #14 - 10 AWG <b>Voltage Ratings:</b> Permanently marked on device	<b>Terminal Accommodation:</b> #14 - 10 AWG <b>Voltage Ratings:</b> Permanently marked on device

**Table 7. Materials**

Catalog No.	829 Series	817, 1877 Series	816, 1876 Series
<b>Top Housing</b>	PC	PVC	Nylon
<b>Bottom Housing</b>	PC	PVC	PVC
<b>Strap</b>	0.040" thick galvanized steel	0.040" thick galvanized steel	0.040" thick galvanized steel
<b>Ground Contact</b>	0.030" thick brass	0.030" thick brass	0.030" thick brass
<b>Auto Ground</b>	Phosphor bronze staple	N/A	N/A
<b>Line Contacts</b>	.030" thick 3-leaf neutral/2-leaf hot brass	.030" thick 3-leaf brass	.030" thick 3-leaf brass
<b>Terminal Screws</b>	#8-32 Steel brass plated hot	#8-32 Steel brass plated hot	#8-32 Steel brass plated hot
<b>Ground Screw</b>	#8-32 Steel (Green)	#8-32 Steel (Green)	#8-32 Steel (Green)
<b>Tamper Resistant Shutters</b>	N/A	N/A	N/A

# Commercial grade straight blade duplex receptacles

Project Name:	Prepared By:
Project Number:	Date:
Catalog Number:	Type:

**Table 8. Specifications**

Catalog No.	TRBR15, TRCR15, TRBR20, TRCR20 Series	TR817, TR1877 Series
<b>Device Type</b>	<b>Tamper Resistant Straight Blade Duplex Receptacles</b>	<b>Tamper Resistant Straight Blade Single Receptacles</b>
<b>Wiring Type</b>	Back & side wire (TRCR side wire only)	Side wire
<b>Testing &amp; Code Compliance</b>	<ul style="list-style-type: none"> <li>cULus Listed to UL 498, file no. E15058</li> <li>UL verified to Federal Spec. WVC-596G (TRBR only)</li> <li>NOM certified</li> </ul>	<ul style="list-style-type: none"> <li>cULus Listed to UL 498, file no. E15058</li> <li>NOM certified</li> </ul>
<b>Environmental Specifications</b>	<b>Flammability:</b> Meets UL 94 requirements; V2 rated <b>Temperature Rating:</b> -20°C to 60°C (-4°F to 140°F)	<b>Flammability:</b> Meets UL 94 requirements; V2 rated <b>Temperature Rating:</b> -20°C to 60°C (-4°F to 140°F)
<b>Electrical Specifications</b>	<b>Dielectric Voltage:</b> Withstands 2000V per UL 498 <b>Current Interrupting:</b> Yes, at full-rated current <b>Temperature Rise:</b> Max. 30°C (86°F) after 100 cycles of overload @ 150% of rated current (DC)	<b>Dielectric Voltage:</b> Withstands 2000V per UL 498 <b>Current Interrupting:</b> Yes, at full-rated current <b>Temperature Rise:</b> Max. 30°C (86°F) after 100 cycles of overload @ 150% of rated current (DC)
<b>Mechanical Specifications</b>	<b>Terminal Accommodation:</b> #14 - 10 AWG <b>Voltage Ratings:</b> Permanently marked on device	<b>Terminal Accommodation:</b> #14 - 10 AWG <b>Voltage Ratings:</b> Permanently marked on device

**Table 9. Materials**

Catalog No.	TRBR15, TRCR15, TRBR20, TRCR20 Series	TR817, TR1877 Series
<b>Top Housing</b>	PVC	PVC
<b>Bottom Housing</b>	PVC	PVC
<b>Strap</b>	0.040" thick galvanized steel	0.040" thick galvanized steel
<b>Ground Contact</b>	0.030" thick brass	0.030" thick brass
<b>Auto Ground</b>	Phosphor bronze staple	Phosphor bronze staple
<b>Line Contacts</b>	.030" thick 3-leaf neutral/2-leaf hot brass	.030" thick 3-leaf brass
<b>Terminal Screws</b>	#8-32 Steel brass plated hot	#8-32 Steel brass plated hot
<b>Ground Screw</b>	#8-32 Steel (Green)	#8-32 Steel (Green)
<b>Tamper Resistant Shutters</b>	Reliable Delrin® shutter assembly	Reliable Delrin® shutter assembly

**Table 10. Color Ordering Information**

For ordering devices, include Cat. No. followed by the color code: A (Almond), B (Brown), BK (Black), GY (Gray) LA (Light Almond), RD (Red), V (Ivory), W (White)

<b>A</b>	<b>B</b>	<b>BK</b>	<b>GY</b>	<b>LA</b>	<b>RD</b>	<b>V</b>	<b>W</b>
Almond	Brown	Black	Gray	Lt. Almond	Red	Ivory	White

Project Name:	Prepared By:
Project Number:	Date:
Catalog Number:	Type:

**Product Dimensions**

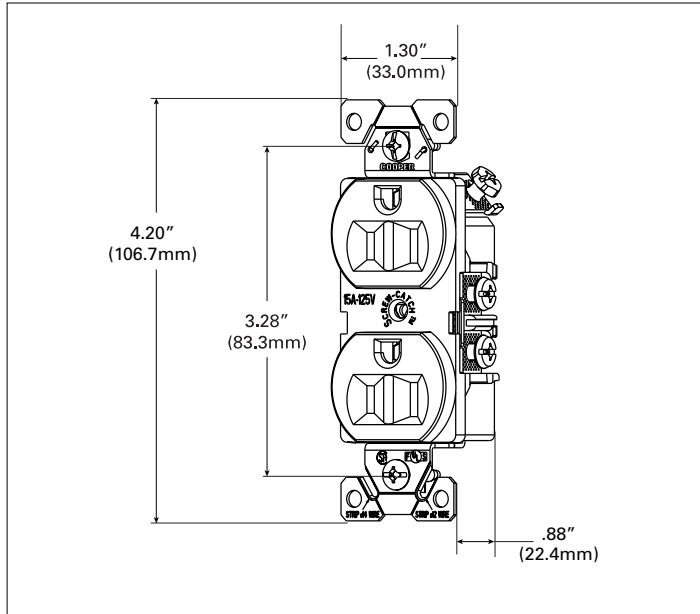

**Figure 1. BR15 Line Art with Dimensions**

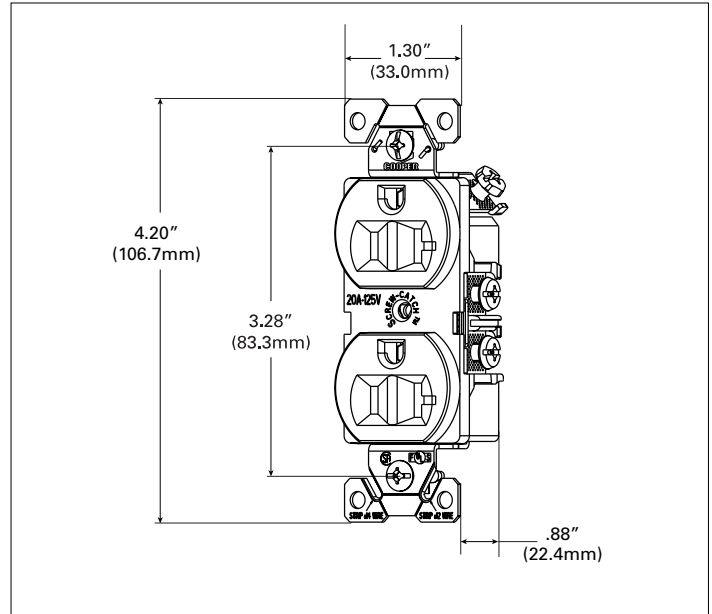

**Figure 2. BR20 Line Art with Dimensions**

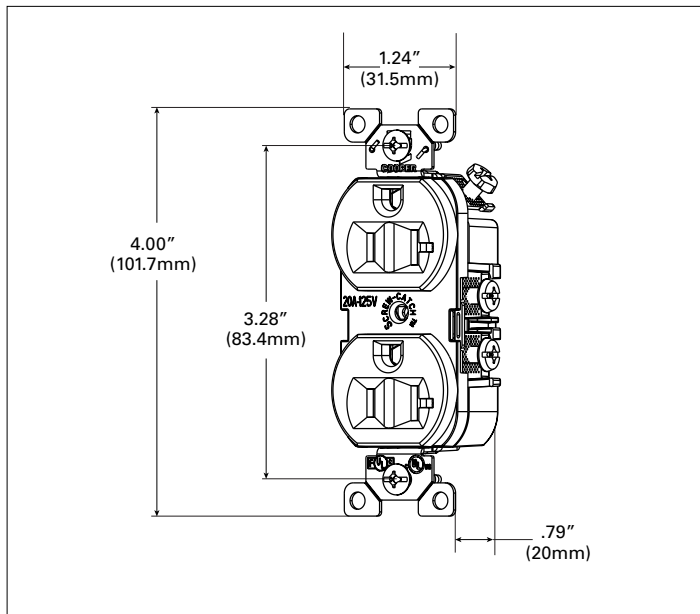

**Figure 3. CR20 Line Art with Dimensions**

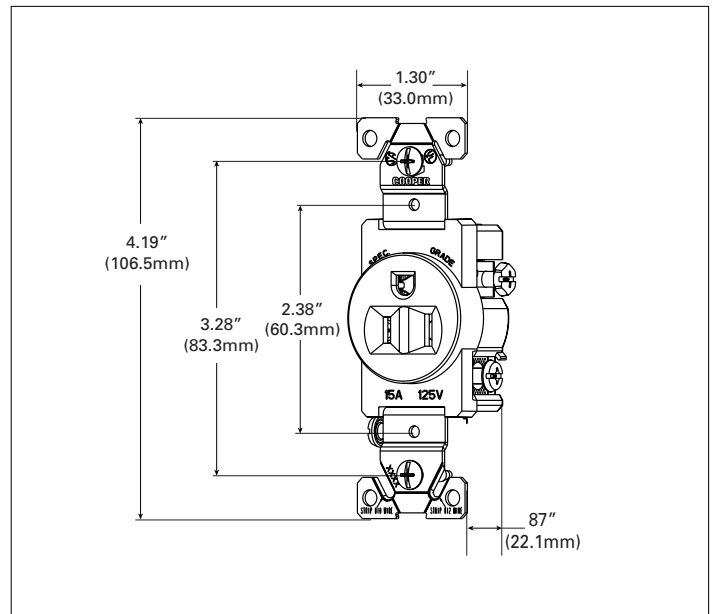

**Figure 4. 817 Line Art with Dimensions**

Project Name:	Prepared By:
Project Number:	Date:
Catalog Number:	Type:

**Product Dimensions**



Figure 5. 1877 Line Art with Dimensions



Figure 6. TRBR15 Line Art with Dimensions

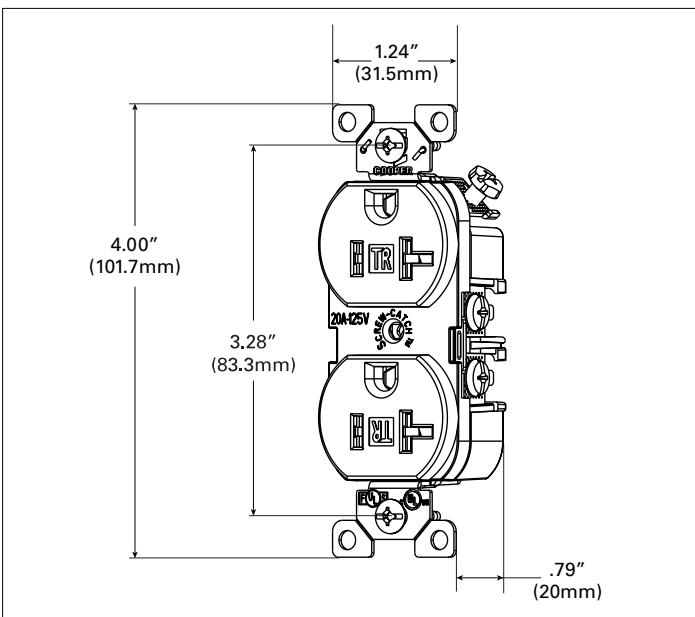

Figure 7. TRBR20 Line Art with Dimensions

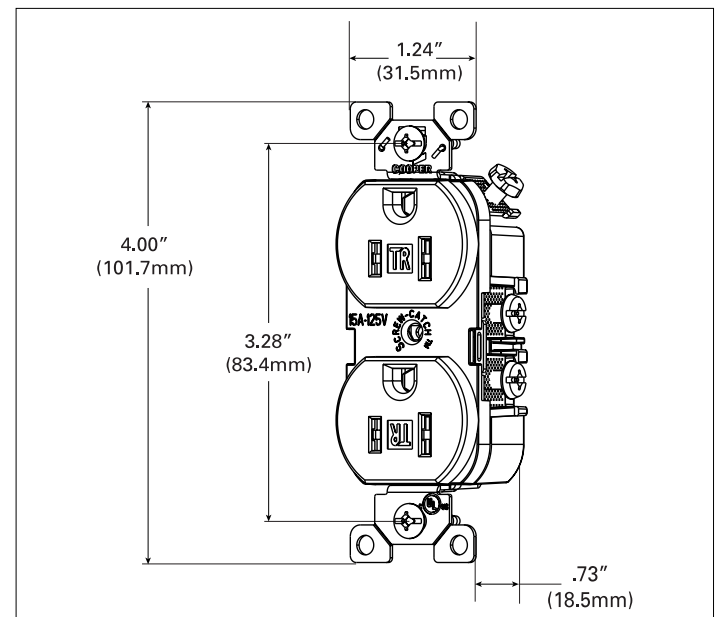
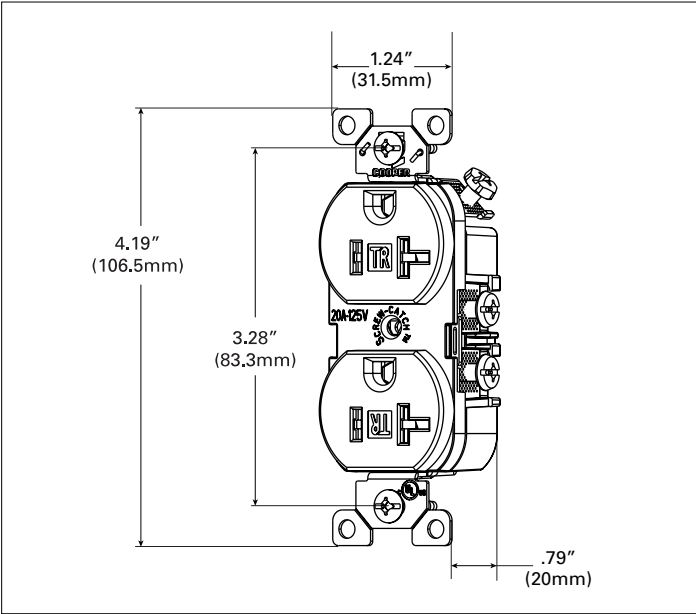

Figure 8. TRCR15 Line Art with Dimensions



Project Name:	Prepared By:
Project Number:	Date:
Catalog Number:	Type:

**Product Dimensions**



**Figure 9. TRCR20 Line Art with Dimensions**

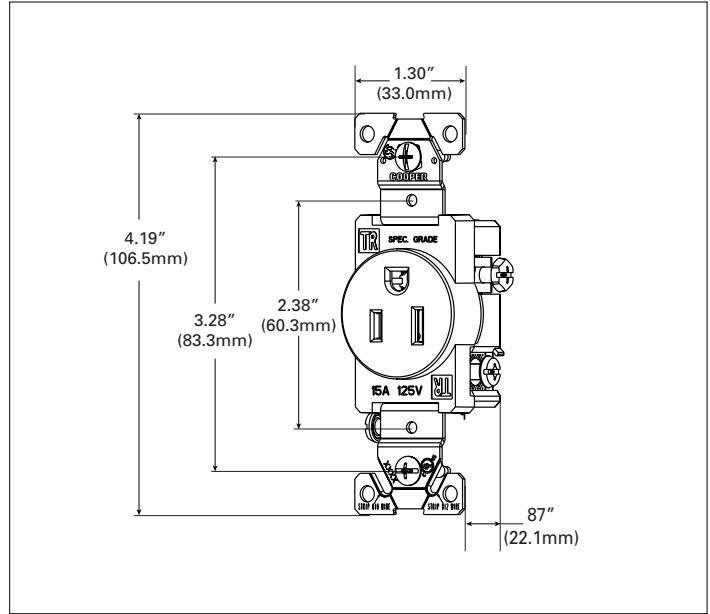



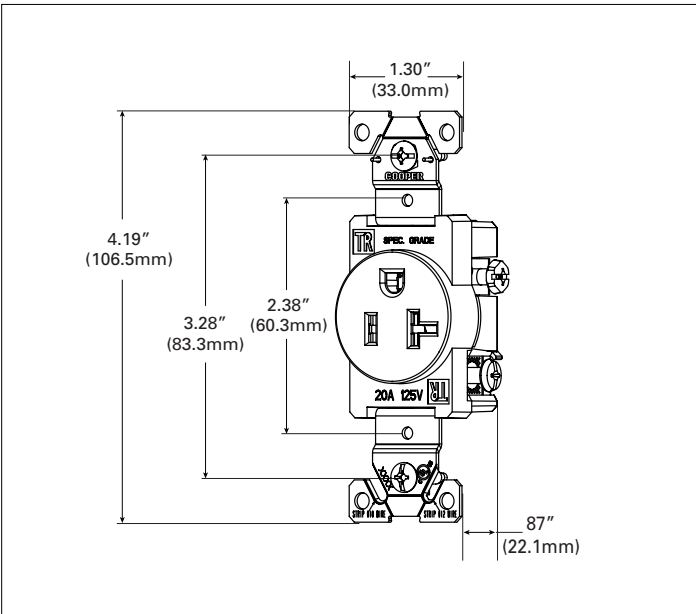





**Figure 10. TR817 Line Art with Dimensions**



**Figure 11. TR1877 Line Art with Dimensions**

Project Name:	Prepared By:
Project Number:	Date:
Catalog Number:	Type:

## Certifications & compliances

Catalog No.									
BR15	•	•	•	•	•	•	•	•	•
CR15	•		•			•		•	•
817		•		•	•	•		•	•
BR20	•	•	•	•	•	•	•	•	•
CR20	•		•			•		•	•
1877		•		•	•	•		•	•
826	•		•			•		•	•
816	•		•			•		•	•
815	•	•	•		•	•		•	•
1876	•		•			•		•	•
829		•	•		•	•		•	•
TRBR15	•		•			•	•	•	•
TRCR15	•					•		•	•
TR817	•		•			•		•	•
TRBR20	•		•			•	•	•	•
TRCR20	•					•		•	•
TR1877	•					•		•	•

**KEY:**  cULus  UL  Fed Spec  NAFTA  CSA  
 NOM  Arrowlink  Build-To-Spec  ROHS

 Parts are manufactured and designed in accordance with article 4 of the European Union's RoHS2 directive 2011/65/EU

 Build-To-Spec Customizable Devices

**Compliances, specifications and availability are subject to change without notice.**

Electrical Sector  
203 Cooper Circle  
Peachtree City, GA 30269  
United States  
Eaton.com  
Eaton.com/arrowhart

Electrical Sector  
Canada Operations  
5925 McLaughlin Road  
Mississauga, Ontario, L5R 1B8  
Canada  
EatonCanada.ca  
Eaton.com/arrowhart

Electrical Sector  
Mexico Operations  
Carr. Tlalnepantla -  
Cuautitlan Km 17.8 s/n  
Col. Villa Jardin esq.  
Cerrada 8 de Mayo  
Cuautitlan, Mexico CP 54800  
Mexico  
Eaton.mx  
Eaton.com/arrowhart