

COOPER LIGHTING - METALUX®

DESCRIPTION

The GR8 is a T8-dedicated lensed troffer designed to offer premium performance in a low profile housing. T8 dedication and optimized lamp to lens spacing provides the best in energy efficiency and optical control. The GR8's shallow, low profile housing is compatible with even highly restrictive plenums. Luminaires are compatible with today's popular ceiling systems. The GR8 offers great performance and great quality. The series is an excellent choice for commercial offices, schools, hospitals, retail merchandising and many other applications.

Catalog #		Type
Project		
Comments		Date
Prepared by		

SPECIFICATION FEATURES

Construction

Unitized low profile recessed housing is die formed of code gauge prime cold rolled steel with full length stiffeners and unibody endplate for added strength. Ballast cover is easily removed without tools. Die formed captive lampholder bracket fully encloses lampholder wiring for easy lampholder replacement. Ample KO's are provided for continuous row wiring. Built-in grid-lock feature for safety and convenience.

Electrical**

Ballasts are CBM/ETL Class "P" and are positively secured by mounting bolts. Rotor-lock T8 lampholders. Biaxial models use 2G11 base lampholders with double-edge wiping action pressure-lock contacts and horizontally oriented lamp support clips. UL/CUL listed. Suitable for damp locations.

Finish

Multistage, iron phosphate pretreatment ensures maximum bonding and rust inhibition. Lighting grade baked white enamel finish with premium reflectance for high efficiency.

Hinging/Latching

Positive spring loaded steel latches and safety lock T-hinges provide secure, high quality door fit and allow hinging and latching from either side.

Frame/Shielding

Heavy gauge flat steel door is die formed with reinforced mitered corners. Housing and door frame assemblies incorporate full width mechanical light traps. Light stabilized, acrylic prismatic lens.

Controls

Fifth Light ballast options are offered for both 0-10V continuous dimming and DALI applications. Combine with energy-saving products like occupancy sensors, daylighting controls, and lighting relay panels from Cooper Controls (www.coopercontrol.com) to maximize energy savings.



2GR8
2U6T8, 2BX40
2U1-5/8
217, 417

2' X 2' TROFFER
2 OR 4 LAMPS

General Purpose
T8 Commercial Troffer

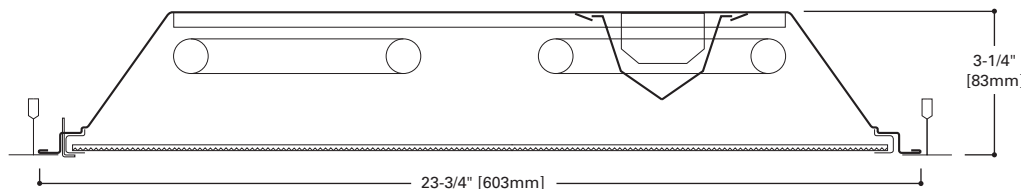

MOUNTING DATA

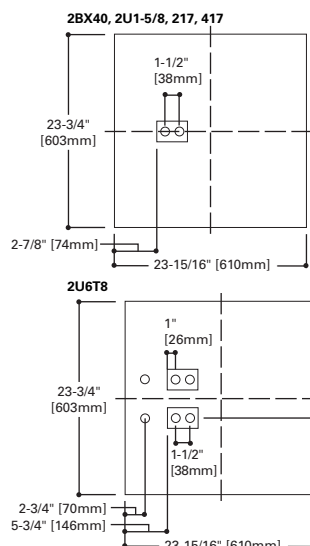

LAMP CONFIGURATIONS

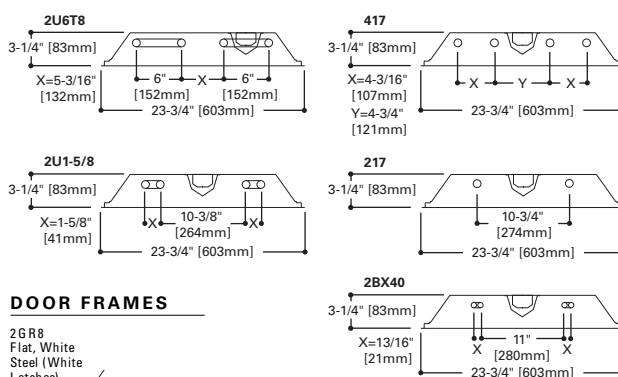

DOOR FRAMES

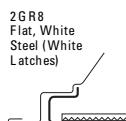

CEILING COMPATIBILITY

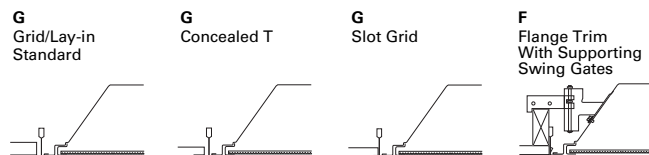

COOPER LIGHTING

Ceiling Type	Trim Type
Exposed Grid	G
Concealed T	G
Slot Grid	G
Flange	G***

ENERGY DATA

Input Watts:
EB Ballast & STD Lamps
217 (36) , 2U1-5/8 (61) , 2U6T8 (61)
417 (63) , 2BX40 (71)

ES Ballast & STD Lamps
217 (45) , 2U1-5/8 (71) , 2U6T8 (71)
417 (90) , 2BX40 (77)

Luminaire Efficacy Rating
LER = FL-73
Catalog Number: 2GR8-2U6T8A

Yearly Cost of 1000 lumens, 3000 hrs at .08 KWH = \$3.29

*Standard G (Grid) Type Fixtures can be field converted by adding trim kits. See Compatibility Section or Consult Factory.

**Reference the lamp/ballast data in the Technical Section for specific lamp/ballast requirements.

***When ordering Flange Kit for installation in drywall ceilings, see options and accessories compatibility section and ordering logic.

LAMPS CONTAIN MERCURY. DISPOSE ACCORDING TO LOCAL, STATE OR FEDERAL LAWS

LINEAR DISCONNECT

Safe and convenient means of disconnecting power.



ADF012705

PHOTOMETRICS

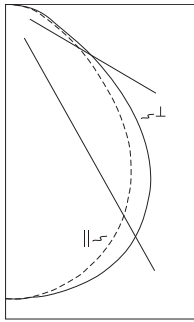

2GR8-2U6T8A
 Electronic Ballast
 (2) 31W U6T8 lamps
 2850 lumens
 Spacing criterion:
 (H) 1.2 x mounting
 height, (L) 1.3 x
 mounting height
 Efficiency 77.1%
 Test Report:
 2GR82U6T8A.IES
 LER = FL-73
 Yearly Cost of 1000
 lumens, 3000 hrs at
 .08 KWH = \$3.29

Candela			
Angle	Along H	45°	Across L
0	1775	1775	1775
5	1771	1769	1773
10	1742	1749	1768
15	1696	1717	1749
20	1629	1672	1719
25	1547	1607	1670
30	1443	1522	1591
35	1317	1406	1486
40	1171	1264	1363
45	996	1075	1195
50	805	877	993
55	638	688	780
60	491	495	574
65	361	330	406
70	271	224	307
75	210	175	245
80	153	146	179
85	82	86	90
90	0	0	0

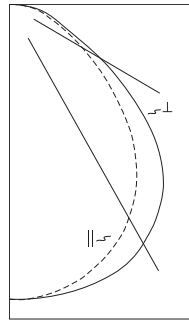

2GR8-217A
 Electronic Ballast
 (2) F32T8 lamps
 1350 lumens
 Spacing criterion:
 (H) 1.2 x mounting
 height, (L) 1.4 x
 mounting height
 Efficiency 75.1%
 Test Report:
 2GR8-217A.IES
 LER = FL-60
 Yearly Cost of 1000
 lumens, 3000 hrs at
 .08 KWH = \$4.00

Candela			
Angle	Along H	45°	Across L
0	795	795	795
5	794	792	796
10	782	785	794
15	763	774	790
20	734	756	781
25	699	731	765
30	652	697	734
35	597	649	695
40	528	586	646
45	449	503	574
50	363	413	478
55	287	325	371
60	220	235	273
65	165	155	189
70	123	104	143
75	96	81	112
80	70	68	82
85	38	39	40
90	0	0	0

Coefficients of Utilization

rc	Effective floor cavity reflectance 20%																								
	80%				70%				50%				30%				10%				0%				
	rw	70	50	30	10	70	50	30	10	50	30	10	50	30	10	50	30	10	50	30	10	50	30	10	0
RCR																									
0	92	92	92	92	90	90	90	90	86	86	86	82	82	82	79	79	79	77							
1	84	81	78	75	82	79	77	74	76	74	72	73	71	69	70	69	67	66							
2	77	72	67	63	75	70	66	62	67	64	60	65	62	59	63	60	58	56							
3	71	63	58	53	69	62	57	52	60	55	51	58	54	51	56	53	50	48							
4	65	57	50	45	64	56	50	45	54	49	45	52	48	44	50	47	43	42							
5	60	51	44	40	59	50	44	39	49	43	39	47	42	39	46	41	38	37							
6	56	46	40	35	55	45	39	35	44	39	34	43	38	34	42	37	34	32							
7	52	42	36	31	51	41	35	31	40	35	31	39	34	30	38	34	30	29							
8	49	38	32	28	47	38	32	28	37	31	28	36	31	27	35	31	27	26							
9	45	35	29	25	44	35	29	25	34	29	25	33	28	25	32	28	25	23							
10	43	33	27	23	42	32	27	23	32	26	23	31	26	23	30	26	22	21							

Zonal Lumen Summary

Zone	Lumens	%Lamp	%Fixture
0-30	1394	24.5	31.7
0-40	2269	39.8	51.6
0-60	3729	65.4	84.8
0-90	4398	77.1	100.0
0-180	4398	77.1	100.0

Luminance Data

Angle in Deg	Average 0-Deg cd/sm	Average 45-Deg cd/sm	Average 90-Deg cd/sm
45	3789	4090	4546
55	2992	3227	3658
65	2298	2100	2584
75	2183	1819	2546
85	2531	2654	2778

Coefficients of Utilization

rc	Effective floor cavity reflectance 20%																								
	80%				70%				50%				30%				10%				0%				
	rw	70	50	30	10	70	50	30	10	50	30	10	50	30	10	50	30	10	50	30	10	50	30	10	0
RCR																									
0	89	89	89	89	87	87	87	87	83	83	83	80	80	80	77	77	77	75							
1	82	79	76	73	80	77	74	72	74	72	70	71	69	68	68	67	66	64							
2	75	70	65	61	73	68	64	60	66	62	59	63	60	57	61	58	56	54							
3	69	62	56	51	67	61	55	51	58	54	50	56	52	49	54	51	48	47							
4	64	55	49	44	62	54	48	44	52	47	43	51	46	43	49	45	42	40							
5	59	49	43	38	57	49	43	38	47	42	38	46	41	37	44	40	37	35							
6	54	45	38	34	53	44	38	34	43	37	33	41	37	33	40	36	33	31							
7	50	41	34	30	49	40	34	30	39	34	30	38	33	29	37	33	29	28							
8	47	37	31	27	46	37	31	27	36	30	27	35	30	26	34	30	26	25							
9	44	34	28	24	43	34	28	24	33	28	24	32	27	24	31	27	24	22							
10	41	32	26	22	40	31	26	22	30	25	22	30	25	22	29	25	22	20							

Zonal Lumen Summary

Zone	Lumens	%Lamp	%Fixture
0-30	631	23.4	31.1
0-40	1035	38.3	51.0
0-60	1718	63.6	84.7
0-90	2027	75.1	100.0
0-180	2027	75.1	100.0

Luminance Data

Angle in Deg	Average 0-Deg cd/sm	Average 45-Deg cd/sm	Average 90-Deg cd/sm
45	2231	2499	2852
55	1758	1991	2273
65	1372	1289	1571
75	1303	1100	1520
85	1532	1572	1613

ORDERING INFORMATION

SAMPLE NUMBER: 2GR8-2U6T8A-UNV-EB81-U

<p>Rating⁽⁴⁾ Blank= Standard ATW-SW4= Chicago Rated</p>	<p>Number of Lamps 2=2 Lamps 4=4 Lamps⁽⁵⁾ (Not included)</p>	<p>Voltage⁽²⁾ 347V=347 Volt UNV=Universal Voltage 120-277⁽³⁾</p>	<p>Ballast Type EB8_=T8 Electronic Start. Total Harmonic Distortion < 10% EB8_/PLUS= T8 Electronic Start. Total Harmonic Distortion < 10%. High Ballast Factor > 1.15. ER8_= T8 Electronic Program Rapid Start. Total Harmonic Distortion < 10% EB5_=T5 Biax Electronic Instant Start. Total Harmonic Distortion < 20%⁽⁶⁾ TEB5_=T5 Biax Electronic Instant Start. Total Harmonic Distortion < 10%⁽⁶⁾ ER5_= T5 Biax Electronic Program Rapid Start. Total Harmonic Distortion < 10% High Performance T8 Ballasts HBB_=T8 Electronic Instant Start. Total Harmonic Distortion < 10%. Standard Ballast Factor .86 - .88 HBB_L=T8 Electronic Instant Start. Total Harmonic Distortion < 10%. Low Ballast Factor .77 - .82 HBB_N=T8 Electronic Instant Start. Total Harmonic Distortion < 10%. Normal Ballast Factor 1.0 HBB_H=T8 Electronic Instant Start. Total Harmonic Distortion < 10%. High Ballast Factor 1.15 - 1.20 HR8_T8 Electronic Program Rapid Start. Total Harmonic Distortion < 10%. Standard Ballast Factor .86 - .88 HR8_DIM=T8 Electronic Program Rapid Start. Total Harmonic Distortion < 10%. Step Dimming. Ballast Factor .88 HR8_L=T8 Electronic Program Rapid Start. Total Harmonic Distortion < 10%. Low Ballast Factor .71 - .79 HR8_H=T8 Electronic Program Rapid Start. Total Harmonic Distortion < 10%. High Ballast Factor 1.15 - 1.20 0-10V Dimming Ballasts⁽¹⁰⁾ 5LTV8_=T8 0-10V Program Rapid Start. Total Harmonic Distortion < 10%. Ballast Factor 0.87^{(14), (15)} 5LTVS8_=T8 0-10V Spec Grade Program Rapid Start. Total Harmonic Distortion < 10%. Ballast Factor 0.87^{(11), (12), (13)} Fifth Light DALI Ballasts⁽⁹⁾ 5LT8_=T8 DALI Program Rapid Start. Total Harmonic Distortion < 10%. Ballast Factor 1.0 5LT5B_= T5 Biax DALI Program Rapid Start. Total Harmonic Distortion < 10%. Ballast Factor 1.0</p>	<p>Options FR=Fire Label</p>	<p>Packaging U=Unit Pack</p>
<p>Width 2=2' Width</p>	<p>Wattage 17=17W T8 (24") U6T8=32W (24")⁽⁷⁾ U1-5/8=31W T8 (24")⁽⁸⁾ BX40=40W Biaxial (24")</p>	<p>Options GL=Single Element Fuse GM=Double Element Fuse Lamps=Lamps Installed Flex=Flex Installed EL=Emergency Installed</p>		<p>ACCESSORIES EQ-CLIP-U=T-BAR Safety Earthquake Clips⁽¹¹⁾ FCTKA-22W-U=Field Installed Flange Kit</p>	
<p>Trim Type G=Grid/Lay-in (Standard)</p>	<p>Shielding A=#12 Acrylic Pattern A125=#12 Pattern Acrylic (.125" Thick) A19/156=#19 Pattern Acrylic (.156" Thick) PB1S=Silver Parabolic Louver Flanged (1/2" x 1/2" x 1/2")</p>	<p>Series R8=General Purpose T8 Commercial Troffer⁽¹⁾</p>	<p>FCTK A - 24 R W - U Trim Kit Field Convertible Aluminum 22=2' x 2' 24=2' x 4' Blank=Single R=In Row E=End Row N=Natural W=White U=Unit Pack</p>		

NOTES: ⁽¹⁾An EQ Grid Clip is recommended for all 9/16" ceiling systems. Four required per fixture. ⁽²⁾Products also available in non-US voltages and frequencies for international markets. ⁽³⁾Not available when specifying emergencies, voltage must be specific. ⁽⁴⁾For NYC rated product, see separate specification sheets. ⁽⁵⁾4-Lamp configuration only available in 17W. ⁽⁶⁾Not available in UNV voltages. Must specify voltage. ⁽⁷⁾Ballast Factor is 0.88 for 4 lamp 32W T8 fixtures. ⁽⁸⁾Fifthlight ballast option not available. ⁽⁹⁾For a complete listing of Fifthlight Technology products and other solutions from Cooper Controls, visit www.coopercontrol.com. ⁽¹⁰⁾0-10V ballast do not include DALI feature. Please select DALI ballast for use with Fifth Light system. ⁽¹¹⁾Specification grade 0-10V dimming ballast are NEMA premium and CEE listed. They are compatible with low mercury and energy saving lamps. ⁽¹²⁾Specification Grade 0-10V ballast not available for Biax lamps. ⁽¹³⁾Specification Grade 0-10V ballast not offered in 3 or 4-lamp versions. ⁽¹⁴⁾Standard 0-10V ballast not available for Biax lamps. ⁽¹⁵⁾Standard 0-10V ballast not offered in 3 or 4-lamp versions

For complete product data, reference the Fluorescent Specification binder. Specifications & dimensions subject to change without notice. Consult your Cooper Lighting Representative for availability and ordering information.

Number of Ballasts
1=1 Ballast
2=2 Ballasts
3=3 Ballasts

SHIPPING INFORMATION

Catalog No.	Wt.
2GR8-217A	12 lbs.
2GR8-417A	12 lbs.
2GR8-2U6T8A	12 lbs.
2GR8-2U1-5/8A	12 lbs.
2GR8-2BX40A	15 lbs.



COOPER LIGHTING - METALUX®

DESCRIPTION

The GR8 is a T8-dedicated lensed troffer designed to offer premium performance in a low profile housing. T8 dedication and optimized lamp to lens spacing provides the best in energy efficiency and optical control. The GR8's shallow, low profile housing is compatible with even highly restrictive plenums. Luminaires are compatible with today's popular ceiling systems. The GR8 offers great performance and great quality. The series is an excellent choice for commercial offices, schools, hospitals, retail merchandising and many other applications.

Catalog #		Type
Project		
Comments		Date
Prepared by		

SPECIFICATION FEATURES

Construction

Unitized low profile recessed housing is die formed of code gauge prime cold rolled steel with full length stiffeners and unibody endplate for added strength. Ballast cover is easily removed without tools. Die formed captive lampholder bracket fully encloses lampholder wiring for easy lampholder replacement. Ample KOs are provided for continuous row wiring. Built-in grid-lock feature for safety and convenience.

Electrical**

Ballasts are CBM/ETL Class "P" and are positively secured by mounting bolts. Rotor-lock T8 lampholders. Biaxial models use 2G11 base lampholders with double-edge wiping action pressure-lock contacts and horizontally oriented lamp support clips. UL/CUL listed. Suitable for damp locations.

Finish

Multistage, iron phosphate pretreatment ensures maximum bonding and rust inhibition. Lighting grade baked white enamel finish with premium reflectance for high efficiency.

Hinging/Latching

Positive spring loaded steel latches and safety lock T-hinges provide secure, high quality door fit and allow hinging and latching from either side.

Frame/Shielding

Heavy gauge flat steel door is die formed with reinforced mitered corners. Housing and door frame assemblies incorporate full width mechanical light traps. Light stabilized, acrylic prismatic lens.

Controls

Fifth Light ballast options are offered for both 0-10V continuous dimming and DALI applications. Combine with energy-saving products like occupancy sensors, daylighting controls, and lighting relay panels from Cooper Controls (www.coopercontrol.com) to maximize energy savings.



2GR8
2U6T8, 2BX40
2U1-5/8
217, 417

2' X 2' TROFFER
2 OR 4 LAMPS

General Purpose
T8 Commercial Troffer

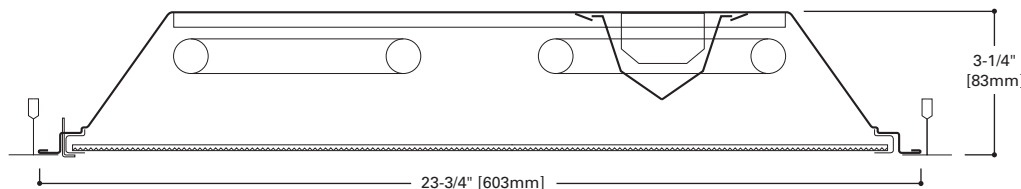

MOUNTING DATA

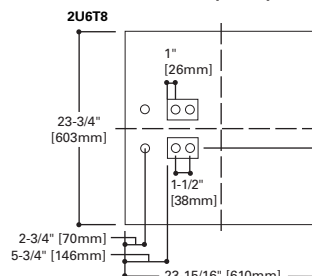
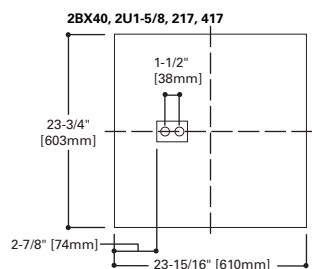

LAMP CONFIGURATIONS

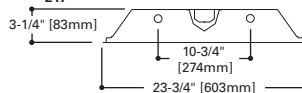
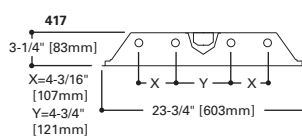
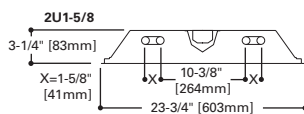
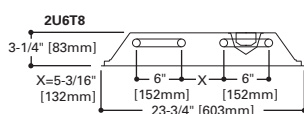

DOOR FRAMES

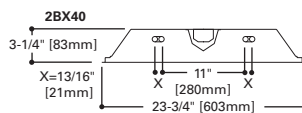
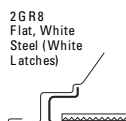

CEILING COMPATIBILITY

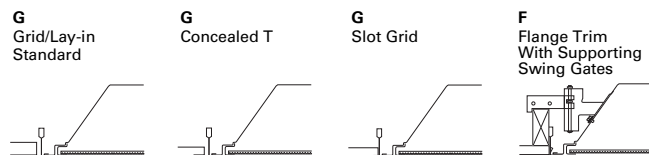

Ceiling Type	Trim Type
Exposed Grid	G
Concealed T	G
Slot Grid	G
Flange	G***

ENERGY DATA

Input Watts:
EB Ballast & STD Lamps
217 (36) , 2U1-5/8 (61), 2U6T8 (61)
417 (63) , 2BX40 (71)

ES Ballast & STD Lamps
217 (45) , 2U1-5/8 (71), 2U6T8 (71)
417 (90), 2BX40 (77)

Luminaire Efficacy Rating
LER = FL-73
Catalog Number: 2GR8-2U6T8A

Yearly Cost of 1000 lumens, 3000 hrs at .08 KWH = \$3.29

*Standard G (Grid) Type Fixtures can be field converted by adding trim kits. See Compatibility Section or Consult Factory.

**Reference the lamp/ballast data in the Technical Section for specific lamp/ballast requirements.

***When ordering Flange Kit for installation in drywall ceilings, see options and accessories compatibility section and ordering logic.

LAMPS CONTAIN MERCURY. DISPOSE ACCORDING TO LOCAL, STATE OR FEDERAL LAWS

LINEAR DISCONNECT
Safe and convenient means of disconnecting power.



PHOTOMETRICS

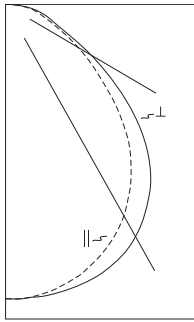

2GR8-2U6T8A
 Electronic Ballast
 (2) 31W U6T8 lamps
 2850 lumens
 Spacing criterion:
 (H) 1.2 x mounting
 height, (L) 1.3 x
 mounting height
 Efficiency 77.1%
 Test Report:
 2GR82U6T8A.IES
 LER = FL-73
 Yearly Cost of 1000
 lumens, 3000 hrs at
 .08 KWH = \$3.29

Candela			
Angle	Along H	45°	Across L
0	1775	1775	1775
5	1771	1769	1773
10	1742	1749	1768
15	1696	1717	1749
20	1629	1672	1719
25	1547	1607	1670
30	1443	1522	1591
35	1317	1406	1486
40	1171	1264	1363
45	996	1075	1195
50	805	877	993
55	638	688	780
60	491	495	574
65	361	330	406
70	271	224	307
75	210	175	245
80	153	146	179
85	82	86	90
90	0	0	0

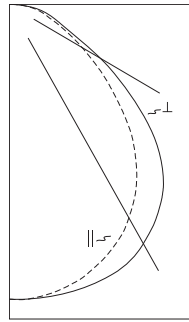

2GR8-217A
 Electronic Ballast
 (2) F32T8 lamps
 1350 lumens
 Spacing criterion:
 (H) 1.2 x mounting
 height, (L) 1.4 x
 mounting height
 Efficiency 75.1%
 Test Report:
 2GR8-217A.IES
 LER = FL-60
 Yearly Cost of 1000
 lumens, 3000 hrs at
 .08 KWH = \$4.00

Candela			
Angle	Along H	45°	Across L
0	795	795	795
5	794	792	796
10	782	785	794
15	763	774	790
20	734	756	781
25	699	731	765
30	652	697	734
35	597	649	695
40	528	586	646
45	449	503	574
50	363	413	478
55	287	325	371
60	220	235	273
65	165	155	189
70	123	104	143
75	96	81	112
80	70	68	82
85	38	39	40
90	0	0	0

Coefficients of Utilization

rc	Effective floor cavity reflectance 20%																									
	80%				70%				50%				30%				10%				0%					
	rw	70	50	30	10	70	50	30	10	50	30	10	50	30	10	50	30	10	50	30	10	50	30	10	50	30
RCR	0	92	92	92	92	90	90	90	90	86	86	86	82	82	82	79	79	79	77	77	77	77	77	77	77	77
1	84	81	78	75	82	79	77	74	76	74	72	73	71	69	70	69	67	66	66	66	66	66	66	66	66	66
2	77	72	67	63	75	70	66	62	67	64	60	65	62	59	63	60	58	56	56	56	56	56	56	56	56	56
3	71	63	58	53	69	62	57	52	60	55	51	58	54	51	56	53	50	48	48	48	48	48	48	48	48	48
4	65	57	50	45	64	56	50	45	54	49	45	52	48	44	50	47	43	42	42	42	42	42	42	42	42	42
5	60	51	44	40	59	50	44	39	49	43	39	47	42	39	46	41	38	37	37	37	37	37	37	37	37	37
6	56	46	40	35	55	45	39	35	44	39	34	43	38	34	42	37	34	32	32	32	32	32	32	32	32	32
7	52	42	36	31	51	41	35	31	40	35	31	39	34	30	38	34	30	29	29	29	29	29	29	29	29	29
8	49	38	32	28	47	38	32	28	37	31	28	36	31	27	35	31	27	26	26	26	26	26	26	26	26	26
9	45	35	29	25	44	35	29	25	34	29	25	33	28	25	32	28	25	23	23	23	23	23	23	23	23	23
10	43	33	27	23	42	32	27	23	32	26	23	31	26	23	30	26	22	21	21	21	21	21	21	21	21	21

Coefficients of Utilization

rc	Effective floor cavity reflectance 20%																									
	80%				70%				50%				30%				10%				0%					
	rw	70	50	30	10	70	50	30	10	50	30	10	50	30	10	50	30	10	50	30	10	50	30	10	50	30
RCR	0	89	89	89	89	87	87	87	83	83	83	80	80	80	77	77	77	75	75	75	75	75	75	75	75	75
1	82	79	76	73	80	77	74	72	74	72	70	71	69	68	68	67	66	64	64	64	64	64	64	64	64	64
2	75	70	65	61	73	68	64	60	66	62	59	63	60	57	61	58	56	54	54	54	54	54	54	54	54	54
3	69	62	56	51	67	61	55	51	58	54	50	56	52	49	54	51	48	47	47	47	47	47	47	47	47	47
4	64	55	49	44	62	54	48	44	52	47	43	51	46	43	49	45	42	40	40	40	40	40	40	40	40	40
5	59	49	43	38	57	49	43	38	47	42	38	46	41	37	44	40	37	35	35	35	35	35	35	35	35	35
6	54	45	38	34	53	44	38	34	43	37	33	41	37	33	40	36	33	31	31	31	31	31	31	31	31	31
7	50	41	34	30	49	40	34	30	39	34	30	38	33	29	37	33	29	28	28	28	28	28	28	28	28	28
8	47	37	31	27	46	37	31	27	36	30	27	35	30	26	34	30	26	25	25	25	25	25	25	25	25	25
9	44	34	28	24	43	34	28	24	33	28	24	32	27	24	31	27	24	22	22	22	22	22	22	22	22	22
10	41	32	26	22	40	31	26	22	30	25	22	30	25	22	29	25	22	20	20	20	20	20	20	20	20	20

Zonal Lumen Summary

Zone	Lumens	%Lamp	%Fixture
0-30	1394	24.5	31.7
0-40	2269	39.8	51.6
0-60	3729	65.4	84.8
0-90	4398	77.1	100.0
0-180	4398	77.1	100.0

Luminance Data

Angle in Deg	Average 0-Deg cd/sm	Average 45-Deg cd/sm	Average 90-Deg cd/sm
45	3789	4090	4546
55	2992	3227	3658
65	2298	2100	2584
75	2183	1819	2546
85	2531	2654	2778

Zonal Lumen Summary

Zone	Lumens	%Lamp	%Fixture
0-30	631	23.4	31.1
0-40	1035	38.3	51.0
0-60	1718	63.6	84.7
0-90	2027	75.1	100.0
0-180	2027	75.1	100.0

Luminance Data

Angle in Deg	Average 0-Deg cd/sm	Average 45-Deg cd/sm	Average 90-Deg cd/sm
45	2231	2499	2852
55	1758	1991	2273
65	1372	1289	1571
75	1303	1100	1520
85	1532	1572	1613

ORDERING INFORMATION

SAMPLE NUMBER: 2GR8-2U6T8A-UNV-EB81-U

<p>Rating⁽⁴⁾ Blank= Standard ATW-SW4= Chicago Rated</p>	<p>Number of Lamps 2=2 Lamps 4=4 Lamps⁽⁵⁾ (Not included)</p>	<p>Voltage⁽²⁾ 347V=347 Volt UNV=Universal Voltage 120-277⁽³⁾</p>	<p>Ballast Type EB8_=T8 Electronic Start. Total Harmonic Distortion < 10% EB8_/PLUS= T8 Electronic Start. Total Harmonic Distortion < 10%. High Ballast Factor > 1.15. ER8_= T8 Electronic Program Rapid Start. Total Harmonic Distortion < 10% EB5_=T5 Biax Electronic Instant Start. Total Harmonic Distortion < 20%⁽⁶⁾ TEB5_=T5 Biax Electronic Instant Start. Total Harmonic Distortion < 10%⁽⁶⁾ ER5_= T5 Biax Electronic Program Rapid Start. Total Harmonic Distortion < 10% High Performance T8 Ballasts HBB_=T8 Electronic Instant Start. Total Harmonic Distortion < 10%. Standard Ballast Factor .86 – .88 HBB_L=T8 Electronic Instant Start. Total Harmonic Distortion < 10%. Low Ballast Factor .77 – .82 HBB_N=T8 Electronic Instant Start. Total Harmonic Distortion < 10%. Normal Ballast Factor 1.0 HBB_H=T8 Electronic Instant Start. Total Harmonic Distortion < 10%. High Ballast Factor 1.15 – 1.20 HR8_T8 Electronic Program Rapid Start. Total Harmonic Distortion < 10%. Standard Ballast Factor .86 – .88 HR8_DIM=T8 Electronic Program Rapid Start. Total Harmonic Distortion < 10%. Step Dimming. Ballast Factor .88 HR8_L=T8 Electronic Program Rapid Start. Total Harmonic Distortion < 10%. Low Ballast Factor .71 – .79 HR8_H=T8 Electronic Program Rapid Start. Total Harmonic Distortion < 10%. High Ballast Factor 1.15 – 1.20 0-10V Dimming Ballasts⁽¹⁰⁾ 5LTV8_=T8 0-10V Program Rapid Start. Total Harmonic Distortion < 10%. Ballast Factor 0.87^{(14), (15)} 5LTVS8_=T8 0-10V Spec Grade Program Rapid Start. Total Harmonic Distortion < 10%. Ballast Factor 0.87^{(11), (12), (13)} Fifth Light DALI Ballasts⁽⁹⁾ 5LT8_=T8 DALI Program Rapid Start. Total Harmonic Distortion < 10%. Ballast Factor 1.0 5LT5B_= T5 Biax DALI Program Rapid Start. Total Harmonic Distortion < 10%. Ballast Factor 1.0</p>	<p>Options FR=Fire Label</p>	<p>Packaging U=Unit Pack</p>
<p>Width 2=2' Width</p>	<p>Wattage 17=17W T8 (24") U6T8=32W (24")⁽⁷⁾ U1-5/8=31W T8 (24")⁽⁸⁾ BX40=40W Biaxial (24")</p>	<p>Options GL=Single Element Fuse GM=Double Element Fuse Lamps=Lamps Installed Flex=Flex Installed EL=Emergency Installed</p>	<p>ACCESSORIES EQ-CLIP-U=T-BAR Safety Earthquake Clips⁽¹¹⁾ FCTKA-22W-U=Field Installed Flange Kit</p>		
<p>Trim Type G=Grid/Lay-in (Standard)</p>	<p>Shielding A=#12 Acrylic Pattern A125=#12 Pattern Acrylic (.125" Thick) A19/156=#19 Pattern Acrylic (.156" Thick) PB1S=Silver Parabolic Louver Flanged (1/2" x 1/2" x 1/2")</p>		<p>FCTK A - 24 R W - U Trim Kit Field Convertible Aluminum 22=2' x 2' 24=2' x 4' Blank=Single R=In Row E=End Row N=Natural W=White U=Unit Pack</p>		
<p>Series R8=General Purpose T8 Commercial Troffer⁽¹⁾</p>					

NOTES: ⁽¹⁾An EQ Grid Clip is recommended for all 9/16" ceiling systems. Four required per fixture. ⁽²⁾Products also available in non-US voltages and frequencies for international markets. ⁽³⁾Not available when specifying emergencies, voltage must be specific. ⁽⁴⁾For NYC rated product, see separate specification sheets. ⁽⁵⁾4-Lamp configuration only available in 17W. ⁽⁶⁾Not available in UNV voltages. Must specify voltage. ⁽⁷⁾Ballast Factor is 0.88 for 4 lamp 32W T8 fixtures. ⁽⁸⁾Fifthlight ballast option not available. ⁽⁹⁾For a complete listing of Fifthlight Technology products and other solutions from Cooper Controls, visit www.coopercontrol.com. ⁽¹⁰⁾0-10V ballast do not include DALI feature. Please select DALI ballast for use with Fifth Light system. ⁽¹¹⁾Specification grade 0-10V dimming ballast are NEMA premium and CEE listed. They are compatible with low mercury and energy saving lamps. ⁽¹²⁾Specification Grade 0-10V ballast not available for Biax lamps. ⁽¹³⁾Specification Grade 0-10V ballast not offered in 3 or 4-lamp versions. ⁽¹⁴⁾Standard 0-10V ballast not available for Biax lamps. ⁽¹⁵⁾Standard 0-10V ballast not offered in 3 or 4-lamp versions

For complete product data, reference the Fluorescent Specification binder. Specifications & dimensions subject to change without notice. Consult your Cooper Lighting Representative for availability and ordering information.

Number of Ballasts
1=1 Ballast
2=2 Ballasts
3=3 Ballasts

SHIPPING INFORMATION

Catalog No.	Wt.
2GR8-217A	12 lbs.
2GR8-417A	12 lbs.
2GR8-2U6T8A	12 lbs.
2GR8-2U1-5/8A	12 lbs.
2GR8-2BX40A	15 lbs.

