



Cutler-Hammer

Motor Control Center Type Series 2100/5 Star

Renewal Parts

Supersedes RPD Supplement 8991c
pages 1-28, dated May 1998

Description

Page

Motor Control Center Type Series 2100/5 Star

Distributor Ordering Instructions	2
Procedure for Identifying MCC Renewal Units and Parts	2
Identifying Motor Control Center Types	3
Identification by Original Handle Mechanism	3
Procedure for Identifying Motor Control Center Types	4
Series 2100/5 Star Product Description	5
Replacement Starter Units	6 – 15
Unit Options	16 – 18
Structure Parts	19 – 22
Unit Parts	23 – 24
Series C Retrofit Kits	25
Replacement Feeder Units (All Vintages)	27

MCC Type	Dates	Cutler-Hammer Renewal Parts Publication
F2100 Advantage™ Series 2100	1995 – 1992 – 1987 – 95	RP04304001E RP04304002E RP04304003E
5 Star Freedom Unitrol F10 Unitrol	1975 – 87 1988 – 94 1972 – 89	RP04304003E RP04304004E RP04304005E
Type W 9800 Unitrol 11-300	1965 – 75 1956 – 74 1935 – 65	RP04304006E RP04304007E RP04304008E

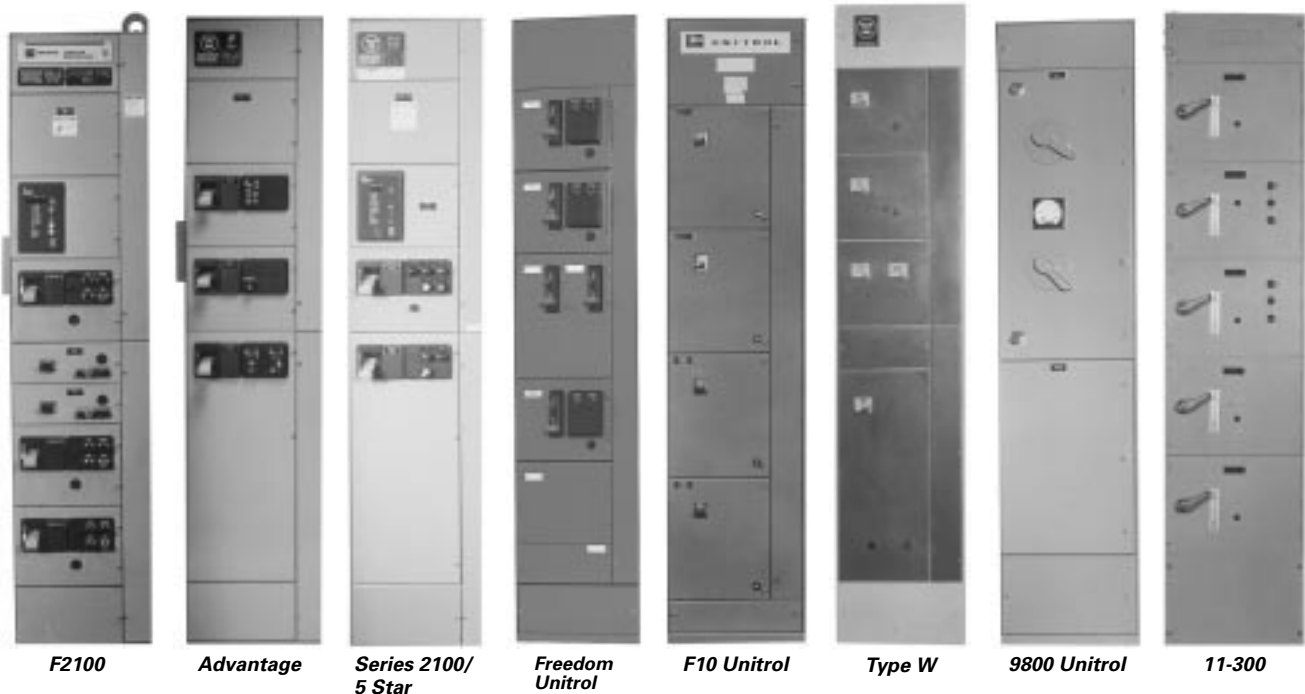

F2100

Advantage

Series 2100/
5 Star

Freedom
Unitrol

F10 Unitrol

Type W

9800 Unitrol

11-300

Identifying Motor Control Center Types

In most cases, it is possible to identify MCC design by handle type. Starter type, bucket width and door width can assist in identification.

Table 1. Identifying Motor Control Center Types

MCC Type	Type of Handle Mechanism	Original MCC Starter Type	Bucket Width Inches (mm)	Door Width Inches (mm)	Original Manufacturer ①	Starter Type (Installed in New Unit)
F2100 ②	Lever	Freedom Series	13-3/4 (349.3)	15-5/8 (397.0)	Cutler-Hammer 1994 to Present	Freedom
Advantage ②	Lever	Advantage	13-3/4 (349.3)	15-5/8 (397.0)	Westinghouse until 1994 Cutler-Hammer 1994 to Present	Advantage
Series 2100 ②	Lever	A200	13-3/4 (349.3)	15-5/8 (397.0)	Westinghouse until 1994 Cutler-Hammer 1994 to Present	A200
5 Star ②	Lever	A200	13-3/4 (349.3)	15-5/8 (397.0)	Westinghouse 1975 – 1987	A200
Freedom Unitrol	Slider	Freedom Series	13-7/8 (352.5)	15-1/2 (393.7)	Cutler-Hammer 1988 – 1994	Freedom
F10 Unitrol	Slider and Lever	Citation	14 (355.6)	14-3/4 (374.7) w/ Wireway 19-1/2 (495.3) w/o Wireway	Cutler-Hammer 1972 – 1989	Freedom
Type W	Slider	A200 or 11-200	11-3/4 (298.5)	13-3/8 (339.9)	Westinghouse 1965 – 1975	A200
9800 Unitrol	Rotary ③	3 Star/Citation	16-1/8 (409.7)	19-3/8 (492.3)	Cutler-Hammer 1956 – 1974	Freedom
11-300	Rotary	11-200 Lifeline Type N/A200	15-3/4 (400.1)	20 (508.0)	Westinghouse 1950 – 1965	A200

① MCC types were sometimes produced outside the time spans shown. This was due to the overlap of production when a new design was adopted.

② The unit “wrappers” are mechanically identical for these designs.

③ 9800 originally was supplied with Rotary. New replacement units are manufactured with slider handle mechanism.

Identification by Original Handle Mechanism



*F2100, Advantage,
Series 2100/5 Star*



Freedom Unitrol



*F10 Unitrol Slider
9800 Unitrol*



*F10 Unitrol Lever
and 9800 Unitrol*



Type W



9800 Unitrol

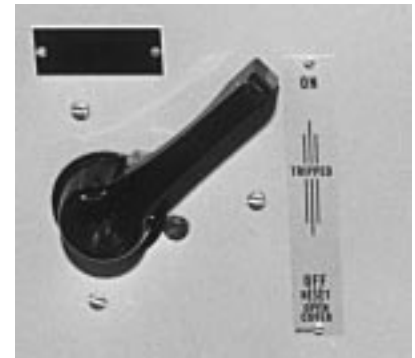

11-300

Procedure for Identifying Motor Control Center Types

In the event that the nameplate is missing, it is possible to identify the MCC design by the type of handle mechanism, starter type, bucket width and door width.

Table 2. Identifying Motor Control Center Types

MCC Type	Type of Handle Mechanism	Starter Type	Bucket Width Inches (mm)	Door Width Inches (mm)	Cutler-Hammer Renewal Parts Publication
F2100 Advantage Series 2100	Lever Lever Lever	Freedom Series Advantage A200	13-3/4 (349.3) 13-3/4 (349.3) 13-3/4 (349.3)	15-5/8 (397.0) 15-5/8 (397.0) 15-5/8 (397.0)	RP04304001E RP04304002E RP04304003E
5 Star Freedom Unitrol F10 Unitrol	Lever Slider Lever/Slider	A200 Freedom Series Citation	13-3/4 (349.3) 13-7/8 (352.5) 14 (355.6)	15-5/8 (397.0) 15-1/2 (393.7) 14-3/4 (374.7) w/ Wireway or 19-1/2 (495.3) w/o Wireway	RP04304003E RP04304004E RP04304005E
Type W 9800 Unitrol 11-300	Slider Rotary Rotary	A200 or 11-200 3 Star and/or Citation 11-200 Lifeline N and/or A200	11-3/4 (298.5) 16-1/8 (409.7) 15-3/4 (400.1)	13-3/8 (339.9) 19-3/8 (492.3) 20 (508.0)	RP04304006E RP04304007E RP04304008E



F2100

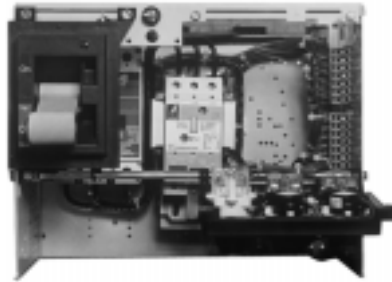

Advantage



Series 2100/5 Star

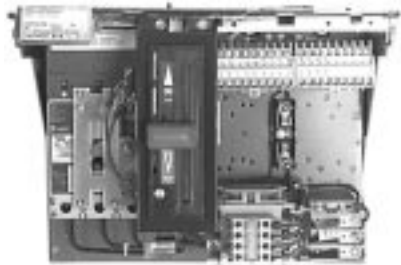

Freedom Unitrol

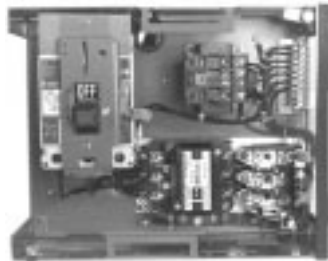

F10 Unitrol



Type W



9800 Unitrol



11-300

**Series 2100/5 Star
Product Description**

Introduced in 1975, the Westinghouse 5 Star MCC was the basis for the Series 2100 and Advantage designs. The vertical structures are normally 20 inches (508.0 mm) wide, 90 inches (2286.0 mm) high and 16 inches (406.4) or 21 inches (533.4 mm) deep. Vertical sections may be bolted together forming a single lineup with continuous horizontal bus and open horizontal wireways. Unit height is measured in 6 inch (152.4 mm) increments, up to a maximum of 72 inches (1828.8 mm) of usable vertical space.

A two-tone light/dark enamel paint system is used for this design. Ferro white is applied to the structural framework and units. ANSI 61 gray is applied to the roof and side sheets and all exterior doors. Starter units are 13-3/4 inches (349.3 mm) wide.

The Series 2100/5 Star starter unit's handle mechanism is a gray toggle type handle with a black exterior mounting panel and is used on the Advantage and Freedom 2100 designs. Bus and bus support systems are typically braced to withstand fault currents of 42,000A on the 5 Star and 65,000A on the Series 2100.

Table 3. 2100 Product Rating

Maximum Ratings
3-Phase, 600V, 600 hp, 3200A Bus



**Series F2100
Structure**



Series F2100 Starter Unit

Series 2100/5 Star Replacement Starter Units

How to Order

When ordering a replacement unit, you receive:

- Series C® HMCP.
- A200 Starter.
- Unit options as specified.
- New steel wrapper, door and handle mechanism.
- New stabs.
- UL® label.

Use the following steps for creating a catalog number for your specific application:

Step 1

Select the correct replacement unit from **Pages 6 – 27**. When selecting, you need to know the following:

- MCC type.
- Class of Unit (FVNR, FVR, Reduced Voltage — Autotransformer or Part Winding or Solid State, FV – 2 Speed, 1 Winding or 2 Speed, 2 Winding, etc.).
- Starter size or horsepower rating.
- Protection device (breaker or fusible).
- Service voltage.
- Control voltage.
- Space required.

Step 2

Verify required space is available.

Step 3

Create a catalog number by selecting Catalog Codes from the columns per the example given.

Step 4

Add modifications as required from the Unit Options on **Pages 16 – 18**. Space available determines allowable options.

Table 4. Catalog Numbering System Example

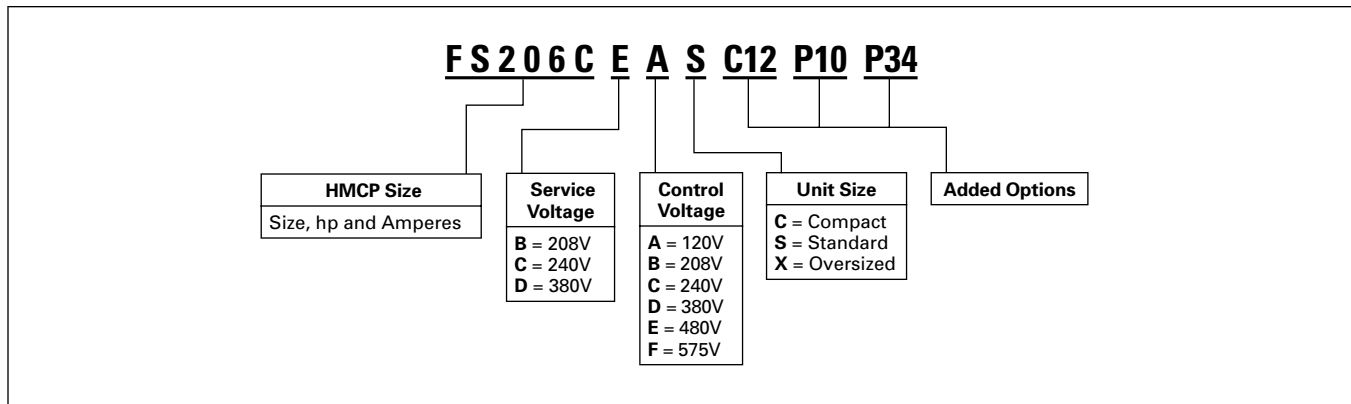

Table 5. Full Voltage Non-Reversing Combination Starter — HMCP (Must specify if HMCPE is required)

NEMA® Size	Maximum Horsepower					HMCP Size	Catalog Code	Service Voltage	Catalog Code	Control Voltage	Catalog Code	Space Options Inches (mm)	Catalog Code
	208V	240V	380V	480V	600V								
1	0.5	0.33	1	1	1.5	3	FS206A FS206B FS206C FS206D	208	B C D E F	120	A B C D E F	12 (304.8) High 18 (457.2) High	S X
	1	1	2	3	3	7		240		208			
	3	3	5	7.5	7.5	15		380		240			
	7.5	7.5	10	10	10	30		480		380			
								575		480			
2	10	15	25	25	25	50	FS206E	208	B C D E F	120	A B C D E F	12 (304.8) High 18 (457.2) High	S X
								240		208			
								380		240			
								480		380			
								575		480			
3	25	30	50	50	50	100	FS206H	208	B C D E F	120	A B C D E F	18 (457.2) High 24 (609.6) High	S X
								240		208			
								380		240			
								480		380			
								575		480			
4	40	50	75	100	100	150	FS206L	208	B C D E F	120	A B C D E F	18 (457.2) High 24 (609.6) High	S X
								240		208			
								380		240			
								480		380			
								575		480			
5	60	60	125	150	150	250	FS206P FS206R	208	B C D E F	120	A B C D E F	36 (914.4) High	S
	75	100	150	200	200	400		240		208			
								380		240			
								480		380			
								575		480			

Series 2100/5 Star Replacement Starter Units

Table 6. Full Voltage Reversing Combination Starter — HMCP

NEMA Size	Maximum Horsepower					HMCP Size	Catalog Code	Service Voltage	Catalog Code	Control Voltage	Catalog Code	Space Options Inches (mm)	Catalog Code
	208V	240V	380V	480V	600V								
1	0.5	0.33	1	1	1.5	3	FS216A FS216B FS216C FS216D	208	B C D E F	120	A B C D E F	18 (457.2) High 24 (609.6) High	S X
	1	1	2	3	3	7		240		208			
	3	3	5	7.5	7.5	15		380		240			
	7.5	7.5	10	10	10	30		480		380			
								575		480			
575	575						575						
2	10	15	25	25	25	50	FS216E	208	B C D E F	120	A B C D E F	18 (457.2) High 24 (609.6) High	S X
								240		208			
								380		240			
								480		380			
								575		480			
3	25	30	50	50	50	100	FS216H	208	B C D E F	120	A B C D E F	24 (609.6) High	S
								240		208			
								380		240			
								480		380			
								575		480			
4	40	50	75	100	100	150	FS216L	208	B C D E F	120	A B C D E F	24 (609.6) High	S
								240		208			
								380		240			
								480		380			
								575		480			
5	50	60	100	125	150	250	FS216P FS216R	208	B C D E F	120	A B C D E F	54 (1371.6) High	S
	75	100	150	200	200	400		240		208			
								380		240			
								480		380			
								575		480			

Table 7. Full Voltage 2 Speed 1 Winding — Constant/Variable Torque — HMCP ①

NEMA Size	Maximum Horsepower					HMCP Size	Catalog Code	Service Voltage	Catalog Code	Control Voltage	Catalog Code	Space Options Inches (mm)	Catalog Code
	208V	240V	380V	480V	600V								
1	0.5	0.33	1	1	1.5	3	FS946A FS946B FS946C FS946D	208	B C D E F	120	A B C D E F	18 (457.2) High 24 (609.6) High	S X
	1	1	2	3	3	7		240		208			
	3	3	5	7.5	7.5	15		380		240			
	7.5	7.5	10	10	10	30		480		380			
								575		480			
575	575						575						
2	10	15	25	25	25	50	FS946E	208	B C D E F	120	A B C D E F	18 (457.2) High 24 (609.6) High	S X
								240		208			
								380		240			
								480		380			
								575		480			
3	25	30	50	50	50	100	FS946H	208	B C D E F	120	A B C D E F	42 (1066.8) High	S
								240		208			
								380		240			
								480		380			
								575		480			
4	40	50	75	100	100	150	FS946L	208	B C D E F	120	A B C D E F	42 (1066.8) High	S
								240		208			
								380		240			
								480		380			
								575		480			
5	60	60	125	150	150	250	FS946P FS946R	208	B C D E F	120	A B C D E F	42 (1066.8) High	S
	75	100	150	200	200	400		240		208			
								380		240			
								480		380			
								575		480			

① For constant horsepower instead of constant/variable torque, see Option SV6 on Page 18.

Series 2100/5 Star Replacement Starter Units

Table 8. Full Voltage 2 Speed 2 Winding — Constant/Variable Torque — HMCP ①

NEMA Size	Maximum Horsepower					HMCP Size	Catalog Code	Service Voltage	Catalog Code	Control Voltage	Catalog Code	Space Options Inches (mm)	Catalog Code								
	208V	240V	380V	480V	600V																
1	0.5	0.33	1	1	1.5	3	FS956A	208	B	120	A	18 (457.2) High 24 (609.6) High	S								
	1	1	2	3	3	7	FS956B	240	C	208	B		X								
	3	3	5	7.5	7.5	15	FS956C	380	D	240	C										
	7.5	7.5	10	10	10	30	FS956D	480	E	380	D										
													575	F	480	E					
2	10	15	25	25	25	50	FS956E	208	B	120	A	18 (457.2) High 24 (609.6) High					S				
	10	15	25	25	25	50	FS956E	240	C	208	B		X								
														380	D	240	C				
																		480	E	380	D
3	25	30	50	50	50	100	FS956H	208	B	120	A	30 (762.0) High	S								
	25	30	50	50	50	100	FS956H	240	C	208	B										
													380	D	240	C					
																	480	E	380	D	
																					575
4	40	50	75	100	100	150	FS956L	208	B	120	A	30 (762.0) High	S								
	40	50	75	100	100	150	FS956L	240	C	208	B										
													380	D	240	C					
																	480	E	380	D	
																					575
5	50	60	100	125	150	250	FS956P	208	B	120	A	54 (1371.6) High	S								
	75	100	150	200	200	400	FS956R	240	C	208	B										
													380	D	240	C					
																	480	E	380	D	
																					575

① For constant horsepower instead of constant/variable torque, see Option SV6 on Page 18.

Table 9. Reduced Voltage Autotransformer — HMCP

NEMA Size	Maximum Horsepower					HMCP Size	Catalog Code	Service Voltage	Catalog Code	Control Voltage	Catalog Code	Space Options Inches (mm)	Catalog Code							
	208V	240V	380V	480V	600V															
2	10	15	25	25	25	50	FS606E	208	B	120	A	36 (914.4) High	S							
	10	15	25	25	25	50	FS606E	240	C	208	B									
													380	D	240	C				
																	480	E	380	D
3	25	30	50	50	50	100	FS606H	208	B	120	A	54 (1371.6) High	S							
	25	30	50	50	50	100	FS606H	240	C	208	B									
													380	D	240	C				
																	480	E	380	D
4	40	50	75	100	100	150	FS606L	208	B	120	A	54 (1371.6) High	S ②							
	40	50	75	100	100	150	FS606L	240	C	208	B									
													380	D	240	C				
																	480	E	380	D
5	50	60	100	125	150	250	FS606P	208	B	120	A	72 (1828.8) High	S ②							
	75	100	150	200	200	400	FS606R	240	C	208	B									
													380	D	240	C				
																	480	E	380	D

② If existing MCC is back-to-back design, 36 inches (914.4 mm) in bottom rear is unusable.

Series 2100/5 Star Replacement Starter Units

Table 10. Reduced Voltage Part Winding — HMCP

NEMA Size	Maximum Horsepower					HMCP Size	Catalog Code	Service Voltage	Catalog Code	Control Voltage	Catalog Code	Space Options Inches (mm)	Catalog Code
	208V	240V	380V	480V	600V								
1	10	10	15	15	15	30	FS706D	208 240 380 480 575	B C D E F	120 208 240 380 480 575	A B C D E F	18 (457.2) High	S
2	20	25	40	40	40	100	FS706F	208 240 380 480 575	B C D E F	120 208 240 380 480 575	A B C D E F	18 (457.2) High	S
3	40	50	75	75	75	150	FS706J	208 240 380 480 575	B C D E F	120 208 240 380 480 575	A B C D E F	30 (762.0) High	S
4	—	—	—	100	125	150	FS706L	208 240	B C D E F	120 208	A B C D E F	36 (914.4) High	S
	75	75	150	150	150	250	FS706M	240 380 480 575		240 380 480 575		48 (1219.2) High	S
5	100 150	125 150	— 250	250 350	300 250	400 600	FZ706R FZ706T	208 240 380 480 575	B C D E F	120 208 240 380 480 575	A B C D E F	72 (1828.8) High	S

Table 11. Reduced Voltage Wye Delta Open Transition — HMCP

NEMA Size	Maximum Horsepower					HMCP Size	Catalog Code	Service Voltage	Catalog Code	Control Voltage	Catalog Code	Space Options Inches (mm)	Catalog Code
	208V	240V	380V	480V	600V								
2	20	25	40	40	40	100	FS806F	208 240 380 480 575	B C D E F	120 208 240 380 480 575	A B C D E F	30 (762.0) High	S
3	40	50	75	75	75	150	FS806J	208 240 380 480 575	B C D E F	120 208 240 380 480 575	A B C D E F	42 (1066.8) High	S
4	60 —	75 —	125 150	150 —	150 —	250 400	FS806M FS806N	208 240 380 480 575	B C D E F	120 208 240 380 480 575	A B C D E F	54 (1371.6) High	S
5	100 150	125 150	200 250	250 350	300 —	400 600	FS806R FS806T	208 240 380 480 575		B C D E F		120 208 240 380 480 575	A B C D E F

Series 2100/5 Star Replacement Starter Units

Table 12. Reduced Voltage Wye Delta Closed Transition — HMCP (Non-Chiller Application)

NEMA Size	Maximum Horsepower					HMCP Size	Catalog Code	Service Voltage	Catalog Code	Control Voltage	Catalog Code	Space Options Inches (mm)	Catalog Code
	208V	240V	380V	480V	600V								
2	20	25	40	40	40	100	FS896F	208 240 380 480 575	B C D E F	120 208 240 380 480 575	A B C D E F	30 (762.0) High	S
3	40	50	50	50	50	100	FS896J	208 240 380 480 575	B C D E F	120 208 240 380 480 575	A B C D E F	42 (1066.8) High	S
4	60 —	75 —	125 150	150 —	150 —	250 400	FS896M FS896N	208 240 380 480 575	B C D E F	120 208 240 380 480 575	A B C D E F	60 (1524.0) High	S
5	100 150	125 150	200 250	250 300	300 —	400 600	FS896R FS896T	208 240 380 480 575	B C D E F	120 208 240 380 480 575	A B C D E F	72 (1828.8) High	S

IT06 — Intelligent Technologies *IT*. Solid-State Reduced Voltage Starter — HMCP

The *IT*. solid-state reduced voltage starter uses SCRs when starting and a low impedance run circuit during operation. Solid-state starters have (5) 24V dc inputs and 2 relay outputs. Soft start units include a disconnect, starter, 24V dc power supply and 100VA CPT.

Motor Service Factor (SF) Effect on *IT*. Starter Selection

- A 1.0 service factor motor may draw up to 1.00 x full load amperes.
- A 1.15 service factor motor may draw up to 1.15 x full load amperes.
- 15% more current. *IT*. starters are current rated devices. In some cases, a larger *IT*. SSRV starter must be supplied for 1.15 SF motors. See the maximum horsepower chart below.

Note: Most motors used in industrial applications are 1.15 Service Factor (SF).

Table 13. Replacement *IT*. Soft Start Units

Service Factor	Horsepower	<i>IT</i> . Soft-Start Amperes	HMCP Amperes	Catalog Code	Service Voltage	Catalog Code	Control Voltage	Catalog Code	Space Options	Catalog Code
1.15	10	37	100	FS306A	208	B	120	A	12 (304.8) High	S
	15	66	150	FS306B			208	B		
	30	105		FS306C			240	C	18 (457.2) High	
	40	135	FS306D	380			D			
	50	180	400	FS306E			480	E	36 (914.4) High	
	60	240		FS306F			575	F		
	75	304		FS306G			—	—		
1.15	10	37	100	FS306A	240	C	120	A	12 (304.8) High	S
	20	66	150	FS306B			208	B		
	30	105		FS306C			240	C	18 (457.2) High	
	40	135	FS306D	380			D			
	60	180	250	FS306E			480	E	36 (914.4) High	
	75	240		FS306F			575	F		
	100	304		FS306G			—	—		
1.15	15	37	100	FS306A	380	D	120	A	12 (304.8) High	S
	30	66	150	FS306B			208	B		
	45	105		FS306C			240	C	18 (457.2) High	
	55	135	250	FS306D			380	D		
	75	180		400			FS306E	480	E	
	110	240	FS306F				575	F		
	132	304	600	FS306G			—	—		

Series 2100/5 Star Replacement Starter Units

Table 13. Replacement *IT* Soft Start Units (Continued)

Service Factor	Horsepower	<i>IT</i> Soft-Start Amperes	HMCP Amperes	Catalog Code	Service Voltage	Catalog Code	Control Voltage	Catalog Code	Space Options	Catalog Code
1.15	20	37	100	FS306A	480	E	120	A	12 (304.8) High	S
	40	66		FS306B			208	B		
	60	105		FS306C			240	C		
	75	135	FS306D	380			D			
	125	180	400	FS306E			480	E	36 (914.4) High	
	150	240		FS306F			575	F		
	200	304		FS306G			—	—		
—	—	—		—	—					
1.15	30	37	100	FS306A	575	F	120	A	12 (304.8) High	S
	50	66		FS306B			208	B		
	75	105		FS306C			240	C		
	100	135	FS306D	380			D			
	150	180	250	FS306E			480	E	36 (914.4) High	
	200	240		FS306F			575	F		
	250	304	400	FS306G			—	—		
	—	—		—			—	—		

Table 14. Full Voltage Non-Reversing — Fusible ①

NEMA Size	Maximum Horsepower					Fuse Clip Amperes	Catalog Code	Service Voltage	Catalog Code	Control Voltage	Catalog Code	Space Options Inches (mm)	Catalog Code
	208V	240V	380V	480V	600V								
1	7.5	7.5	10	10	10	30	FS204C	208 240 380 480 575	B C D E F	120 208 240 380 480 575	A B C D E F	12 (304.8) High 18 (457.2) High	S X
2	— 10	— 15	15 25	15 25	25 —	30 60	FS204E FS204F	208 240 380 480 575	B C D E F	120 208 240 380 480 575	A B C D E F	12 (304.8) High 18 (457.2) High	S X
3	— 25	20 30	30 50	40 50	50 —	60 100	FS204H FS204J	208 240 380 480 575	B C D E F	120 208 240 380 480 575	A B C D E F	24 (609.6) High	S
4	— 50	— 50	— 50	60 100	75 100	100 200	FS204L FS204M	208 240 380 480 575	B C D E F	120 208 240 380 480 575	A B C D E F	48 (1219.2) High	S
5	60 100	60 100	100 150	150 200	150 200	200 400	FS204P FS204R	208 240 380 480 575	B C D E F	120 208 240 380 480	A B C D E	60 (1524.0) High	S

① Fuse clip ratings shown are based on Class RK1, 5 fuses.

Series 2100/5 Star Replacement Starter Units

Table 15. Full Voltage Reversing — Fusible ①

NEMA Size	Maximum Horsepower					Fuse Clip Amperes	Catalog Code	Service Voltage	Catalog Code	Control Voltage	Catalog Code	Space Options Inches (mm)	Catalog Code			
	208V	240V	380V	480V	600V											
1	7.5	7.5	10	10	10	30	FS214C	208	B	120	A	18 (457.2) High	S			
								240						C	208	B
								380						D	240	C
								480						E	380	D
								575						F	480	E
								575						F	575	F
2	— 10	— 15	15 25	15 25	25 —	30 60	FS214E FS214F	208	B	120	A	18 (457.2) High	S			
								240						C	208	B
								380						D	240	C
								480						E	380	D
								575						F	480	E
								575						F	575	F
3	— 25	20 30	30 50	40 50	50 —	60 100	FS214H FS214J	208	B	120	A	30 (762.0) High	S			
								240						C	208	B
								380						D	240	C
								480						E	380	D
								575						F	480	E
								575						F	575	F
4	— 50	— 50	— 60	60 100	75 100	100 200	FS214L FS214M	208	B	120	A	48 (1219.2) High	S			
								240						C	208	B
								380						D	240	C
								480						E	380	D
								575						F	480	E
								575						F	575	F
5	60 100	60 100	100 150	150 200	150 200	200 400	FS214P FS214R	208	B	120	A	72 (1828.8) High	S			
								240						C	208	B
								380						D	240	C
								480						E	380	D
								575						F	480	E
								575						F	575	F

① Fuse clip ratings shown are based on Class RK1, 5 fuses.

Table 16. Full Voltage Non-Reversing Vacuum Starters — Fusible ②

NEMA Size	Maximum Horsepower					Fuse Clip Amperes	Catalog Code	Service Voltage	Catalog Code	Control Voltage	Catalog Code	Space Options Inches (mm)	Catalog Code			
	208V	240V	380V	480V	600V											
4	— 50	— 50	— 60	60 100	75 100	100 200	FSV04L FSV04M	208	B	120	A	36 (914.4) High	S			
								240						C	208	B
								380						D	240	C
								480						E	380	D
								575						F	480	E
								575						F	575	F
5	60 100	60 100	100 150	150 200	150 200	200 400	FSV04P FSV04R	208	B	120	A	60 (1524.0) High	S			
								240				C		208	B	
								380				D		240	C	
	100	100	150	200	200	400	FSV04R	480	D	380	D	72 (1828.8) High	S			
								575				E		480	E	
								575				F		575	F	

② Fuse clip ratings shown are based on Class RK1, 5 fuses.

Series 2100/5 Star Replacement Starter Units

Table 17. Full Voltage 2 Speed 1 Winding — Fusible — Constant/Variable Torque ①②

NEMA Size	Maximum Horsepower					Fuse Clip Amperes	Catalog Code	Service Voltage	Catalog Code	Control Voltage	Catalog Code	Space Options Inches (mm)	Catalog Code
	208V	240V	380V	480V	600V								
1	7.5	7.5	10	10	10	30	FS944C	208 240 380 480 575	B C D E F	120 208 240 380 480 575	A B C D E F	18 (457.2) High 24 (609.6) High	S X
2	— 15	— 15	15 25	15 25	25 —	30 60	FS944E FS944F	208 240 380 480 575	B C D E F	120 208 240 380 480 575	A B C D E F	24 (609.6) High 30 (762.0) High	S X
3	— 25	20 30	30 50	40 50	50 —	60 100	FS944H FS944J	208 240 380 480 575	B C D E F	120 208 240 380 480 575	A B C D E F	42 (1066.8) High	S
4	— 50	— 50	— 60	60 100	75 100	100 200	FS944L FS944M	208 240 380 480 575	B C D E F	120 208 240 380 480 575	A B C D E F	54 (1371.6) High	S

① Fuse clip ratings shown are based on Class RK1, 5 fuses.

② For constant horsepower instead of constant/variable torque, see option SV6 on Page 18.

Table 18. Full Voltage 2 Speed 2 Winding — Fusible – Constant/Variable Torque ③④

NEMA Size	Maximum Horsepower					Fuse Clip Amperes	Catalog Code	Service Voltage	Catalog Code	Control Voltage	Catalog Code	Space Options Inches (mm)	Catalog Code
	208V	240V	380V	480V	600V								
1	7.5	7.5	10	10	10	30	FS954C	208 240 380 480 575	B C D E F	120 208 240 380 480 575	A B C D E F	18 (457.2) High 24 (609.6) High	S X
2	— 15	— 15	15 25	15 25	25 —	30 60	FS954E FS954F	208 240 380 480 575	B C D E F	120 208 240 380 480 575	A B C D E F	24 (609.6) High 30 (762.0) High	S X
3	— 25	20 30	30 60	40 50	50 —	60 100	FS954H FS954J	208 240 380 480 575	B C D E F	120 208 240 380 480 575	A B C D E F	36 (914.4) High	S
4	— 50	— 50	— 60	60 100	75 100	100 200	FS954L FS954M	208 240 380 480 575	B C D E F	120 208 240 380 480 575	A B C D E F	54 (1371.6) High	S

③ Fuse clip ratings shown are based on Class RK1, 5 fuses.

④ For constant horsepower instead of constant/variable torque, see Option SV6 on Page 18.

Series 2100/5 Star Replacement Starter Units

Table 19. Reduced Voltage Autotransformer — Fusible ①

NEMA Size	Maximum Horsepower					Fuse Clip Amperes	Catalog Code	Service Voltage	Catalog Code	Control Voltage	Catalog Code	Space Options Inches (mm)	Catalog Code
	208V	240V	380V	480V	600V								
2	—	—	15	15	25	30 60	FS604E FS604F	208 240 380 480 575	B C D E F	120 208 240 380 480 575	A B C D E F	36 (914.4) High	S
	10	15	25	25	—								
3	—	20	30	40	50	60 100	FS604H FS604J	208 240 380 480 575	B C D E F	120 208 240 380 480 575	A B C D E F	60 (1524.0) High	S
	25	30	50	50	—								
4	—	—	—	60	75	100 200	FS604L FS604M	208 240 380 480 575	B C D E F	120 208 240 380 480 575	A B C D E F	72 (1828.8) High	S ②
	50	50	60	100	100								

① Fuse clip ratings shown are based on Class RK1, 5 fuses.

② If existing MCC is Back-to-Back design, 36 inches (914.4 mm) in bottom rear is unusable.

Table 20. Reduced Voltage Part Winding — Fusible ③

NEMA Size	Maximum Horsepower					Fuse Clip Amperes	Catalog Code	Service Voltage	Catalog Code	Control Voltage	Catalog Code	Space Options Inches (mm)	Catalog Code
	208V	240V	380V	480V	600V								
2	10	10	15	15	60	60	FS704D	208 240 380 480 575	B C D E F	120 208 240 380 480 575	A B C D E F	24 (609.6) High	S
	—	—	—	—	—								
2	—	15	25	30	40	60 200	FS704F FS704G	208 240 380 480 575	B C D E F	120 208 240 380 480 575	A B C D E F	24 (609.6) High	S
	20	25	40	40	—							30 (762.0) High	S
3	—	—	—	50	60	100 200	FS704J FS704K	208 240 380 480 575	B C D E F	120 208 240 380 480 575	A B C D E F	48 (1219.2) High	S
	40	50	75	75	75								
4	50	—	100	100	150	200 400	FS704M FS704N	208 240 380 480 575	B C D E F	120 208 240 380 480 575	A B C D E F	54 (1371.6) High	S
	75	75	150	150	—								

③ Fuse clip ratings shown are based on Class RK1, 5 fuses.

Series 2100/5 Star Replacement Starter Units

Table 21. Reduced Voltage Wye Delta Open Transition — Fusible ①

NEMA Size	Maximum Horsepower					Fuse Clip Amperes	Catalog Code	Service Voltage	Catalog Code	Control Voltage	Catalog Code	Space Options Inches (mm)	Catalog Code
	208V	240V	380V	480V	600V								
2	15	15	30	40	40	60	FS804F	208	B	120	A	30 (762.0) High	S
	20	25	40	—	—	100	FS804G	240 380 480 575	C D E F	208 240 380 480 575	B C D E F	36 (914.4) High	S
3	25	30	50	60	75	100	FS804J	208	B	120	A	36 (914.4) High	S
	40	50	75	75	—	200	FS804K	240 380 480 575	C D E F	208 240 380 480 575	B C D E F	48 (1219.2) High	S
4	50	60	100	125	150	200	FS804M	208	B	120	A	48 (1219.2) High	S
	60	75	150	150	—	400	FS804N	240 380 480 575	C D E F	208 240 380 480 575	B C D E F	72 (1828.8) High	S

① Fuse clip ratings shown are based on Class RK1, 5 fuses.

Table 22. Reduced Voltage Wye Delta Closed Transition — Fusible (Non-Chiller Application) ②

NEMA Size	Maximum Horsepower					Fuse Clip Amperes	Catalog Code	Service Voltage	Catalog Code	Control Voltage	Catalog Code	Space Options Inches (mm)	Catalog Code
	208V	240V	380V	480V	600V								
2	15	15	30	40	40	60	FS894F	208	B	120	A	30 (762.0) High	S
	20	25	40	—	—	100	FS894G	240 380 480 575	C D E F	208 240 380 480 575	B C D E F	36 (914.4) High	S
3	25	30	50	60	75	100	FS894J	208	B	120	A	48 (1219.2) High	S
	40	50	75	75	—	200	FS894K	240 380 480 575	C D E F	208 240 380 480 575	B C D E F		
4	50	60	100	125	150	200	FS894M	208	B	120	A	60 (1524.0) High	S
	60	75	150	150	—	400	FS894N	240 380 480 575	C D E F	208 240 380 480 575	B C D E F	72 (1828.8) High	S

② Fuse clip ratings shown are based on Class RK1, 5 fuses.

Series 2100/5 Star Unit Options

Table 23. Option Groups ①

Groups	Description	Page Number
A	Advantage Options	16
B	Circuit Breaker Options	16
C	Control Power Source Options	16
G	Ground Fault Protection Options	17
M	Metering Options	17
O	Overload Options	17
P	Pilot Device Options	17
R	Relay and Timer (Control, Voltage, Current) Options	18
S	Starter Contact Options	18
SV	Vacuum Starter Options	18
T	Terminal Block Options	18
U	Unit Wiring Options	18

① Select your option suffix and attach it to the end of the catalog number.

Table 24. Option Suffix

Suffix	Description	Space Required ②
--------	-------------	------------------

A — Advantage Options

A10	Substitute Advantage Starter Size 1	③
A11	Substitute Advantage Starter Size 2	③
A12	Substitute Advantage Starter Size 3	③
A13	Substitute Advantage Starter Size 4	③
A14	Substitute Advantage Starter Size 5	C ③④
A15	Advantage Hand/Off/Auto ACM for FVNR or RVNR Starters	C ④
A16	Advantage Stop/Start for FVNR or RVNR Starters	C ④
A17	Advantage Hand/Off/Auto-Start/Stop ACM for FVNR or RVNR Starters	C ④
A18	Advantage Fast/Slow/Stop 2-Speed Starters	C ④
A19	Advantage Forward/Reverse/Stop for Reversing Starters	C ④
A20	Advantage Fast/Slow/Off/Auto for 2-Speed Starters	C ④
A21	Advantage Forward/Reverse/Off/Auto for Reversing Starters	C ④
A22	ACM Metering Module	C ④
A23	WBELL Form C Bell Alarm Contact	C ④
A24	Reset with Overload Alarm and Trip Indication	C ④
A25	120V ac PLC Circuit Compatible Load Resistor	C ④
A26	WPONI PowerNet Communications Module	C ④
A27	Advantage Status Only ACM	C ④
A28	WPONIDNA DeviceNet Communications Module	C ④

B — Breaker Options

B10	Shunt Trip 120V AC Wired to Terminal Blocks for Remote Tripping	C
B11	Auxiliary Switch Form C (1NO/1NC) Wired to Terminal Blocks	C
B12	Form C Bell Alarm Contact (1NO/1NC) Wired to Terminal Blocks	C
B13	Undervoltage Release	C
B14	IQ Energy Sentinel — F Frame	③
B15	IQ Energy Sentinel — J Frame	③
B16	IQ Energy Sentinel — K Frame	③
B17	IQ Central Energy Display	③
B18	Thermal Magnetic Circuit Breaker Instead of HMCP	—

C — Control Power Source Options

C10	Control Fuse Wired for Separate Source in Lieu of Control Power Transformer	C
C11	Control Fuse with Disconnect for Separate Source in Lieu of Control Power Transformer	C
C12	Control Power Transformer 100 VA for Size 1 and 2 Starters (Fused)	C ④
C13	Control Power Transformer 150 VA for Size 3 and 4 Starters (Fused)	C
C14	Control Power Transformer 100 VA with Interposing Relay for Size 5 Starters, Fused	C
C15	Extra 50 VA for Control Power Transformer	S
C16	Extra 100 VA for Control Power Transformer	S
C17	Service Voltage Control, Fused in Lieu of Control Power Transformer	C
C18	Full Capacity Control Power Transformer for Size 5 Starters, Fused	C

② Minimum unit size required (refer to Replacement Unit pages).

③ Consult factory for spacing.

④ Not available in 6 inches (152.4 mm).

Series F2100/5 Star Unit Options

Table 24. Option Suffix (Continued)

Suffix	Description	Space Required ^①
G — Ground Fault Protection Options		
G10	Class 1 Ground Fault Protection — GRT1 Size 1 – 4	X
G11	Class 1 Ground Protection — GRT1 Size 5 – 6	X
G12	Ground Fault Test Panel	X
M — Metering Options		
M10	Mini Voltmeter	C ^②
M11	Mini Ammeter with Current Transformer	S
M12	Mini Elapsed Time Meter	C ^②
M13	Current Transformer for Remote Metering	S
M14	Current Transducer 4-20 mA Output	X
O — Overload Options		
O10	IQ 500 Solid-State Overload Relay	—
O11	IQ 500 Load Protection Module	—
O16	Bell Alarm (1NO) Wired	C
O17	Bi-Metallic Overload Substitution	C
O18	Adjustable A200 Overload Substitution	C
O19	Overload Relay Heater/Heater Pack	C
O20	CEP7 Solid-State Overload Relay	C
P — Pilot Device Options ^③		
P10	Red "RUN" Light	C
P11	Green "STOPPED" Light	C
P12	Amber "OVERLOAD TRIPPED" Light	C
P13	Green "RUN" Light	C
P14	Red "STOPPED" Light	C
P15	Red "RUN" Push-to-Test Light	C
P16	Green "STOPPED" Push-to-Test Light	C
P17	Amber "OVERLOAD TRIPPED" Push-to-Test Light	C
P18	Green "RUN" Push-to-Test Light	C
P19	Red "STOPPED" Push-to-Test Light	C
P20	Special Function Light	C
P30	"START" Pushbutton	C
P31	"STOP" Pushbutton	C
P32	"START/STOP" Pushbutton	C
P33	"ON" Pushbutton	C
P34	"OFF" Pushbutton	C
P35	"ON/OFF" Pushbutton	C
P36	"FORWARD/REVERSE/STOP" Pushbutton	C
P37	"FAST/SLOW/STOP" Pushbutton	C
P38	"FAST/OFF/SLOW" Pushbutton	C
P39	"HIGH/LOW/STOP" Pushbutton	C
P40	"HIGH/LOW/OFF" Pushbutton	C
P41	Special Function Pushbutton	C
P50	"ON-OFF" Selector Switch	C
P51	"HIGH-LOW" Selector Switch	C
P52	"OFF-AUTO" Selector Switch	C
P53	"START-STOP" Selector Switch	C
P54	"SLOW-FAST" Selector Switch	C
P55	"FORWARD-REVERSE" Selector Switch	C
P56	Special Function 2-Position Selector Switch	C
P57	"HAND-OFF-AUTO" Selector Switch	C
P58	"LOCAL-OFF-REMOTE" Selector Switch	C
P59	"FAST-OFF-SLOW" Selector Switch	C
P60	"HIGH-OFF-LOW" Selector Switch	C
P61	Special Function 3-Position Selector Switch	C
P62	"HIGH-LOW-OFF-AUTO" Selector Switch	C
P63	Special Function 4-Position Selector Switch	C

^① Minimum unit size required (refer to Replacement Unit pages).

^② Customer to supply range of meter required.

^③ Available only with F2100, Advantage, Series 2100/5 Star, Freedom Unitrol, F10 Unitrol and Type W. Consult factory for specific size limitations.

Series F2100/5 Star Unit Options

Table 24. Option Suffix (Continued)

Suffix	Description	Space Required ^①						
R — Relay and Timer Options								
R10	Auxiliary Control Relay 2-Pole (1NO/1NC) Convertible Contacts Wired in Parallel with Starter Coil	S						
R11	Auxiliary Control Relay 4-Pole (2NO/2NC) Convertible Contacts Wired in Parallel with Starter Coil	S						
R12	Auxiliary Control Relay 2-Pole Overload Alarm (1NO/1NC) Convertible Contacts	S						
R13	Mechanical Latching Relay (Specify Connection)	X						
R14	Ice Cube Relay 300 Volts 3-Pole Blade Type (Specify Connection)	S						
R15	Phase Voltage Relay	X						
R16	Current Sensing Relay with Contacts Wired to Terminal Blocks	X						
R17	Deceleration Timing Relay (Pneumatic "OFF" Delay)	S						
R18	Compelling Timing Relay (Pneumatic "ON" Delay)	S						
R19	Time Clock 24 Hour	②						
R20	Time Clock 7 Day	②						
R21	Solid-State Timer Type TR (Specify Connection)	S						
R22	DN65 DeviceNet Interface Module	S						
R23	D15 2-Pole Control Relay	C						
R24	D15 4-Pole Control Relay	C						
S — Starter Contact Options (Maximum of 8 Contacts)								
S__	To order extra starter contacts, you must specify the number of NO/NC contacts, given a maximum of eight (8). To define the unit option required, create a suffix based on the following example:							
	<table border="1" style="margin-left: 40px;"> <thead> <tr> <th></th> <th>Quantity of Normally Open Contacts</th> <th>Quantity of Normally Closed Contacts</th> </tr> </thead> <tbody> <tr> <td>S</td> <td>2</td> <td>3</td> </tr> </tbody> </table>		Quantity of Normally Open Contacts	Quantity of Normally Closed Contacts	S	2	3	
	Quantity of Normally Open Contacts	Quantity of Normally Closed Contacts						
S	2	3						
SV — Vacuum Starter Options								
SV4	Vacuum Starter Size 4 Substitution FVNR	②						
SV5	Vacuum Starter Size 5 Substitution FVNR	②						
SV6	Constant Horsepower Instead of Constant/Variable Torque	—						
T — Terminal Block Options								
T10	Pull-apart Type Terminal Blocks (Standard on all Vintages Except Type W and 11-300)	S						
T11	Utility Screw Type Terminal Blocks (Add 6 Inches (152.4 mm) for Every 18 Points)	—						
T12	Front-mounted Pull-apart Terminal Block for F2100, Advantage, Series 2100/5 Star	S						
T13	T-Lead Power Terminal Blocks for Size 1 Starter	—						
U — Unit Wiring Options								
U10	Surge Suppressor on Coil	C						
U11	Type SIS Control Wire	C						
U12	Type SIS Power Wire	C						
U13	Type 14 Gauge Control Wire (Standard for all Vintages Except F2100, Series 2100/5 Star, Type W and 11-300)	C						
U14	Wiremarkers — Sleeve Type on all Control Wire	C						
U15	Locking Fork Terminals on all Control Wiring	S						
U16	Ring Wire Terminals on Power Wiring	S						
U17	Wiring Diagram Inside Starter Unit Door	C						
U18	Pre-insulated Ring Terminals on all Control Wiring	C						
U19	Pre-insulated Ring Terminals on all Control Wiring, except for Freedom Starter Terminals	C						
U20	Wiremarkers for Power Wiring	C						

① Minimum unit size required (refer to Replacement Unit pages).

② Consult factory for spacing.

Series 2100/5 Star Structure Parts

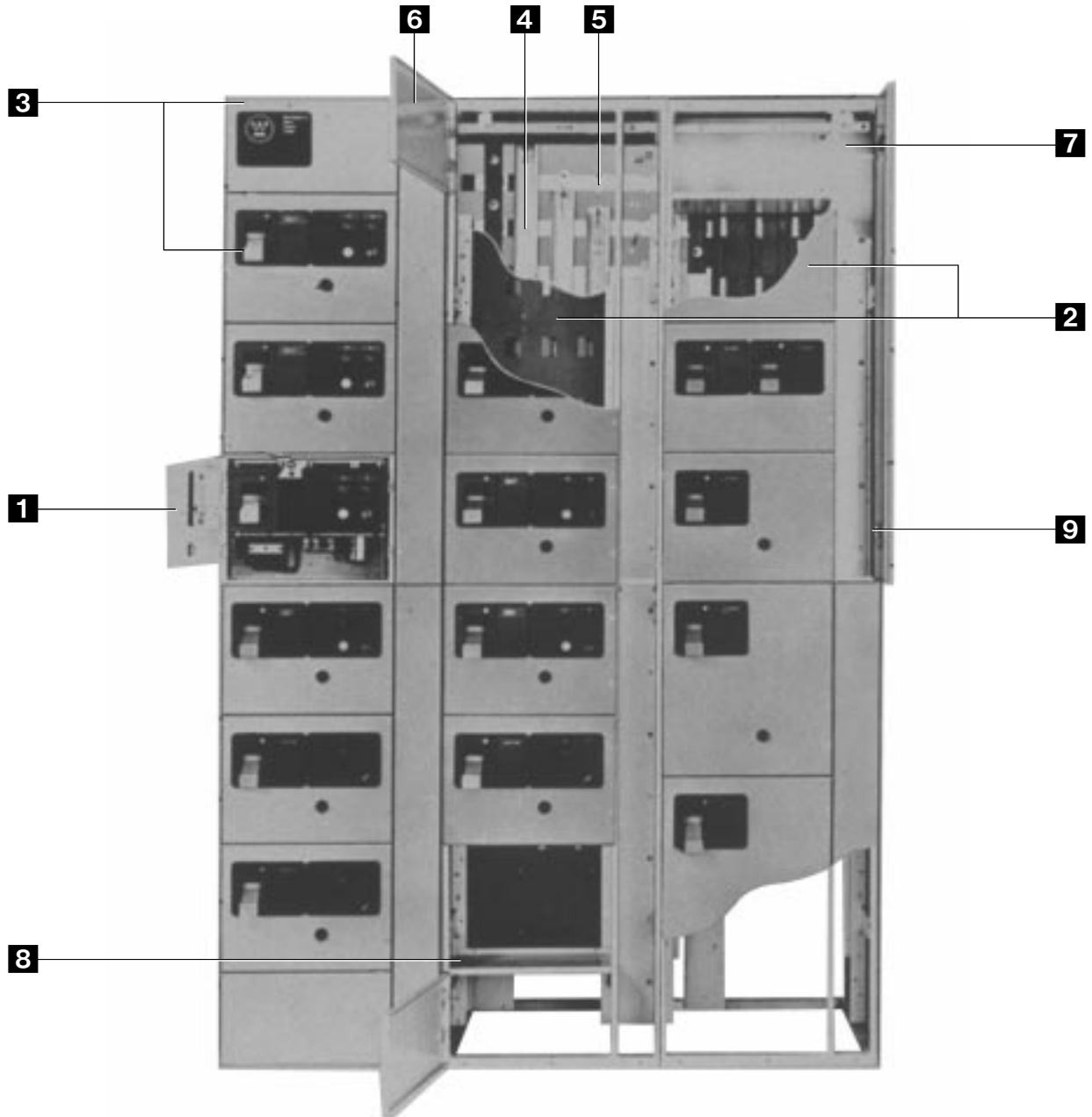

Table 25. Structure Parts

Reference	Description	Page
1	Blank Unit Door	20
2	Vertical Bus Barrier Kit Shutter Kit	20 20
3	Top and Side Sheet Metal Covers Touch-up Paint Kit	20 20
4	Vertical Bus Bar Vertical Bus Insulation Kit	20 20
5	Horizontal Bus Bar	21

Reference	Description	Page
6	Horizontal Wireway Door Kit	21
7	Horizontal Bus Barriers	21
8	Divider Pan/Guide Rails	21
9	Vertical Wireway Door Kit Horizontal to Vertical Bus Connection Kit Horizontal Bus Insulator Kit Horizontal Bus Splice Kit Door Mounting Hardware Kit	21 22 22 22 22

**Series 2100/5 Star
Structure Parts**

Vertical Bus Bar ❷

65,000 ampere rms bus bracing

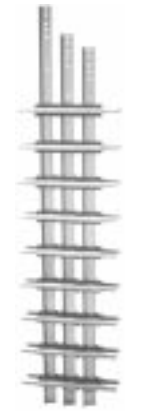

Vertical Bus Bar

Table 26. Vertical Bus Bar — Copper Only

Ampere Rating	Mounting Type	Style Number
300	Front	4719A80G01
600	Front/Back-to-Back	4719A80G02
800	Front	4719A80G04
1200	Front	4719A80G05

Vertical Bus Barrier Kits ❷

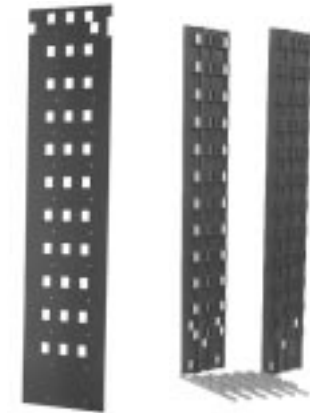

Standard Flat Barrier

Labyrinth Barrier Kit

Table 27. Vertical Bus Barrier Kit

Description	Style Number
Standard flat barrier kit includes one flat barrier, 12 covers and clips.	4719A91G13
Labyrinth barrier kit includes front and rear barrier, bus supports and hardware (does not include shutters).	4719A91G14

Vertical Bus Insulation Kit ❸

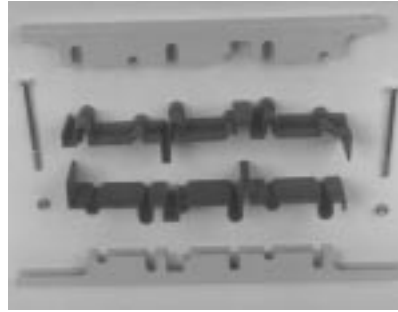

Vertical Bus Insulation Kit

Table 28. Vertical Bus Insulation Kit

Description	Style Number
Kit includes 2 insulators, 2 mounting brackets and mounting hardware.	4719A91G12

Sheet Metal Covers with Mounting Hardware ❸

Table 29. Sheet Metal Covers with Mounting Hardware

Description	Style Number
Side Sheets	
16-Inches (406.4 mm) Deep, Front Mounted	4719A91G31
21-Inches (533.4 mm) Deep, Front Mounted	4719A91G32
21-Inches (533.4 mm) Deep, Back-to-Back Mounted	4719A91G33
Rear Sheets	
20-Inches (508.0 mm) Wide x 90-Inches (2286.0 mm) High	4719A91G34
24-Inches (609.6 mm) Wide x 90-Inches (2286.0 mm) High	4719A91G35
Top Sheets	
20-Inches (508.0 mm) Wide x 16-Inches (406.4 mm) Front Mounted	4719A91G36
20-Inches (508.0 mm) Wide x 21-Inches (533.4 mm) Front Mounted	4719A91G37
20-Inches (508.0 mm) Wide x 21-Inches (533.4 mm) Back-to-Back Mounted	4719A91G38
24-Inches (609.6 mm) Wide x 16-Inches (406.4 mm) Front Mounted	4719A91G39
24-Inches (609.6 mm) Wide x 21-Inches (533.4 mm) Front Mounted	4719A91G40

Shutter Kit ❷

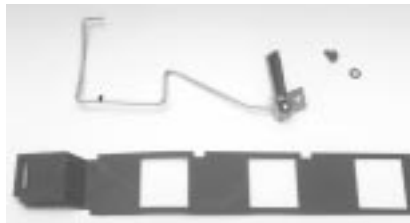

Shutter Kit

Table 30. Shutter Kit

Description	Style Number
Kit includes shutter, spring loaded coupler and mounting screws.	4719A91G15

Blank Unit Door with Mounting Hardware ❶

Table 31. Blank Unit Door with Mounting Hardware

Description	Style Number
6-Inches (152.4 mm) High x 15-1/2 Inches (393.7 mm) Wide	4719A91G20
12-Inches (304.8 mm) High x 15-1/2 Inches (393.7 mm) Wide	4719A91G21
18-Inches (457.2 mm) High x 15-1/2 Inches (393.7 mm) Wide	4719A91G22
24-Inches (609.6 mm) High x 15-1/2 Inches (393.7 mm) Wide	4719A91G23
30-Inches (762.0 mm) High x 15-1/2 Inches (393.7 mm) Wide	4719A91G24
36-Inches (914.4 mm) High x 15-1/2 Inches (393.7 mm) Wide	4719A91G25

Touch-up Paint Kit ❸

Table 32. Touch-up Paint Kit

Description	Style Number
Kit includes three spray cans of ANSI-61 Gray.	4719A91G10

Series 2100/5 Star Structure Parts

Horizontal Bus Bar

65,000 ampere rms bus bracing.

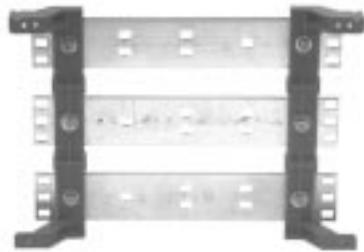

Horizontal Bus Bar

Table 33. Horizontal Bus Bar — Tin-Plated Copper

Structures Number	Width Inches (mm)	Bar Size Inches (mm)	Bars/ Phase	Ampere Rating		Style Number
				UL (50°C)	NEMA (65°C)	
1	20 (508.0)	1/4 x 2 (6.4 x 50.8)	1	600	600	4719A97G28 4719A97G29 4719A97G30
2	40 (1016.0)					
3	60 (1524.0)					
1	20 (508.0)	1/4 x 2 (6.4 x 50.8)	1	—	800	4719A97G31 4719A97G32 4719A97G33
2	40 (1016.0)					
3	60 (1524.0)					
1	20 (508.0)	1/4 x 3 (6.4 x 76.2)	1	—	1000	4719A97G34 4719A97G35 4719A97G36
2	40 (1016.0)					
3	60 (1524.0)					
1	20 (508.0)	1/4 x 3 (6.4 x 76.2)	2	—	1200	4719A97G37 4719A97G38 4719A97G39
2	40 (1016.0)					
3	60 (1524.0)					
1	20 (508.0)	1/4 x 3 (6.4 x 76.2)	1	800	—	4719A97G40 4719A97G41 4719A97G42
2	40 (1016.0)					
3	60 (1524.0)					
1	20 (508.0)	1/4 x 2-1/2 (6.4 x 63.5)	2	1200	—	4719A97G43 4719A97G44 4719A97G45
2	40 (1016.0)					
3	60 (1524.0)					

Horizontal Wireway Door Kit



Horizontal Wireway Door Kit

Table 34. Horizontal Wireway Door Kit

Description Inches (mm)	Style Number
9 (228.6) High x 15-1/2 (393.7) Wide (Standard Kit of 2)	4719A91G18
(1) 15 (381.0) High x 15-1/2 (393.7) Wide, (1) 3 (76.2) High	4719A91G19

Horizontal Bus Barrier Kit



Horizontal Bus Barrier Kit

Table 35. Horizontal Bus Barrier Kit

Description Inches (mm)	Style Number
9 (228.6) High, Front Mounted	4719A91G02
15 (381.0) High, Front Mounted	4719A91G03
15 (381.0) High, Rear Mounted	4719A91G04

Kit includes divider pan, horizontal and vertical barriers, junction piece, and mounting hardware.

Divider Pan/Guide Rails with Mounting Hardware



Divider Pan/Guide Rails with Mounting Hardware

Table 36. Divider Pan/Guide Rails with Mounting Hardware

Description	Style Number
Divider pan/guide rails with mounting hardware.	4719A91G05

Vertical Wireway Door Kit



Vertical Wireway Door Kit

Table 37. Vertical Wireway Door Kit

Description Inches (mm)	Style Number
Kit includes 4 x 45 (101.6 x 1143.0) door, hinges, hinge pins and mounting hardware.	4719A91G17

**Series 2100/5 Star
Structure Parts**

**Horizontal to Vertical Bus
Connection Kit**



Horizontal to Vertical Bus Connection Kit

Table 38. Horizontal to Vertical Bus Connection Kit

Description	Horizontal Bus		Vertical Bus		Style Number
	Ampere Rating	Bars/Phase	Ampere Rating	Material	
Kit includes bus spacers with mounting hardware.	600	1	300	Cu	4719A97G64
			600	Cu	4719A97G65
	800	2	300	Cu	4719A97G72
			600	Cu	4719A97G73
			800	Cu	4719A97G74
	1200	3	300	Cu	4719A97G80
			600	Cu	4719A97G81
			800	Cu	4719A97G82
			1200	Cu	4719A97G84

Horizontal Bus Splice Kit



Horizontal Bus Splice Kit

Table 39. Horizontal Bus Splice Kit — Tin-Plated Copper

Description	Bus Ampere Rating		Bus Size Inches (mm)	Bars/Phase	Style Number
	UL (50°C)	NEMA (65°C)			
Kit includes bus splice plates with mounting hardware.	600	600	2 (50.8)	1	4719A97G86
	—	800	2 (50.8)	1	4719A97G87
	800	—	3 (76.2)	1	4719A97G88
	—	1000	3 (76.2)	1	4719A97G89
	1000	1200	3 (76.2)	2	4719A97G90
	1200	—	2-1/2 (63.5)	2	4719A97G91

Horizontal Bus Insulator Kit

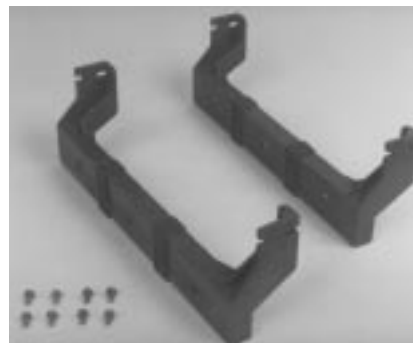

Horizontal Bus Insulator Kit

Table 40. Horizontal Bus Insulator Kit

Description	Style Number
Kit includes 2 insulators with mounting hardware.	4719A91G11

Door Mounting Hardware Kit



Door Mounting Hardware Kit

Table 41. Door Mounting Hardware Kit

Description	Style Number
Kit includes 2 hinges, hinge pins and (2) 1/4 turn latches.	4719A91G26

Series 2100/5 Star Unit Parts

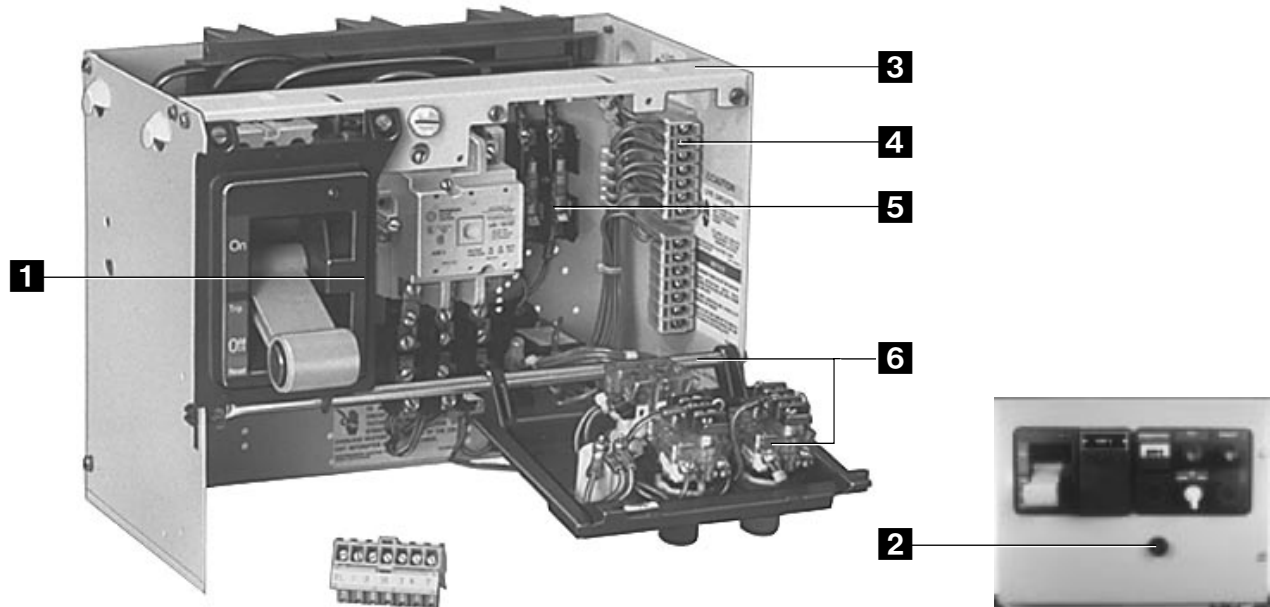

Table 42. Unit Parts

Reference	Description	Page
1	Operating Handle Mechanism	23
2	Overload Reset Button and Reset Rod Extension Kit	23
3	Unit Drawout Top Rail	24
4	Terminal Blocks	24

Reference	Description	Page
5	Control Transformers Primary/Secondary Fuse Holder Kit	24 24
6	Device Panel/Pivot Tube Fusible Disconnect Block Kit	24 24

Operating Handle Mechanism Kit 1

Kit includes operating arm, adjustable linkage, and mounting hardware.



Operating Handle Mechanism Kit

Table 43. Operating Handle Mechanism Kit

Description	Style Number
Circuit Breaker Units	
FB/MCP	4719A92G43
KB	4719A92G05
HFD/HMCP	4719A88G01
HMCPE	4700A99G69
HLD	4700A99G65
HJD/HKD	4719A89G01
LB	4719A92G06
MA/MC	4719A92G07
NB	4719A92G08
FCL	4719A92G44
LCL	4719A92G45
HFD/HMCP (6-Inch Unit)	4719A92G56
Fusible Switch Units	
30/60/100A DS Switch	4719A92G09
200/400A DS Switch	4719A92G10

Overload Reset Button and Reset Rod Extension Kit 2



Overload Reset Button and Reset Rod Extension Kit

Table 44. Overload Reset Button and Reset Rod Extension Kit

Description	Style Number
For A200 starters, the kit includes reset button, extension rod and "O" ring.	4719A92G04

Series 2100/5 Star Unit Parts

Unit Drawout Top Rail



Unit Drawout Top Rail

Table 45. Unit Drawout Top Rail

Description	Style Number
Unit Top Rail with Hardware	4719A92G02

Primary/Secondary Fuse Holder Kit

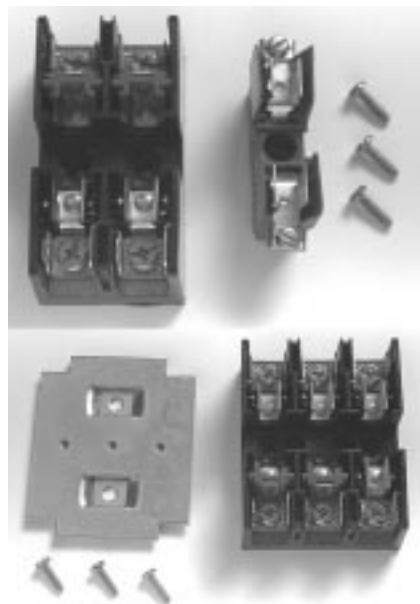

Primary/Secondary Fuse Holder Kit

Table 46. Primary/Secondary Fuse Holder Kit

Description	Style Number
5 Star kit includes fuse block, mounting bracket and screws.	4719A92G01
Series 2100 kit includes fuse block, mounting bracket and screws.	4719A92G59

Terminal Blocks



Terminal Blocks

Table 47. Terminal Blocks

Description	Style Number
White, 7 Circuit, Pull-apart	4719A92G57

Device Panel/Pivot Tube with Mounting Hardware



Device Panel/Pivot Tube with Mounting Hardware

Table 48. Device Panel/Pivot Tube with Mounting Hardware

Description	Style Number
Device panel/pivot tube with mounting hardware.	4719A92G03

Control Transformers (480/240V to 120V Single-Phase)

Table 49. Control Transformers (480/240V to 120V Single-Phase)

Description	Style Number
50 VA	4719A92G46
100 VA	4719A92G48
150 VA	4719A92G49
200 VA	4719A92G50
250 VA	4719A92G51
300 VA	4719A92G52
350 VA	4719A92G53
500 VA	4719A92G54

Fusible Disconnect Block Kit

For use with DS type switch.



Fusible Disconnect Block Kit

Kit includes line and load blocks with clips.

Table 50. Fusible Disconnect Block Kit ^{①②}

Description	Style Number
30A Non-rejection	4719A92G33
30A Rejection	4719A92G34
60A Non-rejection	4719A92G35
60A Rejection	4719A92G36
100A Non-rejection	4719A92G37
100A Rejection	4719A92G38
200A Non-rejection	4719A92G39
200A Rejection	4719A92G40
400A Non-rejection	4719A92G41
400A Rejection	4719A92G42

① Certain fusible designs have line fuse clips mounted on the DS Switch. Non-rejection clips can be removed from the mounting block and mounted on the switch. Rejection clips are non-removable. Order a complete switch assembly.
② For MCCs built after October 1984, consult factory for specific details.

Series C® Retrofit Kits

Series C Retrofit Kits are to be used to upgrade existing Type W and 5 Star Motor Control Center buckets by changing out the old breakers with the Series C. These kits can be applied to both starter and feeder units.

The old breakers that these kits will upgrade include, but are not limited to, the MCP, F, FA, FB, HFB, K, KA, KB, HKB, L, LA, LB and HLB breakers.

5 Star Series C Retrofit Kit



5 Star Series C Retrofit Kit

The 5 Star Series C Retrofit Kit includes:

- Series C device, 65 kA (either HMCP or thermal-magnetic breaker).
- Operating handle mechanism, including tripped indication and push-to-trip.
- Label stating that the MCC unit has been retrofitted with Series C device suitable for 65 kA (similar to UL quality label).
- Templates for desired frame size.
- Assembly instructions.

Type W Series C Retrofit Kit

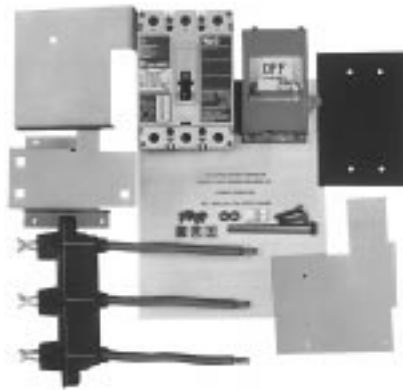

Type W Series C Retrofit Kit

The Type W Series C Retrofit Kit includes:

- Series C device, 65 kA (either HMCP or thermal-magnetic breaker).
- Operating handle mechanism, including tripped indication and push-to-trip.
- Label stating that the MCC unit has been retrofitted with Series C device suitable for 65 kA (similar to UL quality label).
- Templates for proper hole placement for desired frame size.
- Series C breaker mounting hardware.
- New door and hardware.
- New stab assembly.
- Assembly instructions.

F10 Series C Retrofit Kit



F10 Series C Retrofit Kit

The F10 Series C Retrofit Kit includes:

- Series C device, 65 kA (either HMCP or thermal-magnetic breaker).
- Operating handle mechanism, including tripped indication push-to-trip.
- Label stating that the MCC unit has been retrofitted with Series C device suitable for 65 kA (similar to UL quality label).
- Templates for desired frame size.
- Assembly instructions.

How to Order

1. Select the correct Series C device from the table in the applicable RPD
5 Star — RP04304003E
Type W — RP04304006E
F10 — RP04304005E
2. Create a catalog number based on the MCC Type, Device Selected, Modification, Door Size and Device Panel.

Select price from PL04304002E.

Table 51. Series C Retrofits, Catalog Numbering System

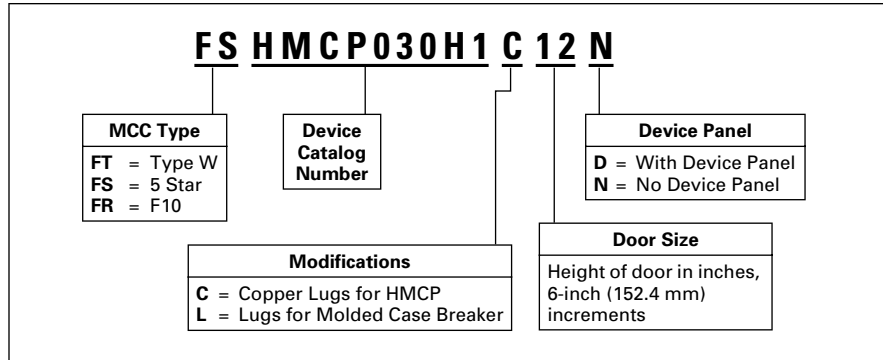

Table 52. Series 2100/5-Star Series C Breaker Retrofit Upgrade Kit

Catalog Number	Catalog Number	Catalog Number	Catalog Number	Catalog Number
FSHMCP003A0	FSHMCP250D5	FSHMCP400X5	FSFDC3020	FSHJD3250
FSHMCP007C0	FSHMCP250F5	FSHFD3015	FSFDC3025	FSJDC3175
FSHMCP015E0	FSHMCP250G5	FSHFD3020	FSFDC3030	FSJDC3200
FSHMCP025D0	FSHMCP250J5	FSHFD3025	FSFDC3040	FSJDC3225
FSHMCP030H1	FSHMCP250K5	FSHFD3030	FSFDC3050	FSJDC3250
FSHMCP050G2	FSHMCP250L5	FSHFD3040	FSFDC3060	FSHKD3300
FSHMCP050K2	FSHMCP250W5	FSHFD3050	FSFDC3070	FSHKD3350
FSHMCP070J2	FSHMCP400D5	FSHFD3060	FSFDC3080	FSHKD3400
FSHMCP070M2	FSHMCP400F5	FSHFD3070	FSFDC3090	FSKDC3300
FSHMCP100L3	FSHMCP400G5	FSHFD3080	FSFDC3100	FSKDC3350
FSHMCP100R3	FSHMCP400J5	FSHFD3090	FSFDC3125	FSKDC3400
FSHMCP150T4	FSHMCP400K5	FSHFD3100	FSFDC3150	—
FSHMCP150U4	FSHMCP400L5	FSHFD3125	FSHJD3175	—
FSHMCP250A5	FSHMCP400W5	FSHFD3150	FSHJD3200	—
FSHMCP250C5	FSHMCP400R5	FSFDC3015	FSHJD3225	—

Note: Entire catalog number is not listed above and will not affect price.

How to Create a Catalog Number

After selecting the circuit device required, create a **Dual Mounted** feeder unit catalog number based on the following:

Note: Catalog number varies in length based on single or dual mounted unit.

Table 53. Catalog Numbering System Example

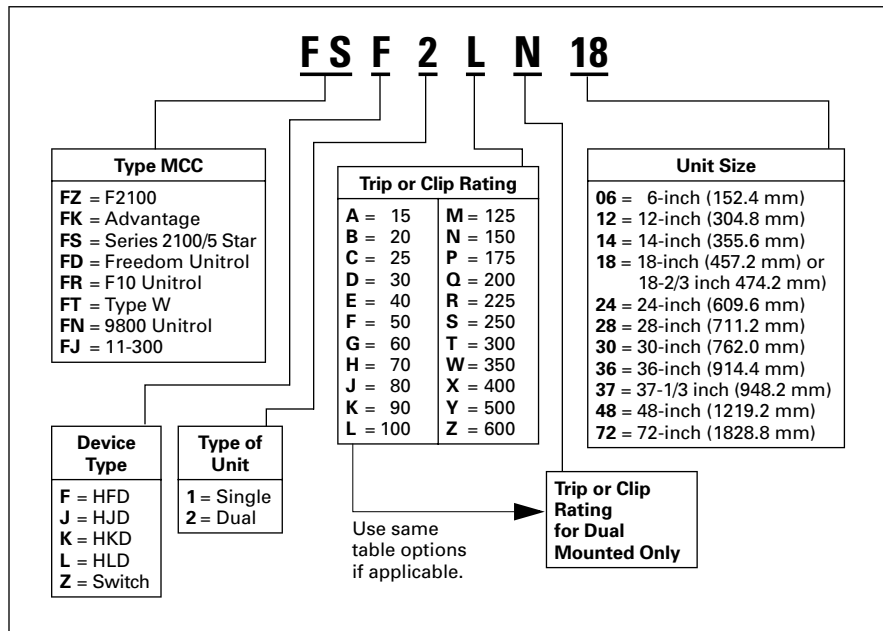

Replacement Feeder Units

Product Description

Each Feeder Unit consists of a single mounted 3-pole molded case circuit breaker or fusible switch (dual mounted are also available). Each unit includes a new wrapper, stab assembly, door, handle mechanism and customer specific disconnect device. They are shipped assembled and ready to install into the existing motor control center.

The following are simple steps to select and order a new feeder unit:

Step 1

Select the circuit device required from **Table 54** below.

Step 2

Verify the amount of space available.

Step 3

Create a catalog number from the formula on **Table 53** on **Page 26**.

Unit options and modifications for replacement feeder units:

For factory installed molded case circuit breaker modifications or additional unit options, contact the factory for prices and availability.

Table 54. Electrical Characteristics and Space Requirements of Molded Case Circuit Breakers and Fusible Switch Replacement Feeder Units — Inches (mm)

Device Type	Maximum Amperes	Interrupting Rating (kAIC)			Trip Rating or Clip	Freedom 2100 Series 2100/5 Star Advantage		Freedom Unitrol		F10		Type W		9800		11-300				
		240V	480V	600V		Single	Dual	Single	Dual ^①	Single	Dual ^①	Single	Dual	Single	Dual ^①	Single	Dual			
HFD	150	100	65	25	15															
					20															
					25															
					30															
					40															
					50															
					60															
70																				
					80	6 ^② (152.4)		6 ^② (152.4)												
					90	12 ^③ (304.8)	12 (304.8)	12 ^③ (304.8)	12 (304.8)	12 ^③ (304.8)	12 (304.8)	12 ^③ (304.8)	12 (304.8)	14 (355.6)	14 (355.6)	14 (355.6)	14 (355.6)			
					100															
					125	12 (304.8)	12 (304.8)	12 (304.8)	18 (457.2)	12 (304.8)	18 (457.2)	12 (304.8)	12 (304.8)	14 (355.6)	18 (457.2)	14 (355.6)	14 (355.6)			
					150	12 ^③ (304.8)						12 ^③ (304.8)								
HJD	250	100	65	25	175															
					200															
					225	18 (457.2)		24 (609.6)		18 (457.2)		18 (457.2)		18 (457.2)		14 (355.6)				
				250																
HKD	400	100	65	35	300															
					350															
					400	24 (609.6)		24 ^④ (609.6)		24 ^④ (609.6)		24 (609.6)		28 ^④ (711.2)		14 (355.6)				
HLD	600	100	65	35	500															
					600	24 (609.6)		24 ^④ (609.6)		24 ^④ (609.6)										
Fusible Switch	30	100	100	100	30	12 (304.8)	12 ^③ (304.8)	12 (304.8)	18 (457.2)	12 (304.8)	18 (457.2)	12 (304.8)	12 ^③ (304.8)	14 (355.6)	18 (457.2)	14 (355.6)	14 (355.6)			
	60	100	100	100	60	12 (304.8)	12 ^③ (304.8)	12 (304.8)	18 (457.2)	18 (457.2)	18 (457.2)	12 (304.8)	12 ^③ (304.8)	14 (355.6)	18 (457.2)	14 (355.6)	14 (355.6)			
	100	100	100	100	100	18 (457.2)		18 (457.2)		18 (457.2)		12 ^③ (304.8)		18 (457.2)		18 (457.2)	18-2/3 (474.2)			
	200	100	100	100	200	36 (914.4)		30 (762.0)		30 (762.0)		24 (609.6)		28 (711.2)		28 (711.2)				
	400	100	100	100	400	36 (914.4)		72 ^④ (1828.8)		48 ^④ (1219.2)		42 (1066.8)		42 ^④ (1066.8)		42 (1066.8)				
	600	100	100	100	600	48 (1219.2)		72 ^④ (1828.8)												

① Combined ampacity no greater than 150A for 12-inch (304.8 mm) height. For greater than 150A, 18-inch (457.2 mm) required.

② 100A maximum.

③ Available in 18-inch (457.2 mm) height.

④ Cable in/cable out, no stab assembly.

NEMA is the registered trademark and service mark of the National Electrical Manufacturers Association. UL is a registered trademark of Underwriters Laboratories Inc.

Eaton Corporation
Cutler-Hammer business unit
1000 Cherrington Parkway
Moon Township, PA 15108-4312
USA
tel: 1-800-525-2000
www.cutler-hammer.eaton.com



Cutler-Hammer

Motor Control Center Type Series 2100/5 Star

Renewal Parts

Supersedes RPD Supplement 8991c
pages 1-28, dated May 1998

Description

Page

Motor Control Center Type Series 2100/5 Star

Distributor Ordering Instructions	2
Procedure for Identifying MCC Renewal Units and Parts	2
Identifying Motor Control Center Types	3
Identification by Original Handle Mechanism	3
Procedure for Identifying Motor Control Center Types	4
Series 2100/5 Star Product Description	5
Replacement Starter Units	6 – 15
Unit Options	16 – 18
Structure Parts	19 – 22
Unit Parts	23 – 24
Series C Retrofit Kits	25
Replacement Feeder Units (All Vintages)	27

MCC Type	Dates	Cutler-Hammer Renewal Parts Publication
F2100 Advantage™ Series 2100	1995 – 1992 – 1987 – 95	RP04304001E RP04304002E RP04304003E
5 Star Freedom Unitrol F10 Unitrol	1975 – 87 1988 – 94 1972 – 89	RP04304003E RP04304004E RP04304005E
Type W 9800 Unitrol 11-300	1965 – 75 1956 – 74 1935 – 65	RP04304006E RP04304007E RP04304008E

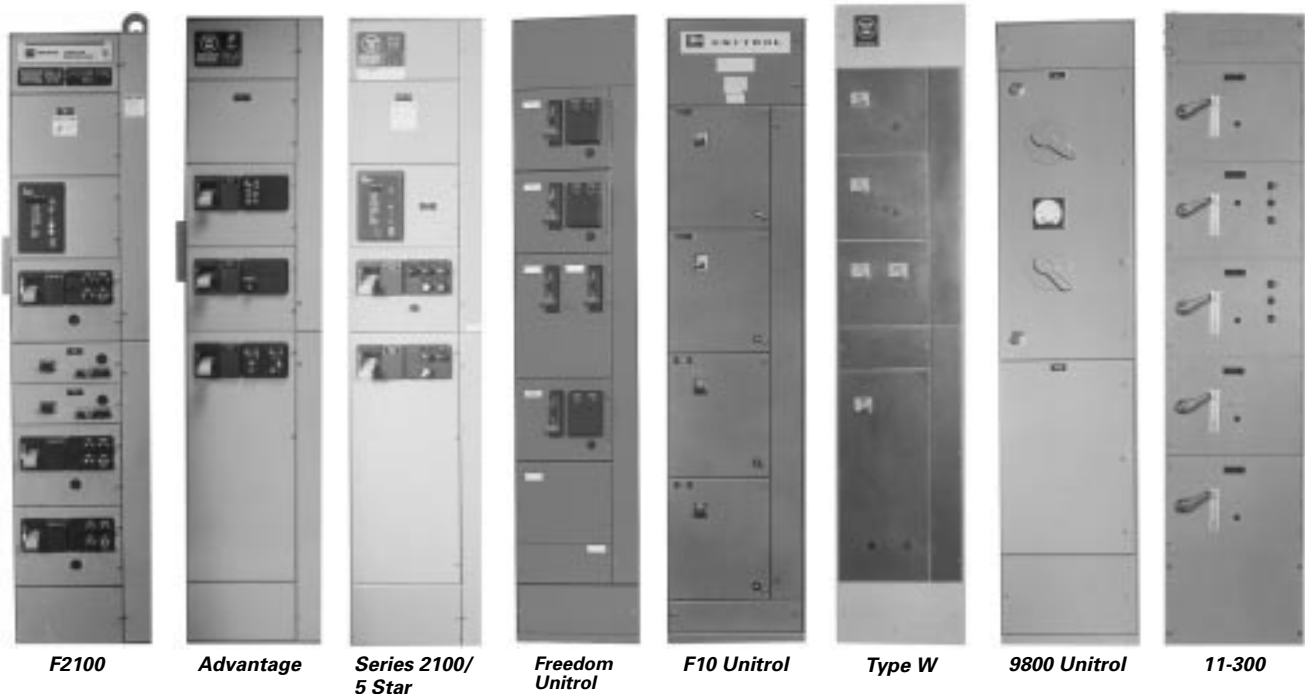

F2100

Advantage

Series 2100/
5 Star

Freedom
Unitrol

F10 Unitrol

Type W

9800 Unitrol

11-300

Identifying Motor Control Center Types

In most cases, it is possible to identify MCC design by handle type. Starter type, bucket width and door width can assist in identification.

Table 1. Identifying Motor Control Center Types

MCC Type	Type of Handle Mechanism	Original MCC Starter Type	Bucket Width Inches (mm)	Door Width Inches (mm)	Original Manufacturer ①	Starter Type (Installed in New Unit)
F2100 ②	Lever	Freedom Series	13-3/4 (349.3)	15-5/8 (397.0)	Cutler-Hammer 1994 to Present	Freedom
Advantage ②	Lever	Advantage	13-3/4 (349.3)	15-5/8 (397.0)	Westinghouse until 1994 Cutler-Hammer 1994 to Present	Advantage
Series 2100 ②	Lever	A200	13-3/4 (349.3)	15-5/8 (397.0)	Westinghouse until 1994 Cutler-Hammer 1994 to Present	A200
5 Star ②	Lever	A200	13-3/4 (349.3)	15-5/8 (397.0)	Westinghouse 1975 – 1987	A200
Freedom Unitrol	Slider	Freedom Series	13-7/8 (352.5)	15-1/2 (393.7)	Cutler-Hammer 1988 – 1994	Freedom
F10 Unitrol	Slider and Lever	Citation	14 (355.6)	14-3/4 (374.7) w/ Wireway 19-1/2 (495.3) w/o Wireway	Cutler-Hammer 1972 – 1989	Freedom
Type W	Slider	A200 or 11-200	11-3/4 (298.5)	13-3/8 (339.9)	Westinghouse 1965 – 1975	A200
9800 Unitrol	Rotary ③	3 Star/Citation	16-1/8 (409.7)	19-3/8 (492.3)	Cutler-Hammer 1956 – 1974	Freedom
11-300	Rotary	11-200 Lifeline Type N/A200	15-3/4 (400.1)	20 (508.0)	Westinghouse 1950 – 1965	A200

① MCC types were sometimes produced outside the time spans shown. This was due to the overlap of production when a new design was adopted.

② The unit “wrappers” are mechanically identical for these designs.

③ 9800 originally was supplied with Rotary. New replacement units are manufactured with slider handle mechanism.

Identification by Original Handle Mechanism



*F2100, Advantage,
Series 2100/5 Star*



Freedom Unitrol



*F10 Unitrol Slider
9800 Unitrol*



*F10 Unitrol Lever
and 9800 Unitrol*



Type W

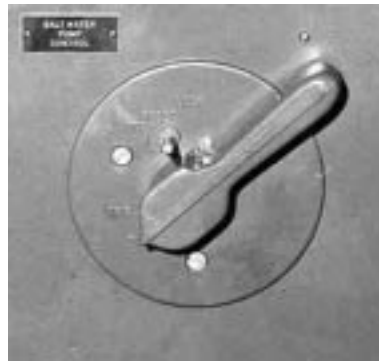

9800 Unitrol

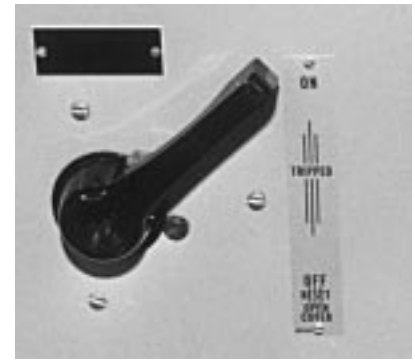

11-300

Procedure for Identifying Motor Control Center Types

In the event that the nameplate is missing, it is possible to identify the MCC design by the type of handle mechanism, starter type, bucket width and door width.

Table 2. Identifying Motor Control Center Types

MCC Type	Type of Handle Mechanism	Starter Type	Bucket Width Inches (mm)	Door Width Inches (mm)	Cutler-Hammer Renewal Parts Publication
F2100 Advantage Series 2100	Lever Lever Lever	Freedom Series Advantage A200	13-3/4 (349.3) 13-3/4 (349.3) 13-3/4 (349.3)	15-5/8 (397.0) 15-5/8 (397.0) 15-5/8 (397.0)	RP04304001E RP04304002E RP04304003E
5 Star Freedom Unitrol F10 Unitrol	Lever Slider Lever/Slider	A200 Freedom Series Citation	13-3/4 (349.3) 13-7/8 (352.5) 14 (355.6)	15-5/8 (397.0) 15-1/2 (393.7) 14-3/4 (374.7) w/ Wireway or 19-1/2 (495.3) w/o Wireway	RP04304003E RP04304004E RP04304005E
Type W 9800 Unitrol 11-300	Slider Rotary Rotary	A200 or 11-200 3 Star and/or Citation 11-200 Lifeline N and/or A200	11-3/4 (298.5) 16-1/8 (409.7) 15-3/4 (400.1)	13-3/8 (339.9) 19-3/8 (492.3) 20 (508.0)	RP04304006E RP04304007E RP04304008E



F2100

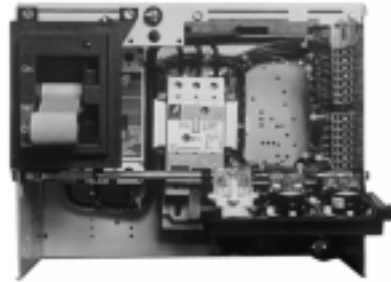

Advantage



Series 2100/5 Star

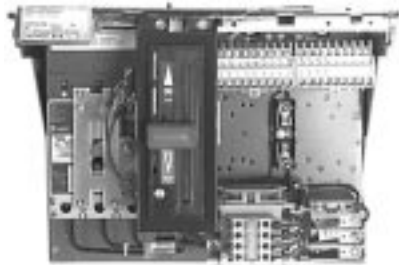

Freedom Unitrol

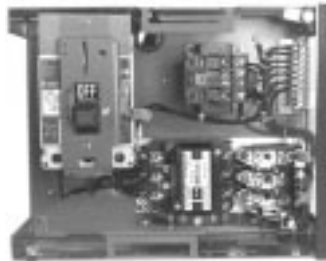

F10 Unitrol



Type W



9800 Unitrol



11-300

**Series 2100/5 Star
Product Description**

Introduced in 1975, the Westinghouse 5 Star MCC was the basis for the Series 2100 and Advantage designs. The vertical structures are normally 20 inches (508.0 mm) wide, 90 inches (2286.0 mm) high and 16 inches (406.4) or 21 inches (533.4 mm) deep. Vertical sections may be bolted together forming a single lineup with continuous horizontal bus and open horizontal wireways. Unit height is measured in 6 inch (152.4 mm) increments, up to a maximum of 72 inches (1828.8 mm) of usable vertical space.

A two-tone light/dark enamel paint system is used for this design. Ferro white is applied to the structural framework and units. ANSI 61 gray is applied to the roof and side sheets and all exterior doors. Starter units are 13-3/4 inches (349.3 mm) wide.

The Series 2100/5 Star starter unit's handle mechanism is a gray toggle type handle with a black exterior mounting panel and is used on the Advantage and Freedom 2100 designs. Bus and bus support systems are typically braced to withstand fault currents of 42,000A on the 5 Star and 65,000A on the Series 2100.

Table 3. 2100 Product Rating

Maximum Ratings
3-Phase, 600V, 600 hp, 3200A Bus



**Series F2100
Structure**

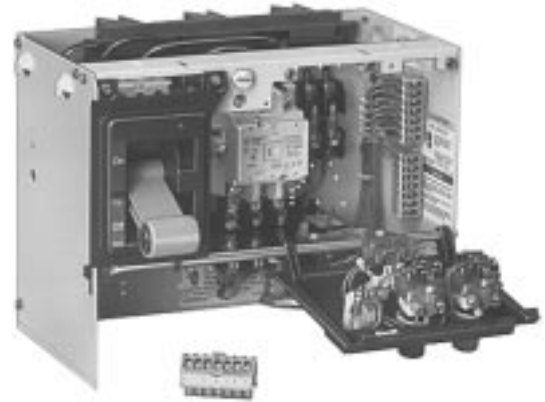

Series F2100 Starter Unit

Series 2100/5 Star Replacement Starter Units

How to Order

When ordering a replacement unit, you receive:

- Series C® HMCP.
- A200 Starter.
- Unit options as specified.
- New steel wrapper, door and handle mechanism.
- New stabs.
- UL® label.

Use the following steps for creating a catalog number for your specific application:

Step 1

Select the correct replacement unit from **Pages 6 – 27**. When selecting, you need to know the following:

- MCC type.
- Class of Unit (FVNR, FVR, Reduced Voltage — Autotransformer or Part Winding or Solid State, FV – 2 Speed, 1 Winding or 2 Speed, 2 Winding, etc.).
- Starter size or horsepower rating.
- Protection device (breaker or fusible).
- Service voltage.
- Control voltage.
- Space required.

Step 2

Verify required space is available.

Step 3

Create a catalog number by selecting Catalog Codes from the columns per the example given.

Step 4

Add modifications as required from the Unit Options on **Pages 16 – 18**. Space available determines allowable options.

Table 4. Catalog Numbering System Example

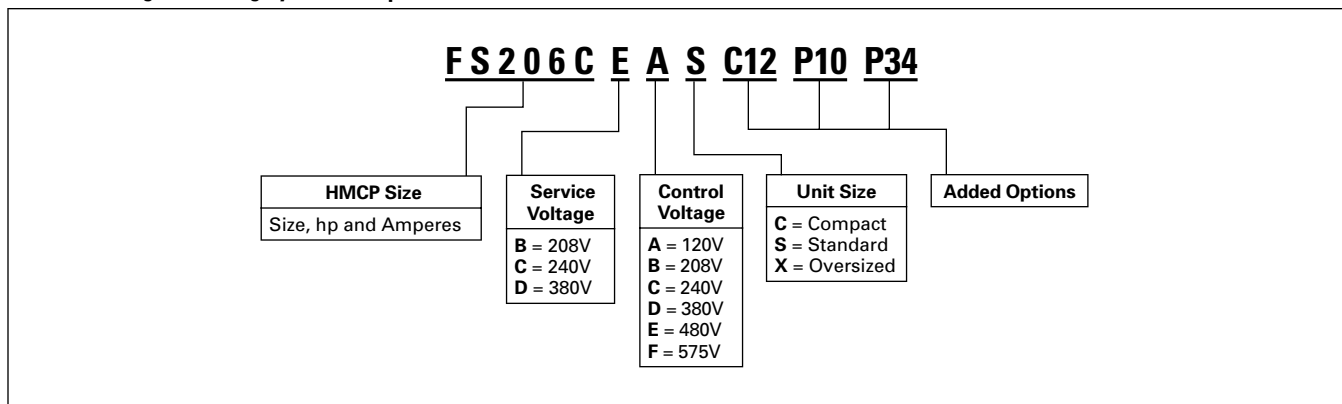

Table 5. Full Voltage Non-Reversing Combination Starter — HMCP (Must specify if HMCPE is required)

NEMA® Size	Maximum Horsepower					HMCP Size	Catalog Code	Service Voltage	Catalog Code	Control Voltage	Catalog Code	Space Options Inches (mm)	Catalog Code
	208V	240V	380V	480V	600V								
1	0.5	0.33	1	1	1.5	3	FS206A FS206B FS206C FS206D	208	B C D E F	120	A B C D E F	12 (304.8) High 18 (457.2) High	S X
	1	1	2	3	3	7		240		208			
	3	3	5	7.5	7.5	15		380		240			
	7.5	7.5	10	10	10	30		480		380			
								575		480			
2	10	15	25	25	25	50	FS206E	208	B C D E F	120	A B C D E F	12 (304.8) High 18 (457.2) High	S X
								240		208			
								380		240			
								480		380			
								575		480			
3	25	30	50	50	50	100	FS206H	208	B C D E F	120	A B C D E F	18 (457.2) High 24 (609.6) High	S X
								240		208			
								380		240			
								480		380			
								575		480			
4	40	50	75	100	100	150	FS206L	208	B C D E F	120	A B C D E F	18 (457.2) High 24 (609.6) High	S X
								240		208			
								380		240			
								480		380			
								575		480			
5	60	60	125	150	150	250	FS206P FS206R	208	B C D E F	120	A B C D E F	36 (914.4) High	S
	75	100	150	200	200	400		240		208			
								380		240			
								480		380			
								575		480			

Series 2100/5 Star Replacement Starter Units

Table 6. Full Voltage Reversing Combination Starter — HMCP

NEMA Size	Maximum Horsepower					HMCP Size	Catalog Code	Service Voltage	Catalog Code	Control Voltage	Catalog Code	Space Options Inches (mm)	Catalog Code
	208V	240V	380V	480V	600V								
1	0.5	0.33	1	1	1.5	3	FS216A FS216B FS216C FS216D	208	B C D E F	120	A B C D E F	18 (457.2) High 24 (609.6) High	S X
	1	1	2	3	3	7		240		208			
	3	3	5	7.5	7.5	15		380		240			
	7.5	7.5	10	10	10	30		480		380			
								575		480			
575	575						575						
2	10	15	25	25	25	50	FS216E	208	B C D E F	120	A B C D E F	18 (457.2) High 24 (609.6) High	S X
								240		208			
								380		240			
								480		380			
								575		480			
3	25	30	50	50	50	100	FS216H	208	B C D E F	120	A B C D E F	24 (609.6) High	S
								240		208			
								380		240			
								480		380			
								575		480			
4	40	50	75	100	100	150	FS216L	208	B C D E F	120	A B C D E F	24 (609.6) High	S
								240		208			
								380		240			
								480		380			
								575		480			
5	50	60	100	125	150	250	FS216P FS216R	208	B C D E F	120	A B C D E F	54 (1371.6) High	S
	75	100	150	200	200	400		240		208			
								380		240			
								480		380			
								575		480			

Table 7. Full Voltage 2 Speed 1 Winding — Constant/Variable Torque — HMCP ①

NEMA Size	Maximum Horsepower					HMCP Size	Catalog Code	Service Voltage	Catalog Code	Control Voltage	Catalog Code	Space Options Inches (mm)	Catalog Code
	208V	240V	380V	480V	600V								
1	0.5	0.33	1	1	1.5	3	FS946A FS946B FS946C FS946D	208	B C D E F	120	A B C D E F	18 (457.2) High 24 (609.6) High	S X
	1	1	2	3	3	7		240		208			
	3	3	5	7.5	7.5	15		380		240			
	7.5	7.5	10	10	10	30		480		380			
								575		480			
575	575						575						
2	10	15	25	25	25	50	FS946E	208	B C D E F	120	A B C D E F	18 (457.2) High 24 (609.6) High	S X
								240		208			
								380		240			
								480		380			
								575		480			
3	25	30	50	50	50	100	FS946H	208	B C D E F	120	A B C D E F	42 (1066.8) High	S
								240		208			
								380		240			
								480		380			
								575		480			
4	40	50	75	100	100	150	FS946L	208	B C D E F	120	A B C D E F	42 (1066.8) High	S
								240		208			
								380		240			
								480		380			
								575		480			
5	60	60	125	150	150	250	FS946P FS946R	208	B C D E F	120	A B C D E F	42 (1066.8) High	S
	75	100	150	200	200	400		240		208			
								380		240			
								480		380			
								575		480			

① For constant horsepower instead of constant/variable torque, see Option SV6 on Page 18.

Series 2100/5 Star Replacement Starter Units

Table 8. Full Voltage 2 Speed 2 Winding — Constant/Variable Torque — HMCP ①

NEMA Size	Maximum Horsepower					HMCP Size	Catalog Code	Service Voltage	Catalog Code	Control Voltage	Catalog Code	Space Options Inches (mm)	Catalog Code
	208V	240V	380V	480V	600V								
1	0.5	0.33	1	1	1.5	3	FS956A	208	B	120	A	18 (457.2) High 24 (609.6) High	S
	1	1	2	3	3	7	FS956B	240	C	208	B		X
	3	3	5	7.5	7.5	15	FS956C	380	D	240	C		
	7.5	7.5	10	10	10	30	FS956D	480	E	380	380		D
2	10	15	25	25	25	50	FS956E	208	B	120	A	18 (457.2) High 24 (609.6) High	S
	10	15	25	25	25	50	FS956E	240	C	208	B		X
								380	D	240	C		
								480	E	380	D		
								575	F	480	E		575
3	25	30	50	50	50	100	FS956H	208	B	120	A	30 (762.0) High	S
	25	30	50	50	50	100	FS956H	240	C	208	B		
								380	D	240	C		
								480	E	380	D		
								575	F	480	E		575
4	40	50	75	100	100	150	FS956L	208	B	120	A	30 (762.0) High	S
	40	50	75	100	100	150	FS956L	240	C	208	B		
								380	D	240	C		
								480	E	380	D		
								575	F	480	E		575
5	50	60	100	125	150	250	FS956P	208	B	120	A	54 (1371.6) High	S
	75	100	150	200	200	400	FS956R	240	C	208	B		
	50	60	100	125	150	250	400	FS956P	380	D	240		C
									480	E	380		D
									575	F	480		E

① For constant horsepower instead of constant/variable torque, see Option SV6 on Page 18.

Table 9. Reduced Voltage Autotransformer — HMCP

NEMA Size	Maximum Horsepower					HMCP Size	Catalog Code	Service Voltage	Catalog Code	Control Voltage	Catalog Code	Space Options Inches (mm)	Catalog Code
	208V	240V	380V	480V	600V								
2	10	15	25	25	25	50	FS606E	208	B	120	A	36 (914.4) High	S
	10	15	25	25	25	50	FS606E	240	C	208	B		
								380	D	240	C		
								480	E	380	D		
								575	F	480	E		575
3	25	30	50	50	50	100	FS606H	208	B	120	A	54 (1371.6) High	S
	25	30	50	50	50	100	FS606H	240	C	208	A		
								380	D	240	B		
								480	E	380	C		
								575	F	480	D		575
4	40	50	75	100	100	150	FS606L	208	B	120	A	54 (1371.6) High	S ②
	40	50	75	100	100	150	FS606L	240	C	208	A		
								380	D	240	B		
								480	E	380	C		
								575	F	480	D		575
5	50	60	100	125	150	250	FS606P	208	B	120	A	72 (1828.8) High	S ②
	75	100	150	200	200	400	FS606R	240	C	208	B		
	50	60	100	125	150	250	400	FS606P	380	D	240		C
									480	E	380		D
									575	F	480		E

② If existing MCC is back-to-back design, 36 inches (914.4 mm) in bottom rear is unusable.

Series 2100/5 Star Replacement Starter Units

Table 10. Reduced Voltage Part Winding — HMCP

NEMA Size	Maximum Horsepower					HMCP Size	Catalog Code	Service Voltage	Catalog Code	Control Voltage	Catalog Code	Space Options Inches (mm)	Catalog Code
	208V	240V	380V	480V	600V								
1	10	10	15	15	15	30	FS706D	208 240 380 480 575	B C D E F	120 208 240 380 480 575	A B C D E F	18 (457.2) High	S
2	20	25	40	40	40	100	FS706F	208 240 380 480 575	B C D E F	120 208 240 380 480 575	A B C D E F	18 (457.2) High	S
3	40	50	75	75	75	150	FS706J	208 240 380 480 575	B C D E F	120 208 240 380 480 575	A B C D E F	30 (762.0) High	S
4	—	—	—	100	125	150	FS706L	208 240	B C D E F	120 208	A B C D E F	36 (914.4) High	S
	75	75	150	150	150	250	FS706M	240 380 480 575		240 380 480 575		48 (1219.2) High	S
5	100 150	125 150	— 250	250 350	300 250	400 600	FZ706R FZ706T	208 240 380 480 575	B C D E F	120 208 240 380 480 575	A B C D E F	72 (1828.8) High	S

Table 11. Reduced Voltage Wye Delta Open Transition — HMCP

NEMA Size	Maximum Horsepower					HMCP Size	Catalog Code	Service Voltage	Catalog Code	Control Voltage	Catalog Code	Space Options Inches (mm)	Catalog Code
	208V	240V	380V	480V	600V								
2	20	25	40	40	40	100	FS806F	208 240 380 480 575	B C D E F	120 208 240 380 480 575	A B C D E F	30 (762.0) High	S
3	40	50	75	75	75	150	FS806J	208 240 380 480 575	B C D E F	120 208 240 380 480 575	A B C D E F	42 (1066.8) High	S
4	60 —	75 —	125 150	150 —	150 —	250 400	FS806M FS806N	208 240 380 480 575	B C D E F	120 208 240 380 480 575	A B C D E F	54 (1371.6) High	S
5	100 150	125 150	200 250	250 350	300 —	400 600	FS806R FS806T	208 240 380 480 575		B C D E F		120 208 240 380 480 575	A B C D E F

Series 2100/5 Star Replacement Starter Units

Table 12. Reduced Voltage Wye Delta Closed Transition — HMCP (Non-Chiller Application)

NEMA Size	Maximum Horsepower					HMCP Size	Catalog Code	Service Voltage	Catalog Code	Control Voltage	Catalog Code	Space Options Inches (mm)	Catalog Code
	208V	240V	380V	480V	600V								
2	20	25	40	40	40	100	FS896F	208 240 380 480 575	B C D E F	120 208 240 380 480 575	A B C D E F	30 (762.0) High	S
3	40	50	50	50	50	100	FS896J	208 240 380 480 575	B C D E F	120 208 240 380 480 575	A B C D E F	42 (1066.8) High	S
4	60 —	75 —	125 150	150 —	150 —	250 400	FS896M FS896N	208 240 380 480 575	B C D E F	120 208 240 380 480 575	A B C D E F	60 (1524.0) High	S
5	100 150	125 150	200 250	250 300	300 —	400 600	FS896R FS896T	208 240 380 480 575	B C D E F	120 208 240 380 480 575	A B C D E F	72 (1828.8) High	S

IT06 — Intelligent Technologies *IT*. Solid-State Reduced Voltage Starter — HMCP

The *IT*. solid-state reduced voltage starter uses SCRs when starting and a low impedance run circuit during operation. Solid-state starters have (5) 24V dc inputs and 2 relay outputs. Soft start units include a disconnect, starter, 24V dc power supply and 100VA CPT.

Motor Service Factor (SF) Effect on *IT*. Starter Selection

- A 1.0 service factor motor may draw up to 1.00 x full load amperes.
- A 1.15 service factor motor may draw up to 1.15 x full load amperes.
- 15% more current. *IT*. starters are current rated devices. In some cases, a larger *IT*. SSRV starter must be supplied for 1.15 SF motors. See the maximum horsepower chart below.

Note: Most motors used in industrial applications are 1.15 Service Factor (SF).

Table 13. Replacement *IT*. Soft Start Units

Service Factor	Horsepower	<i>IT</i> . Soft-Start Amperes	HMCP Amperes	Catalog Code	Service Voltage	Catalog Code	Control Voltage	Catalog Code	Space Options	Catalog Code
1.15	10	37	100	FS306A	208	B	120	A	12 (304.8) High	S
	15	66	150	FS306B			208	B		
	30	105		FS306C			240	C	18 (457.2) High	
	40	135	400	FS306D			380	D	36 (914.4) High	
	50	180		FS306E			480	E		
	60	240		FS306F			575	F		
	75	304	FS306G	—			—			
1.15	10	37	100	FS306A	240	C	120	A	12 (304.8) High	S
	20	66	150	FS306B			208	B		
	30	105		FS306C			240	C	18 (457.2) High	
	40	135	250	FS306D			380	D	36 (914.4) High	
	60	180		FS306E			480	E		
	75	240		FS306F			575	F		
	100	304	FS306G	—			—			
1.15	15	37	100	FS306A	380	D	120	A	12 (304.8) High	S
	30	66	150	FS306B			208	B		
	45	105		FS306C			240	C	18 (457.2) High	
	55	135	250	FS306D			380	D	36 (914.4) High	
	75	180	400	FS306E			480	E		
	110	240	FS306F	575			F			
	132	304	600	FS306G			—	—		

Series 2100/5 Star Replacement Starter Units

Table 13. Replacement *IT* Soft Start Units (Continued)

Service Factor	Horsepower	<i>IT</i> Soft-Start Amperes	HMCP Amperes	Catalog Code	Service Voltage	Catalog Code	Control Voltage	Catalog Code	Space Options	Catalog Code
1.15	20	37	100	FS306A	480	E	120	A	12 (304.8) High	S
	40	66		FS306B			208	B		
	60	105		FS306C			240	C		
	75	135	FS306D	380			D			
	125	180	400	FS306E			480	E	36 (914.4) High	
	150	240		FS306F			575	F		
	200	304		FS306G			—	—		
—	—	—		—	—					
1.15	30	37	100	FS306A	575	F	120	A	12 (304.8) High	S
	50	66		FS306B			208	B		
	75	105		FS306C			240	C		
	100	135	FS306D	380			D			
	150	180	250	FS306E			480	E	36 (914.4) High	
	200	240		FS306F			575	F		
	250	304	400	FS306G			—	—		
	—	—		—			—	—		

Table 14. Full Voltage Non-Reversing — Fusible ①

NEMA Size	Maximum Horsepower					Fuse Clip Amperes	Catalog Code	Service Voltage	Catalog Code	Control Voltage	Catalog Code	Space Options Inches (mm)	Catalog Code
	208V	240V	380V	480V	600V								
1	7.5	7.5	10	10	10	30	FS204C	208 240 380 480 575	B C D E F	120 208 240 380 480 575	A B C D E F	12 (304.8) High 18 (457.2) High	S X
2	— 10	— 15	15 25	15 25	25 —	30 60	FS204E FS204F	208 240 380 480 575	B C D E F	120 208 240 380 480 575	A B C D E F	12 (304.8) High 18 (457.2) High	S X
3	— 25	20 30	30 50	40 50	50 —	60 100	FS204H FS204J	208 240 380 480 575	B C D E F	120 208 240 380 480 575	A B C D E F	24 (609.6) High	S
4	— 50	— 50	— 50	60 100	75 100	100 200	FS204L FS204M	208 240 380 480 575	B C D E F	120 208 240 380 480 575	A B C D E F	48 (1219.2) High	S
5	60 100	60 100	100 150	150 200	150 200	200 400	FS204P FS204R	208 240 380 480 575	B C D E F	120 208 240 380 480	A B C D E	60 (1524.0) High	S

① Fuse clip ratings shown are based on Class RK1, 5 fuses.

Series 2100/5 Star Replacement Starter Units

Table 15. Full Voltage Reversing — Fusible ①

NEMA Size	Maximum Horsepower					Fuse Clip Amperes	Catalog Code	Service Voltage	Catalog Code	Control Voltage	Catalog Code	Space Options Inches (mm)	Catalog Code			
	208V	240V	380V	480V	600V											
1	7.5	7.5	10	10	10	30	FS214C	208	B	120	A	18 (457.2) High	S			
								240						C	208	B
								380						D	240	C
								480						E	380	D
								575						F	480	E
								575						F	575	F
2	— 10	— 15	15 25	15 25	25 —	30 60	FS214E FS214F	208	B	120	A	18 (457.2) High	S			
								240						C	208	B
								380						D	240	C
								480						E	380	D
								575						F	480	E
								575						F	575	F
3	— 25	20 30	30 50	40 50	50 —	60 100	FS214H FS214J	208	B	120	A	30 (762.0) High	S			
								240						C	208	B
								380						D	240	C
								480						E	380	D
								575						F	480	E
								575						F	575	F
4	— 50	— 50	— 60	60 100	75 100	100 200	FS214L FS214M	208	B	120	A	48 (1219.2) High	S			
								240						C	208	B
								380						D	240	C
								480						E	380	D
								575						F	480	E
								575						F	575	F
5	60 100	60 100	100 150	150 200	150 200	200 400	FS214P FS214R	208	B	120	A	72 (1828.8) High	S			
								240						C	208	B
								380						D	240	C
								480						E	380	D
								575						F	480	E
								575						F	575	F

① Fuse clip ratings shown are based on Class RK1, 5 fuses.

Table 16. Full Voltage Non-Reversing Vacuum Starters — Fusible ②

NEMA Size	Maximum Horsepower					Fuse Clip Amperes	Catalog Code	Service Voltage	Catalog Code	Control Voltage	Catalog Code	Space Options Inches (mm)	Catalog Code			
	208V	240V	380V	480V	600V											
4	— 50	— 50	— 60	60 100	75 100	100 200	FSV04L FSV04M	208	B	120	A	36 (914.4) High	S			
								240						C	208	B
								380						D	240	C
								480						E	380	D
								575						F	480	E
								575						F	575	F
5	60	60	100	150	150	200	FSV04P	208	B	120	A	60 (1524.0) High	S			
								240				C		208	B	
								380				D		240	C	
	100	100	150	200	200	400	FSV04R	480	E	380	D	72 (1828.8) High	S			
								575						F	480	E
								575						F	575	F

② Fuse clip ratings shown are based on Class RK1, 5 fuses.

Series 2100/5 Star Replacement Starter Units

Table 17. Full Voltage 2 Speed 1 Winding — Fusible — Constant/Variable Torque ①②

NEMA Size	Maximum Horsepower					Fuse Clip Amperes	Catalog Code	Service Voltage	Catalog Code	Control Voltage	Catalog Code	Space Options Inches (mm)	Catalog Code
	208V	240V	380V	480V	600V								
1	7.5	7.5	10	10	10	30	FS944C	208 240 380 480 575	B C D E F	120 208 240 380 480 575	A B C D E F	18 (457.2) High 24 (609.6) High	S X
2	— 15	— 15	15 25	15 25	25 —	30 60	FS944E FS944F	208 240 380 480 575	B C D E F	120 208 240 380 480 575	A B C D E F	24 (609.6) High 30 (762.0) High	S X
3	— 25	20 30	30 50	40 50	50 —	60 100	FS944H FS944J	208 240 380 480 575	B C D E F	120 208 240 380 480 575	A B C D E F	42 (1066.8) High	S
4	— 50	— 50	— 60	60 100	75 100	100 200	FS944L FS944M	208 240 380 480 575	B C D E F	120 208 240 380 480 575	A B C D E F	54 (1371.6) High	S

① Fuse clip ratings shown are based on Class RK1, 5 fuses.

② For constant horsepower instead of constant/variable torque, see option SV6 on Page 18.

Table 18. Full Voltage 2 Speed 2 Winding — Fusible – Constant/Variable Torque ③④

NEMA Size	Maximum Horsepower					Fuse Clip Amperes	Catalog Code	Service Voltage	Catalog Code	Control Voltage	Catalog Code	Space Options Inches (mm)	Catalog Code
	208V	240V	380V	480V	600V								
1	7.5	7.5	10	10	10	30	FS954C	208 240 380 480 575	B C D E F	120 208 240 380 480 575	A B C D E F	18 (457.2) High 24 (609.6) High	S X
2	— 15	— 15	15 25	15 25	25 —	30 60	FS954E FS954F	208 240 380 480 575	B C D E F	120 208 240 380 480 575	A B C D E F	24 (609.6) High 30 (762.0) High	S X
3	— 25	20 30	30 60	40 50	50 —	60 100	FS954H FS954J	208 240 380 480 575	B C D E F	120 208 240 380 480 575	A B C D E F	36 (914.4) High	S
4	— 50	— 50	— 60	60 100	75 100	100 200	FS954L FS954M	208 240 380 480 575	B C D E F	120 208 240 380 480 575	A B C D E F	54 (1371.6) High	S

③ Fuse clip ratings shown are based on Class RK1, 5 fuses.

④ For constant horsepower instead of constant/variable torque, see Option SV6 on Page 18.

Series 2100/5 Star Replacement Starter Units

Table 19. Reduced Voltage Autotransformer — Fusible ①

NEMA Size	Maximum Horsepower					Fuse Clip Amperes	Catalog Code	Service Voltage	Catalog Code	Control Voltage	Catalog Code	Space Options Inches (mm)	Catalog Code
	208V	240V	380V	480V	600V								
2	—	—	15	15	25	30 60	FS604E FS604F	208 240 380 480 575	B C D E F	120 208 240 380 480 575	A B C D E F	36 (914.4) High	S
	10	15	25	25	—								
3	—	20	30	40	50	60 100	FS604H FS604J	208 240 380 480 575	B C D E F	120 208 240 380 480 575	A B C D E F	60 (1524.0) High	S
	25	30	50	50	—								
4	—	—	—	60	75	100 200	FS604L FS604M	208 240 380 480 575	B C D E F	120 208 240 380 480 575	A B C D E F	72 (1828.8) High	S ②
	50	50	60	100	100								

① Fuse clip ratings shown are based on Class RK1, 5 fuses.

② If existing MCC is Back-to-Back design, 36 inches (914.4 mm) in bottom rear is unusable.

Table 20. Reduced Voltage Part Winding — Fusible ③

NEMA Size	Maximum Horsepower					Fuse Clip Amperes	Catalog Code	Service Voltage	Catalog Code	Control Voltage	Catalog Code	Space Options Inches (mm)	Catalog Code
	208V	240V	380V	480V	600V								
2	10	10	15	15	60	60	FS704D	208 240 380 480 575	B C D E F	120 208 240 380 480 575	A B C D E F	24 (609.6) High	S
	—	15	25	30	40								
2	—	15	25	30	40	60 200	FS704F FS704G	208 240 380 480 575	B C D E F	120 208 240 380 480 575	A B C D E F	24 (609.6) High	S
	20	25	40	40	—							30 (762.0) High	S
3	—	—	—	50	60	100 200	FS704J FS704K	208 240 380 480 575	B C D E F	120 208 240 380 480 575	A B C D E F	48 (1219.2) High	S
	40	50	75	75	75								
4	50	—	100	100	150	200 400	FS704M FS704N	208 240 380 480 575	B C D E F	120 208 240 380 480 575	A B C D E F	54 (1371.6) High	S
	75	75	150	150	—								

③ Fuse clip ratings shown are based on Class RK1, 5 fuses.

Series 2100/5 Star Replacement Starter Units

Table 21. Reduced Voltage Wye Delta Open Transition — Fusible ①

NEMA Size	Maximum Horsepower					Fuse Clip Amperes	Catalog Code	Service Voltage	Catalog Code	Control Voltage	Catalog Code	Space Options Inches (mm)	Catalog Code
	208V	240V	380V	480V	600V								
2	15	15	30	40	40	60	FS804F	208	B	120	A	30 (762.0) High	S
	20	25	40	—	—	100	FS804G	240 380 480 575	C D E F	208 240 380 480 575	B C D E F	36 (914.4) High	S
3	25	30	50	60	75	100	FS804J	208	B	120	A	36 (914.4) High	S
	40	50	75	75	—	200	FS804K	240 380 480 575	C D E F	208 240 380 480 575	B C D E F	48 (1219.2) High	S
4	50	60	100	125	150	200	FS804M	208	B	120	A	48 (1219.2) High	S
	60	75	150	150	—	400	FS804N	240 380 480 575	C D E F	208 240 380 480 575	B C D E F	72 (1828.8) High	S

① Fuse clip ratings shown are based on Class RK1, 5 fuses.

Table 22. Reduced Voltage Wye Delta Closed Transition — Fusible (Non-Chiller Application) ②

NEMA Size	Maximum Horsepower					Fuse Clip Amperes	Catalog Code	Service Voltage	Catalog Code	Control Voltage	Catalog Code	Space Options Inches (mm)	Catalog Code
	208V	240V	380V	480V	600V								
2	15	15	30	40	40	60	FS894F	208	B	120	A	30 (762.0) High	S
	20	25	40	—	—	100	FS894G	240 380 480 575	C D E F	208 240 380 480 575	B C D E F	36 (914.4) High	S
3	25	30	50	60	75	100	FS894J	208	B	120	A	48 (1219.2) High	S
	40	50	75	75	—	200	FS894K	240 380 480 575	C D E F	208 240 380 480 575	B C D E F		
4	50	60	100	125	150	200	FS894M	208	B	120	A	60 (1524.0) High	S
	60	75	150	150	—	400	FS894N	240 380 480 575	C D E F	208 240 380 480 575	B C D E F	72 (1828.8) High	S

② Fuse clip ratings shown are based on Class RK1, 5 fuses.

Series 2100/5 Star Unit Options

Table 23. Option Groups ①

Groups	Description	Page Number
A	Advantage Options	16
B	Circuit Breaker Options	16
C	Control Power Source Options	16
G	Ground Fault Protection Options	17
M	Metering Options	17
O	Overload Options	17
P	Pilot Device Options	17
R	Relay and Timer (Control, Voltage, Current) Options	18
S	Starter Contact Options	18
SV	Vacuum Starter Options	18
T	Terminal Block Options	18
U	Unit Wiring Options	18

① Select your option suffix and attach it to the end of the catalog number.

Table 24. Option Suffix

Suffix	Description	Space Required ②
--------	-------------	------------------

A — Advantage Options

A10	Substitute Advantage Starter Size 1	③
A11	Substitute Advantage Starter Size 2	③
A12	Substitute Advantage Starter Size 3	③
A13	Substitute Advantage Starter Size 4	③
A14	Substitute Advantage Starter Size 5	C ③④
A15	Advantage Hand/Off/Auto ACM for FVNR or RVNR Starters	C ④
A16	Advantage Stop/Start for FVNR or RVNR Starters	C ④
A17	Advantage Hand/Off/Auto-Start/Stop ACM for FVNR or RVNR Starters	C ④
A18	Advantage Fast/Slow/Stop 2-Speed Starters	C ④
A19	Advantage Forward/Reverse/Stop for Reversing Starters	C ④
A20	Advantage Fast/Slow/Off/Auto for 2-Speed Starters	C ④
A21	Advantage Forward/Reverse/Off/Auto for Reversing Starters	C ④
A22	ACM Metering Module	C ④
A23	WBELL Form C Bell Alarm Contact	C ④
A24	Reset with Overload Alarm and Trip Indication	C ④
A25	120V ac PLC Circuit Compatible Load Resistor	C ④
A26	WPONI PowerNet Communications Module	C ④
A27	Advantage Status Only ACM	C ④
A28	WPONIDNA DeviceNet Communications Module	C ④

B — Breaker Options

B10	Shunt Trip 120V AC Wired to Terminal Blocks for Remote Tripping	C
B11	Auxiliary Switch Form C (1NO/1NC) Wired to Terminal Blocks	C
B12	Form C Bell Alarm Contact (1NO/1NC) Wired to Terminal Blocks	C
B13	Undervoltage Release	C
B14	IQ Energy Sentinel — F Frame	③
B15	IQ Energy Sentinel — J Frame	③
B16	IQ Energy Sentinel — K Frame	③
B17	IQ Central Energy Display	③
B18	Thermal Magnetic Circuit Breaker Instead of HMCP	—

C — Control Power Source Options

C10	Control Fuse Wired for Separate Source in Lieu of Control Power Transformer	C
C11	Control Fuse with Disconnect for Separate Source in Lieu of Control Power Transformer	C
C12	Control Power Transformer 100 VA for Size 1 and 2 Starters (Fused)	C ④
C13	Control Power Transformer 150 VA for Size 3 and 4 Starters (Fused)	C
C14	Control Power Transformer 100 VA with Interposing Relay for Size 5 Starters, Fused	C
C15	Extra 50 VA for Control Power Transformer	S
C16	Extra 100 VA for Control Power Transformer	S
C17	Service Voltage Control, Fused in Lieu of Control Power Transformer	C
C18	Full Capacity Control Power Transformer for Size 5 Starters, Fused	C

② Minimum unit size required (refer to Replacement Unit pages).

③ Consult factory for spacing.

④ Not available in 6 inches (152.4 mm).

Series F2100/5 Star Unit Options

Table 24. Option Suffix (Continued)

Suffix	Description	Space Required ^①
G — Ground Fault Protection Options		
G10	Class 1 Ground Fault Protection — GRT1 Size 1 – 4	X
G11	Class 1 Ground Protection — GRT1 Size 5 – 6	X
G12	Ground Fault Test Panel	X
M — Metering Options		
M10	Mini Voltmeter	C ^②
M11	Mini Ammeter with Current Transformer	S
M12	Mini Elapsed Time Meter	C ^②
M13	Current Transformer for Remote Metering	S
M14	Current Transducer 4-20 mA Output	X
O — Overload Options		
O10	IQ 500 Solid-State Overload Relay	—
O11	IQ 500 Load Protection Module	—
O16	Bell Alarm (1NO) Wired	C
O17	Bi-Metallic Overload Substitution	C
O18	Adjustable A200 Overload Substitution	C
O19	Overload Relay Heater/Heater Pack	C
O20	CEP7 Solid-State Overload Relay	C
P — Pilot Device Options ^③		
P10	Red "RUN" Light	C
P11	Green "STOPPED" Light	C
P12	Amber "OVERLOAD TRIPPED" Light	C
P13	Green "RUN" Light	C
P14	Red "STOPPED" Light	C
P15	Red "RUN" Push-to-Test Light	C
P16	Green "STOPPED" Push-to-Test Light	C
P17	Amber "OVERLOAD TRIPPED" Push-to-Test Light	C
P18	Green "RUN" Push-to-Test Light	C
P19	Red "STOPPED" Push-to-Test Light	C
P20	Special Function Light	C
P30	"START" Pushbutton	C
P31	"STOP" Pushbutton	C
P32	"START/STOP" Pushbutton	C
P33	"ON" Pushbutton	C
P34	"OFF" Pushbutton	C
P35	"ON/OFF" Pushbutton	C
P36	"FORWARD/REVERSE/STOP" Pushbutton	C
P37	"FAST/SLOW/STOP" Pushbutton	C
P38	"FAST/OFF/SLOW" Pushbutton	C
P39	"HIGH/LOW/STOP" Pushbutton	C
P40	"HIGH/LOW/OFF" Pushbutton	C
P41	Special Function Pushbutton	C
P50	"ON-OFF" Selector Switch	C
P51	"HIGH-LOW" Selector Switch	C
P52	"OFF-AUTO" Selector Switch	C
P53	"START-STOP" Selector Switch	C
P54	"SLOW-FAST" Selector Switch	C
P55	"FORWARD-REVERSE" Selector Switch	C
P56	Special Function 2-Position Selector Switch	C
P57	"HAND-OFF-AUTO" Selector Switch	C
P58	"LOCAL-OFF-REMOTE" Selector Switch	C
P59	"FAST-OFF-SLOW" Selector Switch	C
P60	"HIGH-OFF-LOW" Selector Switch	C
P61	Special Function 3-Position Selector Switch	C
P62	"HIGH-LOW-OFF-AUTO" Selector Switch	C
P63	Special Function 4-Position Selector Switch	C

① Minimum unit size required (refer to Replacement Unit pages).

② Customer to supply range of meter required.

③ Available only with F2100, Advantage, Series 2100/5 Star, Freedom Unitrol, F10 Unitrol and Type W. Consult factory for specific size limitations.

Series F2100/5 Star Unit Options

Table 24. Option Suffix (Continued)

Suffix	Description	Space Required ^①						
R — Relay and Timer Options								
R10	Auxiliary Control Relay 2-Pole (1NO/1NC) Convertible Contacts Wired in Parallel with Starter Coil	S						
R11	Auxiliary Control Relay 4-Pole (2NO/2NC) Convertible Contacts Wired in Parallel with Starter Coil	S						
R12	Auxiliary Control Relay 2-Pole Overload Alarm (1NO/1NC) Convertible Contacts	S						
R13	Mechanical Latching Relay (Specify Connection)	X						
R14	Ice Cube Relay 300 Volts 3-Pole Blade Type (Specify Connection)	S						
R15	Phase Voltage Relay	X						
R16	Current Sensing Relay with Contacts Wired to Terminal Blocks	X						
R17	Deceleration Timing Relay (Pneumatic "OFF" Delay)	S						
R18	Compelling Timing Relay (Pneumatic "ON" Delay)	S						
R19	Time Clock 24 Hour	②						
R20	Time Clock 7 Day	②						
R21	Solid-State Timer Type TR (Specify Connection)	S						
R22	DN65 DeviceNet Interface Module	S						
R23	D15 2-Pole Control Relay	C						
R24	D15 4-Pole Control Relay	C						
S — Starter Contact Options (Maximum of 8 Contacts)								
S__	To order extra starter contacts, you must specify the number of NO/NC contacts, given a maximum of eight (8). To define the unit option required, create a suffix based on the following example:							
	<table border="1"> <thead> <tr> <th></th> <th>Quantity of Normally Open Contacts</th> <th>Quantity of Normally Closed Contacts</th> </tr> </thead> <tbody> <tr> <td>S</td> <td>2</td> <td>3</td> </tr> </tbody> </table>		Quantity of Normally Open Contacts	Quantity of Normally Closed Contacts	S	2	3	
	Quantity of Normally Open Contacts	Quantity of Normally Closed Contacts						
S	2	3						
SV — Vacuum Starter Options								
SV4	Vacuum Starter Size 4 Substitution FVNR	②						
SV5	Vacuum Starter Size 5 Substitution FVNR	②						
SV6	Constant Horsepower Instead of Constant/Variable Torque	—						
T — Terminal Block Options								
T10	Pull-apart Type Terminal Blocks (Standard on all Vintages Except Type W and 11-300)	S						
T11	Utility Screw Type Terminal Blocks (Add 6 Inches (152.4 mm) for Every 18 Points)	—						
T12	Front-mounted Pull-apart Terminal Block for F2100, Advantage, Series 2100/5 Star	S						
T13	T-Lead Power Terminal Blocks for Size 1 Starter	—						
U — Unit Wiring Options								
U10	Surge Suppressor on Coil	C						
U11	Type SIS Control Wire	C						
U12	Type SIS Power Wire	C						
U13	Type 14 Gauge Control Wire (Standard for all Vintages Except F2100, Series 2100/5 Star, Type W and 11-300)	C						
U14	Wiremarkers — Sleeve Type on all Control Wire	C						
U15	Locking Fork Terminals on all Control Wiring	S						
U16	Ring Wire Terminals on Power Wiring	S						
U17	Wiring Diagram Inside Starter Unit Door	C						
U18	Pre-insulated Ring Terminals on all Control Wiring	C						
U19	Pre-insulated Ring Terminals on all Control Wiring, except for Freedom Starter Terminals	C						
U20	Wiremarkers for Power Wiring	C						

① Minimum unit size required (refer to Replacement Unit pages).

② Consult factory for spacing.

Series 2100/5 Star Structure Parts

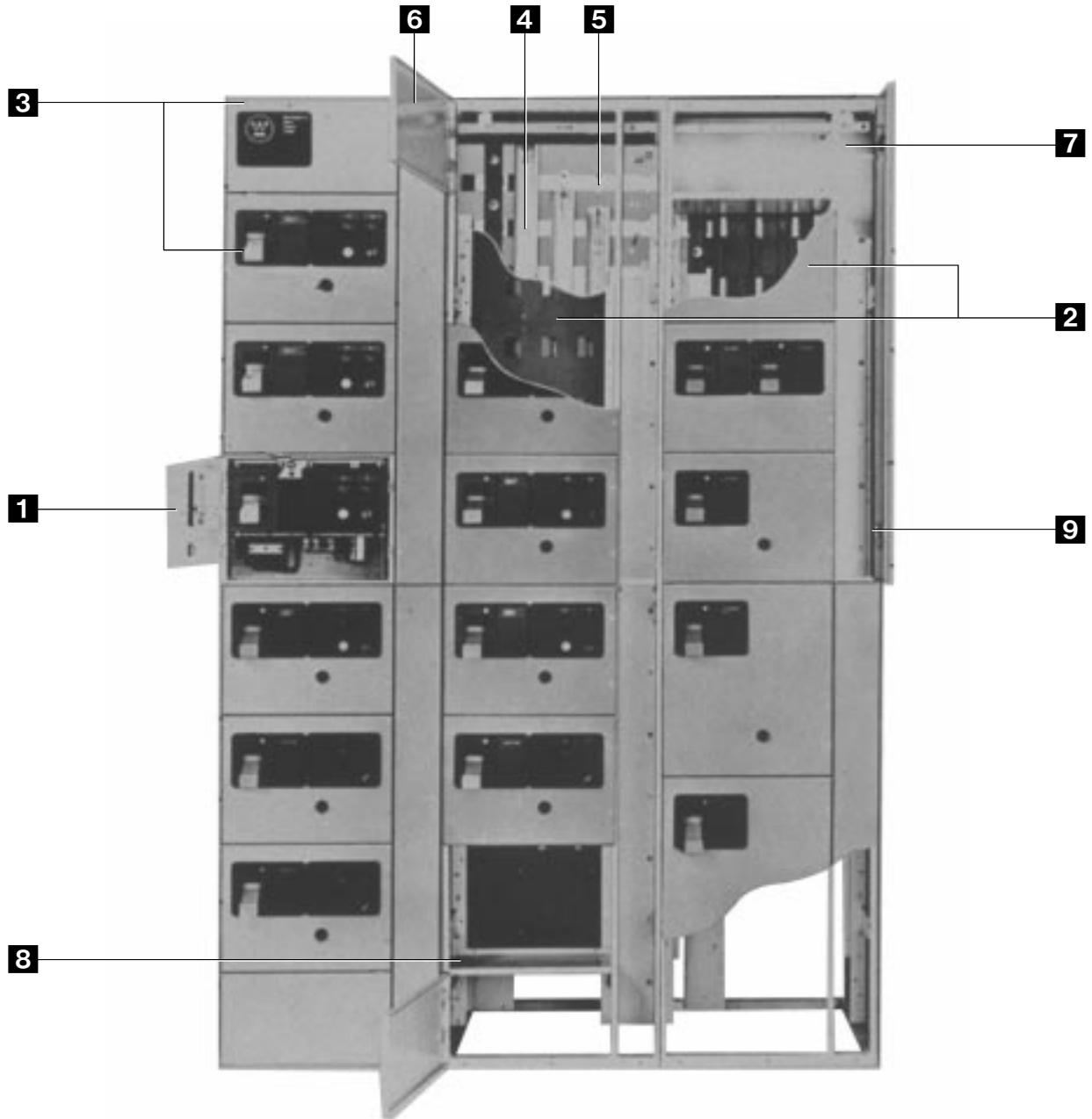

Table 25. Structure Parts

Reference	Description	Page
1	Blank Unit Door	20
2	Vertical Bus Barrier Kit Shutter Kit	20 20
3	Top and Side Sheet Metal Covers Touch-up Paint Kit	20 20
4	Vertical Bus Bar Vertical Bus Insulation Kit	20 20
5	Horizontal Bus Bar	21

Reference	Description	Page
6	Horizontal Wireway Door Kit	21
7	Horizontal Bus Barriers	21
8	Divider Pan/Guide Rails	21
9	Vertical Wireway Door Kit Horizontal to Vertical Bus Connection Kit Horizontal Bus Insulator Kit Horizontal Bus Splice Kit Door Mounting Hardware Kit	21 22 22 22 22

**Series 2100/5 Star
Structure Parts**

Vertical Bus Bar 2

65,000 ampere rms bus bracing

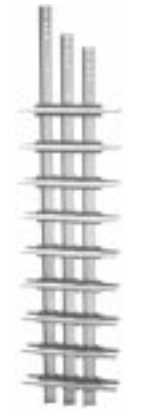

Vertical Bus Bar

Table 26. Vertical Bus Bar — Copper Only

Ampere Rating	Mounting Type	Style Number
300	Front	4719A80G01
600	Front/Back-to-Back	4719A80G02
800	Front	4719A80G04
1200	Front	4719A80G05

Vertical Bus Barrier Kits 2

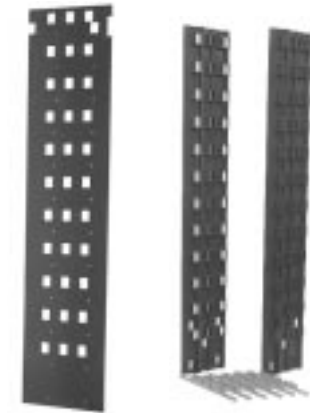

Standard Flat Barrier

Labyrinth Barrier Kit

Table 27. Vertical Bus Barrier Kit

Description	Style Number
Standard flat barrier kit includes one flat barrier, 12 covers and clips.	4719A91G13
Labyrinth barrier kit includes front and rear barrier, bus supports and hardware (does not include shutters).	4719A91G14

Vertical Bus Insulation Kit 2

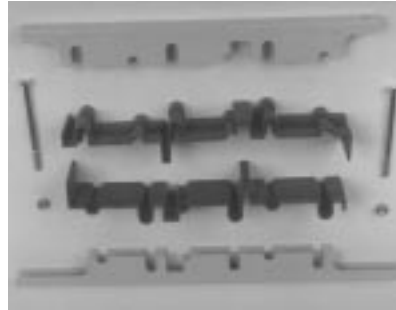

Vertical Bus Insulation Kit

Table 28. Vertical Bus Insulation Kit

Description	Style Number
Kit includes 2 insulators, 2 mounting brackets and mounting hardware.	4719A91G12

Sheet Metal Covers with Mounting Hardware 3

Table 29. Sheet Metal Covers with Mounting Hardware

Description	Style Number
Side Sheets	
16-Inches (406.4 mm) Deep, Front Mounted	4719A91G31
21-Inches (533.4 mm) Deep, Front Mounted	4719A91G32
21-Inches (533.4 mm) Deep, Back-to-Back Mounted	4719A91G33
Rear Sheets	
20-Inches (508.0 mm) Wide x 90-Inches (2286.0 mm) High	4719A91G34
24-Inches (609.6 mm) Wide x 90-Inches (2286.0 mm) High	4719A91G35
Top Sheets	
20-Inches (508.0 mm) Wide x 16-Inches (406.4 mm) Front Mounted	4719A91G36
20-Inches (508.0 mm) Wide x 21-Inches (533.4 mm) Front Mounted	4719A91G37
20-Inches (508.0 mm) Wide x 21-Inches (533.4 mm) Back-to-Back Mounted	4719A91G38
24-Inches (609.6 mm) Wide x 16-Inches (406.4 mm) Front Mounted	4719A91G39
24-Inches (609.6 mm) Wide x 21-Inches (533.4 mm) Front Mounted	4719A91G40

Shutter Kit 2

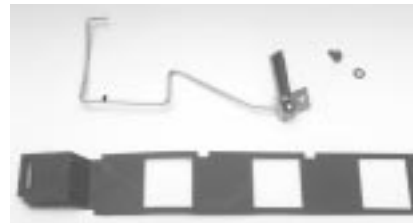

Shutter Kit

Table 30. Shutter Kit

Description	Style Number
Kit includes shutter, spring loaded coupler and mounting screws.	4719A91G15

Blank Unit Door with Mounting Hardware 1

Table 31. Blank Unit Door with Mounting Hardware

Description	Style Number
6-Inches (152.4 mm) High x 15-1/2 Inches (393.7 mm) Wide	4719A91G20
12-Inches (304.8 mm) High x 15-1/2 Inches (393.7 mm) Wide	4719A91G21
18-Inches (457.2 mm) High x 15-1/2 Inches (393.7 mm) Wide	4719A91G22
24-Inches (609.6 mm) High x 15-1/2 Inches (393.7 mm) Wide	4719A91G23
30-Inches (762.0 mm) High x 15-1/2 Inches (393.7 mm) Wide	4719A91G24
36-Inches (914.4 mm) High x 15-1/2 Inches (393.7 mm) Wide	4719A91G25

Touch-up Paint Kit 3

Table 32. Touch-up Paint Kit

Description	Style Number
Kit includes three spray cans of ANSI-61 Gray.	4719A91G10

Series 2100/5 Star Structure Parts

Horizontal Bus Bar

65,000 ampere rms bus bracing.

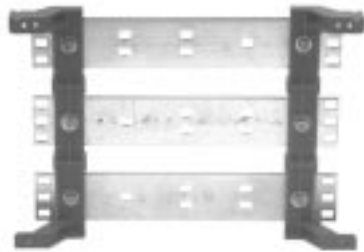

Horizontal Bus Bar

Table 33. Horizontal Bus Bar — Tin-Plated Copper

Structures Number	Width Inches (mm)	Bar Size Inches (mm)	Bars/ Phase	Ampere Rating		Style Number
				UL (50°C)	NEMA (65°C)	
1	20 (508.0)	1/4 x 2 (6.4 x 50.8)	1	600	600	4719A97G28 4719A97G29 4719A97G30
2	40 (1016.0)					
3	60 (1524.0)					
1	20 (508.0)	1/4 x 2 (6.4 x 50.8)	1	—	800	4719A97G31 4719A97G32 4719A97G33
2	40 (1016.0)					
3	60 (1524.0)					
1	20 (508.0)	1/4 x 3 (6.4 x 76.2)	1	—	1000	4719A97G34 4719A97G35 4719A97G36
2	40 (1016.0)					
3	60 (1524.0)					
1	20 (508.0)	1/4 x 3 (6.4 x 76.2)	2	—	1200	4719A97G37 4719A97G38 4719A97G39
2	40 (1016.0)					
3	60 (1524.0)					
1	20 (508.0)	1/4 x 3 (6.4 x 76.2)	1	800	—	4719A97G40 4719A97G41 4719A97G42
2	40 (1016.0)					
3	60 (1524.0)					
1	20 (508.0)	1/4 x 2-1/2 (6.4 x 63.5)	2	1200	—	4719A97G43 4719A97G44 4719A97G45
2	40 (1016.0)					
3	60 (1524.0)					

Horizontal Wireway Door Kit



Horizontal Wireway Door Kit

Table 34. Horizontal Wireway Door Kit

Description Inches (mm)	Style Number
9 (228.6) High x 15-1/2 (393.7) Wide (Standard Kit of 2)	4719A91G18
(1) 15 (381.0) High x 15-1/2 (393.7) Wide, (1) 3 (76.2) High	4719A91G19

Horizontal Bus Barrier Kit



Horizontal Bus Barrier Kit

Table 35. Horizontal Bus Barrier Kit

Description Inches (mm)	Style Number
9 (228.6) High, Front Mounted	4719A91G02
15 (381.0) High, Front Mounted	4719A91G03
15 (381.0) High, Rear Mounted	4719A91G04

Kit includes divider pan, horizontal and vertical barriers, junction piece, and mounting hardware.

Divider Pan/Guide Rails with Mounting Hardware



Divider Pan/Guide Rails with Mounting Hardware

Table 36. Divider Pan/Guide Rails with Mounting Hardware

Description	Style Number
Divider pan/guide rails with mounting hardware.	4719A91G05

Vertical Wireway Door Kit



Vertical Wireway Door Kit

Table 37. Vertical Wireway Door Kit

Description Inches (mm)	Style Number
Kit includes 4 x 45 (101.6 x 1143.0) door, hinges, hinge pins and mounting hardware.	4719A91G17

Series 2100/5 Star Structure Parts

Horizontal to Vertical Bus Connection Kit



Horizontal to Vertical Bus Connection Kit

Table 38. Horizontal to Vertical Bus Connection Kit

Description	Horizontal Bus		Vertical Bus		Style Number
	Ampere Rating	Bars/Phase	Ampere Rating	Material	
Kit includes bus spacers with mounting hardware.	600	1	300	Cu	4719A97G64
			600	Cu	4719A97G65
	800	2	300	Cu	4719A97G72
			600	Cu	4719A97G73
			800	Cu	4719A97G74
	1200	3	300	Cu	4719A97G80
			600	Cu	4719A97G81
			800	Cu	4719A97G82
			1200	Cu	4719A97G84

Horizontal Bus Splice Kit



Horizontal Bus Splice Kit

Table 39. Horizontal Bus Splice Kit — Tin-Plated Copper

Description	Bus Ampere Rating		Bus Size Inches (mm)	Bars/ Phase	Style Number
	UL (50°C)	NEMA (65°C)			
Kit includes bus splice plates with mounting hardware.	600	600	2 (50.8)	1	4719A97G86
	—	800	2 (50.8)	1	4719A97G87
	800	—	3 (76.2)	1	4719A97G88
	—	1000	3 (76.2)	1	4719A97G89
	1000	1200	3 (76.2)	2	4719A97G90
	1200	—	2-1/2 (63.5)	2	4719A97G91

Horizontal Bus Insulator Kit



Horizontal Bus Insulator Kit

Table 40. Horizontal Bus Insulator Kit

Description	Style Number
Kit includes 2 insulators with mounting hardware.	4719A91G11

Door Mounting Hardware Kit



Door Mounting Hardware Kit

Table 41. Door Mounting Hardware Kit

Description	Style Number
Kit includes 2 hinges, hinge pins and (2) 1/4 turn latches.	4719A91G26

Series 2100/5 Star Unit Parts

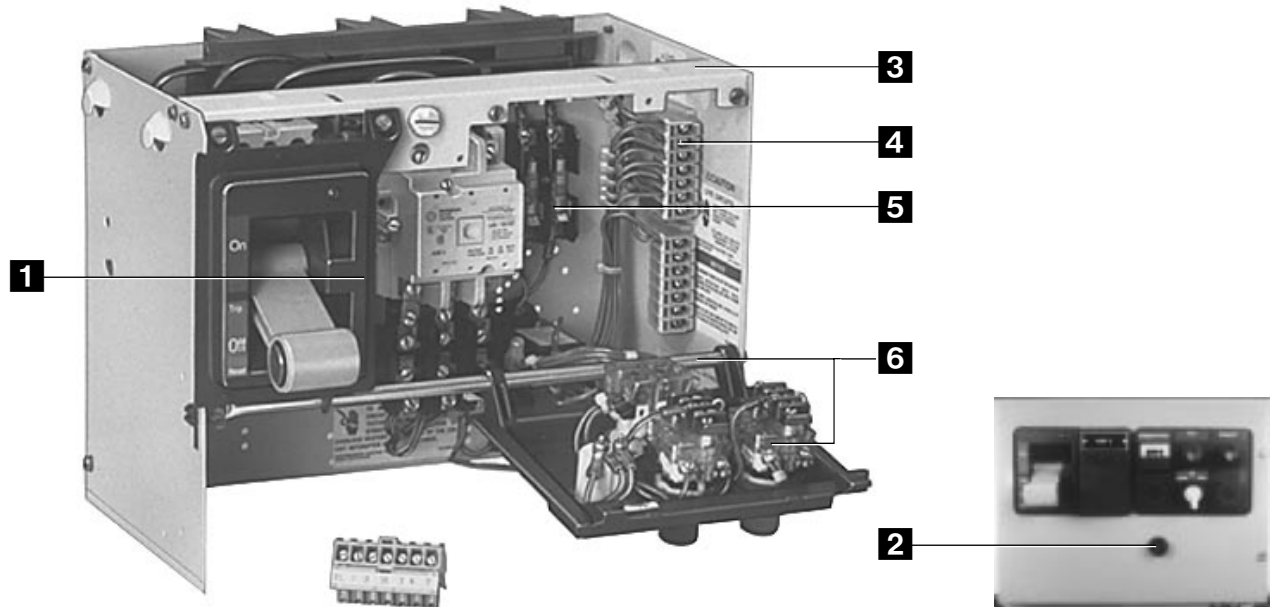

Table 42. Unit Parts

Reference	Description	Page
1	Operating Handle Mechanism	23
2	Overload Reset Button and Reset Rod Extension Kit	23
3	Unit Drawout Top Rail	24
4	Terminal Blocks	24

Reference	Description	Page
5	Control Transformers Primary/Secondary Fuse Holder Kit	24 24
6	Device Panel/Pivot Tube Fusible Disconnect Block Kit	24 24

Operating Handle Mechanism Kit 1

Kit includes operating arm, adjustable linkage, and mounting hardware.



Operating Handle Mechanism Kit

Table 43. Operating Handle Mechanism Kit

Description	Style Number
Circuit Breaker Units	
FB/MCP	4719A92G43
KB	4719A92G05
HFD/HMCP	4719A88G01
HMCPE	4700A99G69
HLD	4700A99G65
HJD/HKD	4719A89G01
LB	4719A92G06
MA/MC	4719A92G07
NB	4719A92G08
FCL	4719A92G44
LCL	4719A92G45
HFD/HMCP (6-Inch Unit)	4719A92G56
Fusible Switch Units	
30/60/100A DS Switch	4719A92G09
200/400A DS Switch	4719A92G10

Overload Reset Button and Reset Rod Extension Kit 2



Overload Reset Button and Reset Rod Extension Kit

Table 44. Overload Reset Button and Reset Rod Extension Kit

Description	Style Number
For A200 starters, the kit includes reset button, extension rod and "O" ring.	4719A92G04

Series 2100/5 Star Unit Parts

Unit Drawout Top Rail



Unit Drawout Top Rail

Table 45. Unit Drawout Top Rail

Description	Style Number
Unit Top Rail with Hardware	4719A92G02

Primary/Secondary Fuse Holder Kit

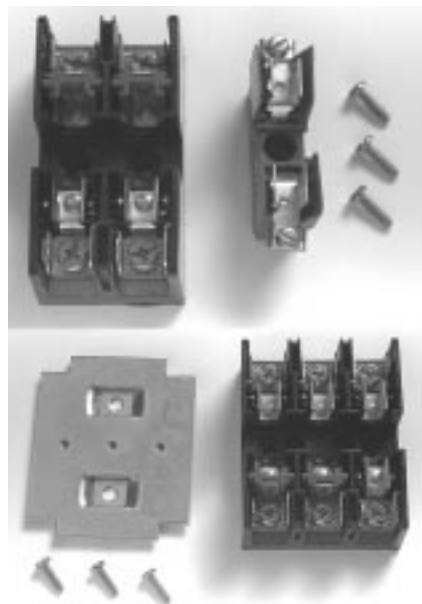

Primary/Secondary Fuse Holder Kit

Table 46. Primary/Secondary Fuse Holder Kit

Description	Style Number
5 Star kit includes fuse block, mounting bracket and screws.	4719A92G01
Series 2100 kit includes fuse block, mounting bracket and screws.	4719A92G59

Terminal Blocks



Terminal Blocks

Table 47. Terminal Blocks

Description	Style Number
White, 7 Circuit, Pull-apart	4719A92G57

Device Panel/Pivot Tube with Mounting Hardware



Device Panel/Pivot Tube with Mounting Hardware

Table 48. Device Panel/Pivot Tube with Mounting Hardware

Description	Style Number
Device panel/pivot tube with mounting hardware.	4719A92G03

Control Transformers (480/240V to 120V Single-Phase)

Table 49. Control Transformers (480/240V to 120V Single-Phase)

Description	Style Number
50 VA	4719A92G46
100 VA	4719A92G48
150 VA	4719A92G49
200 VA	4719A92G50
250 VA	4719A92G51
300 VA	4719A92G52
350 VA	4719A92G53
500 VA	4719A92G54

Fusible Disconnect Block Kit

For use with DS type switch.



Fusible Disconnect Block Kit

Kit includes line and load blocks with clips.

Table 50. Fusible Disconnect Block Kit ^{①②}

Description	Style Number
30A Non-rejection	4719A92G33
30A Rejection	4719A92G34
60A Non-rejection	4719A92G35
60A Rejection	4719A92G36
100A Non-rejection	4719A92G37
100A Rejection	4719A92G38
200A Non-rejection	4719A92G39
200A Rejection	4719A92G40
400A Non-rejection	4719A92G41
400A Rejection	4719A92G42

① Certain fusible designs have line fuse clips mounted on the DS Switch. Non-rejection clips can be removed from the mounting block and mounted on the switch. Rejection clips are non-removable. Order a complete switch assembly.

② For MCCs built after October 1984, consult factory for specific details.

Series C® Retrofit Kits

Series C Retrofit Kits are to be used to upgrade existing Type W and 5 Star Motor Control Center buckets by changing out the old breakers with the Series C. These kits can be applied to both starter and feeder units.

The old breakers that these kits will upgrade include, but are not limited to, the MCP, F, FA, FB, HFB, K, KA, KB, HKB, L, LA, LB and HLB breakers.

5 Star Series C Retrofit Kit



5 Star Series C Retrofit Kit

The 5 Star Series C Retrofit Kit includes:

- Series C device, 65 kA (either HMCP or thermal-magnetic breaker).
- Operating handle mechanism, including tripped indication and push-to-trip.
- Label stating that the MCC unit has been retrofitted with Series C device suitable for 65 kA (similar to UL quality label).
- Templates for desired frame size.
- Assembly instructions.

Type W Series C Retrofit Kit

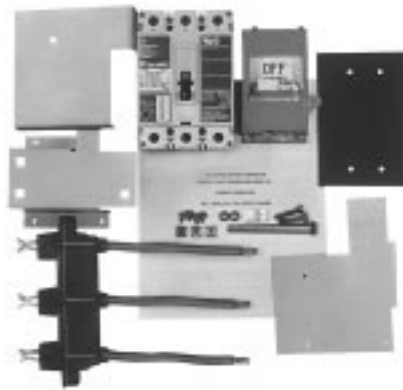

Type W Series C Retrofit Kit

The Type W Series C Retrofit Kit includes:

- Series C device, 65 kA (either HMCP or thermal-magnetic breaker).
- Operating handle mechanism, including tripped indication and push-to-trip.
- Label stating that the MCC unit has been retrofitted with Series C device suitable for 65 kA (similar to UL quality label).
- Templates for proper hole placement for desired frame size.
- Series C breaker mounting hardware.
- New door and hardware.
- New stab assembly.
- Assembly instructions.

F10 Series C Retrofit Kit



F10 Series C Retrofit Kit

The F10 Series C Retrofit Kit includes:

- Series C device, 65 kA (either HMCP or thermal-magnetic breaker).
- Operating handle mechanism, including tripped indication push-to-trip.
- Label stating that the MCC unit has been retrofitted with Series C device suitable for 65 kA (similar to UL quality label).
- Templates for desired frame size.
- Assembly instructions.

How to Order

1. Select the correct Series C device from the table in the applicable RPD 5 Star — RP04304003E Type W — RP04304006E F10 — RP04304005E
2. Create a catalog number based on the MCC Type, Device Selected, Modification, Door Size and Device Panel.

Select price from PL04304002E.

Table 51. Series C Retrofits, Catalog Numbering System

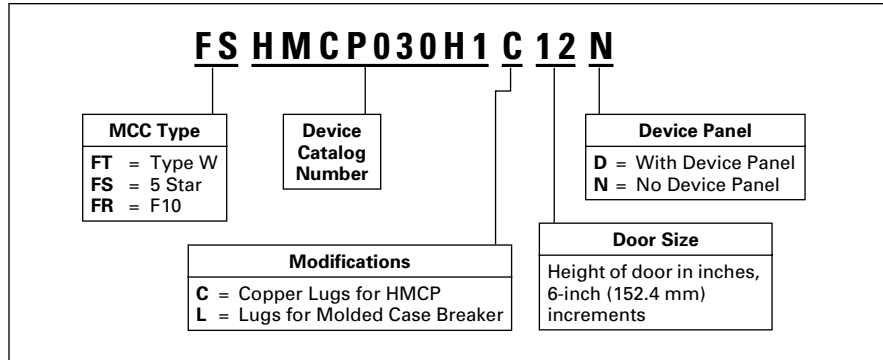

Table 52. Series 2100/5-Star Series C Breaker Retrofit Upgrade Kit

Catalog Number	Catalog Number	Catalog Number	Catalog Number	Catalog Number
FSHMCP003A0	FSHMCP250D5	FSHMCP400X5	FSFDC3020	FSHJD3250
FSHMCP007C0	FSHMCP250F5	FSHFD3015	FSFDC3025	FSJDC3175
FSHMCP015E0	FSHMCP250G5	FSHFD3020	FSFDC3030	FSJDC3200
FSHMCP025D0	FSHMCP250J5	FSHFD3025	FSFDC3040	FSJDC3225
FSHMCP030H1	FSHMCP250K5	FSHFD3030	FSFDC3050	FSJDC3250
FSHMCP050G2	FSHMCP250L5	FSHFD3040	FSFDC3060	FSHKD3300
FSHMCP050K2	FSHMCP250W5	FSHFD3050	FSFDC3070	FSHKD3350
FSHMCP070J2	FSHMCP400D5	FSHFD3060	FSFDC3080	FSHKD3400
FSHMCP070M2	FSHMCP400F5	FSHFD3070	FSFDC3090	FSKDC3300
FSHMCP100L3	FSHMCP400G5	FSHFD3080	FSFDC3100	FSKDC3350
FSHMCP100R3	FSHMCP400J5	FSHFD3090	FSFDC3125	FSKDC3400
FSHMCP150T4	FSHMCP400K5	FSHFD3100	FSFDC3150	—
FSHMCP150U4	FSHMCP400L5	FSHFD3125	FSHJD3175	—
FSHMCP250A5	FSHMCP400W5	FSHFD3150	FSHJD3200	—
FSHMCP250C5	FSHMCP400R5	FSFDC3015	FSHJD3225	—

Note: Entire catalog number is not listed above and will not affect price.

How to Create a Catalog Number

After selecting the circuit device required, create a **Dual Mounted** feeder unit catalog number based on the following:

Note: Catalog number varies in length based on single or dual mounted unit.

Table 53. Catalog Numbering System Example

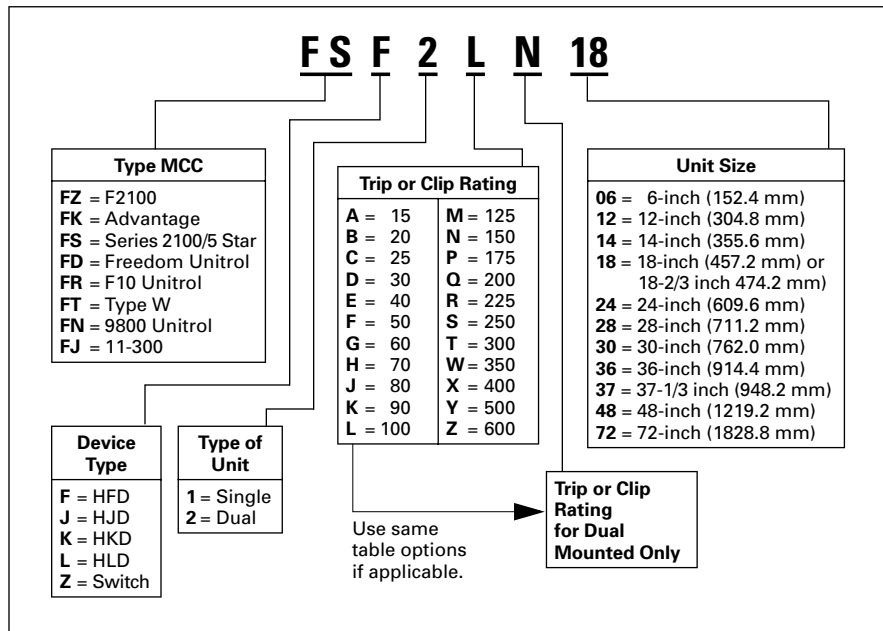

Replacement Feeder Units

Product Description

Each Feeder Unit consists of a single mounted 3-pole molded case circuit breaker or fusible switch (dual mounted are also available). Each unit includes a new wrapper, stab assembly, door, handle mechanism and customer specific disconnect device. They are shipped assembled and ready to install into the existing motor control center.

The following are simple steps to select and order a new feeder unit:

Step 1

Select the circuit device required from **Table 54** below.

Step 2

Verify the amount of space available.

Step 3

Create a catalog number from the formula on **Table 53** on **Page 26**.

Unit options and modifications for replacement feeder units:

For factory installed molded case circuit breaker modifications or additional unit options, contact the factory for prices and availability.

Table 54. Electrical Characteristics and Space Requirements of Molded Case Circuit Breakers and Fusible Switch Replacement Feeder Units — Inches (mm)

Device Type	Maximum Amperes	Interrupting Rating (kAIC)			Trip Rating or Clip	Freedom 2100 Series 2100/5 Star Advantage		Freedom Unitrol		F10		Type W		9800		11-300				
		240V	480V	600V		Single	Dual	Single	Dual ^①	Single	Dual ^①	Single	Dual	Single	Dual ^①	Single	Dual			
HFD	150	100	65	25	15															
					20															
					25															
					30															
					40															
					50															
					60															
70																				
					80	6 ^② (152.4)		6 ^② (152.4)												
					90	12 ^③ (304.8)	12 (304.8)	12 ^③ (304.8)	12 (304.8)	12 ^③ (304.8)	12 (304.8)	12 ^③ (304.8)	12 (304.8)	14 (355.6)	14 (355.6)	14 (355.6)	14 (355.6)			
					100															
					125	12 (304.8)	12 (304.8)	12 (304.8)	18 (457.2)	12 (304.8)	18 (457.2)	12 (304.8)	12 (304.8)	14 (355.6)	18 (457.2)	14 (355.6)	14 (355.6)			
					150	12 ^③ (304.8)						12 ^③ (304.8)								
HJD	250	100	65	25	175															
					200															
					225	18 (457.2)		24 (609.6)		18 (457.2)		18 (457.2)		18 (457.2)		14 (355.6)				
					250															
HKD	400	100	65	35	300															
					350															
					400	24 (609.6)		24 ^④ (609.6)		24 ^④ (609.6)		24 (609.6)		28 ^④ (711.2)		14 (355.6)				
HLD	600	100	65	35	500															
					600	24 (609.6)		24 ^④ (609.6)		24 ^④ (609.6)										
Fusible Switch	30	100	100	100	30	12 (304.8)	12 ^③ (304.8)	12 (304.8)	18 (457.2)	12 (304.8)	18 (457.2)	12 (304.8)	12 ^③ (304.8)	14 (355.6)	18 (457.2)	14 (355.6)	14 (355.6)			
	60	100	100	100	60	12 (304.8)	12 ^③ (304.8)	12 (304.8)	18 (457.2)	18 (457.2)	18 (457.2)	12 (304.8)	12 ^③ (304.8)	14 (355.6)	18 (457.2)	14 (355.6)	14 (355.6)			
	100	100	100	100	100	18 (457.2)		18 (457.2)		18 (457.2)		12 ^③ (304.8)		18 (457.2)		18 (457.2)	18-2/3 (474.2)			
	200	100	100	100	200	36 (914.4)		30 (762.0)		30 (762.0)		24 (609.6)		28 (711.2)		28 (711.2)				
	400	100	100	100	400	36 (914.4)		72 ^④ (1828.8)		48 ^④ (1219.2)		42 (1066.8)		42 ^④ (1066.8)		42 (1066.8)				
	600	100	100	100	600	48 (1219.2)		72 ^④ (1828.8)												

① Combined ampacity no greater than 150A for 12-inch (304.8 mm) height. For greater than 150A, 18-inch (457.2 mm) required.

② 100A maximum.

③ Available in 18-inch (457.2 mm) height.

④ Cable in/cable out, no stab assembly.

NEMA is the registered trademark and service mark of the National Electrical Manufacturers Association. UL is a registered trademark of Underwriters Laboratories Inc.

Eaton Corporation
Cutler-Hammer business unit
1000 Cherrington Parkway
Moon Township, PA 15108-4312
USA
tel: 1-800-525-2000
www.cutler-hammer.eaton.com