

Project		Catalog #		Type	
Prepared by		Notes		Date	



Metalux

Vaportite LED

4' Industrial LED Lamp Vaportite Industrial Refrigerated Case

Typical Applications

Parking Garage • Cold Storage • Canopy • Warehouse • Food Processing • Manufacturing • Complex Environments

Interactive Menu

- Order Information page 2
- Photometric Data page 3
- Product Warranty

Product Certification



Product Features



Top Product Features

- 2ft, 4ft, and 8ft Sealed and Gasketed Vaportite
- Lumen packages up to 22K lumens
- High-Performance efficacy up to 150 LPW
- LEDs available in 3500K, 4000K and 5000K at 80 CRI
- Rated for -40c to 35c ambient
- Options to meet Buy American and other domestic preference requirements

Dimensional and Mounting Details

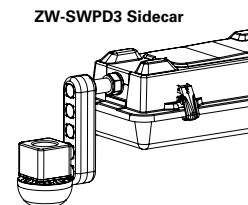
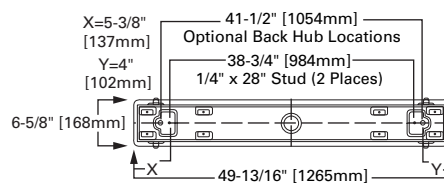
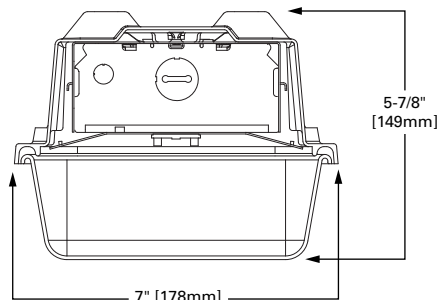

Installation Data



MOUNTING BRACKETS
Furnished
Two per 2' and 4' Unit
Four per 8' Unit

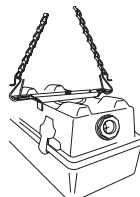

OPTIONAL CHAN HANGING SET
(VT2-CHAIN/SET-U)
Includes 6 ft. of chain, 4 large S-Hooks and 4 small S-Hooks
Order One (1) Kit for each 2' or 4' Fixture

Order Information

SAMPLE ORDER NUMBER: **4VT2-LD5-4-DR-UNV-L840-CD1-WL-U**

Domestic Preferences	Series	Lamp Type	LED Lumens Output	Lens	Distribution	Voltage	Remote Emergency Enclosure
Domestic Preferences ⁽¹⁾	Series ⁽²⁾	Lamp Type	LED Lumens Output	Lens	Distribution	Voltage	Remote Emergency Enclosure
[Blank] =Standard BAA =Buy American Act TAA =Trade Agreements Act	4VT2 =4' Vaportite	LD5 =LED 5.0	4 =4000 Lumens 6 =6000 Lumens 8 =8000 Lumens 11 =11000 Lumens	DR =Internal Prismatic Lens/15% DR High Impact Additive DR100 =Internal Prismatic Lens/100% DR High Impact Additive FR50 =Frosted Lens/15% DR High Impact Additive ⁽³⁾	[Blank] =Medium (Standard) W =Wide Distribution	347V =347 Volt UNV =Universal Voltage 120-277	EL10W =10-watt, 120-277V emergency battery pack installed ⁽⁴⁾ VT-REM-EL =Remote Emergency Installed, 700 lumens ⁽⁴⁾
Notes (1) Only product configurations with these designated prefixes are built to be compliant with the Buy American Act of 1933 (BAA) or Trade Agreements Act of 1979 (TAA), respectively. Please refer to DOMESTIC PREFERENCES website for more information. Components shipped separately may be separately analyzed under domestic preference requirements.	Notes (2) DesignLights Consortium® Qualified and classified for both DLC Standard and DLC Premium, refer to www.designlights.org for details.			Notes (3) Not available in wide distribution.			Notes (4) EL must specify 120 or 277V only.

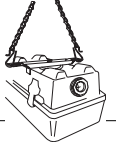
Lamps	Driver Type	Label	Options	Packaging	Accessories
Lamps	Driver Type	Label	Options	Packaging	Accessories (order separately) ⁽⁷⁾
L835 =3500K, LED L840 =4000K, LED L850 =5000K, LED	CD1 =1 Dimming Driver 5LTD1 =Fifth Light DALI	WL =Wet Location Label	SSL =Stainless Steel Latches GL =Single Element Fuse TH =(2) Top Watertite Hubs TEH =(2) Top and (2) End Watertite Hubs (all Watertite Hubs have 1/2" Conduit Entry) MS =Damp Listed Motion Sensor MSWL20 =Wet Listed Motion Sensor, max 20ft mounting height ZW-SWPD3 =WaveLinX Wireless Sensor, Sidecar mount, with 1200 sq ft. coverage ⁽⁶⁾	U =Unit Pack	VT2-Chain/Set-U =Chain Hanging Set. Includes 6 ft. of chain, 4 large S-Hooks and 4 small S-Hooks Order One (1) Kit for each 2' or 4' Fixture VT2-SS-MBK =Stainless Steel Mounting Bracket 
			Notes (6) Not available in 11,000 lumen fixture. Not available with 347V, 480V, or UNC. Not available with 5LTD option.		Notes (7) Accessories sold separately will be separately analyzed under domestic preference requirements. Consult factory for further information.

Product Specifications

Construction

- Rugged and durable construction
- Fiberglass housing is reinforced polyester and self-extinguishing (ASTM-D635-74) plastic
- Full metal fixture liner
- Watertight housing
- 1/2" conduit entry at each end of housing (standard) for continuous feed
- Polyurethane gasketing provides a continuous seamless seal for the diffuser lens
- Four sturdy cam latches clamp diffuser tightly for a positive seal between housing, gasketing and diffuser
- Surface or chain mounting

Electrical

- Long-Life LED system coupled with electrical driver for optimal performance
- LED's available in 3500K, 4000K and 5000K with a CRI ≥ 80
- Projected life is 60,000 hours at 91% lumen output
- Electronic drivers are available for 120-277V applications
- 0-10V dimming control (standard)
- Operating temperature of -40°C to 35°C; Ideal for cold storage environments

Lens

- High-impact diffuser lens
- Internal Prismatic Lens with 15% DR High Impact Additive (DR) or Internal Prismatic Lens with 100% DR High Impact Additive (DR100)
- Frosted Lens with 15% DR High Impact Additive (FR50) option

Finish

- Housing is permanent pearl gray color

Warranty

- Five-year limited warranty

Compliance

- UL/cUL listed for Wet location
- RoHS compliant
- LED modules comply with IESNA LM-79 and LM-80 standards
- NSF listed
- DesignLights Consortium® Qualified and classified for both DLC Standard and DLC Premium (refer to [www.designlights.org](#) for details)
- The VT2 Series ratings apply to Horizontal Mounting only

Photometric Data

[View IES files](#)

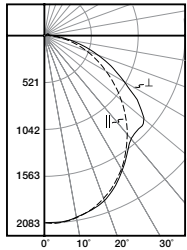

4VT2-LD5-6-DR-UNV-L840-CD1-WL-U
 Electronic Driver
 Linear LED 4000K
 Spacing criterion: (H) 1.21 x mounting height,
 (L) 1.22 x mounting height
 Lumens: 6197
 Input Watts: 50.6W
 Efficacy: 122.5 lm/W
 Test Report:
 4VT2-LD5-6-DR-UNV-L840-CD1-WL-U.IES

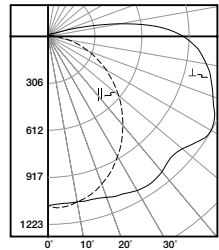

4VT2-LD5-6-DR-W-UNV-L840-CD1-WL-U
 Electronic Driver
 Linear LED 4000K
 Spacing criterion: (H) 1.22 x mounting height,
 (L) 1.6 x mounting height
 Lumens: 5931
 Input Watts: 50.6W
 Efficacy: 117.2 lm/W
 Test Report:
 4VT2-LD5-6-DR-W-UNV-L840-CD1-WL-U.IES

Energy and Performance Data

Lumen Maintenance

Ambient Temperature	TM-21 Lumen Maintenance (60,000 hours)	Theoretical L70 (Hours)
25°C	> 91%	> 237,000

Shipping Data

Catalog No.	Wt.
4VT2-LD5	18 lbs.

Input Watts:

4VT2-LD5-4 (4,000 lumens)=30W
4VT2-LD5-6 (6,000 lumens)=51W
4VT2-LD5-8 (8,000 lumens)=58W
4VT2-LD5-11 (11,000 lumens)=82W