

Current Eaton panelboards

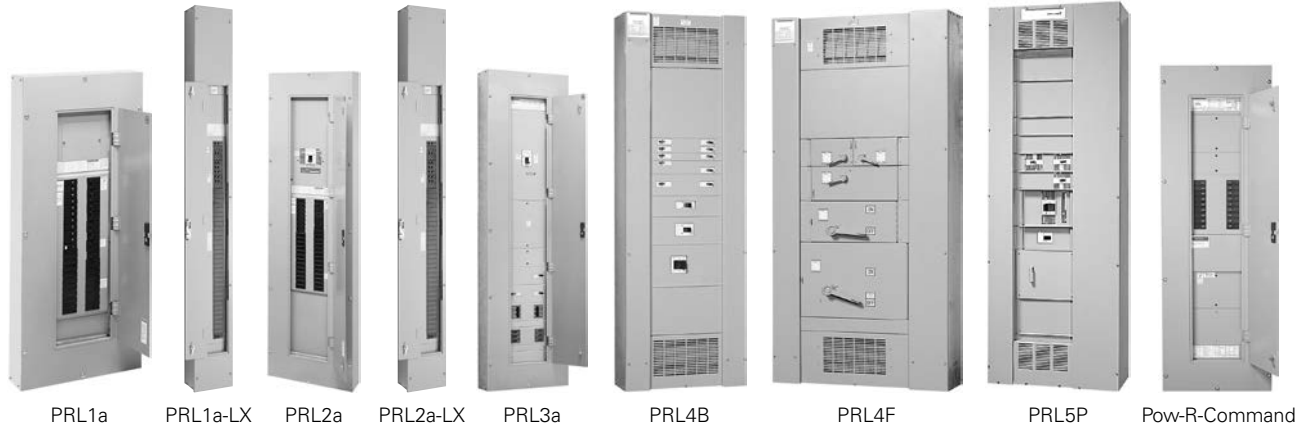

Contents

Description	Page	Description	Page
Procedure for identifying panelboard type	2	PRL4 parts	
Procedure for identifying renewal parts	2	Vented cover assemblies and side gutter covers	23
Distributor ordering instructions	2	Blank covers	24
Eaton satellite plants	3	Breaker connector kits	24
PRL1a, 2a parts		Fusible connector kits	25
Connector kits, vertical breakers	4	Breaker retrofit kits	26
Connector kits, lug assemblies	5	Fusible retrofit kits	27
Connector kits, horizontally mounted, PRL1a	8	PRL1a, 2a, 3a EZ trims and enclosures	27
Neutral assemblies	11	PRL1a, 2a, 3a special trims and enclosures	28
Ground assemblies	15	PRL4 special trims and enclosures	29
Service entrance bonding jumper kits	15	Type 12/3R enclosures	30
Service entrance main breaker kits	15	Ordering procedure	30
Deadfront covers	16	PRL5P parts	
Special trim locks	18	Chassis layout	31
EZ trim locks	18	Breaker adapter unit catalog numbers	32
Fastrim clamps and hardware kits	18	Branch breaker information	32
PRL3a parts		Main or through-feed lugs	33
Connector kits assemblies	19	Neutrals and grounds	34
Ground assemblies	20	Boxes, trims, and filler plates	34
Service entrance bonding jumper kits	20	PRL1a, 2a-LX column panelboards	35
Service entrance main breaker kits	20	Pow-R-Command	35
Deadfront covers	20	Additional services	35



Powering Business Worldwide

Effective October 2017

Table 1. Product history time line

Product	1985	1990	1995	Present
PRL1a, 2a			← Oct. 1996 →	
PRL3a			← Mar. 1994 →	
PRL4B/F	←			→ Oct. 1987 →
PRL5P			← Aug. 1995 →	
PRL1a, 2a-LX			← Dec. 1997 →	
Pow-R-Command™			← Mar. 1996 →	

Procedure for identifying panelboard type

The current line of Pow-R-Line C™ panelboards was introduced in 1993.

A panelboard is identified by data found on the nameplate. Pow-R-Line C panelboard nameplates are different in appearance, but all have the same critical information:

- Ampere rating of the main
- Ampere rating of the neutral
- Type of service (phase/wire)
- Manufacturing location
- Type of panel
- General order number

In the event the nameplate is missing, it may still be possible to identify the panel type by location of the neutral bar. **Figure 1** shows the position of the neutral in the panelboard.

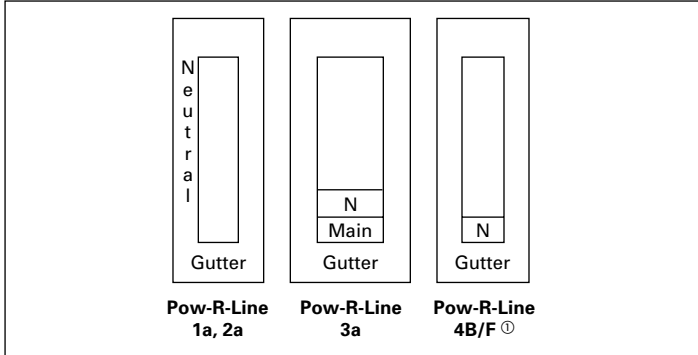

Figure 1. Position of the neutral in the panelboard

① PRL4F panels with vertical-mounted main switch will have the neutral mounted at the opposite end the main.

Box width may also help identify the panelboard type. Standard width for PRL1a, PRL2a, and PRL3a is 20.00 inches (508.0 mm). PRL4 standard widths are 24.00, 36.00, and 44.00 inches (609.6, 914.4, and 1117.6 mm).

Procedure for identifying renewal parts

1. Identify the type of panelboard, i.e., PRL1a, PRL2a, PRL3a, PRL4, PRL5P by reading the nameplate. Follow the procedure listed to the left.
2. Refer to the listing below and turn to the proper section in this document to identify standard parts.

Description

Page

PRL1a and PRL2a	4
Trim locks	18
Trim clamps	18
PRL3a	19
PRL4	23
Special trims and enclosures	29
PRL5P	31
PRL1a-LX and PRL2a-LX (column width)	35
Pow-R-Command	35

3. This book identifies those replacement parts most frequently ordered and which are readily available from stock. These parts can be ordered by style or catalog number to speed up processing and delivery.

Distributor ordering instructions

1. Specify part by style/part number.
2. Refer to PL01400001E for pricing information. Discount Symbol CE9 applies.
3. Turn to **page 3** to locate nearest satellite plant.
4. Enter the order on the satellite plant via mail, fax, or phone.
5. Selling policy 25-000 applies.

⚠ WARNING

HAZARDOUS VOLTAGE WILL CAUSE SEVERE INJURY OR DEATH. TURN OFF POWER SUPPLY TO EQUIPMENT BEFORE WORKING ON IT.

Eaton satellite plants

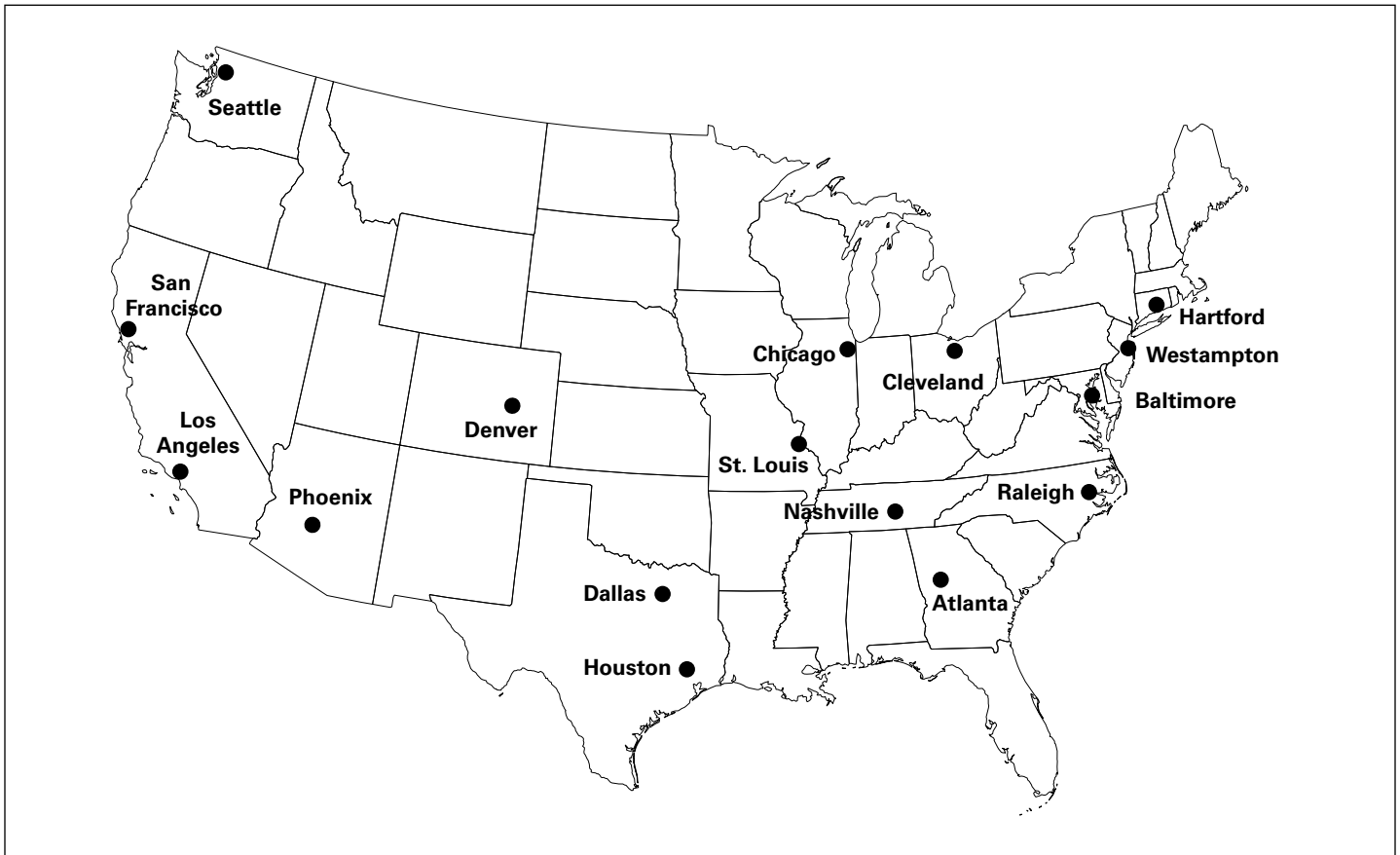

Figure 2. Satellite plants

Atlanta
 7000 Highlands Parkway SE
 Suite 102
 Smyrna, GA 30082
 678.309.4260

Baltimore
 7451 Coca Cola Drive
 Suite C
 Hanover, MD 21076
 410.796.7777

Chicago
 230 Windy Point Drive
 Glendale Heights, IL 60139
 630.260.6303

Cleveland
 12875 Corporate Drive
 Unit E
 Parma, OH 44130
 216.265.3284

Dallas
 631 Westport Parkway
 Suite 100
 Grapevine, TX 76051
 817.251.6733

Denver
 2450 Airport Road
 Suite C
 Aurora, CO 80011
 303.366.2080

Hartford
 40A International Drive
 Windsor, CT 06095
 860.298.1305

Houston
 14825 Northwest Freeway
 Suite 100
 Houston, TX 77040
 713.744.7530

Los Angeles–P&S
 13201 Dahlia Street
 Suite 300
 Fontana, CA 92337
 919.428.8903

Nashville
 1421 Gould Boulevard
 Suite C
 La Vergne, TN 37086
 615.287.3200

Phoenix
 560 N 54th Street
 Suite 1
 Chandler, AZ 85226
 480.449.4222

Raleigh
 9400 Globe Center Drive
 Suite 121
 Morrisville, NC 27560
 919.544.7074

St. Louis
 56 Soccer Park Road
 Fenton, MO 63026
 636.717.3500

San Francisco
 20923 Cabot Boulevard
 Hayward, CA 94545
 510.784.8981

Seattle
 1604 15th Street SW
 Suite 114
 Auburn, WA 98001
 253.833.5021

Westampton
 96 Stemmers Lane
 Westampton, NJ 08060
 609.835.4230

PRL1a, 2a parts section

Description	Page
Connector kits, vertical breakers	4
Connector kits, lug assemblies	5–7
Connector kits, horizontally mounted	8–10
Neutral assemblies	11–14
Ground assemblies	15
Service entrance bonding jumper kits.	15
Service entrance main breaker kits.	15
Deadfront covers.	16–17
Panelboard special trim locks	18
Panelboard EZ trim locks.	18
Panelboard Fastrim clamps and screw-on hardware kits	18

PRL1a, 2a connector kits

Table 2. Vertical breaker assemblies

Device type ①	Device mounting	Three-phase		Single-phase	
		Tin-plated aluminum connector	Silver-plated copper connector	Tin-plated aluminum connector	Silver-plated copper connector
		Catalog number			
F-Frame ② (100 A maximum)	Top fed	KB13AFT	KB13SFT	KB11AFT	KB11SFT
	Bottom fed	KB13AFB	KB13SFB	KB11AFB	KB11SFB
F-Frame ③ (225 A maximum)	Top fed	KB23AFT	KB23SFT	KB21AFT	KB21SFT
	Bottom fed	KB23AFB	KB23SFB	KB21AFB	KB21SFB
J-Frame	Top fed	KB43AJT	KB43SJT	KB41AJT	KB41SJT
	Bottom fed	KB43AJB	KB43SJB	KB41AJB	KB41SJB
K-Frame	Top fed	KB43AKT	KB43SKT	KB41AKT	KB41SKT
	Bottom fed	KB43AKB	KB43SKB	KB41AKB	KB41SKB

① Order main or sub-feed breaker separately when ordering above connector kits.

② EHD, FD, HFD, FDC.

③ FD, HFD, FDC, ED, EDH, EDC.

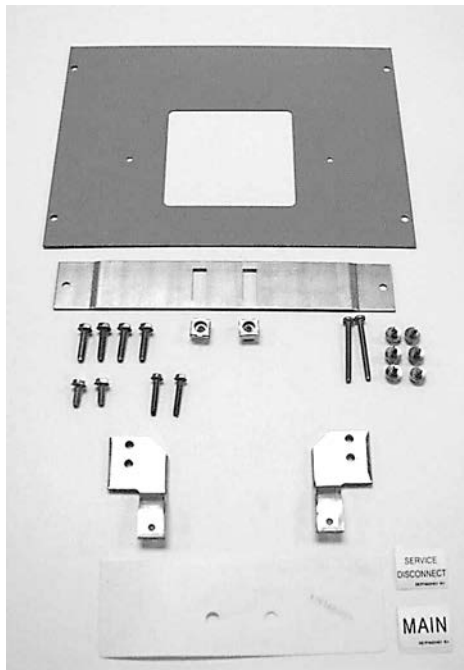

KB11AFT

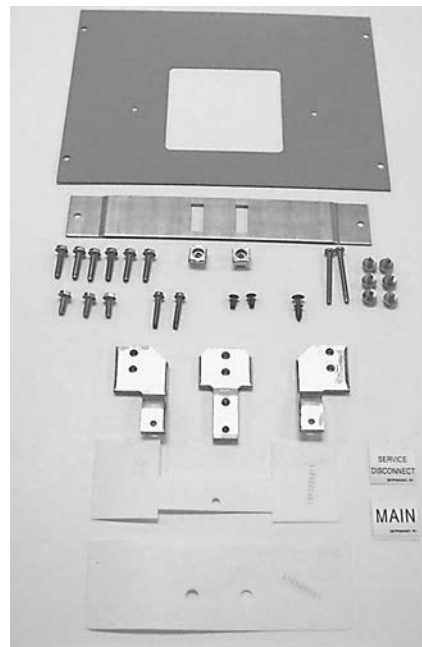

KB13AFT

Table 3. 100 A lug assemblies

Lug type	Panel lug options ①	Wire size range	Quantity per phase	Three-phase		Single-phase	
				Tin-plated aluminum connector Catalog number	Silver-plated copper connector	Tin-plated aluminum connector	Silver-plated copper connector
Aluminum/copper mechanical	STD	#14-1/0	1	KL13AMS	KL13SMS	KL11AMS	KL11SMS
	SFL	#14-1/0	2	KL13AMF	KL13SMF	KL11AMF	KL11SMF
	OVS	#6-300 kcmil	1	KL13AMO	KL13SMO	KL11AMO	KL11SMO
Crimp	STD	#1-1/0	1	KL13AVS	KL13SVS	KL11AVS	KL11SVS
	SFL	#1-1/0	2	KL13AVF	KL13SVF	KL11AVF	KL11SVF
	OVS	2/0-300 kcmil	1	KL13AVO	KL13SVO	KL11AVO	KL11SVO
Copper mechanical	STD	#14-1/0	1	—	KL13SCS	—	KL11SCS
	SFL	#14-1/0	2	—	KL13SCF	—	KL11SCF
	OVS	#6-250 kcmil	1	—	KL13SCO	—	KL11SCO

① STD = Standard lugs. Use for main or through-feed.
 SFL = Sub-feed lugs.
 OVS = Oversize lugs. Use for main or through-feed.



KL13AMS



KL11AVS

Table 4. 225 A lug assemblies

Lug type	Panel lug options ①	Wire size range	Quantity per phase	Three-phase		Single-phase	
				Tin-plated aluminum connector Catalog number	Silver-plated copper connector	Tin-plated aluminum connector	Silver-plated copper connector
Aluminum/copper mechanical	STD	#6–300 kcmil	1	KL23AMS	KL23SMS	KL21AMS	KL21SMS
	SFL	#6–300 kcmil	2	KL23AMF	KL23SMF	KL21AMF	KL21SMF
	OVS	4/0–500 kcmil	1	KL23AMO	KL23SMO	KL21AMO	KL21SMO
Crimp	STD	2/0–300 kcmil	1	KL23AVS	KL23SVS	KL21AVS	KL21SVS
	SFL	2/0–300 kcmil	2	KL23AVF	KL23SVF	KL21AVF	KL21SVF
	OVS	4/0–500 kcmil	1	KL23AVO	KL23SVO	KL21AVO	KL21SVO
Copper mechanical	STD	#6–250 kcmil	1	—	KL23SCS	—	KL21SCS
	SFL	#6–250 kcmil	2	—	KL23SCF	—	KL21SCF
	OVS	1/0–600 kcmil	1	—	KL23SCO	—	KL21SCO

① STD = Standard lugs. Use for main or through-feed.
 SFL = Sub-feed lugs.
 OVS = Oversize lugs. Use for main or through-feed.



KL23AMS



KL21AVS

Table 5. 400 A lug assemblies

Lug type	Panel lug options ①	Wire size range	Quantity per phase	Three-phase		Single-phase	
				Tin-plated aluminum connector Catalog number	Silver-plated copper connector	Tin-plated aluminum connector	Silver-plated copper connector
Aluminum/copper mechanical	STD	4/0–500 kcmil	2	KL43AMS	KL43SMS	KL41AMS	KL41SMS
	SFL	—	—	—	—	—	—
	OVS	3/0–750 kcmil	2	KL43AMO	KL43SMO	KL41AMO	KL41SMO
Crimp	STD	4/0–500 kcmil	2	KL43AVS	KL43SVS	KL41AVS	KL41SVS
	SFL	—	—	—	—	—	—
	OVS	500–750 kcmil	2	KL43AVO	KL43SVO	KL41AVO	KL41SVO
Copper mechanical	STD	1/0–600 kcmil	1	—	—	—	—
	SFL	—	—	—	—	—	—
	OVS	1/0–600 kcmil	1	—	KL43SCO	—	KL41SCO

① STD = Standard lugs. Use for main or through-feed.
 SFL = Sub-feed lugs.
 OVS = Oversize lugs. Use for main or through-feed.

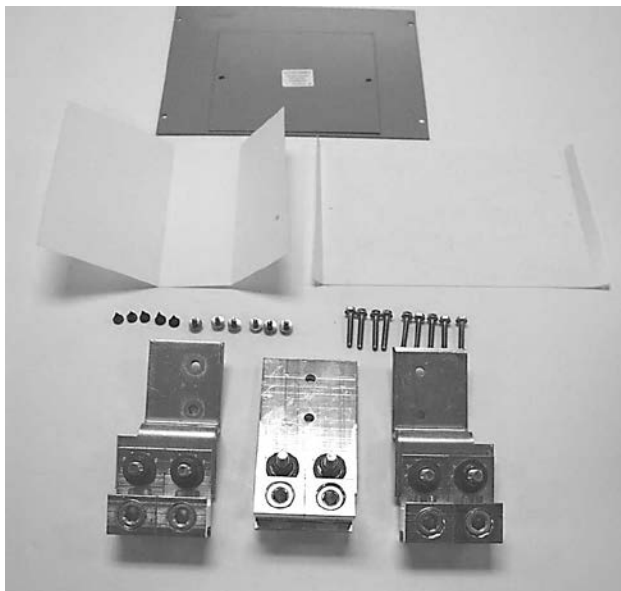

KL43AMS

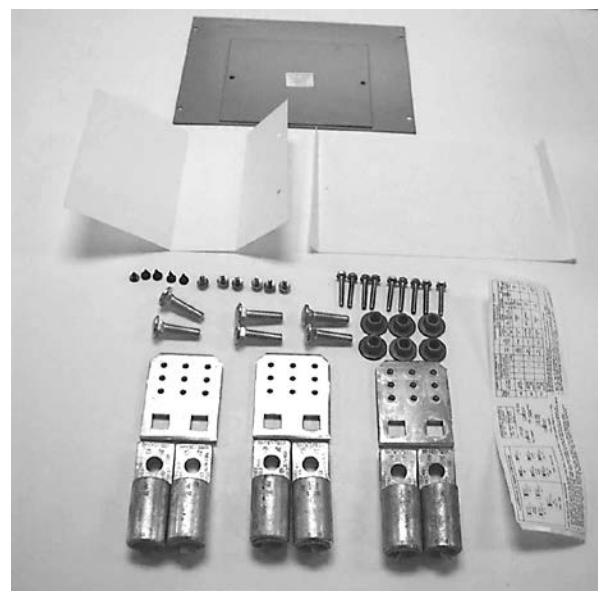

KL43AVS

Table 6. 600 A lug assemblies

Lug type	Panel lug options ①	Wire size range	Quantity per phase	Three-phase connectors			Single-phase connectors				
				Tin-plated aluminum Catalog number	Bare copper	Silver-plated copper	Tin-plated copper	Tin-plated aluminum	Bare copper	Silver-plated copper	Tin-plated copper
Aluminum/copper mechanical	STD	4/0–500 kcmil	2	—	KL63CMS	KL63SMS	KL63TMS	—	KL61CMS	KL61SMS	KL61TMS
	SFL	—	—	—	—	—	—	—	—	—	—
	OVS	3/0–750 kcmil	2	—	KL63CMO	KL63SMO	KL63TMO	—	KL61CMO	KL61SMO	KL61TMO
Crimp	STD	4/0–500 kcmil	2	—	KL63CVS	KL63SVS	KL63TVS	—	KL61CVS	KL61SVS	KL61TVS
	SFL	—	—	—	—	—	—	—	—	—	—
	OVS	500–750 kcmil	2	—	KL63CVO	KL63SVO	KL63TVO	—	KL61CVO	KL61SVO	KL61TVO
Copper mechanical	STD	1/0–600 kcmil	1	—	—	—	—	—	—	—	—
	SFL	—	—	—	—	—	—	—	—	—	—
	OVS	1/0–600 kcmil	1	—	—	—	—	—	—	—	—

① STD = Standard lugs. Use for main or through-feed.
 SFL = Sub-feed lugs.
 OVS = Oversize lugs. Use for main or through-feed.

PRL1a horizontally mounted connector kit assemblies

Table 7. Bolt-on QUICKLAG® breaker assemblies

Breaker frame	Drawing number ①	Branch circuit quantity	Three-phase		Single-phase	
			Tin-plated aluminum connector Item number	Silver-plated copper connector	Tin-plated aluminum connector	Silver-plated copper connector
BA, BAB, QBH, QBGF, QBHGF, QBGFEP, QBHGFEP	1C96608	12	G01	G03	G05	G07
		18	G09	G11	G13	G15
		30	G17	G19	G21	G23
		42	G25	G27	G29	G31
		48	G33	G35	G37	G39
		54	G41	G43	G45	G47
		72	G49	G51	G53	G55
		96	G57	G59	G61	G63

① Order the basic drawing number, along with the equivalent G-number that's needed.

Note: When determining branch circuit quantity, remember:

1. QUICKLAG breakers with shunt trips require one additional circuit.
2. UL® listed lighting and appliance (CTL) panelboards **cannot** exceed 42 electrically connected circuits in a single enclosure.
3. When bare copper is specified, use the silver-plated groups.
4. **Order breakers separately with connector kit.**

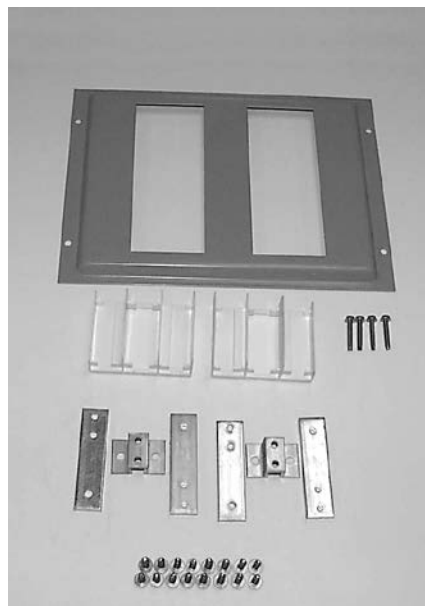

1C96608G01

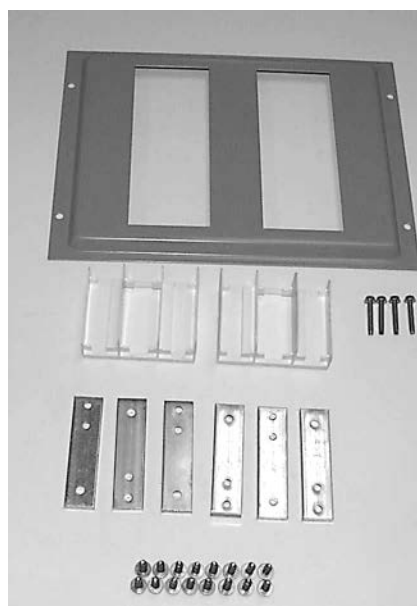

1C96608G05

Table 8. Plug-in QUICKLAG breaker assemblies

Breaker frame	Drawing number ①	Branch circuit quantity	Three-phase		Single-phase	
			Tin-plated aluminum connector	Silver-plated copper connector	Tin-plated aluminum connector	Silver-plated copper connector
			Item number			
HQP, QPHW, QHPX, QPGF, QPHGF, QPGFEP, QPHGFEP	2C11642	12	—	G03	—	G07
		18	—	G11	—	G15
		30	—	G19	—	G23
		42	—	G27	—	G31
		48	—	G35	—	G39
		54	—	G43	—	G47
		72	—	G51	—	G55
		96	—	G59	—	G63

① Order the basic drawing number, along with the equivalent G-number that's needed.

Note: When determining branch circuit quantity, remember:

1. QUICKLAG breakers with shunt trips require one additional circuit.
2. UL listed lighting and appliance (CTL) panelboards **cannot** exceed 42 electrically connected circuits in a single enclosure.
3. When aluminum is specified, use the silver-plated groups.
4. The sum of the horizontally twin-mounted breakers **shall not exceed 140 A**.
5. **Order breakers separately with connector kit.**

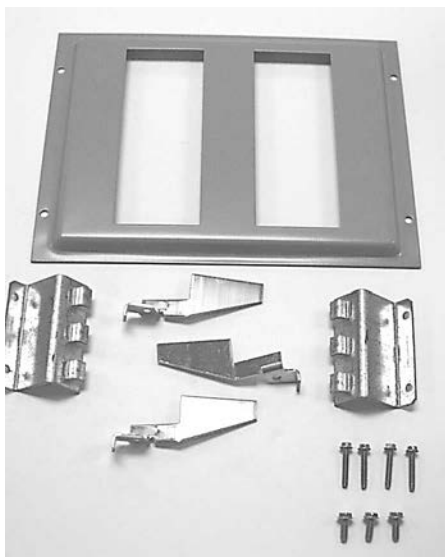

2C11642G03

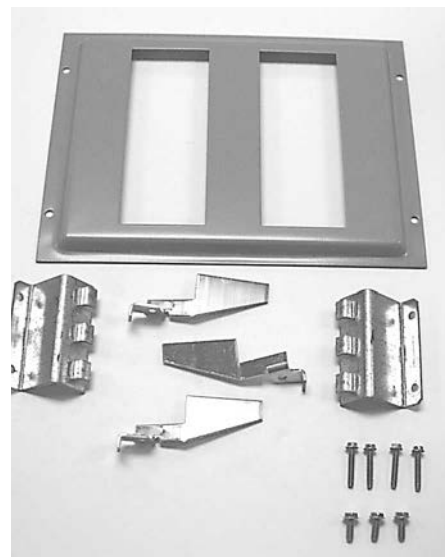

2C11642G07

Effective October 2017

Table 9. GB, GHB, GHQ, GHBS breaker assemblies

Breaker frame	Drawing number ①	Branch circuit quantity	Three-phase		Single-phase	
			Tin-plated aluminum connector Item number	Silver-plated copper connector	Tin-plated aluminum connector	Silver-plated copper connector
GB, GHB, GHQ, GHBS	1C96609	12	G01	G03	G05	G07
		18	G09	G11	G13	G15
		30	G17	G19	G21	G23
		42	G25	G27	G29	G31
		48	G33	G35	G37	G39
		54	G41	G43	G45	G47
		72	G49	G51	G53	G55
		96	G57	G59	G61	G63

① Order the basic drawing number, along with the equivalent G-number that's needed.

Note: When determining branch circuit quantity, remember:

1. QUICKLAG breakers with shunt trips require one additional circuit.
2. UL listed lighting and appliance (CTL) panelboards **cannot** exceed 42 electrically connected circuits in a single enclosure.
3. When bare copper is specified, use the silver-plated groups.
4. **Order breakers separately with connector kit.**

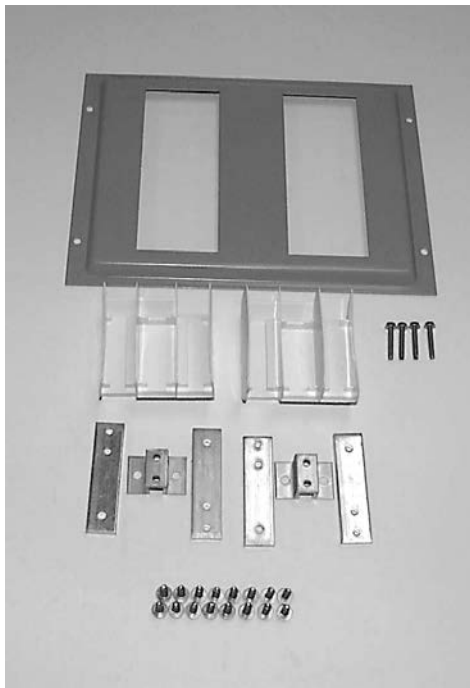

1C96609G01

PRL1a, 2a neutral assemblies

Table 10. 100 A neutral assemblies ①

Panel main bus ampere rating	Neutral rating	Lug type	Drawing number ②	Panel lug options ③	Wire size range	Quantity	Tin-plated aluminum connector Item number	Silver-plated copper connector
100	100%	Mechanical	1C96646	STD	#14-1/0	1	G02	G03
				SFL/TFL	#14-1/0	2	G05	G07
				OVS	#6-300 kcmil	1	G09	G11
		Crimp	42C4050	STD	#1-1/0	1	G01	G03
				SFL/TFL	#1-1/0	2	G05	G07
				OVS	2/0-300 kcmil	1	G09	G11
		Copper	1C96648	STD	#14-1/0	1	—	G03
				SFL/TFL	#14-1/0	2	—	G07
				OVS	#6-250 kcmil	1	—	G11
	200%	Mechanical	1C96649	STD	#6-300 kcmil	1	G02	G03
				SFL/TFL	#6-300 kcmil	2	G06	G07
				OVS	4/0-500 kcmil	1	G09	G11
		Crimp	42C4051	STD	2/0-300 kcmil	1	G01	G03
				SFL/TFL	2/0-300 kcmil	2	G05	G07
				OVS	4/0-500 kcmil	1	G09	G11
Copper	1C96651	STD	#6-250 kcmil	1	—	G03		
		SFL/TFL	#6-250 kcmil	2	—	G07		
		OVS	1/0-600 kcmil	1	—	G11		

① The assemblies shown on this page are for panelboards that mount in 30.00-90.00-inch (762.0-2286.0 mm) high enclosures only. Reference **page 14** for assemblies for panelboards that mount in 21.00-27.00-inch (533.4-685.8 mm) high enclosures.

② Order the basic drawing number, along with the equivalent G-number that's needed.

③ STD = Standard lugs.
SFL/TFL = Sub-feed and through-feed lugs.
OVS = Oversize lugs.



1C96646G01

Effective October 2017

Table 11. 225 A neutral assemblies ①

Panel main bus ampere rating	Neutral rating	Lug type	Drawing number ②	Panel lug options ③	Wire size range	Quantity	Tin-plated aluminum connector Item number	Silver-plated copper connector
225	100%	Mechanical	1C96649	STD	#6–300 kcmil	1	G02	G03
				SFL/TFL	#6–300 kcmil	2	G06	G07
				OVS	4/0–500 kcmil	1	G09	G11
		Crimp	42C4051	STD	2/0–300 kcmil	1	G01	G03
				SFL/TFL	2/0–300 kcmil	2	G05	G07
				OVS	4/0–500 kcmil	1	G09	G11
		Copper	1C96651	STD	#6–250 kcmil	1	—	G03
				SFL/TFL	#6–250 kcmil	2	—	G07
				OVS	1/0–600 kcmil	1	—	G11
	200%	Mechanical	1C96652	STD	4/0–500 kcmil	2	G01	G03
				SFL/TFL	—	—	G05	G07
				OVS	3/0–750 kcmil	2	G09	G11
		Crimp	42C4052	STD	4/0–500 kcmil	2	G01	G03
				SFL/TFL	—	—	G05	G07
				OVS	500–750 kcmil	2	G09	G11
		Copper	1C96654	STD	1/0–600 kcmil	1	—	G03
				SFL/TFL	—	—	—	G07
				OVS	1/0–600 kcmil	1	—	G11

① The assemblies shown on this page are for panelboards that mount in 30.00–90.00-inch (762.0–2286.0 mm) high enclosures.

② Order the basic drawing number, along with the equivalent G-number that's needed.

③ STD = Standard lugs.
SFL/TFL = Sub-feed and through-feed lugs.
OVS = Oversize lugs.



1C96649G01

Table 12. 400 A neutral assemblies ①

Panel main bus ampere rating	Neutral rating	Lug type	Drawing number ②	Panel lug options ③	Wire size range	Quantity	Tin-plated aluminum connector	Silver-plated copper connector
							Item number	
400	100%	Mechanical	1C96652	STD	4/0–500 kcmil	2	G01	G03
				SFL/TFL	—	—	G05	G07
				OVS	3/0–750 kcmil	2	G09	G11
		Crimp	42C4052	STD	4/0–500 kcmil	2	G01	G03
				SFL/TFL	—	—	G05	G07
				OVS	500–750 kcmil	2	G09	G11
		Copper	1C96654	STD	1/0–600 kcmil	1	—	G03
				SFL/TFL	—	—	—	G07
				OVS	1/0–600 kcmil	1	—	G11

① The assemblies shown on this page are for panelboards that mount in 30.00–90.00-inch (762.0–2286.0 mm) high enclosures.

② Order the basic drawing number, along with the equivalent G-number that's needed.

③ STD = Standard lugs.
SFL/TFL = Sub-feed and through-feed lugs.
OVS = Oversize lugs.

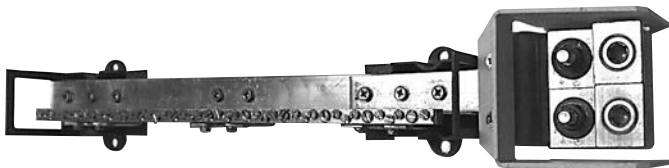

1C96652G01

Table 13. 600 A neutral assemblies ①

Panel main bus ampere rating	Neutral rating	Lug type	Drawing number ②	Circuit quantity	Panel lug options ③	Tin-plated aluminum connector	Bare copper	Silver-plated copper connector	Tin-plated copper connector
						Item number			
600	100%	Mechanical	1C96652	42 or less	STD	—	G02	G03	G04
					TFL	—	G06	G07	G08
					OVS	—	G10	G11	G12
					OVS W/ TFL	—	G26	G27	G28
		Anderson	—	42 or less	STD	—	—	—	—
					TFL	—	—	—	
					OVS	—	—	—	
		Burndy	42C4052	42 or less	STD	—	G02	G03	G04
					TFL	—	G06	G07	G08
					OVS	—	G10	G11	G12
		Copper	—	42 or less	STD	—	—	—	—
					TFL	—	—	—	
					OVS	—	—	—	
					Greater than 42	STD	—	—	—
						TFL	—	—	—
OVS	—					—	—		

① The assemblies shown on this page are for panelboards that mount in 30.00–90.00-inch (762.0–2286.0 mm) high enclosures.

② Order the basic drawing number, along with the equivalent G-number that's needed.

③ STD = Standard lugs.
SFL/TFL = Sub-feed and through-feed lugs.
OVS = Oversize lugs.

Effective October 2017

Table 14. 100 A neutral assemblies for 21.00–27.00-inch (533.4–685.8 mm) high enclosures only ①

Panel main bus ampere rating	Neutral rating	Lug type	Drawing number ②	Panel lug options ③	Wire size range	Quantity	Tin-plated aluminum connector	Silver-plated copper connector	
							Item number		
100	100%	Mechanical	1C96645	STD	#14–1/0	1	G01	G03	
				SFL/TFL	#14–1/0	2	G05	G07	
				OVS	—	—	—	—	
		Crimp	—	STD	—	—	—	—	—
			SFL/TFL	—	—	—	—	—	—
			OVS	—	—	—	—	—	—
	Copper	—	STD	—	—	—	—	—	
		SFL/TFL	—	—	—	—	—	—	
		OVS	—	—	—	—	—	—	
	200%	Mechanical	1C97022	STD	#6–300 kcmil	1	G01	G03	
				SFL/TFL	#6–300 kcmil	2	G05	G07	
				OVS	—	—	—	—	
Crimp		—	STD	—	—	—	—	—	
		SFL/TFL	—	—	—	—	—	—	
		OVS	—	—	—	—	—	—	
Copper		—	STD	—	—	—	—	—	
		SFL/TFL	—	—	—	—	—	—	
		OVS	—	—	—	—	—	—	

① The assemblies shown on this page are for panelboards that mount in 21.00–27.00-inch (533.4–685.8 mm) high enclosures only. Reference **page 11** for assemblies for panels that mount in 36.00, 48.00, 60.00, 72.00, and 90.00-inch (914.4, 1219.2, 1524.0, 1828.8, and 2286.0 mm) high enclosures.

② Order the basic drawing number, along with the equivalent G-number that's needed.

③ STD = Standard lugs.
SFL/TFL = Sub-feed and through-feed lugs.
OVS = Oversize lugs.



1C96645G01

PRL1a, 2a ground assemblies

Table 15. Standard ground

Drawing number ①	Enclosure height in inches (mm)	Bar material	Item number
5158C05	24.00 (609.6)	Aluminum/copper	G01
		Copper	G03
	36.00 (914.4), 48.00 (1219.2), 60.00 (1524.0), 72.00 (1828.8), 90.00 (2286.0)	Aluminum/copper	G02
		Copper	G04

① Order the basic drawing number, along with the equivalent G-number that's needed (example: 5158C05G01).



5158C05G01



5158C05G02

Table 16. Isolated ground

Drawing number ①	Enclosure height in inches (mm)	Bar material	Item number
2C11296	24.00 (609.6)	Aluminum/copper	G01
		Copper	G02
	36.00 (914.4), 48.00 (1219.2), 60.00 (1524.0), 72.00 (1828.8), 90.00 (2286.0)	Aluminum/copper	G03
		Copper	G04

① Order the basic drawing number, along with the equivalent G-number that's needed (example: 5158C05G01).

PRL1a, 2a service entrance bonding jumper kits

Table 17. PRL1a, 2a service entrance bonding jumper kits

Drawing number ①	Panel ampere rating	Tin-plated aluminum	Bare copper	Silver-plated copper	Tin-plated copper
Mechanical main lugs or main breakers					
4180B62	100–225	G01	G02	G03	G04
4180B62	400–600	G05	G06	G07	G08
Compression (crimp) main lugs					
4180B62	100–225	G09	G10	G11	G12
4180B62	400–600	G13	G14	G15	G16
Copper main lugs					
4180B62	100–225	—	G18	G19	G20
4180B62	400–600	—	G22	G23	G24

① Order the basic drawing number, along with the equivalent G-number that's needed (example: 5158C05G01).



4180B62G01

PRL1a, 2a service entrance main breaker kits

Table 18. PRL1a, 2a service entrance main breaker kits

Description	Circuit breaker frame	Catalog number
Service entrance barrier for LG and KD	LG/KD	PRLSEBLGKD
Service entrance barrier for JD	JD	PRLSEBJD
Service entrance barrier for FD	FD	PRLSEBFD
Service entrance barrier for GHB	GHB	PRLSEBGB



SE barrier kit FD_016

Effective October 2017

PRL1a, 2a deadfront covers

Note: Does not apply to PRL4 sub-chassis.

Table 19. Assembly

Assembly drawing number ①	Standard enclosure height in inches (mm)						
	24.00 (609.6)	36.00 (914.4)	42.00 (1066.8)	48.00 (1219.2)	60.00 (1524.0)	72.00 (1828.8)	90.00 (2286.0)
1C96638	G01	G02	G07	G03	G04	G05	G06

① Order the basic drawing number, along with the equivalent G-number that's needed (example: 1C96638G01).



1C96638G01

Table 20. Vertically mounted devices

Mounting arrangement	Device/frame	Drawing number ①	Mounting position	Item number
Vertical	100 A MLO, SFL, TFL or F-Frame (100 A maximum)	4180B03	Top	H01
			Bottom	H01
	225 A MLO, SFL, TFL or F-Frame (225 A maximum)	4180B61	Top	H01
			Bottom	H01
	400 A MLO, SFL, TFL or J-Frame	4180B04	Top	H01
			Bottom	H02
	400 A MLO, TFL or K-Frame	4180B05	Top	H01
			Bottom	H02
Blank covers in inches (mm)	1.00 (25.4)	4180B08	—	H01
	2.00 (50.8)		—	H02
	3.00 (76.2)		—	H03
	4.00 (101.6)		—	H04
	5.00 (127.0)		—	H05
	6.00 (152.4)		—	H06
	7.00 (177.8)		—	H07
	8.00 (203.2)		—	H08
	9.00 (228.6)		—	H09
	10.00 (254.0)		—	H10
	11.00 (279.4)		—	H11
	12.00 (304.8)		—	H12
	13.00 (330.2)		—	H13
	14.00 (355.6)		—	H14
	15.00 (381.0)		—	H15
	16.00 (406.4)		—	H16

① Order the basic drawing number, along with the equivalent H-number that's needed (example: 4180B03H01).



4180B08H03

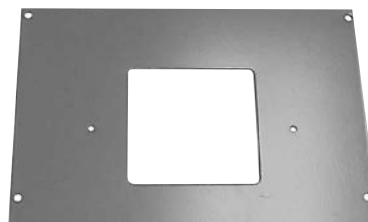

4180B03H01

Table 21. Horizontally mounted devices

Mounting arrangement	Device/frame	Drawing number ①	Branch circuit quantity	Item number	Quantity required			
Horizontal	BA, BAB, QBH, QBGF, QBHGF, QBGFEP, QBHGFEP	1C96619	12	H01	1			
			18	H02	1			
			30	H04	1			
			42	H06	1			
			48	H03	2			
			54	H03 and H04	1 each			
			72	H05	2			
			96	H07	2			
			Horizontal	GB, GHB, GHQ, GHBS	1C96620	12	H01	1
						18	H02	1
						30	H04	1
						42	H06	1
						48	H03	2
						54	H03 and H04	1 each
72	H05	2						
96	H07	2						

① Order the basic drawing number, along with the equivalent H-number that's needed (example: 1C96619H01).

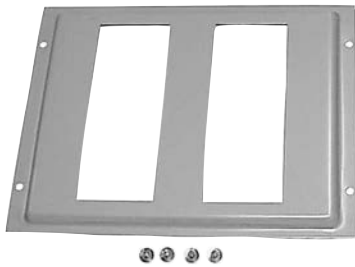

1C96619H01



1C96620H01

Table 22. Filler covers

Device/frame	Drawing number	Item number
F, J, K ①	4180B52	H01
QUICKLAG, GB, GHB ②	5155C62	H01

① Filler covers are required in addition to deadfront cover whenever MLO, SFL or TFL are specified.

② Filler covers are required in addition to deadfront cover whenever a branch provision is specified.

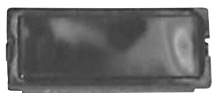

5155C62H01



4180B52H01

Panelboard special trim locks

Panelboard trims use different trim locks. See pictures below for styles and part numbers. Contact your nearest satellite for availability on the styles listed below. See **page 3** for satellite listings.

Table 23. Panelboard special trim locks

Description	Catalog number
For use on left-handed door (hinged on left side)	K80522
For use on right-handed door (hinged on right side)	K80133
T-Handle lock, at one time used on all trims over 48.00 inches (1219.2 mm) in height Also used on outdoor NEMA® 12/3R trims	K80429
Used on PRL4 lighting and power panels as standard	1A32258H03
Used on PRL1, 2, 3 and PRL1a, 2a, 3a lighting panels as standard; WEM 2 key	5155C81G01

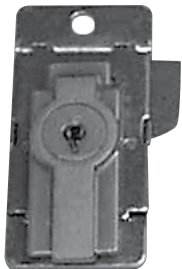

K80522

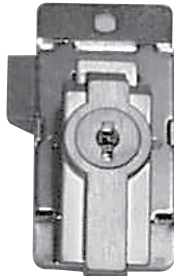

K80133



5155C81G01

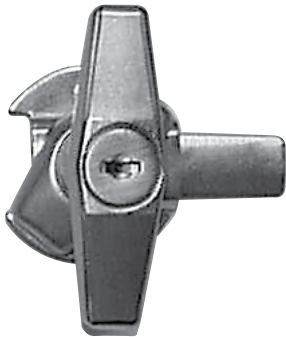

K80429

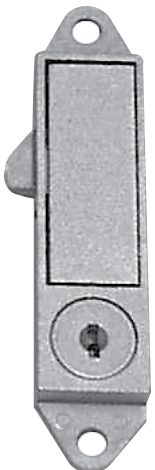

1A32258H03

Panelboard EZ trim locks

Panelboard EZ trims use different trim locks. See **Table 24** and pictures below for styles and part numbers. Contact your nearest satellite for availability. See **page 3** for satellite listings.

Table 24. Panelboard EZ trim locks

Description	Size	Catalog number
Lock	24–48 inches	5155C81G03
Lock and latch	54–60 inches	5155C81G03/5155C81G05
Lock and latch	72–90 inches	5155C81G04/5155C81G06



EZ trim lock with key



EZ trim latch without key

Panelboard Fastrim clamps and screw-on hardware kits

For panelboard trim clamps, contact your nearest satellite for availability on the styles listed below. See **page 3** for satellite listings.

Table 25. Panelboard Fastrim clamps and screw-on hardware kits

Description	Style number
Trim clamps—used on PRL1a, 2a, 3a Fastrims (6 per bag)	2C11641G02
Trim screws—used on PRL1a, 2a, 3a, 4B standard trim (10 per bag)	5157C83G06
Chassis mounting hardware bag—PRL1a, 2a, 3a panels	7499A48G04

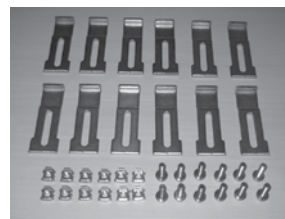

2C11641G02



5157C83G06



7499A48G04

PRL3a parts section

Description	Page
Connector kit assemblies	19
Ground assemblies	20
Service entrance kits	20
Deadfront covers	20–22

PRL3a horizontally mounted connector kit assemblies

Three-phase kits contain A, B, and C phase connectors. Single-phase kits contain A and C phase connectors, deadfront cover, hardware and instructions to twin-mount breakers across from each other. **Maximum amperes connected to any one connector cannot exceed 200 A.**

Table 26. Connector kit assemblies

Devices	Circuits or pole	Three-phase		Single-phase		Notes
		Catalog number	Phase	Catalog number	Phase	
BA, BAB, QBGF, QBH, QBHGF, QBGFEP, QBHGFEP	6	KPRL3ABA06	A/B/C	KPRL3ABA06-1	A/C	(2) 100 A devices maximum
	12	KPRL3ABA12	A/B/C	KPRL3ABA12-1	A/C	
	18	KPRL3ABA18	A/B/C	KPRL3ABA18-1	A/C	
	24	KPRL3ABA24	A/B/C	KPRL3ABA24-1	A/C	
GB, GHB, GHQ, GHBS	6	KPRL3AGB06	A/B/C	KPRL3AGB06-1	A/C	
	12	KPRL3AGB12	A/B/C	KPRL3AGB12-1	A/C	
	18	KPRL3AGB18	A/B/C	KPRL3AGB18-1	A/C	
	24	KPRL3AGB24	A/B/C	KPRL3AGB24-1	A/C	

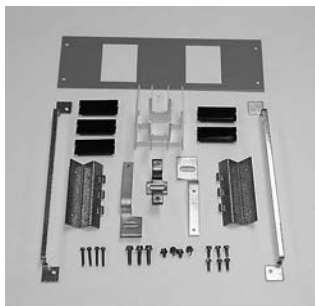

KPRL3ABA06

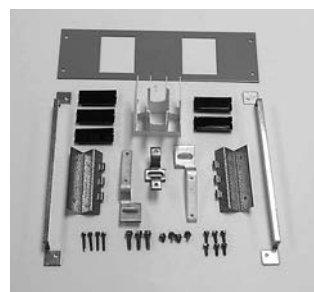

KPRL3AGB06

PRL3a F-Frame horizontally mounted connector kit assemblies

Connector kits contain phase connectors, deadfront cover, hardware, and instructions to mount breakers. Order breakers separately when ordering connector kit.

Table 27. Connector kit assemblies

Devices	Circuits or pole	Three-phase		Single-phase		Notes
		Catalog number	Phase	Catalog number	Phase	
EHD, FD, FDB, HFD, FDC (150 A maximum twin mount)	Three-pole breaker	KPRL3AFD3	A/B/C	—	—	(2) 150 A devices maximum
	Two-pole breaker	KPRL3AFD2	A/C	KPRL3AFD2	A/C	
	Single-pole breaker	KPRL3AFD1	A/C	KPRL3AFD1	A/C	
FD, HFD, FDC, ED, EDH, EDC (175–225 A single mount) Ⓞ	Three-pole breaker	KPRL3AED3	A/B/C	—	—	(1) 225 A maximum single mounted
	Two-pole breaker	KPRL3AED2	A/C	KPRL3AED2	A/C	

Ⓞ F-Frame devices rated above 150 A must be single mounted. No twin mounting acceptable.

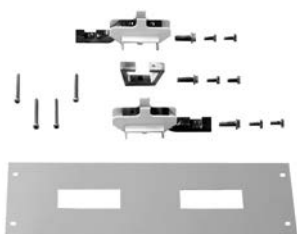

KPRL3AFD3

PRL3a ground assemblies

Table 28. PRL3a ground assemblies

Material	Standard	Isolated
	Catalog number	
Aluminum/copper	5158C05G02	2C11296G02
Copper only	5158C05G04	2C11296G04



5158C05G02

PRL3a service entrance bonding jumper kits

Table 29. PRL3a service entrance bonding jumper kits

Style number ①	Panel ampere rating	Tin-plated aluminum	Bare copper	Silver-plated copper	Tin-plated copper
		Item number			
Mechanical main lugs or main breakers					
5078A98	100	G01	G02	G03	G04
	250–600	G13	G14	G15	G16
Crimp main lugs					
5078A98	100	G05	G06	G07	G08
	250–600	G17	G18	G19	G20
Copper main lugs					
5078A98	100	G09	G10	G11	G12
	250–600	G21	G22	G23	G24

① When ordering, use complete style number (example: 100 A tin-plated aluminum 5078A98G01).



5078A98G01

PRL3a service entrance main breaker kits

Table 30. PRL3a service entrance main breaker kits

Description	Circuit breaker frame	Catalog number
Service entrance barrier for LG and KD	LG/KD	PRLSEBLGKD
Service entrance barrier for JD	JD	PRLSEBJD
Service entrance barrier for FD	FD	PRLSEBFD
Service entrance barrier for GHB	GHB	PRLSEBGHB



SE Barrier Kit FD_016

PRL3a deadfront covers

Table 31. Assembly ①

Style number ②	Chassis height/item number				
	14X	23X	31X	40X	53X
6559C59	G01	G02	G03	G04	G05

① Assembly groups include the frame only (two rails and two end covers). Reference page 22 for specific device covers. All connector kits ship with a deadfront cover for that device.

② When ordering, use complete style number (example: 14X high assembly 6559C59G01).



6559C59G01

PRL3a vertical devices deadfront covers**Table 32. Vertical mounting position**

Device/frame	Trip unit type	Style number ①	"X" space required	Item number	
				Without lock-offs ①	With lock-offs ①
EHD, FD, FDB, HFD, FDC, ED, EDH, EDC (top) ②	—	4176B68	7X	H01	H03
EHD, FD, FDB, HFD, FDC, ED, EDH, EDC (bottom) ②	—		7X	H04	H05
FD, HFD, FDC, ED, EDH (top) ③	—	4180B93	10X	H01	H03
FD, HFD, FDC, ED, EDH (bottom) ③	—		10X	H04	H05
J-Frame (bottom)	—	4176B60	14X	H01	H02
J-Frame (top)	—		14X	H03	H04
K-Frame (bottom)	Thermal-mag.	4176B61	15X	H01	H02
K-Frame (bottom)	Electronic		15X	H03	H04
K-Frame (top)	Thermal-mag.		15X	H05	H06
K-Frame (top)	Electronic		15X	H07	H08
L-Frame (bottom)	Thermal-mag.	4176B51	17X	H01	H02
L-Frame (bottom)	Electronic		17X	H03	H04
L-Frame (top)	Thermal-mag.		17X	H05	H06
L-Frame (top)	Electronic		17X	H07	H08
FB-P (top only)	—	4176B70	9X	H02	H02
LA-P (top only)	—	4176B57	21X	H01	H01
FCL	—	4176B70	9X	H01	H01
LCL (top)	—	4176B56	21X	H01	H02
LCL (bottom)	—		21X	H03	H04
Neutral/blank cover	—	4176B72	1X	H01	—
			2X	H02	
			3X	H03	
			4X	H04	
			5X	H05	
			6X	H06	
			7X	H07	
			8X	H08	
			9X	H09	
			10X	H10	
			11X	H11	
			12X	H12	
J-Frame sub-feed twin bottom	—	4176B79	20X	H01	H02 (2 L/O) H03 (1 L/O RT) H04 (1 L/O LT)
J-Frame sub-feed twin top	—	4176B79	20X	H05	H05 (2 L/O) H07 (1 L/O RT) H08 (1 L/O LT)
PT363 (top)	—	4180B79	7X	H01	—
PT363 (bottom)	—		7X	H02	
PT364 (top)	—		9X	H03	
PT364 (bottom)	—		9X	H04	

① When ordering covers, order complete style and item numbers (example: 4176B68H01).

② 4/0 maximum acceptable terminal size.

③ 300 kcmil maximum acceptable terminal size.



J main 4176B60H04



Neutral blank cover 4176B72H04

Effective October 2017

PRL3a horizontal devices deadfront covers**Table 33. Horizontal mounting position**

Device/frame	Device poles	Style number ①	Total circuit quantity	"X" space required	Item number
EHD, FD, FDB, FDC (twin mounted)	1, 2 or 3	4178B08	6	3X	H01
			12	6X	H02
			18	9X	H03
			24	12X	H04
			30	15X	H05
			36	18X	H06
			42	21X	H07
			48	24X	H08
EHD, FD, FDB, HFD, FDC (twin mounted)	1 or 2	4179B39	4	2X	H01
			8	4X	H02
			12	6X	H03
			16	8X	H04
			20	10X	H05
			24	12X	H06
			28	14X	H07
			32	16X	H08
EHD, FD, FDB, HFD, FDC (twin mounted)	1	4179B40	2	1X	H01
FD, HFD, FDC, ED, EDH, EDC (single mounted)	3	4179B41	3	3X	H01
FD, HFD, FDC, ED, EDH, EDC (single mounted)	2	4179B42	2	2X	H01
CA, CAH, HCA	3	4176B66	3	3X	H01
CA, CAH, HCA	2	4176B80	2	2X	H01
BA, BAB, BABRP, BABRSP QBH, QBGF, QBGFEP, QBHGFEP	1, 2 or 3	4176B67	6	3X	H01
			12	5X	H02
			18	8X	H03
			24	10X	H04
GB, GHB, GHBS, GHBGFEF, HGHB, GHQ	1, 2 or 3	4176B69	6	3X	H01
			12	5X	H02
			18	8X	H03
			24	10X	H04
Pow-R-Command Controller	—	4180B91	—	5X	H01
Pow-R-Command Expansion	—	4180B91	—	7X	H02
				16X	H03

① When ordering covers, order complete style and item number (example: 4178B08H01).

PRL3a deadfront cover blank fillers**Table 34. PRL3a deadfront cover blank fillers**

Device/frame	Poles	Style number
F-Frame	1, 2 or 3	4178B06H01
C-Frame	2	6555C40H01
C-Frame	3	6555C41H01
QUICKLAG, GB, GHB, GHBS	1, 2 or 3	5155C62H01



BAB Cover 4176B67H01

PRL4 parts section

Description	Page
Vented cover assemblies	23
Blank covers	24
Breaker connector kits	24
Fusible connector kits	25
Breaker and fusible switch retrofit kits	26–27
PRL1a, 2a, 3a EZ trims and enclosures	27
PRL4 special trims and enclosures	29
Type 12/3R enclosures	30

PRL4 vented cover assemblies

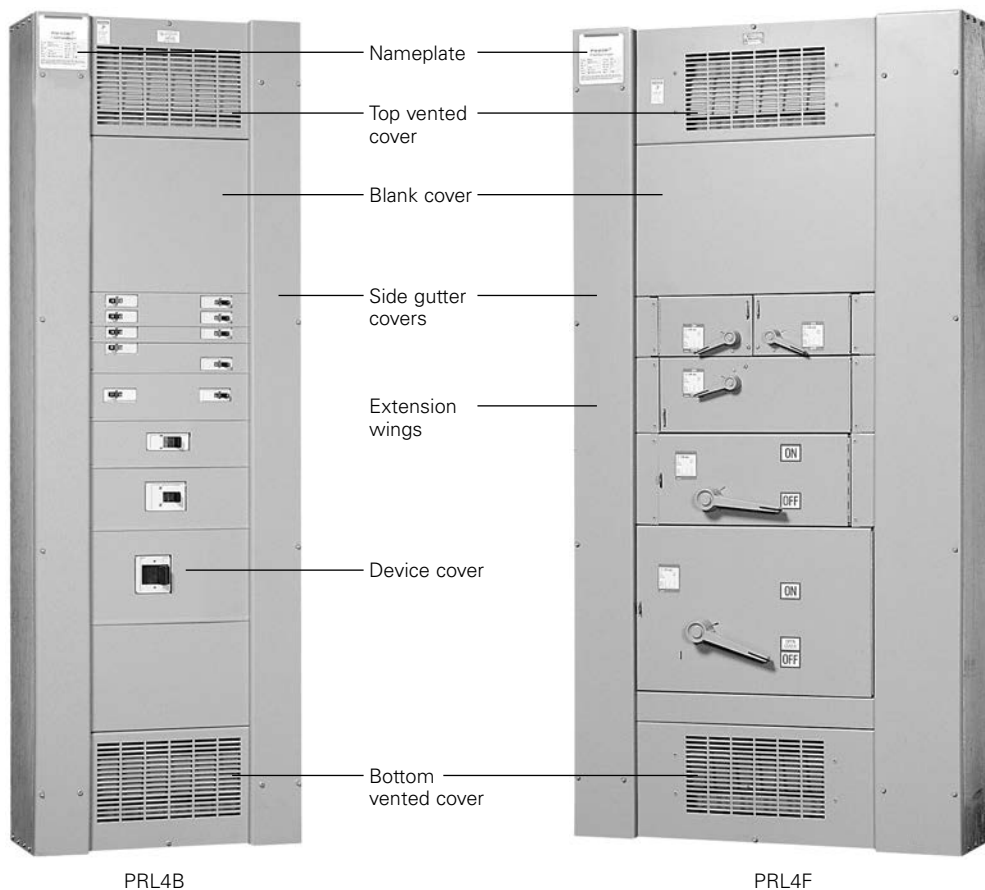

Table 35. Vented cover assemblies and side gutter covers—dimensions in inches (mm)

NEMA 1 box					Side gutter covers			
Height	Width	Depth ①	Catalog number	Vented cover assembly style number ②	Left		Right	
					Size	Style number	Size	Style number
57.00 (1447.8)	24.00 (609.6)	10.40 (264.2)	BX2457	6574C74G02	5.00 (127.0) x 57.00 (1447.8)	6555C20H01	5.00 (127.0) x 57.00 (1447.8)	6555C20H01
73.00 (1854.2)	24.00 (609.6)		BX2473	6574C74G03	5.00 (127.0) x 73.00 (1854.2)	6555C21H01	5.00 (127.0) x 73.00 (1854.2)	6555C21H01
90.00 (2286.0)	24.00 (609.6)		BX2490	6574C74G04	5.00 (127.0) x 90.00 (2286.0)	6555C25H01	5.00 (127.0) x 90.00 (2286.0)	6555C25H01
73.00 (1854.2)	36.00 (914.4)		BX3673	6574C74G05	6.00 (152.4) x 73.00 (1854.2)	6555C22H01	8.00 (203.2) x 73.00 (1854.2)	6555C23H01
90.00 (2286.0)	36.00 (914.4)		BX3690	6574C74G06	6.00 (152.4) x 90.00 (2286.0)	6555C26H01	8.00 (203.2) x 90.00 (2286.0)	6555C27H01
73.00 (1854.2)	44.00 (1117.6)		BX4473	6574C74G05	8.00 (203.2) x 73.00 (1854.2)	6555C23H01	14.00 (355.6) x 73.00 (1854.2)	6555C24H01
90.00 (2286.0)	44.00 (1117.6)		BX4490	6574C74G06	8.00 (203.2) x 90.00 (2286.0)	6555C27H01	14.00 (355.6) x 90.00 (2286.0)	6555C28H01

① Covers add 0.90 inches (22.9 mm) to box depth for overall enclosure depth of 11.30 inches (287.0 mm).

② Cover assembly consists of two side rails, top and bottom vented covers. **Important:** Order individual device covers and blanks separately.

PRL4 blank covers

Used to cover blank space on chassis. All PRL4 cover heights are measured in "X" units. 1X equals 1.38 inches (35.1 mm).

Table 36. PRL4 blank covers

Cover size	Style number	
	24.00-inch (609.6 mm) width box	36.00, 44.00-inch (914.4, 1117.6 mm) width box
1X	6554C01H01	6554C02H01
2X	6554C01H02	6554C02H02
3X	6554C01H03	6554C02H03
4X	6554C01H13	6554C02H13
5X	6554C01H14	6554C02H14
6X	6554C01H04	6554C02H04
7X	6554C01H05	6554C02H05
9X	6554C01H06	6554C02H06
10X	6554C01H07	6554C02H07
11X	6554C01H08	6554C02H08
12X	6554C01H09	6554C02H09
13X	6554C01H10	6554C02H10
15X	6554C01H11	6554C02H11
20X	6554C01H12	6554C02H12

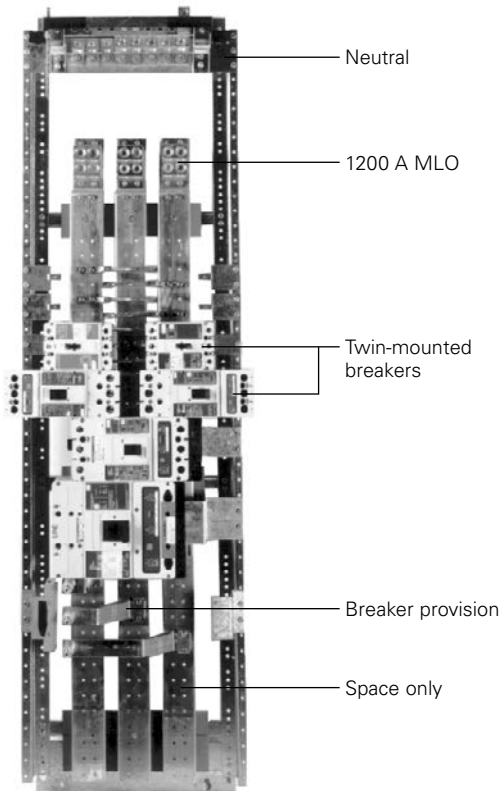

PRL4B Interior

PRL4 breaker connector kits

Breaker connector kits

Each kit includes copper connectors, mounting brackets, covers, hardware, and instructions for mounting breaker(s) in a PRL4.

Breakers are not included. Contact your local satellite plant for availability and application information (see **page 3**).

Connector kit

Each kit includes copper connectors mounting brackets, cover, hardware, and instructions.

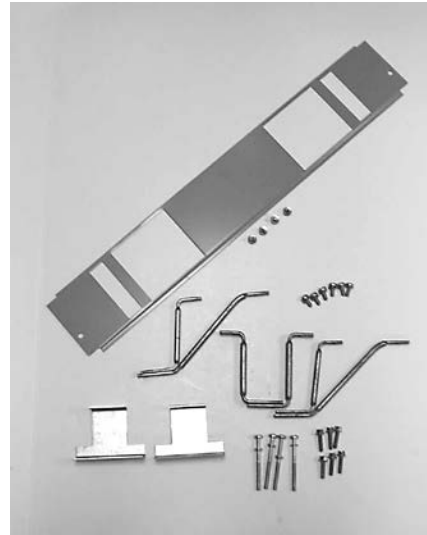

Connector kit

Table 37. Breaker connector kits

Breaker frame	Space required		Poles	Mounting type	Connector kit catalog number
	Inches (mm)	"X"			
EHD, FD, HFD	2.75 (69.9)	2X	1 ①	Twin	KPRL4FD1
EHD, FD, FDB, HFD, FDC			2	Twin	KPRL4FD2
ED, EDH, EDC			2	Twin	KPRL4ED2
EHD, FD, FDB, HFD, FDC	4.13 (104.9)	3X	3	Twin	KPRL4FD
FCL, FB-P, FD/LFD			3	Twin	KPRL4FBP
ED, EDH, EDC			3	Twin	KPRL4ED
JD, JDB, HJD, JDC			2, 3	Single	KPRL4JDS
JD, JDB, HJD, JDC			2, 3	Twin	KPRL4JDT ②
DK, KD, KDB, HKD, KDC	5.50 (139.7)	4X	2, 3	Single	KPRL4KDS
DK, KD, KDB, HKD, KDC			2, 3	Twin	KPRL4KDT ③
CKD, CHKD			2, 3	Single	KPRL4CKD ④
LCL	8.25 (209.5)	6X	2, 3	Single	KPRL4LCL ②
LA-P			2, 3	Single	KPRL4LAP ②
LD, LDB, HLD, LDC, CLD, LC			2, 3	Single	KPRL4LD ②
MDL, HMDL			2, 3	Single	KPRL4MC ②
NB-P			2, 3	Single	KPRL4NBP ③
CND, CHND			3	Single	KPRL4CND ③④
ND, HND			2, 3	Single	KPRL4ND ②

① Two sets of twin-mounted single-pole breakers.

② 36.00-inch (914.4 mm) minimum box width required.

③ 44.00-inch (1117.6 mm) box width required.

④ Requires density rated bus in existing panel chassis.

Hardware kit

Each kit includes mounting bracket(s) and mounting hardware only. Use the appropriate connector kit catalog number and add an “H” to designate hardware only (example: KPRL4FD-H).

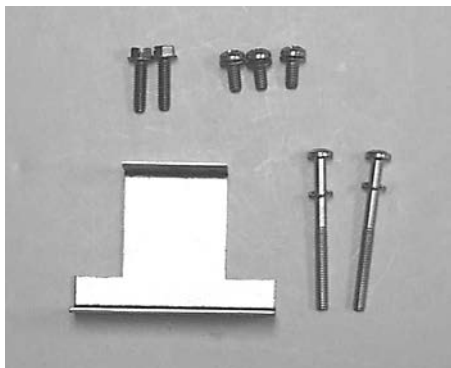

Hardware kit

Standard ground bus

Copper bus with (3) 6–300 kcmil lugs plus a 24-circuit terminal bar with #14–1/0 wire range.

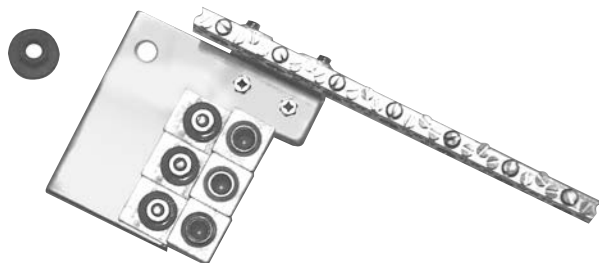

6572C746G01

PRL4 fusible connector kits

Fusible switch connector kits

Each kit includes copper connectors, extension wings (when required), hardware, and instructions to mount a fusible switch. Switches are not included. Contact your local satellite plant for availability and application information (see **page 3**).

Table 38. Fusible switch connector kits

Switch height Inches (mm)	“X” space required	Switch ampere rating	Three-pole switch		Connector kit
			240 V Catalog number	600 V	
5.50 (139.7)	4X	30–30	FDPWT3211R	FDPWT3611R	—
		60–60	FDPWT3222R	FDPWT3622R	KPRL44X ①
		100–100	FDPWT3233R	—	—
6.88 (174.8)	5X	100–100	—	FDPWT3633R	KPRL45X1
8.25 (209.6)	6X	200	FDPBS324R	FDPBS364R	KPRL4B6XS
		200–200	FDPBT3244R	FDPBT3644R	KPRL4B6XT ②
12.38 (314.5)	9X	400	FDPW325R	FDPW365R	KPRL4W9X
15.13 (384.3)	11X	600	FDPW326R	FDPW366R	KPRL4W11X
		800	FDPW327	FDPW367	KPRL4W11X ②
20.63 (524.0)	15X	1200	FDPW328	FDPW368	KPRL4W15X ②

① These connector kits will fit the FDP and FDPW switches.

② 44.00-inch (1117.6 mm) box width required for both R and J fuse applications.

PRL4 breaker and fusible switch retrofit kits

Breaker retrofit kits

Each kit includes one breaker, copper connectors, covers, hardware, and instructions to mount in a PRL4.

Table 39. Breaker retrofit kits

Breaker frame	Frame ampere rating	Trip range	Mounting type
EHD	100	15–100	Twin
FDB		15–100	Twin
FD		15–100	Twin
HFD		15–100	Twin
FDC		15–100	Twin
FCL		15–100	Twin
FB-P		15–100	Twin
FDB	150	110–150	Twin
FD	225	110–225	Twin
HFD		110–225	Twin
FDC		110–225	Twin
ED		100–225	Twin
EDH		100–225	Twin
EDC		100–225	Twin
JD	250	70–250	Twin/single
HJD		70–250	Twin/single
JDC		70–250	Twin/single
DK	400	100–400	Twin/single
KD		100–400	Twin/single
HKD		100–400	Twin/single
KDC		100–400	Twin/single
CKD		100–400	Single
LCL		125–400	Single
LA-P		70–400	Single
LD	600	300–600	Single
CLD		300–600	Single
HLD		300–600	Single
CHLD		300–600	Single
LDC		300–600	Single
CLDC		300–600	Single
MDL	800	300–800	Single
CMDL		300–800	Single
HMDL		300–800	Single
CHMDL		300–800	Single
ND	1200	600–1200	Single
CND		600–1200	Single
HND		600–1200	Single
CHND		600–1200	Single
NDC		600–1200	Single
CNDC		600–1200	Single

How to order a breaker retrofit kit by catalog number

Use “KPRL4” prefix and add catalog number of breaker as shown below. Use suffix “T” or “S” to denote twin or single mounting. Twin-mounting indicates that one set of connectors is required to mount two breakers (of similar frames) opposite one another. Retrofit kit includes one breaker only, for either single or twin-mounted applications.

Table 40. Catalog numbering system—breaker retrofit kit

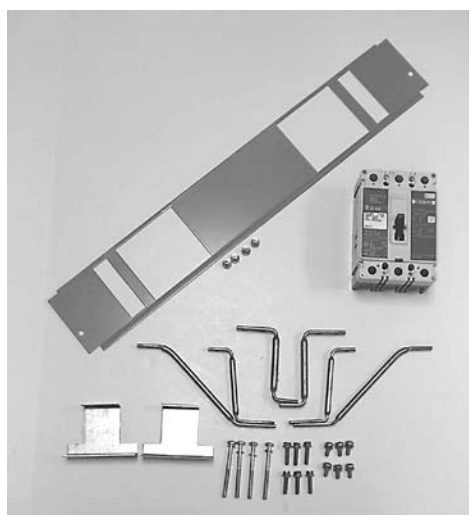
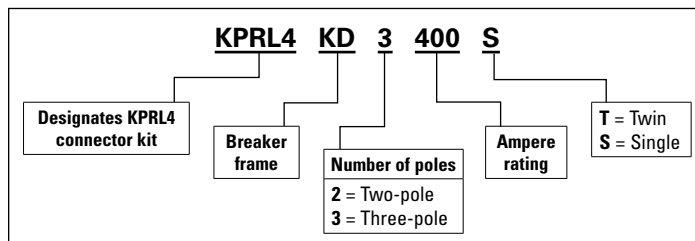

Breaker retrofit kit

Fusible retrofit kits

Each kit includes a three-pole switch, copper connectors, extension wings (if required), hardware, and instructions to horizontally mount in a PRL4.

Table 41. Fusible retrofit kits

Switch ampere rating	Switch type	Mounting type
30–30	FDPW	Twin
60–60	FDPW	Twin
100–100	FDPW	Twin
100	FDPW	Single
200	FDPB	Single
200–200	FDPB	Twin
400	FDPW	Single
600	FDPW	Single
800	FDPW	Single
1200	FDPW	Single

How to order a fusible retrofit kit by catalog number

Use “KPRL4” prefix and add catalog number of appropriate switch (refer to **page 26** for three-pole switch catalog number).

Example: The retrofit kit catalog number for a 600 V, 100 A twin FDPW switch is:

Table 42. Catalog numbering system—fusible retrofit kit

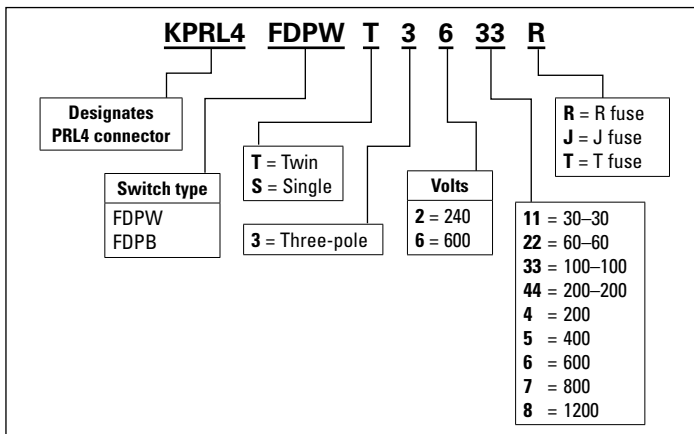

PRL1a, 2a, 3a EZ trims and enclosures

EZ trim

PRL1a, 2a, and PRL3a EZ trim and EZ box meet code requirements for both Type 1 standards. Features include a door-in-door standard with no exposed hardware and laser-cut trim with rounded corners. For EZ boxes and EZ trims, refer to **page 28**.

Example: EZT2048 and EZB2048.



EZ trim

Table 43. EZ trim

Encl. height	Box				Trim							
	Unpainted		Painted		Unvented surface mounted		Unvented flush mounted		Vented surface mounted		Vented flush mounted	
	Catalog number	Style number	Catalog number	Style number	Catalog number	Style number	Catalog number	Style number	Catalog number	Style number	Catalog number	Style number
24	EZB2024R	42C1999G01	EZBP2024R	42C1999G13	EZT2024S	42C4255G01	EZT2024F	42C4258G01	EZTV2024S	42C4261G01	EZTV2024F	42C4264G01
30	EZB2030R	42C1999G02	EZBP2030R	42C1999G14	EZT2030S	42C4255G02	EZT2030F	42C4258G02	EZTV2030S	42C4261G02	EZTV2030F	42C4264G02
36	EZB2036R	42C1999G03	EZBP2036R	42C1999G15	EZT2036S	42C4255G03	EZT2036F	42C4258G03	EZTV2036S	42C4261G03	EZTV2036F	42C4264G03
42	EZB2042R	42C1999G04	EZBP2042R	42C1999G16	EZT2042S	42C4255G04	EZT2042F	42C4258G04	EZTV2042S	42C4261G04	EZTV2042F	42C4264G04
48	EZB2048R	42C1999G05	EZBP2048R	42C1999G17	EZT2048S	42C4255G05	EZT2048F	42C4258G05	EZTV2048S	42C4261G05	EZTV2048F	42C4264G05
54	EZB2054R	42C1999G06	EZBP2054R	42C1999G18	EZT2054S	42C4255G06	EZT2054F	42C4258G06	EZTV2054S	42C4261G06	EZTV2054F	42C4264G06
60	EZB2060R	42C1999G07	EZBP2060R	42C1999G19	EZT2060S	42C4255G07	EZT2060F	42C4258G07	EZTV2060S	42C4261G07	EZTV2060F	42C4264G07
72	EZB2072R	42C1999G09	EZBP2072R	42C1999G21	EZT2072S	42C4255G09	EZT2072F	42C4258G09	EZTV2072S	42C4261G09	EZTV2072F	42C4264G09
90	EZB2090R	42C1999G12	EZBP2090R	42C1999G24	EZT2090S	42C4255G12	EZT2090F	42C4258G12	EZTV2090S	42C4261G12	EZTV2090F	42C4264G12

PRL1a, 2a, 3a special trims and enclosures

Fastrim

Used when concealed trim-mounting hardware is required for PRL1a, 2a, and PRL3a. Trim clamps are included and shipped with the trim. Order by adding the letter "F" to the standard trim catalog number. Add 20% to standard trim list price.

Example: LT2072S becomes **LTF2072S**.

For trim clamps only, refer to **page 18**.



Fastrim

Door-in-door

Piano hinge on the right side of the trim provides access to the wiring gutters without requiring removal of the trim. Order by adding the letters "DD" to the standard trim catalog number. Add 20% to standard trim list price.

Example: LT2072S becomes **LTDD2072S**.



Door-in-door

Ventilated trim

Required on 600 A and above panels only. Order by adding the letter "V" to the standard trim catalog number. Add 10% to standard trim list price.

Example: LT2072S becomes **LTV2072S**.



Ventilated trim

Type 12/3R enclosures

The complete enclosure consists of a box and trim. The enclosure meets code requirements for both Type 12 (dust-tight) and Type 3R (rainproof) standards. Features include a laser-cut trim with rounded corners, concealed hinges, and a T-handle lock. Gasketing is provided around the trim door.

The box is gasketed and made from code gauge steel with dripshield and is painted ANSI-61.

Table 44. Type 12/3R enclosures for PRL1a, 2a, 3a

Box dimensions in inches (mm)			Catalog number	
Height	Width	Depth	Box	Trim
24.00 (609.6)	20.00 (508.0)	6.00 (152.4)	VWPB2024	LWPT2024
36.00 (914.4)	20.00 (508.0)	6.00 (152.4)	VWPB2036	LWPT2036
48.00 (1219.2)	20.00 (508.0)	6.00 (152.4)	VWPB2048	LWPT2048
60.00 (1524.0)	20.00 (508.0)	6.00 (152.4)	VWPB2060	LWPT2060
72.00 (1828.8)	20.00 (508.0)	6.00 (152.4)	VWPB2072	LWPT2072
90.00 (2286.0)	20.00 (508.0)	6.00 (152.4)	VWPB2090	LWPT2090



Type 12/3R enclosures

PRL4 special trims and enclosures

Door-in-door trim



Door-in-door trim

A piano hinge on the right side of the trim provides access to the wiring gutter without requiring the removal of the trim. When used with a standard PRL4 box, a special mounting channel must be used to add extra depth to the enclosure.

An extra depth box, not requiring a mounting channel, is another available option. Contact your local satellite for ordering information.

Table 45. Special trims and enclosures

Standard box catalog number	Mounting channel style number	Door-in-door trim catalog number	
		Surface	Flush
BX2457	8708C82G02	LDD2457STW	LDD2457FTW
BX2473	8708C82G03	LDD2473STW	LDD2473FTW
BX2490	8708C82G04	LDD2490STW	LDD2490FTW
BX3673	8708C82G05	LDD3673STW	LDD3673FTW
BX3690	8708C82G06	LDD3690STW	LDD3690FTW
BX4473	8708C82G07	LDD4473STW	LDD4473FTW
BX4490	8708C82G08	LDD4490STW	LDD4490FTW

Type 12/3R enclosures



Type 12, 24.00 inches (609.6 mm) wide



Type 3R, 36.00 inches (914.4 mm) wide

PRL4 enclosures are available in both Type 12 (dust-tight) and Type 3R (rainproof) designs. The 24.00-inch (609.6 mm) wide enclosure includes a single hinged door while the 36.00-inch (914.4 mm) wide is provided with double hinged doors.

The side gutter covers are an integral part of the box in all styles. Sizes and catalog numbers are shown in **Table 46**.

Table 46. Type 12/3R enclosures

Enclosure dimensions in inches (mm)			Catalog number	
Height	Width	Depth	Type 3R	Type 12
57.00 (1447.8)	24.00 (609.6)	13.90 (353.1)	RPC2457	DPC2457
73.00 (1854.2)	24.00 (609.6)	13.90 (353.1)	RPC2473	DPC2473
90.00 (2286.0)	24.00 (609.6)	13.90 (353.1)	RPC2490	DPC2490
73.00 (1854.2)	36.00 (914.4)	13.90 (353.1)	RPC3673	DPC3673
90.00 (2286.0)	36.00 (914.4)	13.90 (353.1)	RPC3690	DPC3690

Ordering procedure

Step 1

Select the correct part or branch device. When selecting, you need to know the following:

- Panelboard type
- Amperage
- System voltage
- Available short-circuit rating
- Number of poles available
- Size and number of wires per phase
- "X" space required

Step 2

Refer to the 5P panelboard layout on **page 31** to verify the amount of "X" space available.

Step 3

Create a 5P breaker unit catalog number, by following the instructions on **page 32**, or order the catalog number for parts on **page 33** and **page 34**.

Step 4

Determine if extra filler covers are required. Additional filler covers may be necessary to fill the unused space. Refer to **page 34** for filler plate information.

PRL5P parts section

Description	Page
Chassis layout	31
Breake assemblies catalot numbers	32
Branch devices	32–33
Main or through-feed lugs	33
Neutrals and grounds	34
Box, trim, and deadfront filler plates	34

PRL5P chassis layout

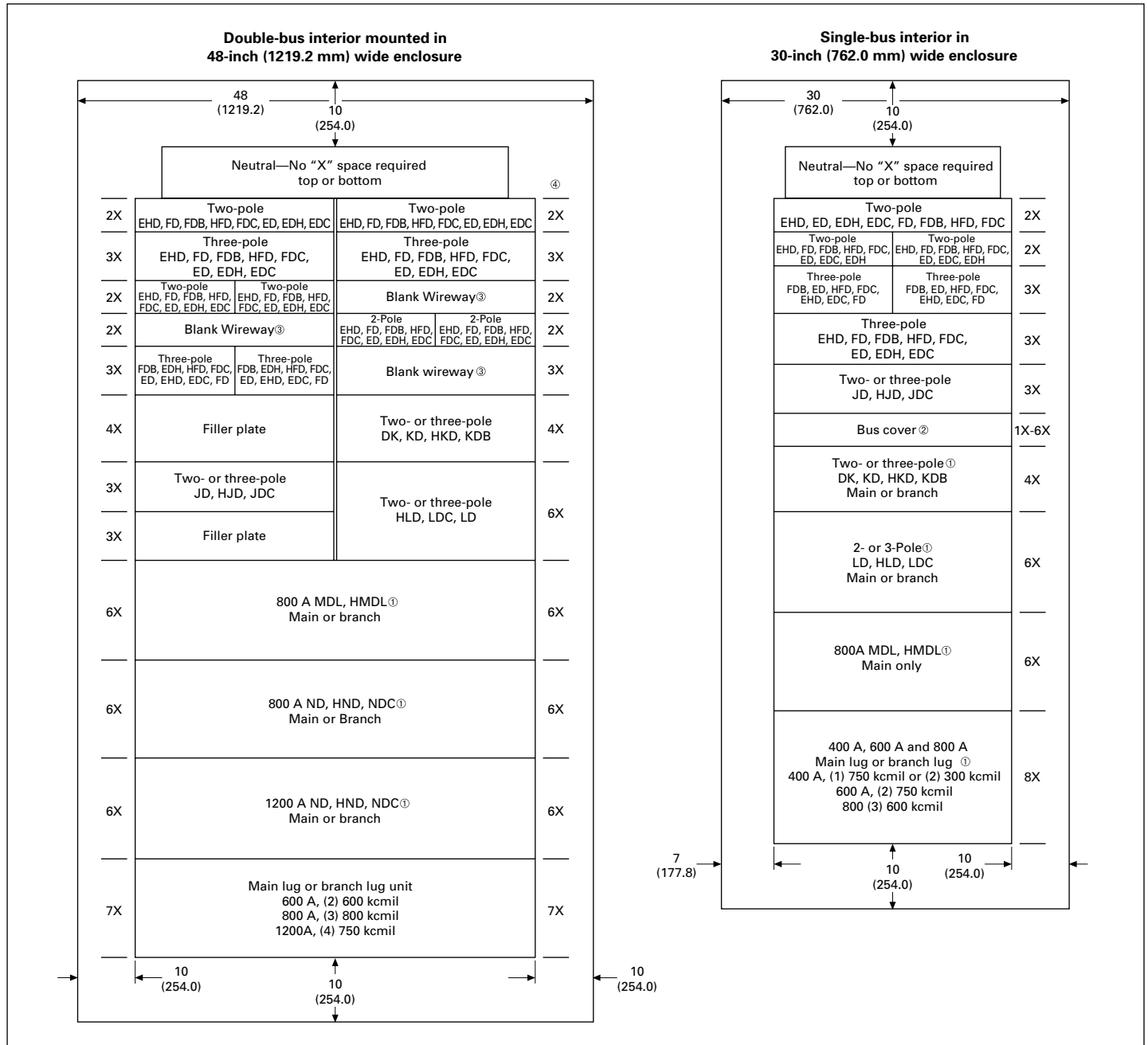
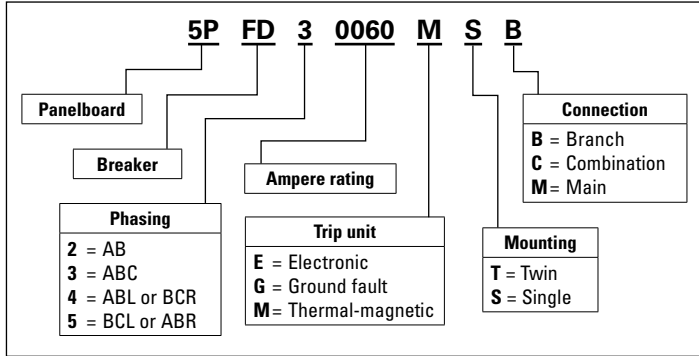

Figure 3. PRL5P chassis layout—dimensions in inches (mm)

① If used as a main device, must be mounted at the neutral end of panel.
 ② Fixed bus covers are required for unused spaces if NEC® six-circuit disconnect rule is to be met.
 ③ Blank wireway fillers are required opposite any dual breaker unit.
 ④ One “X” = 1.38 inches (35.1 mm).

PRL5P breaker assemblies catalog numbers

Table 47. Catalog numbering system—5P single or twin breakers with adapters



A plug-on unit is a complete assembly with a circuit breaker and mounting adapter to mount on a 5P panelboard.

Single indicates units that may be mounted in a single or double bus panel, and twin indicates double bus panels only. See **Table 50** and **Table 51**.

Table 48. Catalog numbering system—5P dual breakers with adapters

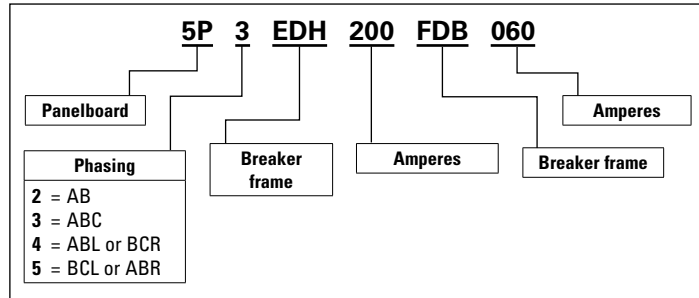

Any two F-Frame breakers listed may be mounted on the same 2X or 3X dual breaker adapter.

Dual breaker adapters may be used in single or double bus panels. Dual breaker adapters can **NOT** be mounted across from another adapter in a double bus panel. See **Table 52**.

Branch devices

Single-pole breakers in single adapter units. Include two or three single-pole 15–60 A assembled on one unit. (One X = 1.38 inches [35.1 mm])

Table 49. Single-pole breakers in single adapter units

Breaker type	Ampere rating	Interrupting rating (kA sym.)				"X" space required
		120 Vac	240 Vac	277 Vac	125 Vdc	
EHD	15–60	—	—	14	10	2X
FD	15–60	—	—	25	10	2X
HFD	15–60	—	—	65	10	2X
EHD	15–60	—	—	14	10	3X
FD	15–60	—	—	25	10	3X
HFD	15–60	—	—	65	10	3X

Table 50. Two- and three-pole breakers in single adapter units

Breaker type	Ampere rating	Interrupting rating (kA sym.)				"X" space required
		240 Vac	480 Vac	600 Vac	250 Vdc	
ED	100–225	65	—	—	—	3X
EDH	100–225	100	—	—	—	3X
EDC	100–225	200	—	—	—	3X
EHD	15–60	18	14	—	10	3X
EHD	70–100	18	14	—	10	3X
FD	15–60	65	25	18	10	3X
FD	70–100	65	25	18	10	3X
FD	110–225	65	25	18	10	3X
HFD	15–60	100	65	25	22	3X
HFD	70–100	100	65	25	22	3X
HFD	110–225	100	65	25	22	3X
FDC	15–60	200	100	35	22	3X
FDC	70–100	200	100	35	22	3X
FDC	110–225	200	100	35	22	3X
JD, JDB	70–225	65	35	18	10	3X
JD, JDB	70–225	65	35	18	10	3X
HJD	250	100	65	25	22	3X
HJD	70–225	100	65	25	22	3X
JDC	250	200	100	35	22	3X
JDC	70–225	200	100	35	22	3X
DK	100–400	65	—	—	—	4X
KD, KDB	250–400	65	35	25	10	4X
HKD	250–400	100	65	35	22	4X
KDC	250–400	200	100	50	22	4X
LD, LDB	300–600	65	35	25	22	6X
HLD ①②	300–600	100	65	35	25	6X
LDC	300–600	200	100	50	25	6X
MDL ①②	400–800	65	50	25	22	6X
HMDL ①②	400–800	100	65	35	25	6X
ND	400–1200	65	50	25	—	6X
HND ①②	400–1200	100	65	35	—	6X
NDC	400–1200	200	100	50	—	6X

① For use only in double bus chassis panelboards.

② 100% rated breakers are NOT available in 5P panelboards.

Dual breaker adapters—Any two breakers listed in **Table 52** may be mounted on the same 2X or 3X dual breaker adapter.

Dual breaker adapters may be used in single or double bus chassis. Dual breaker adapters can **NOT** be mounted across from another in a double bus chassis. (One X = 1.38 inches [35.1 mm]).

Table 51. Dual breaker adapters

Breaker type	Ampere rating	Interrupting rating (kA sym.)				"X" space required
		240 Vac	480 Vac	600 Vac	250 Vdc	
ED	100–225	65	—	—	—	3X
EDH	100–225	100	—	—	—	3X
EDC	100–225	200	—	—	—	3X
EHD	15–60	18	14	—	10	3X
EHD	70–100	18	14	—	10	3X
FD	15–60	65	25	18	10	3X
FD	70–100	65	25	18	10	3X
FD	110–225	65	25	18	10	3X
HFD	15–60	100	65	25	22	3X
HFD	70–100	100	65	25	22	3X
HFD	110–225	100	65	25	22	3X
FDC	15–60	200	100	35	22	3X
FDC	70–100	200	100	35	22	3X
FDC	110–225	200	100	35	22	3X



5PFD30060MSB

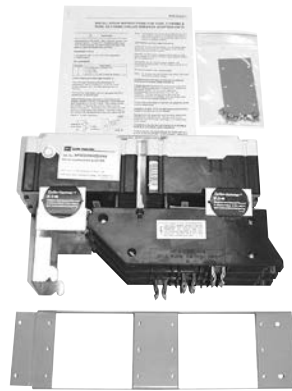

5P3EDH200FDB060

PRL5P main or through-feed lugs

Table 52. PRL5P main or through-feed lugs

Description	Ampere rating	Wire size range	"X" space required	Catalog number
Single bus chassis mounting				
Ampere lug unit	400	(1) 1/0–500 or (2) 1/0–250 kcmil	8X	5PLUG3400SC
Ampere lug unit	600	(2) 1/0–500 kcmil	8X	5PLUG3600SC
Ampere lug unit	800	(2) #2–500 or (3) #2–400 kcmil	8X	5PLUG3800SC
Double bus chassis mounting				
1200 A lug unit	600–1200	(4) #4–750 kcmil	7X	5PLUG31200TC



5PLUG3800SC



5PLUG31200TC

PRL5P neutrals and grounds

Neutral assembly

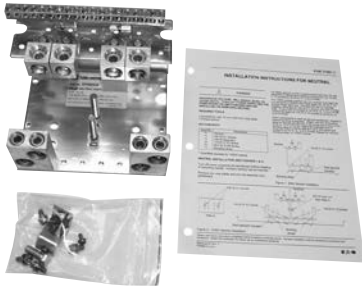

5PN800A

Table 53. Neutral assemblies with lugs

Incoming number of cables and wire size	Catalog number
(4) 250–500 kcmil 800 A aluminum/copper	5PN800A
(4) 250–500 kcmil 800 A copper	5PN800C
(4) 250–500 kcmil 1200 A aluminum/copper	5PN1200A
(4) 250–500 kcmil 1200 A copper	5PN1200C

Table 54. Additional lugs for neutral assemblies

Description	Catalog number
(1) 1/0–750 kcmil or (2) 1/0–300 kcmil aluminum/copper	5PNL400
(2) 250–500 kcmil aluminum/copper	5PNL600
(3) 3/0–750 kcmil aluminum/copper	5PNL800
(4) 3/0–750 kcmil aluminum/copper	5PNL1200
Ground bar type	
1200 A aluminum/copper	5PG1200A
1200 A copper	5PG1200C

Ground bar assemblies

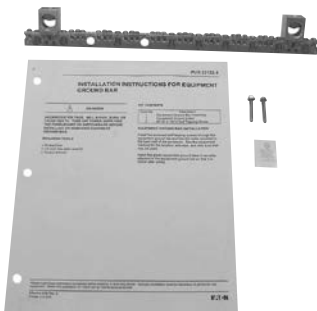

5PG1200A

Table 55. Grounded “B” phase adapter kits

Ampere rating	Main device	Catalog number
Single bus chassis		
400	Main lugs	5PCGBLUG400S
600	Main lugs	5PCGBLUG600S
600	LD breaker	5PCGBLD600S
800	Main lugs	5PCGBLUG800S
Double bus chassis		
800	MD breaker	5PCGBMD800T
1200	Main lugs	5PCGBLUG1200T
1200	ND breaker	5PCGBND1200T

PRL5P box, trim, and deadfront filler plates

Table 56. PRL5P box, trim, and deadfront filler plates

Chassis “X” factor	Catalog number		
	Back box	Trim	Trim door kit
Single bus chassis—30.00-Inch (762.0 mm) wide box			
24X	5PB2430G	5PT2430S	5PD24S
32X	5PB3230G	5PT3230S	5PD32S
40X	5PB4030G	5PT4030S	5PD40S
Double bus chassis—48.00-Inch (1219.2 mm) wide box			
24X	5PB2448G	5PT2448S	5PD24T
32X	5PB3248G	5PT3248S	5PD32T
40X	5PB4048G	5PT4048S	5PD40T

Table 57. Deadfront filler plates

Vertical “X” increment	Catalog number	
	Single bus chassis ①	Double bus chassis
1X	5PFP1S	5PFP1T
2X	5PFP2S	5PFP2T
3X	5PFP3S	5PFP3T
4X	5PFP4S	5PFP4T
5X	5PFP5S	5PFP5T
6X	5PFP6S	5PFP6T

① These fillers are also used across from a breaker unit in a double bus chassis.



5PT2430S



5PD24S



5PFP3S



5PFP3T

PRL1a, 2a-LX

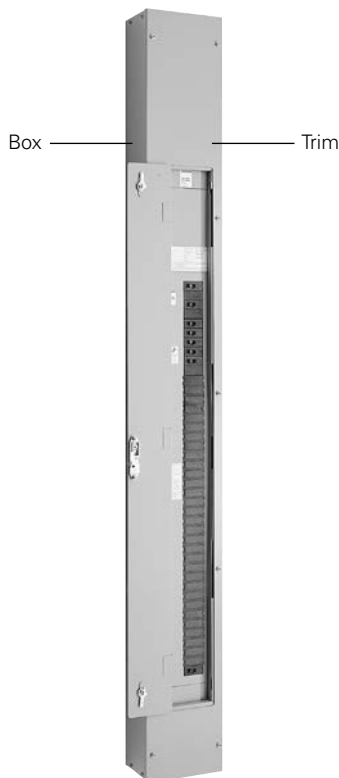

Pow-R-Command

For replacement parts, see PRL3a section, **page 19**.
The following parts are available:

- Connector kits
- Ground assemblies
- Service entrance kits
- Deadfront covers
- Trim locks



Pow-R-Command

Table 58. Type 1 box and trims

Box height in inches (mm)	Catalog number		
	Box	Surface trim standard	Surface trim door-in-door
Incoming location top fed			
69.00 (1752.6)	YSC969	LTC969S	LTCD969S
78.00 (1981.2)	YSC978	LTC978S	LTCD978S
81.00 (2057.4)	YSC981	LTC981S	LTCD981S
90.00 (2286.0)	YSC990	LTC990S	LTCD990S
Incoming location bottom fed			
69.00 (1752.6)	YSC969	LTC969SB	LTCD969SB
78.00 (1981.2)	YSC978	LTC978SB	LTCD978SB
81.00 (2057.4)	YSC981	LTC981SB	LTCD981SB
90.00 (2286.0)	YSC990	LTC990SB	LTCD990SB

Additional services

Because virtually all panelboards are supplied to meet specific customer requirements, other parts not listed in this publication might occasionally be needed. Price and availability for parts not shown here may be obtained by contacting your local satellite plant and providing a complete description of the part along with the data on the panelboard nameplate.

Should you experience difficulty in determining what replacement parts are needed, contact your local satellite plant manager who can provide help to:

- Identify and recommend replacement parts
- Remove damaged parts and instruct you in how to install replacement parts
- Verify the correct connector kits that should be ordered for each circuit breaker or fusible switch
- Retrofit existing panelboard boxes with new Pow-R-Line interiors
- Provide a recommended spare parts list

Eaton
1000 Eaton Boulevard
Cleveland, OH 44122
United States
Eaton.com

© 2017 Eaton
All Rights Reserved
Printed in USA
Publication No. RP01400001E / Z19610
October 2017



Eaton is a registered trademark.
All other trademarks are property
of their respective owners.

Current Eaton panelboards



Contents

Description	Page	Description	Page
Procedure for identifying panelboard type	2	PRL4 parts	
Procedure for identifying renewal parts	2	Vented cover assemblies and side gutter covers	23
Distributor ordering instructions	2	Blank covers	24
Eaton satellite plants	3	Breaker connector kits	24
PRL1a, 2a parts		Fusible connector kits	25
Connector kits, vertical breakers	4	Breaker retrofit kits	26
Connector kits, lug assemblies	5	Fusible retrofit kits	27
Connector kits, horizontally mounted, PRL1a	8	PRL1a, 2a, 3a EZ trims and enclosures	27
Neutral assemblies	11	PRL1a, 2a, 3a special trims and enclosures	28
Ground assemblies	15	PRL4 special trims and enclosures	29
Service entrance bonding jumper kits	15	Type 12/3R enclosures	30
Service entrance main breaker kits	15	Ordering procedure	30
Deadfront covers	16	PRL5P parts	
Special trim locks	18	Chassis layout	31
EZ trim locks	18	Breaker adapter unit catalog numbers	32
Fastrim clamps and hardware kits	18	Branch breaker information	32
PRL3a parts		Main or through-feed lugs	33
Connector kits assemblies	19	Neutrals and grounds	34
Ground assemblies	20	Boxes, trims, and filler plates	34
Service entrance bonding jumper kits	20	PRL1a, 2a-LX column panelboards	35
Service entrance main breaker kits	20	Pow-R-Command	35
Deadfront covers	20	Additional services	35



Powering Business Worldwide

Effective October 2017

Table 1. Product history time line

Product	1985	1990	1995	Present
PRL1a, 2a			← Oct. 1996 →	
PRL3a			← Mar. 1994 →	
PRL4B/F	←			→ Oct. 1987
PRL5P			← Aug. 1995 →	
PRL1a, 2a-LX			← Dec. 1997 →	
Pow-R-Command™			← Mar. 1996 →	

Procedure for identifying panelboard type

The current line of Pow-R-Line C™ panelboards was introduced in 1993.

A panelboard is identified by data found on the nameplate. Pow-R-Line C panelboard nameplates are different in appearance, but all have the same critical information:

- Ampere rating of the main
- Ampere rating of the neutral
- Type of service (phase/wire)
- Manufacturing location
- Type of panel
- General order number

In the event the nameplate is missing, it may still be possible to identify the panel type by location of the neutral bar. **Figure 1** shows the position of the neutral in the panelboard.

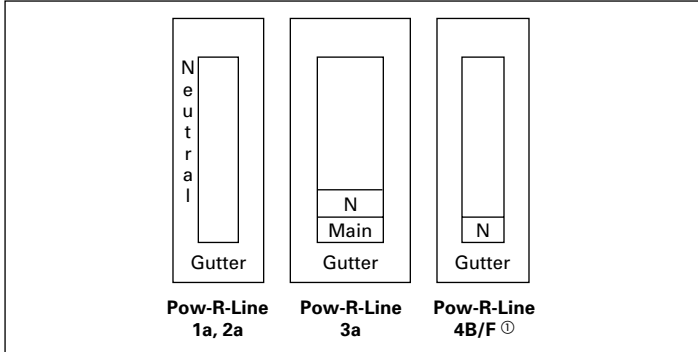

Figure 1. Position of the neutral in the panelboard

① PRL4F panels with vertical-mounted main switch will have the neutral mounted at the opposite end the main.

Box width may also help identify the panelboard type. Standard width for PRL1a, PRL2a, and PRL3a is 20.00 inches (508.0 mm). PRL4 standard widths are 24.00, 36.00, and 44.00 inches (609.6, 914.4, and 1117.6 mm).

Procedure for identifying renewal parts

1. Identify the type of panelboard, i.e., PRL1a, PRL2a, PRL3a, PRL4, PRL5P by reading the nameplate. Follow the procedure listed to the left.
2. Refer to the listing below and turn to the proper section in this document to identify standard parts.

Description

Page

PRL1a and PRL2a	4
Trim locks	18
Trim clamps	18
PRL3a	19
PRL4	23
Special trims and enclosures	29
PRL5P	31
PRL1a-LX and PRL2a-LX (column width)	35
Pow-R-Command	35

3. This book identifies those replacement parts most frequently ordered and which are readily available from stock. These parts can be ordered by style or catalog number to speed up processing and delivery.

Distributor ordering instructions

1. Specify part by style/part number.
2. Refer to PL01400001E for pricing information. Discount Symbol CE9 applies.
3. Turn to **page 3** to locate nearest satellite plant.
4. Enter the order on the satellite plant via mail, fax, or phone.
5. Selling policy 25-000 applies.

⚠ WARNING

HAZARDOUS VOLTAGE WILL CAUSE SEVERE INJURY OR DEATH. TURN OFF POWER SUPPLY TO EQUIPMENT BEFORE WORKING ON IT.

Eaton satellite plants

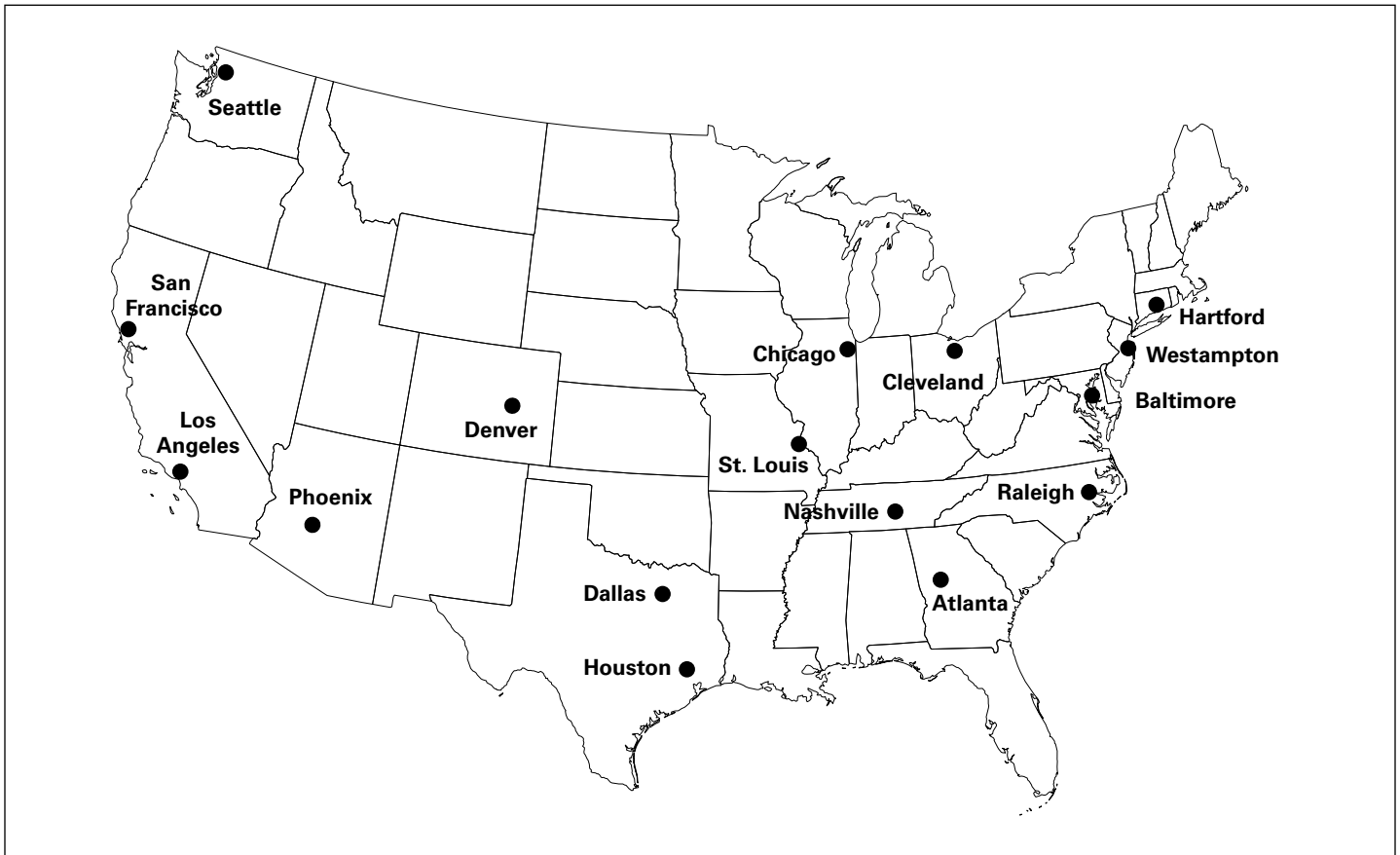

Figure 2. Satellite plants

Atlanta

7000 Highlands Parkway SE
Suite 102
Smryna, GA 30082
678.309.4260

Baltimore

7451 Coca Cola Drive
Suite C
Hanover, MD 21076
410.796.7777

Chicago

230 Windy Point Drive
Glendale Heights, IL 60139
630.260.6303

Cleveland

12875 Corporate Drive
Unit E
Parma, OH 44130
216.265.3284

Dallas

631 Westport Parkway
Suite 100
Grapevine, TX 76051
817.251.6733

Denver

2450 Airport Road
Suite C
Aurora, CO 80011
303.366.2080

Hartford

40A International Drive
Windsor, CT 06095
860.298.1305

Houston

14825 Northwest Freeway
Suite 100
Houston, TX 77040
713.744.7530

Los Angeles–P&S

13201 Dahlia Street
Suite 300
Fontana, CA 92337
919.428.8903

Nashville

1421 Gould Boulevard
Suite C
La Vergne, TN 37086
615.287.3200

Phoenix

560 N 54th Street
Suite 1
Chandler, AZ 85226
480.449.4222

Raleigh

9400 Globe Center Drive
Suite 121
Morrisville, NC 27560
919.544.7074

St. Louis

56 Soccer Park Road
Fenton, MO 63026
636.717.3500

San Francisco

20923 Cabot Boulevard
Hayward, CA 94545
510.784.8981

Seattle

1604 15th Street SW
Suite 114
Auburn, WA 98001
253.833.5021

Westampton

96 Stemmers Lane
Westampton, NJ 08060
609.835.4230

PRL1a, 2a parts section

Description	Page
Connector kits, vertical breakers	4
Connector kits, lug assemblies	5–7
Connector kits, horizontally mounted	8–10
Neutral assemblies	11–14
Ground assemblies	15
Service entrance bonding jumper kits.	15
Service entrance main breaker kits.	15
Deadfront covers.	16–17
Panelboard special trim locks	18
Panelboard EZ trim locks.	18
Panelboard Fastrim clamps and screw-on hardware kits	18

PRL1a, 2a connector kits

Table 2. Vertical breaker assemblies

Device type ①	Device mounting	Three-phase		Single-phase	
		Tin-plated aluminum connector	Silver-plated copper connector	Tin-plated aluminum connector	Silver-plated copper connector
		Catalog number			
F-Frame ② (100 A maximum)	Top fed	KB13AFT	KB13SFT	KB11AFT	KB11SFT
	Bottom fed	KB13AFB	KB13SFB	KB11AFB	KB11SFB
F-Frame ③ (225 A maximum)	Top fed	KB23AFT	KB23SFT	KB21AFT	KB21SFT
	Bottom fed	KB23AFB	KB23SFB	KB21AFB	KB21SFB
J-Frame	Top fed	KB43AJT	KB43SJT	KB41AJT	KB41SJT
	Bottom fed	KB43AJB	KB43SJB	KB41AJB	KB41SJB
K-Frame	Top fed	KB43AKT	KB43SKT	KB41AKT	KB41SKT
	Bottom fed	KB43AKB	KB43SKB	KB41AKB	KB41SKB

① Order main or sub-feed breaker separately when ordering above connector kits.

② EHD, FD, HFD, FDC.

③ FD, HFD, FDC, ED, EDH, EDC.

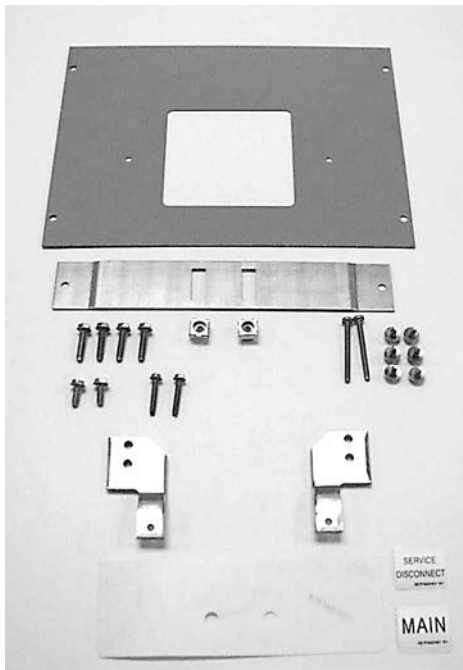

KB11AFT

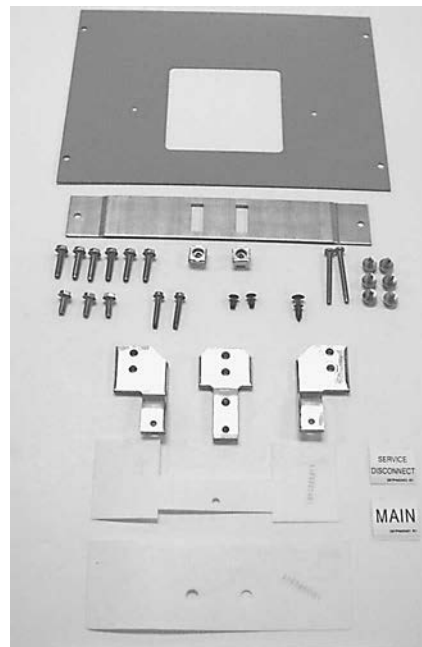

KB13AFT

Table 3. 100 A lug assemblies

Lug type	Panel lug options ①	Wire size range	Quantity per phase	Three-phase		Single-phase	
				Tin-plated aluminum connector Catalog number	Silver-plated copper connector	Tin-plated aluminum connector	Silver-plated copper connector
Aluminum/copper mechanical	STD	#14-1/0	1	KL13AMS	KL13SMS	KL11AMS	KL11SMS
	SFL	#14-1/0	2	KL13AMF	KL13SMF	KL11AMF	KL11SMF
	OVS	#6-300 kcmil	1	KL13AMO	KL13SMO	KL11AMO	KL11SMO
Crimp	STD	#1-1/0	1	KL13AVS	KL13SVS	KL11AVS	KL11SVS
	SFL	#1-1/0	2	KL13AVF	KL13SVF	KL11AVF	KL11SVF
	OVS	2/0-300 kcmil	1	KL13AVO	KL13SVO	KL11AVO	KL11SVO
Copper mechanical	STD	#14-1/0	1	—	KL13SCS	—	KL11SCS
	SFL	#14-1/0	2	—	KL13SCF	—	KL11SCF
	OVS	#6-250 kcmil	1	—	KL13SCO	—	KL11SCO

① STD = Standard lugs. Use for main or through-feed.

SFL = Sub-feed lugs.

OVS = Oversize lugs. Use for main or through-feed.



KL13AMS



KL11AVS

Effective October 2017

Table 4. 225 A lug assemblies

Lug type	Panel lug options ①	Wire size range	Quantity per phase	Three-phase		Single-phase	
				Tin-plated aluminum connector Catalog number	Silver-plated copper connector	Tin-plated aluminum connector	Silver-plated copper connector
Aluminum/copper mechanical	STD	#6–300 kcmil	1	KL23AMS	KL23SMS	KL21AMS	KL21SMS
	SFL	#6–300 kcmil	2	KL23AMF	KL23SMF	KL21AMF	KL21SMF
	OVS	4/0–500 kcmil	1	KL23AMO	KL23SMO	KL21AMO	KL21SMO
Crimp	STD	2/0–300 kcmil	1	KL23AVS	KL23SVS	KL21AVS	KL21SVS
	SFL	2/0–300 kcmil	2	KL23AVF	KL23SVF	KL21AVF	KL21SVF
	OVS	4/0–500 kcmil	1	KL23AVO	KL23SVO	KL21AVO	KL21SVO
Copper mechanical	STD	#6–250 kcmil	1	—	KL23SCS	—	KL21SCS
	SFL	#6–250 kcmil	2	—	KL23SCF	—	KL21SCF
	OVS	1/0–600 kcmil	1	—	KL23SCO	—	KL21SCO

① STD = Standard lugs. Use for main or through-feed.
 SFL = Sub-feed lugs.
 OVS = Oversize lugs. Use for main or through-feed.



KL23AMS



KL21AVS

Table 5. 400 A lug assemblies

Lug type	Panel lug options ①	Wire size range	Quantity per phase	Three-phase		Single-phase	
				Tin-plated aluminum connector Catalog number	Silver-plated copper connector	Tin-plated aluminum connector	Silver-plated copper connector
Aluminum/copper mechanical	STD	4/0–500 kcmil	2	KL43AMS	KL43SMS	KL41AMS	KL41SMS
	SFL	—	—	—	—	—	—
	OVS	3/0–750 kcmil	2	KL43AMO	KL43SMO	KL41AMO	KL41SMO
Crimp	STD	4/0–500 kcmil	2	KL43AVS	KL43SVS	KL41AVS	KL41SVS
	SFL	—	—	—	—	—	—
	OVS	500–750 kcmil	2	KL43AVO	KL43SVO	KL41AVO	KL41SVO
Copper mechanical	STD	1/0–600 kcmil	1	—	—	—	—
	SFL	—	—	—	—	—	—
	OVS	1/0–600 kcmil	1	—	KL43SCO	—	KL41SCO

① STD = Standard lugs. Use for main or through-feed.
 SFL = Sub-feed lugs.
 OVS = Oversize lugs. Use for main or through-feed.

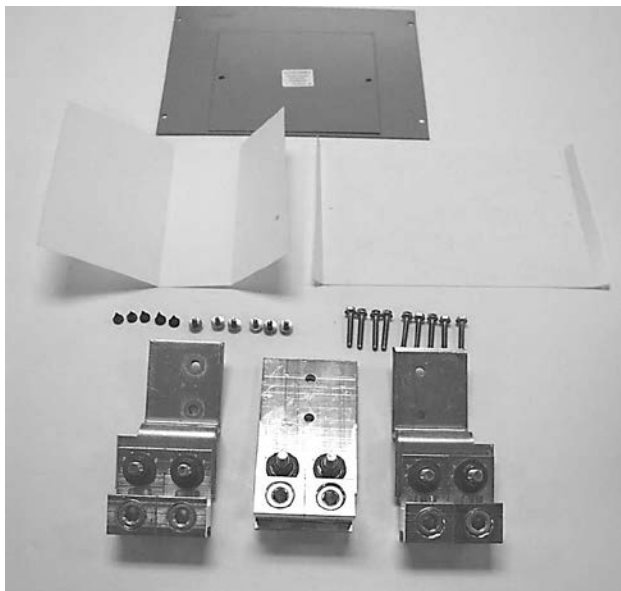

KL43AMS

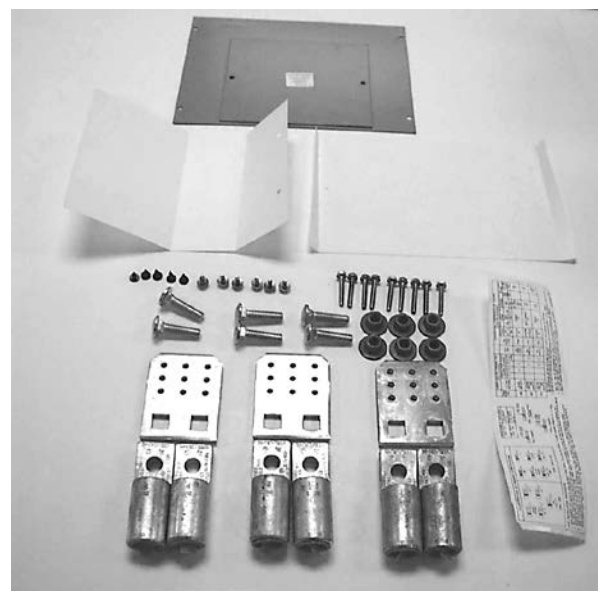

KL43AVS

Table 6. 600 A lug assemblies

Lug type	Panel lug options ①	Wire size range	Quantity per phase	Three-phase connectors			Single-phase connectors				
				Tin-plated aluminum Catalog number	Bare copper	Silver-plated copper	Tin-plated copper	Tin-plated aluminum	Bare copper	Silver-plated copper	Tin-plated copper
Aluminum/copper mechanical	STD	4/0–500 kcmil	2	—	KL63CMS	KL63SMS	KL63TMS	—	KL61CMS	KL61SMS	KL61TMS
	SFL	—	—	—	—	—	—	—	—	—	—
	OVS	3/0–750 kcmil	2	—	KL63CMO	KL63SMO	KL63TMO	—	KL61CMO	KL61SMO	KL61TMO
Crimp	STD	4/0–500 kcmil	2	—	KL63CVS	KL63SVS	KL63TVS	—	KL61CVS	KL61SVS	KL61TVS
	SFL	—	—	—	—	—	—	—	—	—	—
	OVS	500–750 kcmil	2	—	KL63CVO	KL63SVO	KL63TVO	—	KL61CVO	KL61SVO	KL61TVO
Copper mechanical	STD	1/0–600 kcmil	1	—	—	—	—	—	—	—	—
	SFL	—	—	—	—	—	—	—	—	—	—
	OVS	1/0–600 kcmil	1	—	—	—	—	—	—	—	—

① STD = Standard lugs. Use for main or through-feed.
 SFL = Sub-feed lugs.
 OVS = Oversize lugs. Use for main or through-feed.

PRL1a horizontally mounted connector kit assemblies

Table 7. Bolt-on QUICKLAG® breaker assemblies

Breaker frame	Drawing number ①	Branch circuit quantity	Three-phase		Single-phase	
			Tin-plated aluminum connector Item number	Silver-plated copper connector	Tin-plated aluminum connector	Silver-plated copper connector
BA, BAB, QBH, QBGF, QBHGF, QBGFEP, QBHGFEP	1C96608	12	G01	G03	G05	G07
		18	G09	G11	G13	G15
		30	G17	G19	G21	G23
		42	G25	G27	G29	G31
		48	G33	G35	G37	G39
		54	G41	G43	G45	G47
		72	G49	G51	G53	G55
		96	G57	G59	G61	G63

① Order the basic drawing number, along with the equivalent G-number that's needed.

Note: When determining branch circuit quantity, remember:

1. QUICKLAG breakers with shunt trips require one additional circuit.
2. UL® listed lighting and appliance (CTL) panelboards **cannot** exceed 42 electrically connected circuits in a single enclosure.
3. When bare copper is specified, use the silver-plated groups.
4. **Order breakers separately with connector kit.**

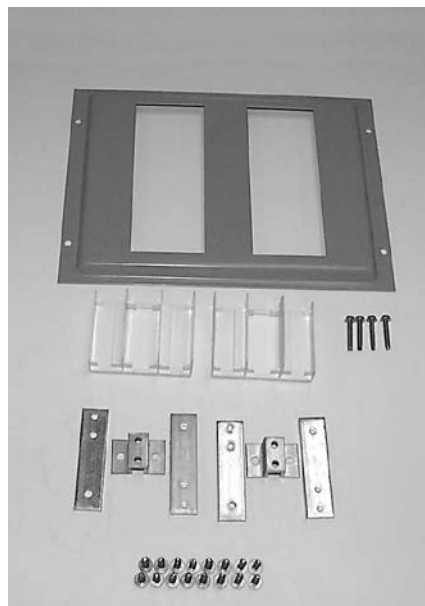

1C96608G01

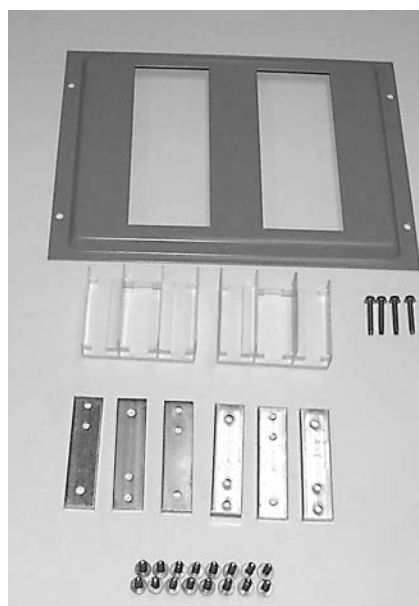

1C96608G05

Table 8. Plug-in QUICKLAG breaker assemblies

Breaker frame	Drawing number ①	Branch circuit quantity	Three-phase		Single-phase	
			Tin-plated aluminum connector	Silver-plated copper connector	Tin-plated aluminum connector	Silver-plated copper connector
			Item number			
HQP, QPHW, QHPX, QPGF, QPHGF, QPGFEP, QPHGFEP	2C11642	12	—	G03	—	G07
		18	—	G11	—	G15
		30	—	G19	—	G23
		42	—	G27	—	G31
		48	—	G35	—	G39
		54	—	G43	—	G47
		72	—	G51	—	G55
		96	—	G59	—	G63

① Order the basic drawing number, along with the equivalent G-number that's needed.

Note: When determining branch circuit quantity, remember:

1. QUICKLAG breakers with shunt trips require one additional circuit.
2. UL listed lighting and appliance (CTL) panelboards **cannot** exceed 42 electrically connected circuits in a single enclosure.
3. When aluminum is specified, use the silver-plated groups.
4. The sum of the horizontally twin-mounted breakers **shall not exceed 140 A**.
5. **Order breakers separately with connector kit.**

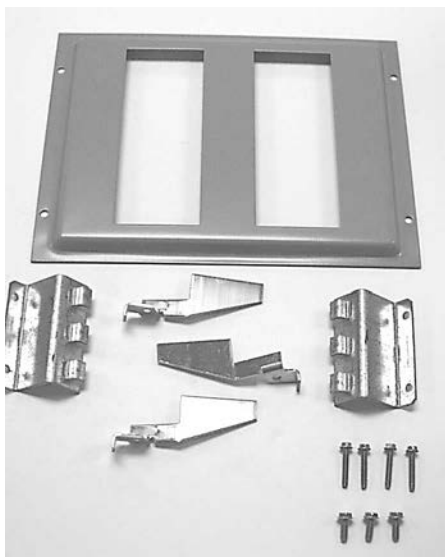

2C11642G03



2C11642G07

Table 9. GB, GHB, GHQ, GHBS breaker assemblies

Breaker frame	Drawing number ①	Branch circuit quantity	Three-phase		Single-phase	
			Tin-plated aluminum connector Item number	Silver-plated copper connector	Tin-plated aluminum connector	Silver-plated copper connector
GB, GHB, GHQ, GHBS	1C96609	12	G01	G03	G05	G07
		18	G09	G11	G13	G15
		30	G17	G19	G21	G23
		42	G25	G27	G29	G31
		48	G33	G35	G37	G39
		54	G41	G43	G45	G47
		72	G49	G51	G53	G55
		96	G57	G59	G61	G63

① Order the basic drawing number, along with the equivalent G-number that's needed.

Note: When determining branch circuit quantity, remember:

1. QUICKLAG breakers with shunt trips require one additional circuit.
2. UL listed lighting and appliance (CTL) panelboards **cannot** exceed 42 electrically connected circuits in a single enclosure.
3. When bare copper is specified, use the silver-plated groups.
4. **Order breakers separately with connector kit.**

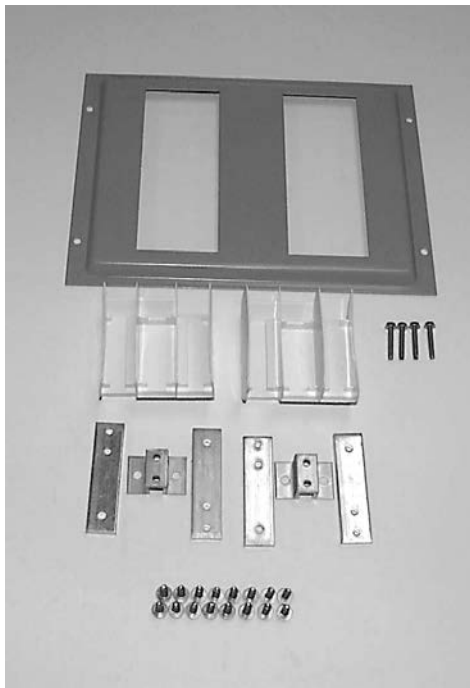

1C96609G01

PRL1a, 2a neutral assemblies

Table 10. 100 A neutral assemblies ①

Panel main bus ampere rating	Neutral rating	Lug type	Drawing number ②	Panel lug options ③	Wire size range	Quantity	Tin-plated aluminum connector Item number	Silver-plated copper connector
100	100%	Mechanical	1C96646	STD	#14-1/0	1	G02	G03
				SFL/TFL	#14-1/0	2	G05	G07
				OVS	#6-300 kcmil	1	G09	G11
		Crimp	42C4050	STD	#1-1/0	1	G01	G03
				SFL/TFL	#1-1/0	2	G05	G07
				OVS	2/0-300 kcmil	1	G09	G11
		Copper	1C96648	STD	#14-1/0	1	—	G03
				SFL/TFL	#14-1/0	2	—	G07
				OVS	#6-250 kcmil	1	—	G11
	200%	Mechanical	1C96649	STD	#6-300 kcmil	1	G02	G03
				SFL/TFL	#6-300 kcmil	2	G06	G07
				OVS	4/0-500 kcmil	1	G09	G11
		Crimp	42C4051	STD	2/0-300 kcmil	1	G01	G03
				SFL/TFL	2/0-300 kcmil	2	G05	G07
				OVS	4/0-500 kcmil	1	G09	G11
Copper	1C96651	STD	#6-250 kcmil	1	—	G03		
		SFL/TFL	#6-250 kcmil	2	—	G07		
		OVS	1/0-600 kcmil	1	—	G11		

① The assemblies shown on this page are for panelboards that mount in 30.00-90.00-inch (762.0-2286.0 mm) high enclosures only. Reference **page 14** for assemblies for panelboards that mount in 21.00-27.00-inch (533.4-685.8 mm) high enclosures.

② Order the basic drawing number, along with the equivalent G-number that's needed.

③ STD = Standard lugs.
 SFL/TFL = Sub-feed and through-feed lugs.
 OVS = Oversize lugs.



1C96646G01

Effective October 2017

Table 11. 225 A neutral assemblies ①

Panel main bus ampere rating	Neutral rating	Lug type	Drawing number ②	Panel lug options ③	Wire size range	Quantity	Tin-plated aluminum connector Item number	Silver-plated copper connector
225	100%	Mechanical	1C96649	STD	#6–300 kcmil	1	G02	G03
				SFL/TFL	#6–300 kcmil	2	G06	G07
				OVS	4/0–500 kcmil	1	G09	G11
		Crimp	42C4051	STD	2/0–300 kcmil	1	G01	G03
				SFL/TFL	2/0–300 kcmil	2	G05	G07
				OVS	4/0–500 kcmil	1	G09	G11
		Copper	1C96651	STD	#6–250 kcmil	1	—	G03
				SFL/TFL	#6–250 kcmil	2	—	G07
				OVS	1/0–600 kcmil	1	—	G11
	200%	Mechanical	1C96652	STD	4/0–500 kcmil	2	G01	G03
				SFL/TFL	—	—	G05	G07
				OVS	3/0–750 kcmil	2	G09	G11
		Crimp	42C4052	STD	4/0–500 kcmil	2	G01	G03
				SFL/TFL	—	—	G05	G07
				OVS	500–750 kcmil	2	G09	G11
		Copper	1C96654	STD	1/0–600 kcmil	1	—	G03
				SFL/TFL	—	—	—	G07
				OVS	1/0–600 kcmil	1	—	G11

① The assemblies shown on this page are for panelboards that mount in 30.00–90.00-inch (762.0–2286.0 mm) high enclosures.

② Order the basic drawing number, along with the equivalent G-number that's needed.

③ STD = Standard lugs.
SFL/TFL = Sub-feed and through-feed lugs.
OVS = Oversize lugs.



1C96649G01

Table 12. 400 A neutral assemblies ①

Panel main bus ampere rating	Neutral rating	Lug type	Drawing number ②	Panel lug options ③	Wire size range	Quantity	Tin-plated aluminum connector	Silver-plated copper connector
							Item number	
400	100%	Mechanical	1C96652	STD	4/0–500 kcmil	2	G01	G03
				SFL/TFL	—	—	G05	G07
				OVS	3/0–750 kcmil	2	G09	G11
		Crimp	42C4052	STD	4/0–500 kcmil	2	G01	G03
				SFL/TFL	—	—	G05	G07
				OVS	500–750 kcmil	2	G09	G11
		Copper	1C96654	STD	1/0–600 kcmil	1	—	G03
				SFL/TFL	—	—	—	G07
				OVS	1/0–600 kcmil	1	—	G11

① The assemblies shown on this page are for panelboards that mount in 30.00–90.00-inch (762.0–2286.0 mm) high enclosures.

② Order the basic drawing number, along with the equivalent G-number that's needed.

③ STD = Standard lugs.
SFL/TFL = Sub-feed and through-feed lugs.
OVS = Oversize lugs.

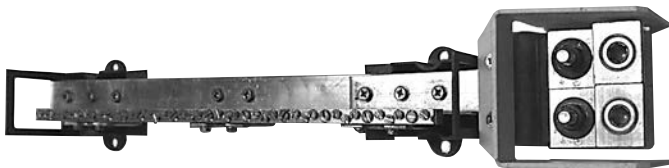

1C96652G01

Table 13. 600 A neutral assemblies ①

Panel main bus ampere rating	Neutral rating	Lug type	Drawing number ②	Circuit quantity	Panel lug options ③	Tin-plated aluminum connector	Bare copper	Silver-plated copper connector	Tin-plated copper connector			
						Item number						
600	100%	Mechanical	1C96652	42 or less	STD	—	G02	G03	G04			
					TFL	—	G06	G07	G08			
					OVS	—	G10	G11	G12			
					OVS W/ TFL	—	G26	G27	G28			
					Anderson	—	42 or less	STD	—	—	—	—
								TFL	—	—	—	
								OVS	—	—	—	
					Burndy	42C4052	42 or less	STD	—	G02	G03	G04
								TFL	—	G06	G07	G08
		OVS	—	G10				G11	G12			
		Copper	—	42 or less	STD	—	—	—	—			
					TFL	—	—	—				
					OVS	—	—	—				
					Greater than 42	STD	—	—	—			
						TFL	—	—	—			
OVS	—					—	—					

① The assemblies shown on this page are for panelboards that mount in 30.00–90.00-inch (762.0–2286.0 mm) high enclosures.

② Order the basic drawing number, along with the equivalent G-number that's needed.

③ STD = Standard lugs.
SFL/TFL = Sub-feed and through-feed lugs.
OVS = Oversize lugs.

Effective October 2017

Table 14. 100 A neutral assemblies for 21.00–27.00-inch (533.4–685.8 mm) high enclosures only ①

Panel main bus ampere rating	Neutral rating	Lug type	Drawing number ②	Panel lug options ③	Wire size range	Quantity	Tin-plated aluminum connector	Silver-plated copper connector	
							Item number		
100	100%	Mechanical	1C96645	STD	#14–1/0	1	G01	G03	
				SFL/TFL	#14–1/0	2	G05	G07	
				OVS	—	—	—	—	
		Crimp	—	STD	—	—	—	—	—
			SFL/TFL	—	—	—	—	—	—
			OVS	—	—	—	—	—	—
	Copper	—	STD	—	—	—	—	—	
		SFL/TFL	—	—	—	—	—	—	
		OVS	—	—	—	—	—	—	
	200%	Mechanical	1C97022	STD	#6–300 kcmil	1	G01	G03	
				SFL/TFL	#6–300 kcmil	2	G05	G07	
				OVS	—	—	—	—	
Crimp		—	STD	—	—	—	—	—	
		SFL/TFL	—	—	—	—	—	—	
		OVS	—	—	—	—	—	—	
Copper		—	STD	—	—	—	—	—	
		SFL/TFL	—	—	—	—	—	—	
		OVS	—	—	—	—	—	—	

① The assemblies shown on this page are for panelboards that mount in 21.00–27.00-inch (533.4–685.8 mm) high enclosures only. Reference **page 11** for assemblies for panels that mount in 36.00, 48.00, 60.00, 72.00, and 90.00-inch (914.4, 1219.2, 1524.0, 1828.8, and 2286.0 mm) high enclosures.

② Order the basic drawing number, along with the equivalent G-number that's needed.

③ STD = Standard lugs.
 SFL/TFL = Sub-feed and through-feed lugs.
 OVS = Oversize lugs.



1C96645G01

PRL1a, 2a ground assemblies

Table 15. Standard ground

Drawing number ①	Enclosure height in inches (mm)	Bar material	Item number
5158C05	24.00 (609.6)	Aluminum/copper	G01
		Copper	G03
	36.00 (914.4), 48.00 (1219.2), 60.00 (1524.0), 72.00 (1828.8), 90.00 (2286.0)	Aluminum/copper	G02
		Copper	G04

① Order the basic drawing number, along with the equivalent G-number that's needed (example: 5158C05G01).



5158C05G01



5158C05G02

Table 16. Isolated ground

Drawing number ①	Enclosure height in inches (mm)	Bar material	Item number
2C11296	24.00 (609.6)	Aluminum/copper	G01
		Copper	G02
	36.00 (914.4), 48.00 (1219.2), 60.00 (1524.0), 72.00 (1828.8), 90.00 (2286.0)	Aluminum/copper	G03
		Copper	G04

① Order the basic drawing number, along with the equivalent G-number that's needed (example: 5158C05G01).

PRL1a, 2a service entrance bonding jumper kits

Table 17. PRL1a, 2a service entrance bonding jumper kits

Drawing number ①	Panel ampere rating	Tin-plated aluminum	Bare copper	Silver-plated copper	Tin-plated copper
Mechanical main lugs or main breakers					
4180B62	100–225	G01	G02	G03	G04
4180B62	400–600	G05	G06	G07	G08
Compression (crimp) main lugs					
4180B62	100–225	G09	G10	G11	G12
4180B62	400–600	G13	G14	G15	G16
Copper main lugs					
4180B62	100–225	—	G18	G19	G20
4180B62	400–600	—	G22	G23	G24

① Order the basic drawing number, along with the equivalent G-number that's needed (example: 5158C05G01).



4180B62G01

PRL1a, 2a service entrance main breaker kits

Table 18. PRL1a, 2a service entrance main breaker kits

Description	Circuit breaker frame	Catalog number
Service entrance barrier for LG and KD	LG/KD	PRLSEBLGKD
Service entrance barrier for JD	JD	PRLSEBJD
Service entrance barrier for FD	FD	PRLSEBFD
Service entrance barrier for GHB	GHB	PRLSEBGB



SE barrier kit FD_016

Effective October 2017

PRL1a, 2a deadfront covers

Note: Does not apply to PRL4 sub-chassis.

Table 19. Assembly

Assembly drawing number ①	Standard enclosure height in inches (mm)						
	24.00 (609.6)	36.00 (914.4)	42.00 (1066.8)	48.00 (1219.2)	60.00 (1524.0)	72.00 (1828.8)	90.00 (2286.0)
1C96638	G01	G02	G07	G03	G04	G05	G06

① Order the basic drawing number, along with the equivalent G-number that's needed (example: 1C96638G01).



1C96638G01

Table 20. Vertically mounted devices

Mounting arrangement	Device/frame	Drawing number ①	Mounting position	Item number
Vertical	100 A MLO, SFL, TFL or F-Frame (100 A maximum)	4180B03	Top	H01
			Bottom	H01
	225 A MLO, SFL, TFL or F-Frame (225 A maximum)	4180B61	Top	H01
			Bottom	H01
	400 A MLO, SFL, TFL or J-Frame	4180B04	Top	H01
			Bottom	H02
	400 A MLO, TFL or K-Frame	4180B05	Top	H01
			Bottom	H02
Blank covers in inches (mm)	1.00 (25.4)	4180B08	—	H01
	2.00 (50.8)		—	H02
	3.00 (76.2)		—	H03
	4.00 (101.6)		—	H04
	5.00 (127.0)		—	H05
	6.00 (152.4)		—	H06
	7.00 (177.8)		—	H07
	8.00 (203.2)		—	H08
	9.00 (228.6)		—	H09
	10.00 (254.0)		—	H10
	11.00 (279.4)		—	H11
	12.00 (304.8)		—	H12
	13.00 (330.2)		—	H13
	14.00 (355.6)		—	H14
	15.00 (381.0)		—	H15
	16.00 (406.4)		—	H16

① Order the basic drawing number, along with the equivalent H-number that's needed (example: 4180B03H01).



4180B08H03

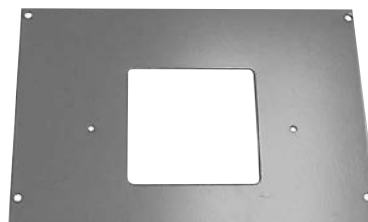

4180B03H01

Table 21. Horizontally mounted devices

Mounting arrangement	Device/frame	Drawing number ①	Branch circuit quantity	Item number	Quantity required		
Horizontal	BA, BAB, QBH, QBGF, QBHGF, QBGFEP, QBHGFEP	1C96619	12	H01	1		
			18	H02	1		
			30	H04	1		
			42	H06	1		
			48	H03	2		
			54	H03 and H04	1 each		
			72	H05	2		
			96	H07	2		
			GB, GHB, GHQ, GHBS	1C96620	12	H01	1
					18	H02	1
					30	H04	1
					42	H06	1
					48	H03	2
					54	H03 and H04	1 each
72	H05	2					
96	H07	2					

① Order the basic drawing number, along with the equivalent H-number that's needed (example: 1C96619H01).

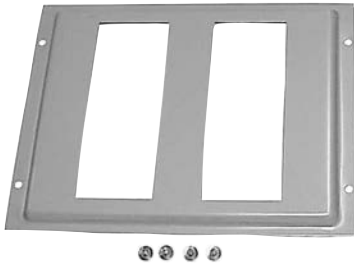

1C96619H01



1C96620H01

Table 22. Filler covers

Device/frame	Drawing number	Item number
F, J, K ①	4180B52	H01
QUICKLAG, GB, GHB ②	5155C62	H01

① Filler covers are required in addition to deadfront cover whenever MLO, SFL or TFL are specified.

② Filler covers are required in addition to deadfront cover whenever a branch provision is specified.



5155C62H01



4180B52H01

Panelboard special trim locks

Panelboard trims use different trim locks. See pictures below for styles and part numbers. Contact your nearest satellite for availability on the styles listed below. See **page 3** for satellite listings.

Table 23. Panelboard special trim locks

Description	Catalog number
For use on left-handed door (hinged on left side)	K80522
For use on right-handed door (hinged on right side)	K80133
T-Handle lock, at one time used on all trims over 48.00 inches (1219.2 mm) in height Also used on outdoor NEMA® 12/3R trims	K80429
Used on PRL4 lighting and power panels as standard	1A32258H03
Used on PRL1, 2, 3 and PRL1a, 2a, 3a lighting panels as standard; WEM 2 key	5155C81G01

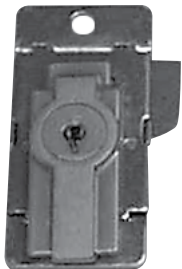

K80522

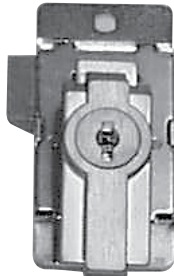

K80133



5155C81G01

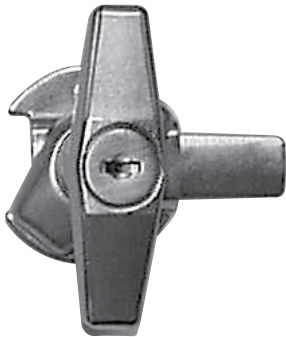

K80429

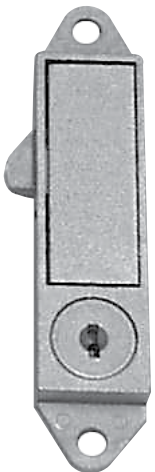

1A32258H03

Panelboard EZ trim locks

Panelboard EZ trims use different trim locks. See **Table 24** and pictures below for styles and part numbers. Contact your nearest satellite for availability. See **page 3** for satellite listings.

Table 24. Panelboard EZ trim locks

Description	Size	Catalog number
Lock	24–48 inches	5155C81G03
Lock and latch	54–60 inches	5155C81G03/5155C81G05
Lock and latch	72–90 inches	5155C81G04/5155C81G06



EZ trim lock with key



EZ trim latch without key

Panelboard Fastrim clamps and screw-on hardware kits

For panelboard trim clamps, contact your nearest satellite for availability on the styles listed below. See **page 3** for satellite listings.

Table 25. Panelboard Fastrim clamps and screw-on hardware kits

Description	Style number
Trim clamps—used on PRL1a, 2a, 3a Fastrims (6 per bag)	2C11641G02
Trim screws—used on PRL1a, 2a, 3a, 4B standard trim (10 per bag)	5157C83G06
Chassis mounting hardware bag—PRL1a, 2a, 3a panels	7499A48G04

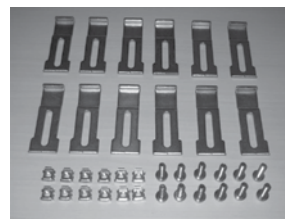

2C11641G02



5157C83G06



7499A48G04

PRL3a parts section

Description	Page
Connector kit assemblies	19
Ground assemblies	20
Service entrance kits	20
Deadfront covers	20–22

PRL3a horizontally mounted connector kit assemblies

Three-phase kits contain A, B, and C phase connectors. Single-phase kits contain A and C phase connectors, deadfront cover, hardware and instructions to twin-mount breakers across from each other. **Maximum amperes connected to any one connector cannot exceed 200 A.**

Table 26. Connector kit assemblies

Devices	Circuits or pole	Three-phase		Single-phase		Notes
		Catalog number	Phase	Catalog number	Phase	
BA, BAB, QBGF, QBH, QBHGF, QBGFEP, QBHGFEP	6	KPRL3ABA06	A/B/C	KPRL3ABA06-1	A/C	(2) 100 A devices maximum
	12	KPRL3ABA12	A/B/C	KPRL3ABA12-1	A/C	
	18	KPRL3ABA18	A/B/C	KPRL3ABA18-1	A/C	
	24	KPRL3ABA24	A/B/C	KPRL3ABA24-1	A/C	
GB, GHB, GHQ, GHBS	6	KPRL3AGB06	A/B/C	KPRL3AGB06-1	A/C	
	12	KPRL3AGB12	A/B/C	KPRL3AGB12-1	A/C	
	18	KPRL3AGB18	A/B/C	KPRL3AGB18-1	A/C	
	24	KPRL3AGB24	A/B/C	KPRL3AGB24-1	A/C	

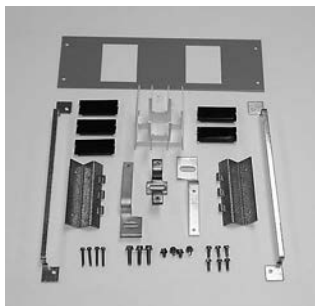

KPRL3ABA06

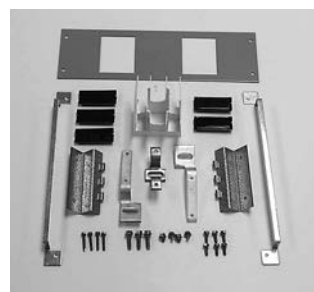

KPRL3AGB06

PRL3a F-Frame horizontally mounted connector kit assemblies

Connector kits contain phase connectors, deadfront cover, hardware, and instructions to mount breakers. Order breakers separately when ordering connector kit.

Table 27. Connector kit assemblies

Devices	Circuits or pole	Three-phase		Single-phase		Notes
		Catalog number	Phase	Catalog number	Phase	
EHD, FD, FDB, HFD, FDC (150 A maximum twin mount)	Three-pole breaker	KPRL3AFD3	A/B/C	—	—	(2) 150 A devices maximum
	Two-pole breaker	KPRL3AFD2	A/C	KPRL3AFD2	A/C	
	Single-pole breaker	KPRL3AFD1	A/C	KPRL3AFD1	A/C	
FD, HFD, FDC, ED, EDH, EDC (175–225 A single mount) Ⓞ	Three-pole breaker	KPRL3AED3	A/B/C	—	—	(1) 225 A maximum single mounted
	Two-pole breaker	KPRL3AED2	A/C	KPRL3AED2	A/C	

Ⓞ F-Frame devices rated above 150 A must be single mounted. No twin mounting acceptable.

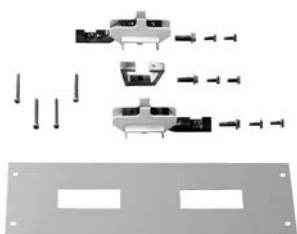

KPRL3AFD3

PRL3a ground assemblies

Table 28. PRL3a ground assemblies

Material	Standard	Isolated
	Catalog number	
Aluminum/copper	5158C05G02	2C11296G02
Copper only	5158C05G04	2C11296G04



5158C05G02

PRL3a service entrance bonding jumper kits

Table 29. PRL3a service entrance bonding jumper kits

Style number ①	Panel ampere rating	Tin-plated aluminum	Bare copper	Silver-plated copper	Tin-plated copper
		Item number			
Mechanical main lugs or main breakers					
5078A98	100	G01	G02	G03	G04
	250–600	G13	G14	G15	G16
Crimp main lugs					
5078A98	100	G05	G06	G07	G08
	250–600	G17	G18	G19	G20
Copper main lugs					
5078A98	100	G09	G10	G11	G12
	250–600	G21	G22	G23	G24

① When ordering, use complete style number (example: 100 A tin-plated aluminum 5078A98G01).



5078A98G01

PRL3a service entrance main breaker kits

Table 30. PRL3a service entrance main breaker kits

Description	Circuit breaker frame	Catalog number
Service entrance barrier for LG and KD	LG/KD	PRLSEBLGKD
Service entrance barrier for JD	JD	PRLSEBJD
Service entrance barrier for FD	FD	PRLSEBFD
Service entrance barrier for GHB	GHB	PRLSEBGHB



SE Barrier Kit FD_016

PRL3a deadfront covers

Table 31. Assembly ①

Style number ②	Chassis height/item number				
	14X	23X	31X	40X	53X
6559C59	G01	G02	G03	G04	G05

① Assembly groups include the frame only (two rails and two end covers). Reference page 22 for specific device covers. All connector kits ship with a deadfront cover for that device.

② When ordering, use complete style number (example: 14X high assembly 6559C59G01).



6559C59G01

PRL3a vertical devices deadfront covers**Table 32. Vertical mounting position**

Device/frame	Trip unit type	Style number ①	"X" space required	Item number	
				Without lock-offs ①	With lock-offs ①
EHD, FD, FDB, HFD, FDC, ED, EDH, EDC (top) ②	—	4176B68	7X	H01	H03
EHD, FD, FDB, HFD, FDC, ED, EDH, EDC (bottom) ②	—		7X	H04	H05
FD, HFD, FDC, ED, EDH (top) ③	—	4180B93	10X	H01	H03
FD, HFD, FDC, ED, EDH (bottom) ③	—		10X	H04	H05
J-Frame (bottom)	—	4176B60	14X	H01	H02
J-Frame (top)	—		14X	H03	H04
K-Frame (bottom)	Thermal-mag.	4176B61	15X	H01	H02
K-Frame (bottom)	Electronic		15X	H03	H04
K-Frame (top)	Thermal-mag.		15X	H05	H06
K-Frame (top)	Electronic		15X	H07	H08
L-Frame (bottom)	Thermal-mag.	4176B51	17X	H01	H02
L-Frame (bottom)	Electronic		17X	H03	H04
L-Frame (top)	Thermal-mag.		17X	H05	H06
L-Frame (top)	Electronic		17X	H07	H08
FB-P (top only)	—	4176B70	9X	H02	H02
LA-P (top only)	—	4176B57	21X	H01	H01
FCL	—	4176B70	9X	H01	H01
LCL (top)	—	4176B56	21X	H01	H02
LCL (bottom)	—		21X	H03	H04
Neutral/blank cover	—	4176B72	1X	H01	—
			2X	H02	
			3X	H03	
			4X	H04	
			5X	H05	
			6X	H06	
			7X	H07	
			8X	H08	
			9X	H09	
			10X	H10	
			11X	H11	
			12X	H12	
J-Frame sub-feed twin bottom	—	4176B79	20X	H01	H02 (2 L/O) H03 (1 L/O RT) H04 (1 L/O LT)
J-Frame sub-feed twin top	—	4176B79	20X	H05	H05 (2 L/O) H07 (1 L/O RT) H08 (1 L/O LT)
PT363 (top)	—	4180B79	7X	H01	—
PT363 (bottom)	—		7X	H02	
PT364 (top)	—		9X	H03	
PT364 (bottom)	—		9X	H04	

① When ordering covers, order complete style and item numbers (example: 4176B68H01).

② 4/0 maximum acceptable terminal size.

③ 300 kcmil maximum acceptable terminal size.



J main 4176B60H04



Neutral blank cover 4176B72H04

Effective October 2017

PRL3a horizontal devices deadfront covers**Table 33. Horizontal mounting position**

Device/frame	Device poles	Style number ①	Total circuit quantity	"X" space required	Item number
EHD, FD, FDB, FDC (twin mounted)	1, 2 or 3	4178B08	6	3X	H01
			12	6X	H02
			18	9X	H03
			24	12X	H04
			30	15X	H05
			36	18X	H06
			42	21X	H07
			48	24X	H08
EHD, FD, FDB, HFD, FDC (twin mounted)	1 or 2	4179B39	4	2X	H01
			8	4X	H02
			12	6X	H03
			16	8X	H04
			20	10X	H05
			24	12X	H06
			28	14X	H07
			32	16X	H08
EHD, FD, FDB, HFD, FDC (twin mounted)	1	4179B40	2	1X	H01
FD, HFD, FDC, ED, EDH, EDC (single mounted)	3	4179B41	3	3X	H01
FD, HFD, FDC, ED, EDH, EDC (single mounted)	2	4179B42	2	2X	H01
CA, CAH, HCA	3	4176B66	3	3X	H01
CA, CAH, HCA	2	4176B80	2	2X	H01
BA, BAB, BABRP, BABRSP QBH, QBGF, QBGFEP, QBHGFEP	1, 2 or 3	4176B67	6	3X	H01
			12	5X	H02
			18	8X	H03
			24	10X	H04
GB, GHB, GHBS, GHBGFEP, HGHB, GHQ	1, 2 or 3	4176B69	6	3X	H01
			12	5X	H02
			18	8X	H03
			24	10X	H04
Pow-R-Command Controller	—	4180B91	—	5X	H01
Pow-R-Command Expansion	—	4180B91	—	7X	H02
				16X	H03

① When ordering covers, order complete style and item number (example: 4178B08H01).

PRL3a deadfront cover blank fillers**Table 34. PRL3a deadfront cover blank fillers**

Device/frame	Poles	Style number
F-Frame	1, 2 or 3	4178B06H01
C-Frame	2	6555C40H01
C-Frame	3	6555C41H01
QUICKLAG, GB, GHB, GHBS	1, 2 or 3	5155C62H01



BAB Cover 4176B67H01

PRL4 parts section

Description	Page
Vented cover assemblies	23
Blank covers	24
Breaker connector kits	24
Fusible connector kits	25
Breaker and fusible switch retrofit kits	26–27
PRL1a, 2a, 3a EZ trims and enclosures	27
PRL4 special trims and enclosures	29
Type 12/3R enclosures	30

PRL4 vented cover assemblies

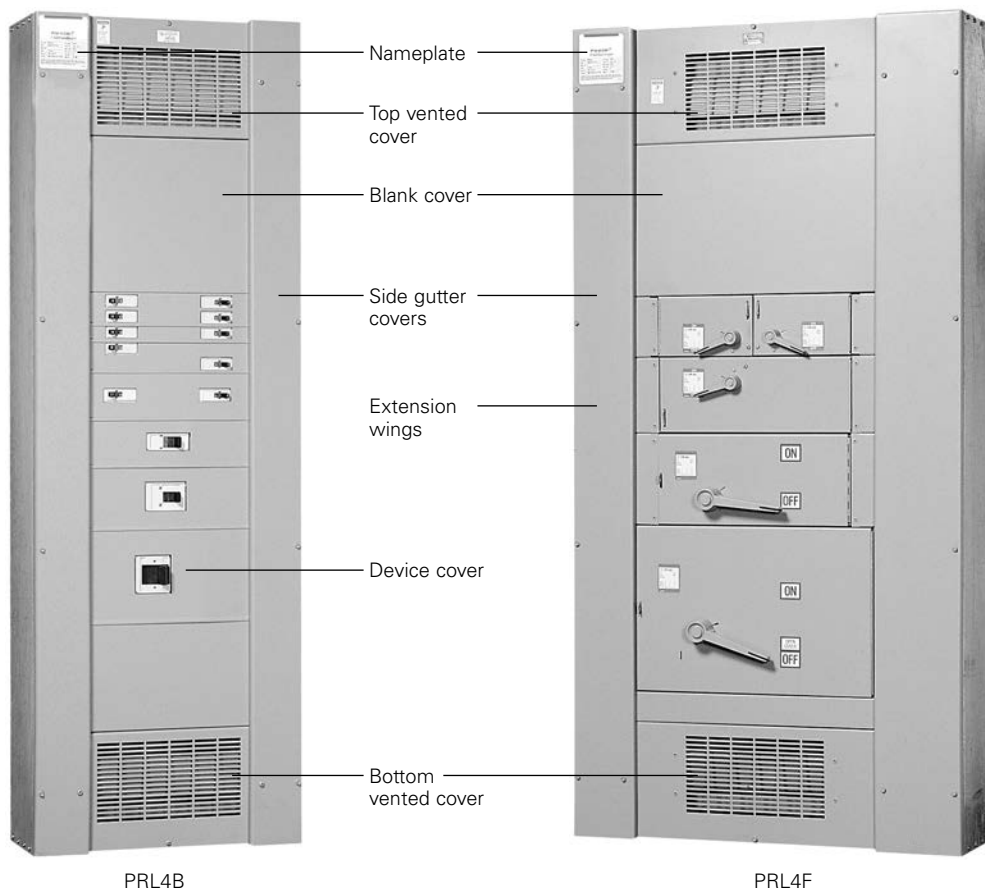

Table 35. Vented cover assemblies and side gutter covers—dimensions in inches (mm)

NEMA 1 box					Side gutter covers			
Height	Width	Depth ①	Catalog number	Vented cover assembly style number ②	Left		Right	
					Size	Style number	Size	Style number
57.00 (1447.8)	24.00 (609.6)	10.40 (264.2)	BX2457	6574C74G02	5.00 (127.0) x 57.00 (1447.8)	6555C20H01	5.00 (127.0) x 57.00 (1447.8)	6555C20H01
73.00 (1854.2)	24.00 (609.6)		BX2473	6574C74G03	5.00 (127.0) x 73.00 (1854.2)	6555C21H01	5.00 (127.0) x 73.00 (1854.2)	6555C21H01
90.00 (2286.0)	24.00 (609.6)		BX2490	6574C74G04	5.00 (127.0) x 90.00 (2286.0)	6555C25H01	5.00 (127.0) x 90.00 (2286.0)	6555C25H01
73.00 (1854.2)	36.00 (914.4)		BX3673	6574C74G05	6.00 (152.4) x 73.00 (1854.2)	6555C22H01	8.00 (203.2) x 73.00 (1854.2)	6555C23H01
90.00 (2286.0)	36.00 (914.4)		BX3690	6574C74G06	6.00 (152.4) x 90.00 (2286.0)	6555C26H01	8.00 (203.2) x 90.00 (2286.0)	6555C27H01
73.00 (1854.2)	44.00 (1117.6)		BX4473	6574C74G05	8.00 (203.2) x 73.00 (1854.2)	6555C23H01	14.00 (355.6) x 73.00 (1854.2)	6555C24H01
90.00 (2286.0)	44.00 (1117.6)		BX4490	6574C74G06	8.00 (203.2) x 90.00 (2286.0)	6555C27H01	14.00 (355.6) x 90.00 (2286.0)	6555C28H01

① Covers add 0.90 inches (22.9 mm) to box depth for overall enclosure depth of 11.30 inches (287.0 mm).

② Cover assembly consists of two side rails, top and bottom vented covers. **Important:** Order individual device covers and blanks separately.

PRL4 blank covers

Used to cover blank space on chassis. All PRL4 cover heights are measured in "X" units. 1X equals 1.38 inches (35.1 mm).

Table 36. PRL4 blank covers

Cover size	Style number	
	24.00-inch (609.6 mm) width box	36.00, 44.00-inch (914.4, 1117.6 mm) width box
1X	6554C01H01	6554C02H01
2X	6554C01H02	6554C02H02
3X	6554C01H03	6554C02H03
4X	6554C01H13	6554C02H13
5X	6554C01H14	6554C02H14
6X	6554C01H04	6554C02H04
7X	6554C01H05	6554C02H05
9X	6554C01H06	6554C02H06
10X	6554C01H07	6554C02H07
11X	6554C01H08	6554C02H08
12X	6554C01H09	6554C02H09
13X	6554C01H10	6554C02H10
15X	6554C01H11	6554C02H11
20X	6554C01H12	6554C02H12

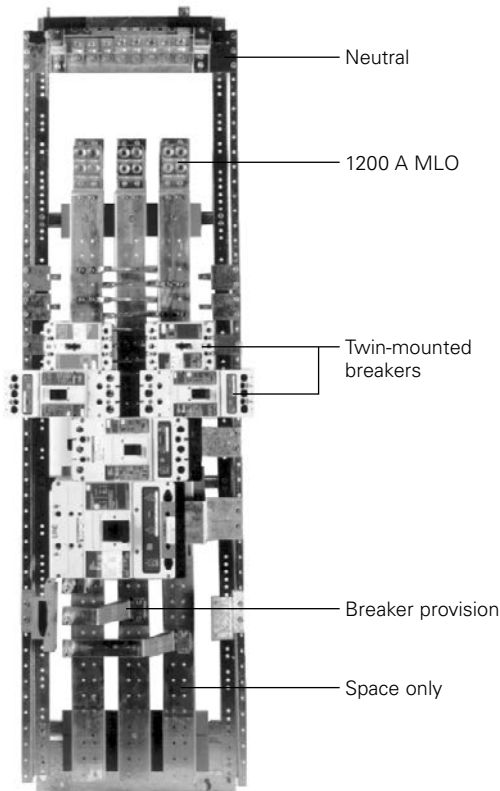

PRL4B Interior

PRL4 breaker connector kits

Breaker connector kits

Each kit includes copper connectors, mounting brackets, covers, hardware, and instructions for mounting breaker(s) in a PRL4.

Breakers are not included. Contact your local satellite plant for availability and application information (see **page 3**).

Connector kit

Each kit includes copper connectors mounting brackets, cover, hardware, and instructions.

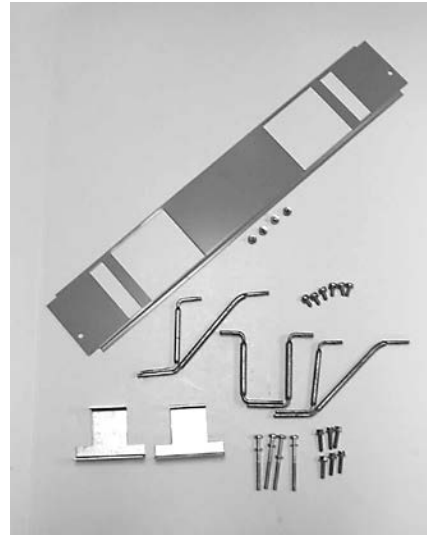

Connector kit

Table 37. Breaker connector kits

Breaker frame	Space required		Poles	Mounting type	Connector kit catalog number
	Inches (mm)	"X"			
EHD, FD, HFD	2.75 (69.9)	2X	1 ①	Twin	KPRL4FD1
EHD, FD, FDB, HFD, FDC			2	Twin	KPRL4FD2
ED, EDH, EDC			2	Twin	KPRL4ED2
EHD, FD, FDB, HFD, FDC	4.13 (104.9)	3X	3	Twin	KPRL4FD
FCL, FB-P, FD/LFD			3	Twin	KPRL4FBP
ED, EDH, EDC			3	Twin	KPRL4ED
JD, JDB, HJD, JDC			2, 3	Single	KPRL4JDS
JD, JDB, HJD, JDC			2, 3	Twin	KPRL4JDT ②
DK, KD, KDB, HKD, KDC	5.50 (139.7)	4X	2, 3	Single	KPRL4KDS
DK, KD, KDB, HKD, KDC			2, 3	Twin	KPRL4KDT ③
CKD, CHKD			2, 3	Single	KPRL4CKD ④
LCL	8.25 (209.5)	6X	2, 3	Single	KPRL4LCL ②
LA-P			2, 3	Single	KPRL4LAP ②
LD, LDB, HLD, LDC, CLD, LC			2, 3	Single	KPRL4LD ②
MDL, HMDL			2, 3	Single	KPRL4MC ②
NB-P			2, 3	Single	KPRL4NBP ③
CND, CHND			3	Single	KPRL4CND ③④
ND, HND			2, 3	Single	KPRL4ND ②

① Two sets of twin-mounted single-pole breakers.

② 36.00-inch (914.4 mm) minimum box width required.

③ 44.00-inch (1117.6 mm) box width required.

④ Requires density rated bus in existing panel chassis.

Hardware kit

Each kit includes mounting bracket(s) and mounting hardware only. Use the appropriate connector kit catalog number and add an "H" to designate hardware only (example: KPRL4FD-H).

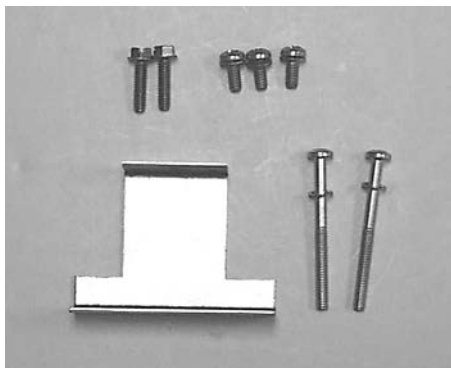

Hardware kit

Standard ground bus

Copper bus with (3) 6–300 kcmil lugs plus a 24-circuit terminal bar with #14–1/0 wire range.

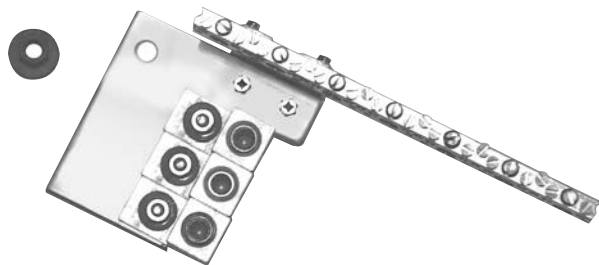

6572C746G01

PRL4 fusible connector kits

Fusible switch connector kits

Each kit includes copper connectors, extension wings (when required), hardware, and instructions to mount a fusible switch. Switches are not included. Contact your local satellite plant for availability and application information (see **page 3**).

Table 38. Fusible switch connector kits

Switch height Inches (mm)	"X" space required	Switch ampere rating	Three-pole switch		Connector kit
			240 V Catalog number	600 V Catalog number	
5.50 (139.7)	4X	30–30	FDPWT3211R	FDPWT3611R	—
		60–60	FDPWT3222R	FDPWT3622R	KPRL44X ①
		100–100	FDPWT3233R	—	—
6.88 (174.8)	5X	100–100	—	FDPWT3633R	KPRL45X1
8.25 (209.6)	6X	200	FDPBS324R	FDPBS364R	KPRL4B6XS
		200–200	FDPBT3244R	FDPBT3644R	KPRL4B6XT ②
12.38 (314.5)	9X	400	FDPW325R	FDPW365R	KPRL4W9X
15.13 (384.3)	11X	600	FDPW326R	FDPW366R	KPRL4W11X
		800	FDPW327	FDPW367	KPRL4W11X ②
20.63 (524.0)	15X	1200	FDPW328	FDPW368	KPRL4W15X ②

① These connector kits will fit the FDP and FDPW switches.

② 44.00-inch (1117.6 mm) box width required for both R and J fuse applications.

PRL4 breaker and fusible switch retrofit kits

Breaker retrofit kits

Each kit includes one breaker, copper connectors, covers, hardware, and instructions to mount in a PRL4.

Table 39. Breaker retrofit kits

Breaker frame	Frame ampere rating	Trip range	Mounting type
EHD	100	15–100	Twin
FDB		15–100	Twin
FD		15–100	Twin
HFD		15–100	Twin
FDC		15–100	Twin
FCL		15–100	Twin
FB-P		15–100	Twin
FDB	150	110–150	Twin
FD	225	110–225	Twin
HFD		110–225	Twin
FDC		110–225	Twin
ED		100–225	Twin
EDH		100–225	Twin
EDC		100–225	Twin
JD	250	70–250	Twin/single
HJD		70–250	Twin/single
JDC		70–250	Twin/single
DK	400	100–400	Twin/single
KD		100–400	Twin/single
HKD		100–400	Twin/single
KDC		100–400	Twin/single
CKD		100–400	Single
LCL		125–400	Single
LA-P		70–400	Single
LD	600	300–600	Single
CLD		300–600	Single
HLD		300–600	Single
CHLD		300–600	Single
LDC		300–600	Single
CLDC		300–600	Single
MDL	800	300–800	Single
CMDL		300–800	Single
HMDL		300–800	Single
CHMDL		300–800	Single
ND	1200	600–1200	Single
CND		600–1200	Single
HND		600–1200	Single
CHND		600–1200	Single
NDC		600–1200	Single
CNDC		600–1200	Single

How to order a breaker retrofit kit by catalog number

Use “KPRL4” prefix and add catalog number of breaker as shown below. Use suffix “T” or “S” to denote twin or single mounting. Twin-mounting indicates that one set of connectors is required to mount two breakers (of similar frames) opposite one another. Retrofit kit includes one breaker only, for either single or twin-mounted applications.

Table 40. Catalog numbering system—breaker retrofit kit

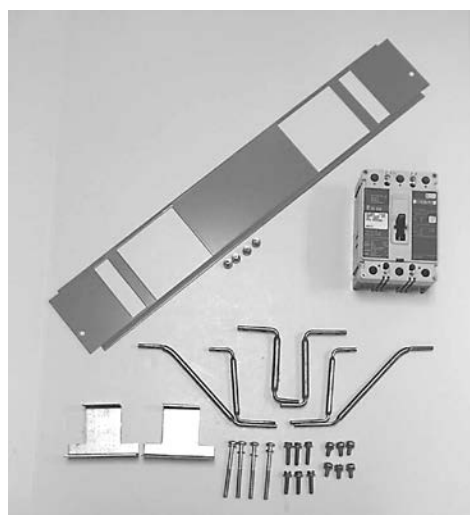
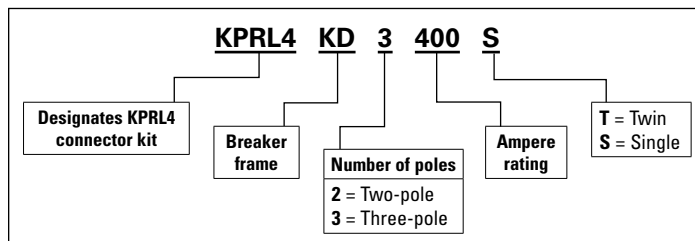

Breaker retrofit kit

Fusible retrofit kits

Each kit includes a three-pole switch, copper connectors, extension wings (if required), hardware, and instructions to horizontally mount in a PRL4.

Table 41. Fusible retrofit kits

Switch ampere rating	Switch type	Mounting type
30–30	FDPW	Twin
60–60	FDPW	Twin
100–100	FDPW	Twin
100	FDPW	Single
200	FDPB	Single
200–200	FDPB	Twin
400	FDPW	Single
600	FDPW	Single
800	FDPW	Single
1200	FDPW	Single

How to order a fusible retrofit kit by catalog number

Use “KPRL4” prefix and add catalog number of appropriate switch (refer to **page 26** for three-pole switch catalog number).

Example: The retrofit kit catalog number for a 600 V, 100 A twin FDPW switch is:

Table 42. Catalog numbering system—fusible retrofit kit

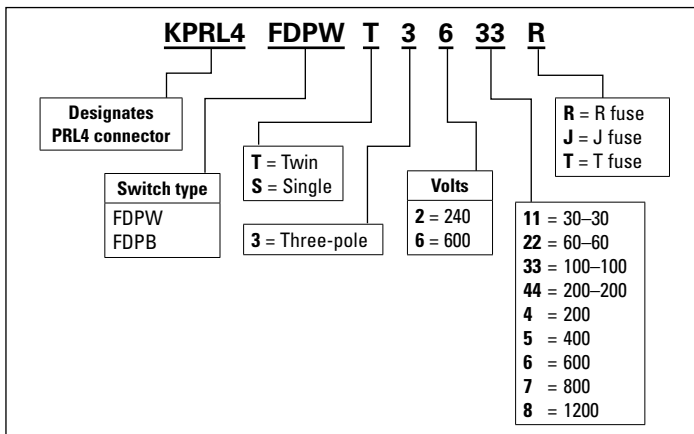

PRL1a, 2a, 3a EZ trims and enclosures

EZ trim

PRL1a, 2a, and PRL3a EZ trim and EZ box meet code requirements for both Type 1 standards. Features include a door-in-door standard with no exposed hardware and laser-cut trim with rounded corners. For EZ boxes and EZ trims, refer to **page 28**.

Example: EZT2048 and EZB2048.



EZ trim

Table 43. EZ trim

Encl. height	Box				Trim							
	Unpainted		Painted		Unvented surface mounted		Unvented flush mounted		Vented surface mounted		Vented flush mounted	
	Catalog number	Style number	Catalog number	Style number	Catalog number	Style number	Catalog number	Style number	Catalog number	Style number	Catalog number	Style number
24	EZB2024R	42C1999G01	EZBP2024R	42C1999G13	EZT2024S	42C4255G01	EZT2024F	42C4258G01	EZTV2024S	42C4261G01	EZTV2024F	42C4264G01
30	EZB2030R	42C1999G02	EZBP2030R	42C1999G14	EZT2030S	42C4255G02	EZT2030F	42C4258G02	EZTV2030S	42C4261G02	EZTV2030F	42C4264G02
36	EZB2036R	42C1999G03	EZBP2036R	42C1999G15	EZT2036S	42C4255G03	EZT2036F	42C4258G03	EZTV2036S	42C4261G03	EZTV2036F	42C4264G03
42	EZB2042R	42C1999G04	EZBP2042R	42C1999G16	EZT2042S	42C4255G04	EZT2042F	42C4258G04	EZTV2042S	42C4261G04	EZTV2042F	42C4264G04
48	EZB2048R	42C1999G05	EZBP2048R	42C1999G17	EZT2048S	42C4255G05	EZT2048F	42C4258G05	EZTV2048S	42C4261G05	EZTV2048F	42C4264G05
54	EZB2054R	42C1999G06	EZBP2054R	42C1999G18	EZT2054S	42C4255G06	EZT2054F	42C4258G06	EZTV2054S	42C4261G06	EZTV2054F	42C4264G06
60	EZB2060R	42C1999G07	EZBP2060R	42C1999G19	EZT2060S	42C4255G07	EZT2060F	42C4258G07	EZTV2060S	42C4261G07	EZTV2060F	42C4264G07
72	EZB2072R	42C1999G09	EZBP2072R	42C1999G21	EZT2072S	42C4255G09	EZT2072F	42C4258G09	EZTV2072S	42C4261G09	EZTV2072F	42C4264G09
90	EZB2090R	42C1999G12	EZBP2090R	42C1999G24	EZT2090S	42C4255G12	EZT2090F	42C4258G12	EZTV2090S	42C4261G12	EZTV2090F	42C4264G12

PRL1a, 2a, 3a special trims and enclosures

Fastrim

Used when concealed trim-mounting hardware is required for PRL1a, 2a, and PRL3a. Trim clamps are included and shipped with the trim. Order by adding the letter "F" to the standard trim catalog number. Add 20% to standard trim list price.

Example: LT2072S becomes **LTF2072S**.

For trim clamps only, refer to **page 18**.



Fastrim

Door-in-door

Piano hinge on the right side of the trim provides access to the wiring gutters without requiring removal of the trim. Order by adding the letters "DD" to the standard trim catalog number. Add 20% to standard trim list price.

Example: LT2072S becomes **LTDD2072S**.



Door-in-door

Ventilated trim

Required on 600 A and above panels only. Order by adding the letter "V" to the standard trim catalog number. Add 10% to standard trim list price.

Example: LT2072S becomes **LTV2072S**.



Ventilated trim

Type 12/3R enclosures

The complete enclosure consists of a box and trim. The enclosure meets code requirements for both Type 12 (dust-tight) and Type 3R (rainproof) standards. Features include a laser-cut trim with rounded corners, concealed hinges, and a T-handle lock. Gasketing is provided around the trim door.

The box is gasketed and made from code gauge steel with dripshield and is painted ANSI-61.

Table 44. Type 12/3R enclosures for PRL1a, 2a, 3a

Box dimensions in inches (mm)			Catalog number	
Height	Width	Depth	Box	Trim
24.00 (609.6)	20.00 (508.0)	6.00 (152.4)	VWPB2024	LWPT2024
36.00 (914.4)	20.00 (508.0)	6.00 (152.4)	VWPB2036	LWPT2036
48.00 (1219.2)	20.00 (508.0)	6.00 (152.4)	VWPB2048	LWPT2048
60.00 (1524.0)	20.00 (508.0)	6.00 (152.4)	VWPB2060	LWPT2060
72.00 (1828.8)	20.00 (508.0)	6.00 (152.4)	VWPB2072	LWPT2072
90.00 (2286.0)	20.00 (508.0)	6.00 (152.4)	VWPB2090	LWPT2090



Type 12/3R enclosures

PRL4 special trims and enclosures

Door-in-door trim



Door-in-door trim

A piano hinge on the right side of the trim provides access to the wiring gutter without requiring the removal of the trim. When used with a standard PRL4 box, a special mounting channel must be used to add extra depth to the enclosure.

An extra depth box, not requiring a mounting channel, is another available option. Contact your local satellite for ordering information.

Table 45. Special trims and enclosures

Standard box catalog number	Mounting channel style number	Door-in-door trim catalog number	
		Surface	Flush
BX2457	8708C82G02	LDD2457STW	LDD2457FTW
BX2473	8708C82G03	LDD2473STW	LDD2473FTW
BX2490	8708C82G04	LDD2490STW	LDD2490FTW
BX3673	8708C82G05	LDD3673STW	LDD3673FTW
BX3690	8708C82G06	LDD3690STW	LDD3690FTW
BX4473	8708C82G07	LDD4473STW	LDD4473FTW
BX4490	8708C82G08	LDD4490STW	LDD4490FTW

Type 12/3R enclosures



Type 12, 24.00 inches (609.6 mm) wide



Type 3R, 36.00 inches (914.4 mm) wide

PRL4 enclosures are available in both Type 12 (dust-tight) and Type 3R (rainproof) designs. The 24.00-inch (609.6 mm) wide enclosure includes a single hinged door while the 36.00-inch (914.4 mm) wide is provided with double hinged doors.

The side gutter covers are an integral part of the box in all styles. Sizes and catalog numbers are shown in **Table 46**.

Table 46. Type 12/3R enclosures

Enclosure dimensions in inches (mm)			Catalog number	
Height	Width	Depth	Type 3R	Type 12
57.00 (1447.8)	24.00 (609.6)	13.90 (353.1)	RPC2457	DPC2457
73.00 (1854.2)	24.00 (609.6)	13.90 (353.1)	RPC2473	DPC2473
90.00 (2286.0)	24.00 (609.6)	13.90 (353.1)	RPC2490	DPC2490
73.00 (1854.2)	36.00 (914.4)	13.90 (353.1)	RPC3673	DPC3673
90.00 (2286.0)	36.00 (914.4)	13.90 (353.1)	RPC3690	DPC3690

Ordering procedure

Step 1

Select the correct part or branch device. When selecting, you need to know the following:

- Panelboard type
- Amperage
- System voltage
- Available short-circuit rating
- Number of poles available
- Size and number of wires per phase
- "X" space required

Step 2

Refer to the 5P panelboard layout on **page 31** to verify the amount of "X" space available.

Step 3

Create a 5P breaker unit catalog number, by following the instructions on **page 32**, or order the catalog number for parts on **page 33** and **page 34**.

Step 4

Determine if extra filler covers are required. Additional filler covers may be necessary to fill the unused space. Refer to **page 34** for filler plate information.

PRL5P parts section

Description	Page
Chassis layout	31
Breake assemblies catalot numbers	32
Branch devices	32–33
Main or through-feed lugs	33
Neutrals and grounds	34
Box, trim, and deadfront filler plates	34

PRL5P chassis layout

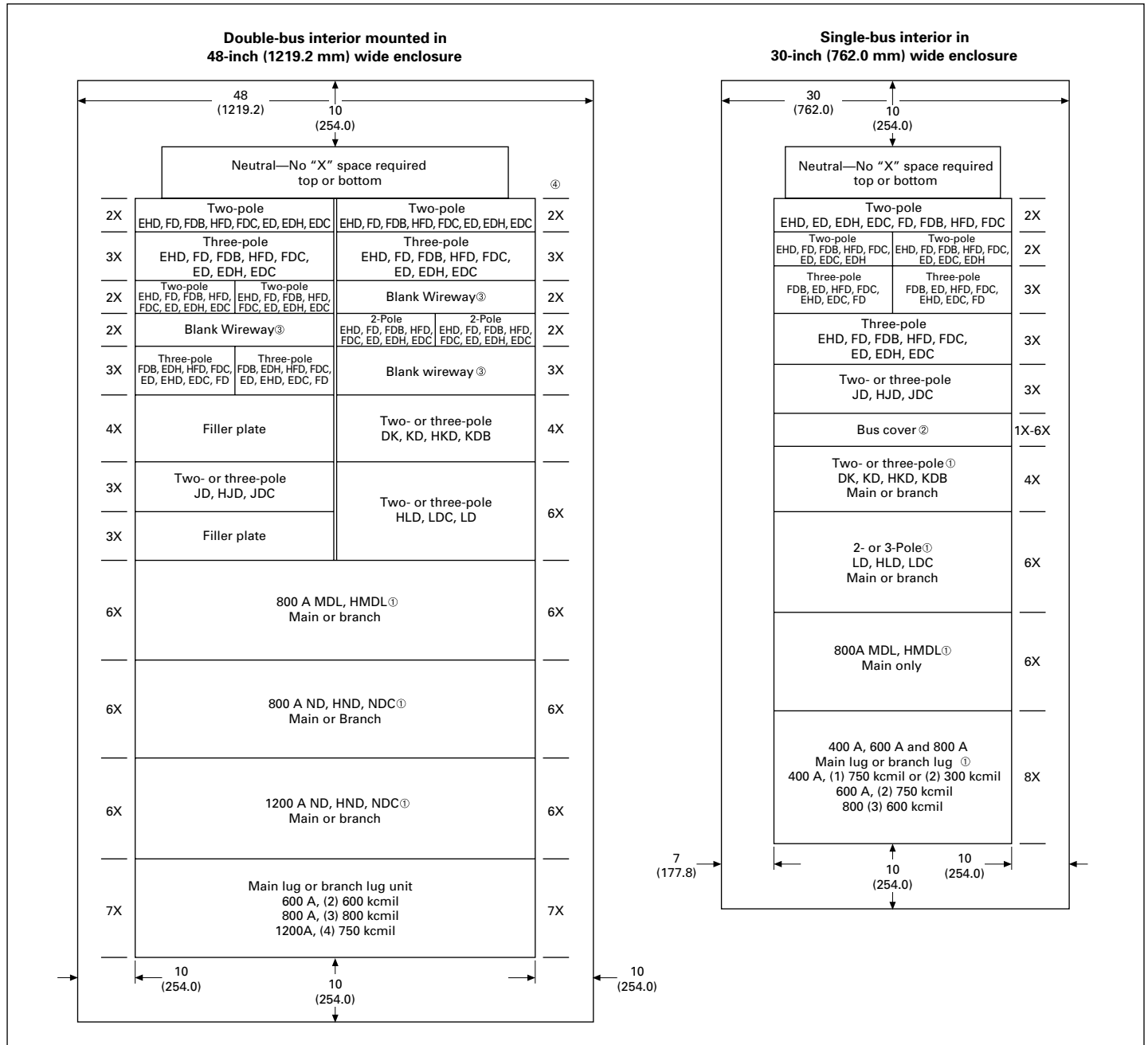
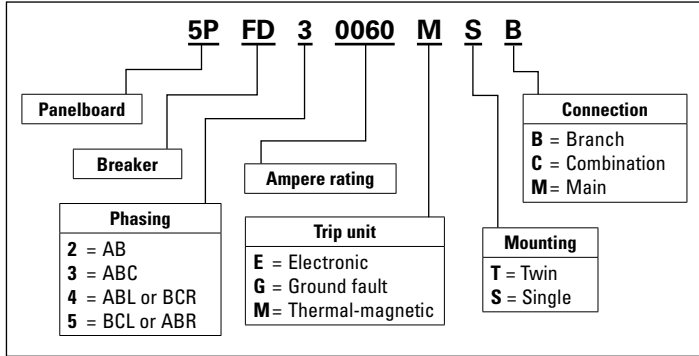

Figure 3. PRL5P chassis layout—dimensions in inches (mm)

① If used as a main device, must be mounted at the neutral end of panel.
 ② Fixed bus covers are required for unused spaces if NEC® six-circuit disconnect rule is to be met.
 ③ Blank wireway fillers are required opposite any dual breaker unit.
 ④ One “X” = 1.38 inches (35.1 mm).

PRL5P breaker assemblies catalog numbers

Table 47. Catalog numbering system—5P single or twin breakers with adapters



A plug-on unit is a complete assembly with a circuit breaker and mounting adapter to mount on a 5P panelboard.

Single indicates units that may be mounted in a single or double bus panel, and twin indicates double bus panels only. See **Table 50** and **Table 51**.

Table 48. Catalog numbering system—5P dual breakers with adapters

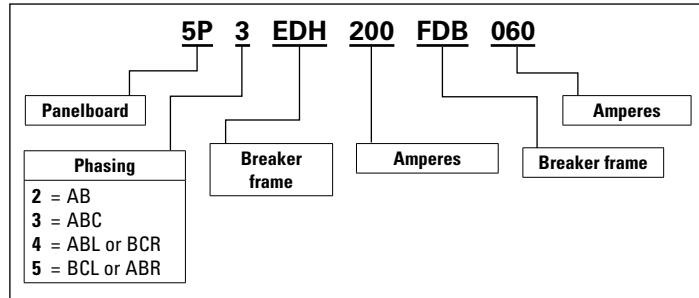

Any two F-Frame breakers listed may be mounted on the same 2X or 3X dual breaker adapter.

Dual breaker adapters may be used in single or double bus panels. Dual breaker adapters can **NOT** be mounted across from another adapter in a double bus panel. See **Table 52**.

Branch devices

Single-pole breakers in single adapter units. Include two or three single-pole 15–60 A assembled on one unit. (One X = 1.38 inches [35.1 mm])

Table 49. Single-pole breakers in single adapter units

Breaker type	Ampere rating	Interrupting rating (kA sym.)				"X" space required
		120 Vac	240 Vac	277 Vac	125 Vdc	
EHD	15–60	—	—	14	10	2X
FD	15–60	—	—	25	10	2X
HFD	15–60	—	—	65	10	2X
EHD	15–60	—	—	14	10	3X
FD	15–60	—	—	25	10	3X
HFD	15–60	—	—	65	10	3X

Table 50. Two- and three-pole breakers in single adapter units

Breaker type	Ampere rating	Interrupting rating (kA sym.)				"X" space required
		240 Vac	480 Vac	600 Vac	250 Vdc	
ED	100–225	65	—	—	—	3X
EDH	100–225	100	—	—	—	3X
EDC	100–225	200	—	—	—	3X
EHD	15–60	18	14	—	10	3X
EHD	70–100	18	14	—	10	3X
FD	15–60	65	25	18	10	3X
FD	70–100	65	25	18	10	3X
FD	110–225	65	25	18	10	3X
HFD	15–60	100	65	25	22	3X
HFD	70–100	100	65	25	22	3X
HFD	110–225	100	65	25	22	3X
FDC	15–60	200	100	35	22	3X
FDC	70–100	200	100	35	22	3X
FDC	110–225	200	100	35	22	3X
JD, JDB	70–225	65	35	18	10	3X
JD, JDB	70–225	65	35	18	10	3X
HJD	250	100	65	25	22	3X
HJD	70–225	100	65	25	22	3X
JDC	250	200	100	35	22	3X
JDC	70–225	200	100	35	22	3X
DK	100–400	65	—	—	—	4X
KD, KDB	250–400	65	35	25	10	4X
HKD	250–400	100	65	35	22	4X
KDC	250–400	200	100	50	22	4X
LD, LDB	300–600	65	35	25	22	6X
HLD ①②	300–600	100	65	35	25	6X
LDC	300–600	200	100	50	25	6X
MDL ①②	400–800	65	50	25	22	6X
HMDL ①②	400–800	100	65	35	25	6X
ND	400–1200	65	50	25	—	6X
HND ①②	400–1200	100	65	35	—	6X
NDC	400–1200	200	100	50	—	6X

① For use only in double bus chassis panelboards.

② 100% rated breakers are NOT available in 5P panelboards.

Dual breaker adapters—Any two breakers listed in **Table 52** may be mounted on the same 2X or 3X dual breaker adapter.

Dual breaker adapters may be used in single or double bus chassis. Dual breaker adapters can **NOT** be mounted across from another in a double bus chassis. (One X = 1.38 inches [35.1 mm]).

Table 51. Dual breaker adapters

Breaker type	Ampere rating	Interrupting rating (kA sym.)				"X" space required
		240 Vac	480 Vac	600 Vac	250 Vdc	
ED	100–225	65	—	—	—	3X
EDH	100–225	100	—	—	—	3X
EDC	100–225	200	—	—	—	3X
EHD	15–60	18	14	—	10	3X
EHD	70–100	18	14	—	10	3X
FD	15–60	65	25	18	10	3X
FD	70–100	65	25	18	10	3X
FD	110–225	65	25	18	10	3X
HFD	15–60	100	65	25	22	3X
HFD	70–100	100	65	25	22	3X
HFD	110–225	100	65	25	22	3X
FDC	15–60	200	100	35	22	3X
FDC	70–100	200	100	35	22	3X
FDC	110–225	200	100	35	22	3X



5PFD30060MSB

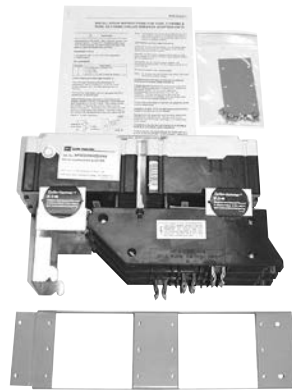

5P3EDH200FDB060

PRL5P main or through-feed lugs

Table 52. PRL5P main or through-feed lugs

Description	Ampere rating	Wire size range	"X" space required	Catalog number
Single bus chassis mounting				
Ampere lug unit	400	(1) 1/0–500 or (2) 1/0–250 kcmil	8X	5PLUG3400SC
Ampere lug unit	600	(2) 1/0–500 kcmil	8X	5PLUG3600SC
Ampere lug unit	800	(2) #2–500 or (3) #2–400 kcmil	8X	5PLUG3800SC
Double bus chassis mounting				
1200 A lug unit	600–1200	(4) #4–750 kcmil	7X	5PLUG31200TC



5PLUG3800SC



5PLUG31200TC

PRL5P neutrals and grounds

Neutral assembly

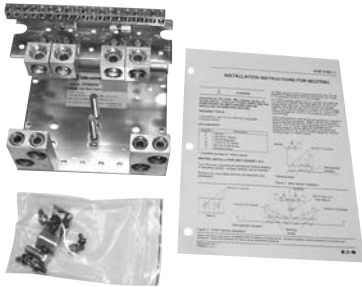

5PN800A

Table 53. Neutral assemblies with lugs

Incoming number of cables and wire size	Catalog number
(4) 250–500 kcmil 800 A aluminum/copper	5PN800A
(4) 250–500 kcmil 800 A copper	5PN800C
(4) 250–500 kcmil 1200 A aluminum/copper	5PN1200A
(4) 250–500 kcmil 1200 A copper	5PN1200C

Table 54. Additional lugs for neutral assemblies

Description	Catalog number
(1) 1/0–750 kcmil or (2) 1/0–300 kcmil aluminum/copper	5PNL400
(2) 250–500 kcmil aluminum/copper	5PNL600
(3) 3/0–750 kcmil aluminum/copper	5PNL800
(4) 3/0–750 kcmil aluminum/copper	5PNL1200
Ground bar type	
1200 A aluminum/copper	5PG1200A
1200 A copper	5PG1200C

Ground bar assemblies



5PG1200A

Table 55. Grounded “B” phase adapter kits

Ampere rating	Main device	Catalog number
Single bus chassis		
400	Main lugs	5PCGBLUG400S
600	Main lugs	5PCGBLUG600S
600	LD breaker	5PCGBLD600S
800	Main lugs	5PCGBLUG800S
Double bus chassis		
800	MD breaker	5PCGBMD800T
1200	Main lugs	5PCGBLUG1200T
1200	ND breaker	5PCGBND1200T

PRL5P box, trim, and deadfront filler plates

Table 56. PRL5P box, trim, and deadfront filler plates

Chassis “X” factor	Catalog number		
	Back box	Trim	Trim door kit
Single bus chassis—30.00-Inch (762.0 mm) wide box			
24X	5PB2430G	5PT2430S	5PD24S
32X	5PB3230G	5PT3230S	5PD32S
40X	5PB4030G	5PT4030S	5PD40S
Double bus chassis—48.00-Inch (1219.2 mm) wide box			
24X	5PB2448G	5PT2448S	5PD24T
32X	5PB3248G	5PT3248S	5PD32T
40X	5PB4048G	5PT4048S	5PD40T

Table 57. Deadfront filler plates

Vertical “X” increment	Catalog number	
	Single bus chassis ①	Double bus chassis
1X	5PFP1S	5PFP1T
2X	5PFP2S	5PFP2T
3X	5PFP3S	5PFP3T
4X	5PFP4S	5PFP4T
5X	5PFP5S	5PFP5T
6X	5PFP6S	5PFP6T

① These fillers are also used across from a breaker unit in a double bus chassis.



5PT2430S



5PD24S



5PFP3S



5PFP3T

PRL1a, 2a-LX

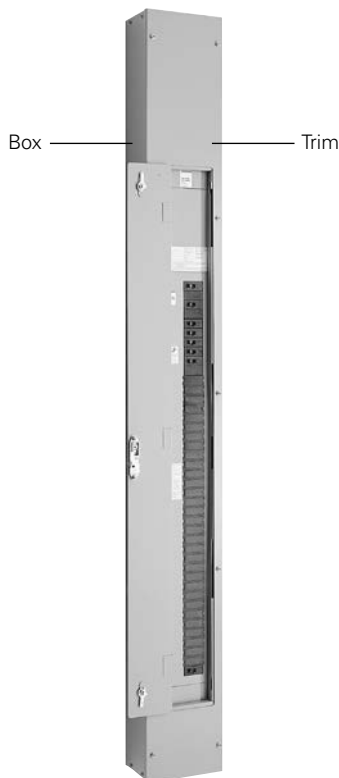

Pow-R-Command

For replacement parts, see PRL3a section, **page 19**.
The following parts are available:

- Connector kits
- Ground assemblies
- Service entrance kits
- Deadfront covers
- Trim locks



Pow-R-Command

Table 58. Type 1 box and trims

Box height in inches (mm)	Catalog number		
	Box	Surface trim standard	Surface trim door-in-door
Incoming location top fed			
69.00 (1752.6)	YSC969	LTC969S	LTCD969S
78.00 (1981.2)	YSC978	LTC978S	LTCD978S
81.00 (2057.4)	YSC981	LTC981S	LTCD981S
90.00 (2286.0)	YSC990	LTC990S	LTCD990S
Incoming location bottom fed			
69.00 (1752.6)	YSC969	LTC969SB	LTCD969SB
78.00 (1981.2)	YSC978	LTC978SB	LTCD978SB
81.00 (2057.4)	YSC981	LTC981SB	LTCD981SB
90.00 (2286.0)	YSC990	LTC990SB	LTCD990SB

Additional services

Because virtually all panelboards are supplied to meet specific customer requirements, other parts not listed in this publication might occasionally be needed. Price and availability for parts not shown here may be obtained by contacting your local satellite plant and providing a complete description of the part along with the data on the panelboard nameplate.

Should you experience difficulty in determining what replacement parts are needed, contact your local satellite plant manager who can provide help to:

- Identify and recommend replacement parts
- Remove damaged parts and instruct you in how to install replacement parts
- Verify the correct connector kits that should be ordered for each circuit breaker or fusible switch
- Retrofit existing panelboard boxes with new Pow-R-Line interiors
- Provide a recommended spare parts list

Eaton
1000 Eaton Boulevard
Cleveland, OH 44122
United States
Eaton.com

© 2017 Eaton
All Rights Reserved
Printed in USA
Publication No. RP01400001E / Z19610
October 2017



Eaton is a registered trademark.
All other trademarks are property
of their respective owners.