

Low Profile, Single & Dual Channel Steel Raceway

2400® Series Raceway is a single compartment raceway designed for communication or power applications and ideal for use in classrooms, offices, and hotel applications, or anywhere a small low profile raceway is needed.

2400D® Series Divided Raceway is a low profile steel raceway for use where a limited number of power and low voltage cables are required in the same raceway.

2400 Series Raceway shown with our new Downward Facing Receptacles in a typical school library application.



FEATURES & BENEFITS

- **Steel raceway.** Provides superior strength for any dry location.
- **Single- and dual-compartment attractive low profile raceway design.** Provides functionality and flexibility with aesthetics for single or dual service applications.
- **Downward facing activations.** Streamlines the raceway appearance and provides increased protection for both activations and cabling.
- **ScuffCoat™ finish.** Tough durable ScuffCoat finish makes a scratch-resistant surface that can be painted.
- **Complete line of fittings.** Provides complete wiring solution and allows for interconnection between raceway systems.
- **Removable cover.** Allows easy access to wiring for changes and additions.
- **One- and two-gang device boxes.** Now you can wire devices into the raceway system, making 2400 Series Raceway an excellent choice for communication wiring.
- **Over the raceway boxes.** Provides tremendous labor savings. Boxes mount over continuous run of raceway base eliminating the need to cut raceway when locating devices.
- **Bend radius control fittings.** Corner and tee fittings are UL verified to maintain full capacity 2" (51mm) bend radius control and exceed the recommendations of EIA/TIA 569A. These fittings provide cable protection in both lay-in and pull-through cable installations.
- **V2475D Bridge Fitting.** Provides ability to bridge 2400 Series Raceways over existing installations of 2400, 700, and 500 Series Raceways.
- **In-line field-configurable receptacles.** Receptacles can be installed at any point along the raceway without a box.
- **In-line 106 frame data outlet.** A wide variety of data modules can be installed anywhere along the raceway run without a box.
- **Communication connectivity options.** Accepts industry standard and proprietary devices from a wide range of manufacturers to provide a seamless and aesthetically pleasing interface for voice, data, audio, and video applications at the point of use.
- **UL and cUL Listed component raceways.** File E4376 Guide RJBT, Fittings: File E41751 Guide RJPR. Meets Article 386 of NEC and meets Section 12-600 of CEC.



Download this product's PEP ecopassport® environmental product declaration at www.legrand.us/resources-and-downloads. This declaration conforms with ISO 14025 and 14040 and is in alignment with EN 15804.



24DWNR Downward Facing Activation shown in a security application.



2400 Series Raceway shown with our new 2444D-2N Divided Device Box in a typical classroom application.

2400 Series Raceway System Layout (Power Applications)

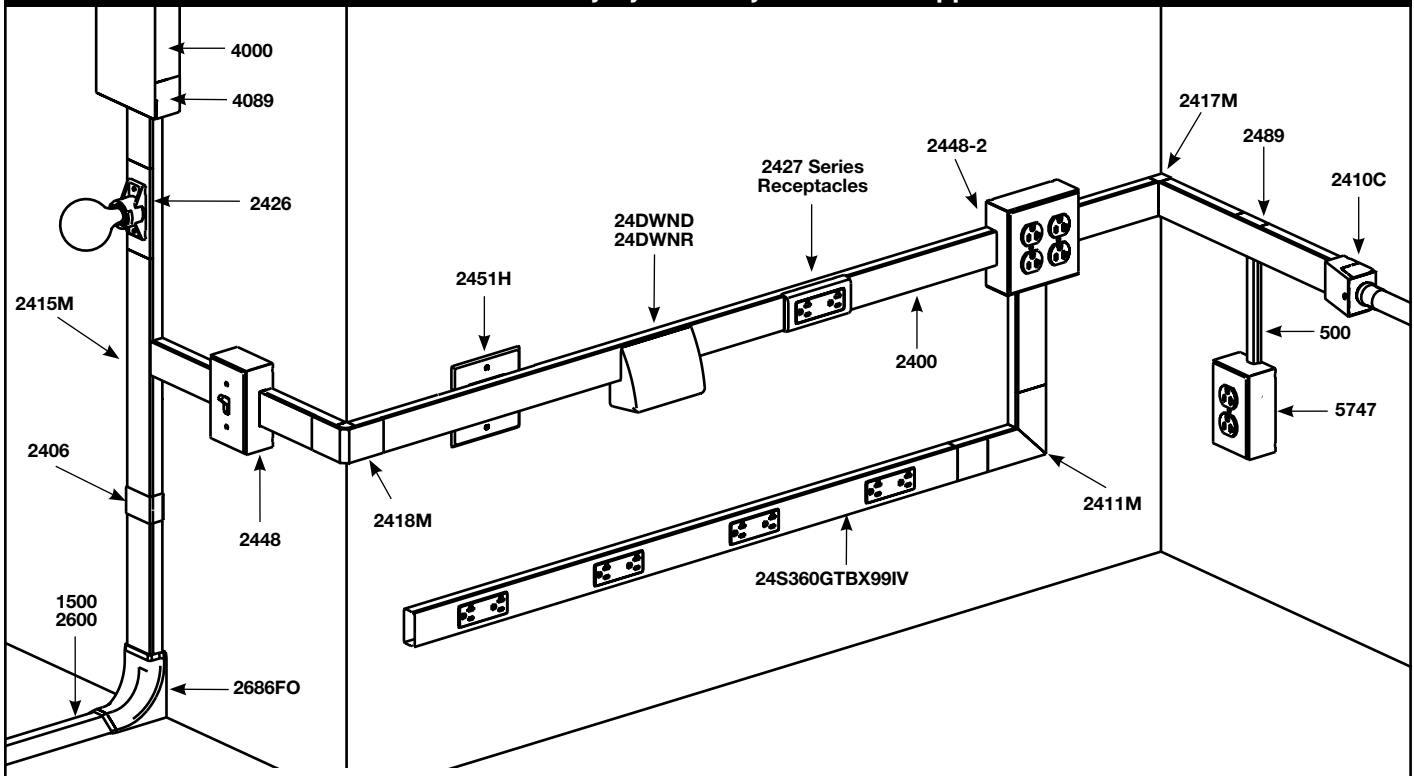

NOTE: Illustration is for product applications and may not represent proper circuit wiring.
Color prefix is not included in part number identification.

2400 Series Raceway System Layout (Communication Applications)

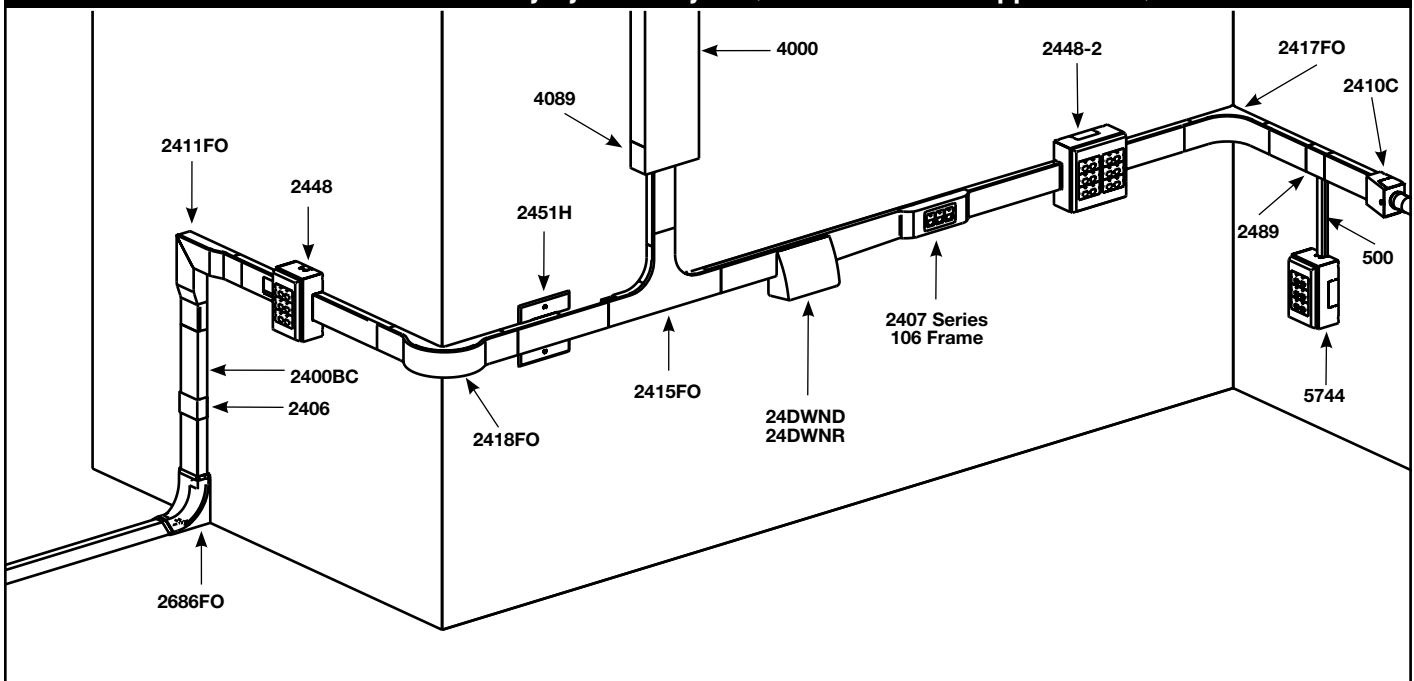

NOTE: Illustration is for product applications and may not represent proper circuit wiring.
Color prefix is not included in part number identification.

2400 Series Raceway Wire Fill Capacity Charts

2400 Raceway Wire Fill Capacities for Power*

WIRE SIZE THHN/THWN	O.D. Inches (mm)		NUMBER OF CONDUCTORS (40% FILL)	
			WITHOUT DEVICES	WITH 2427 RECEPTACLE
14 AWG	0.111	(2.8)	57	12
12 AWG	0.130	(3.3)	41	9
10 AWG	0.164	(4.2)	26	-

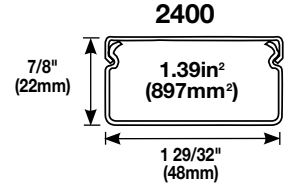



*For additional information, refer to Technical Section in the current version of the Wiremold Catalog.

2400 Raceway Wire Fill Capacities for Communications

CABLE/WIRE SIZE	O.D. (Approx Dia.)		40% FILL**
	Inches	(mm)	
UNSHIELDED TWISTED PAIR	4-Pair, 24 AWG, Cat 3	0.190 (4.8)	19
	4-Pair, 24 AWG, Cat 5e	0.210 (5.3)	16
	4-Pair, 24 AWG, Cat 6	0.250 (6.3)	11
	4-Pair, 24 AWG, Cat 6a	0.354 (8.9)	5
	25-Pair, 24 AWG	0.410 (10.4)	4
COAXIAL	RG6/U	0.270 (6.9)	9
FIBER	ZipCord	0.118 x 0.236 (3 x 6)	20
	Round 4-Strand Fiber	0.187 (4.8)	20
	Round 6-Strand Fiber	0.256 (6.5)	10

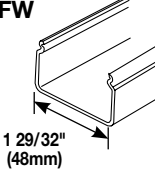
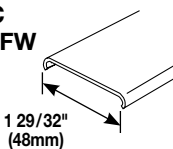
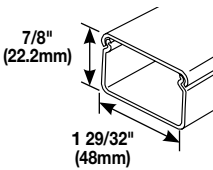
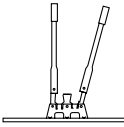
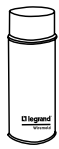
2400 Series Raceway Base & Cover Ordering Information

Catalog No./Item	Description/Specifications	Catalog No./Item	Description/Specifications
V2400B V2400B-10 2400B-FW 2400B-10FW	Raceway Base – .040" (1.0mm) steel; packed twenty 5' (1.5m) lengths per carton, or ten 10' (3.0m) lengths per carton.	V2400C 2400C-FW	Raceway Cover – .040" (1.0mm) steel; packed twenty 5' (1.5m) lengths per carton.
			
V2400BC 2400BC-FW	Raceway Base & Cover – .040" (1.0mm) steel. Packed ten 5' (1.5m) lengths of base and cover per carton.	624	2400 Raceway Base & Cover Cutter – Portable cutter for 2400 & 2400D Series Raceway Base and Cover. Provides a clean and easy square cut every time.
			
NOTE: "V" prefix indicates Ivory color, "-FW" suffix indicates Fog White color.		624BCK	Replacement Blade Kit – Replacement blades and die set for 624 Cutter.
		IWE-S DVWE-S	Spray Paint – Used for touching up large areas. Available in Ivory (IWE-S) or Fog White (DVWE-S). Contains 12 oz. of paint.
			NOTE: Can only be shipped via ground transportation.
		IWE-P DVWE-P	Touch-Up Paint Pen – Used for touching up small areas. Available in Ivory (IWE-P) or Fog White (DVWE-P). Contains 0.3 oz. of paint.
			

2400 Series Raceway Fittings Ordering Information

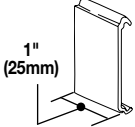
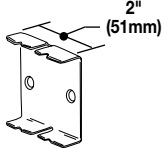
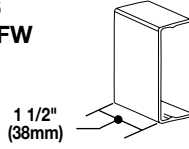
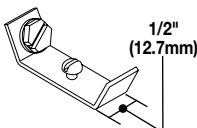
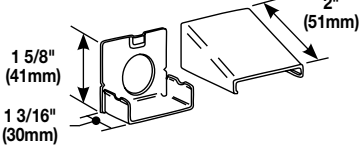
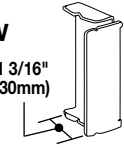
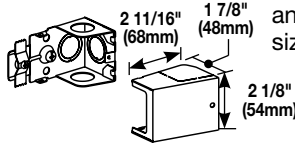
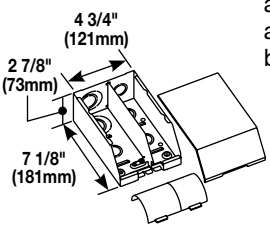
Catalog No./Item	Description/Specifications
2400WC 	Wire Clip – Additional support for conductors in 2400 Series Raceway. (Nonmetallic)
2401 	Coupling – Joins sections of 2400B Base.
V2406 2406-FW 	Cover Clip – Covers joints where sections of 2400 Series Raceway cover or base come together. Nonmetallic construction.
2409 	Ground Clamp – Connects equipment grounding conductor to 2400 Series Raceway. No. 10 ground screw provided.
V2410A 2410A-FW 	Entrance End Fitting – Connects 2400 Series Raceway with 1/2" trade size conduit or armored cable.
V2410B 2410B-FW 	Blank End Fitting – Closes off open end of 2400 Series Raceway.
V2410C 2410-FW 	Entrance End Fitting – Feeds 2400 Series Raceway. Includes 1/2" and 3/4" trade size KOs on end and bottom. Additional 1/2" trade size KO on both sides.
V2410DFO 2410DFO-FW 	Divided Entrance End Fitting – Feeds 2400 & 2400D Series Raceway. Includes 1/2", 3/4", and 1" trade size KOs on back and end. Removable divider and bend radius control insert included.

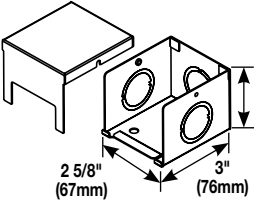
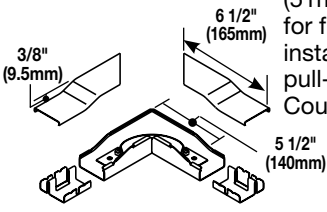
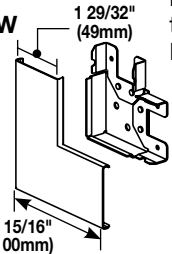
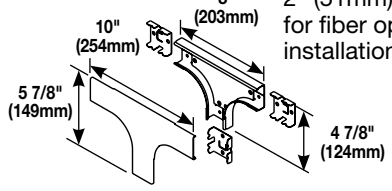
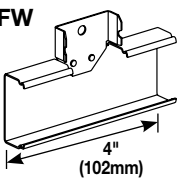
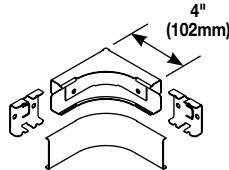
Catalog No./Item	Description/Specifications
V2410FC 2410FC-FW 	Full Capacity Entrance End Fitting – Feeds 2400 Series Raceway. Includes three 3/4" and 1" concentric trade size KOs.
V2411FO 2411FO-FW 	Radiused Flat Elbow – 90° flat corner that provides 2" (51mm) cable bend radius control for fiber optic and UTP/STP cable installations. Ideal for lay-in or pull-through installations. Couplings included.
V2411M 2411M-FW 	Flat Elbow – Makes right angle turns in runs of 2400 Series Raceway on same surface.
V2415FO 2415FO-FW 	Radiused Tee – Branches at right angles. Provides a controlled 2" (51mm) cable bend radius control for fiber optic and UTP/STP cable installations. Couplings included.
V2415M 2415M-FW 	Tee – Branches at right angles. Couplings included.
V2417FO 2417FO-FW 	Radiused Internal Elbow – 90° internal corner. Provides a controlled 2" (51mm) cable bend radius control for fiber optic and UTP/STP cable installations. Couplings included.

NOTE: "V" prefix indicates Ivory color, "-FW" suffix indicates Fog White color.

2400 Series Raceway Fittings Ordering Information (continued)

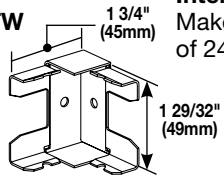
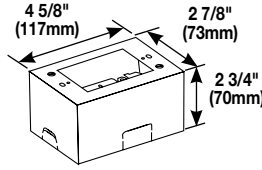
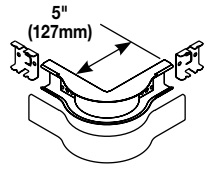
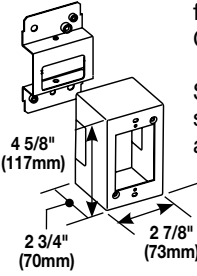
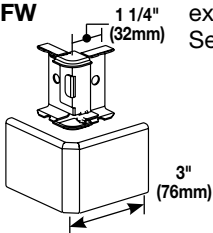
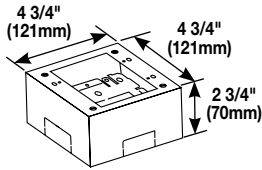
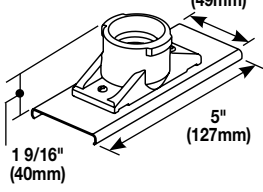
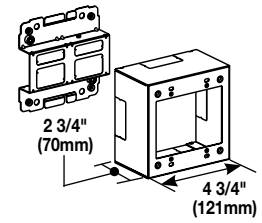
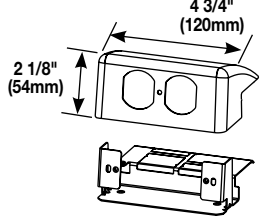
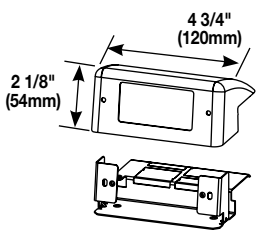
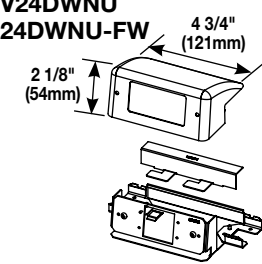
Catalog No./Item	Description/Specifications	Catalog No./Item	Description/Specifications
V2417M 2417M-FW 	Internal Elbow – Makes 90° internal corners in runs of 2400 Series Raceway.	V2444 2444-FW 	Extra Deep Device Box – One-gang device box has extra depth to permit installation of cabling that requires greater bend radius and storage. Cover has one twistout for 2400 Series Raceway on two sides and one twistout for 500 and 700 Series Raceway on the top and bottom. Accepts industry standard faceplates for electrical and communication devices.
V2418FO 2418FO-FW 	Radiused External Elbow – 90° external elbow. Provides a controlled 2" (51mm) cable bend radius control for fiber optic and UTP/STP cable installations. Couplings included.	V2444D 2444D-FW 	Device Box – One-gang, labor saving, over-the-raceway box for use with 2400 Series Raceway. Cover has two twistouts for 2400 Series Raceway. Accepts industry standard faceplates for electrical and communication devices.
V2418M 2418M-FW 	External Elbow – Makes 90° external corners in runs of 2400 Series Raceway.	V2444-2 2444-2FW 	Extra Deep Device Box – Two-gang device box has extra depth to permit installation of cabling that requires greater bend radius and storage. Cover has four twistouts for 2400 Series Raceway. Base includes knockout to enable extension from existing single-gang flush wall box and 1/2" and 1" concentric trade size KOs. Accepts industry standard faceplates for electrical and communication devices.
V2426 2426-FW 	Lamp Holder – Medium base lamp holder 660W, 250V. Black general purpose phenolic.	V2444-2LS 2444-2LSFW 	Device Box – Two-gang, labor saving, over-the-raceway box for use with 2400 Series Raceway. Cover has four twistouts for 2400 Series Raceway. Accepts industry standard faceplates for electrical and communication devices.
V24DWND 24DWND-FW 	Downward Duplex Device Bracket – Labor saving, over-the-raceway device bracket. For 15A or 20A duplex receptacles or 106 style data frame in 2400 Series Raceway.	V24DWNU 24DWNU-FW 	Downward Extron® MAAP Device Plate – Accepts two Extron® Electronics MAAP single space modules.
V24DWRN 24DWRN-FW 	Downward Decorator Device Bracket – Labor saving over-the-raceway device bracket. For 15A or 20A decorator/GFCI receptacles or decorator style data frame in 2400 Series Raceway.		

NOTE: "V" prefix indicates Ivory color, "-FW" suffix indicates Fog White color.

2400 Series Raceway Fittings Ordering Information (continued)

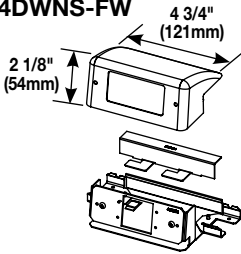
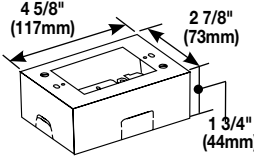
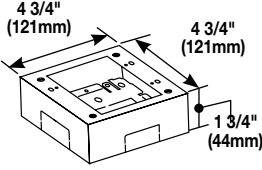
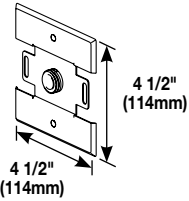
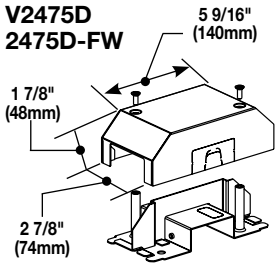
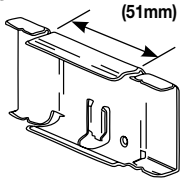
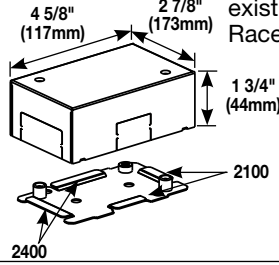
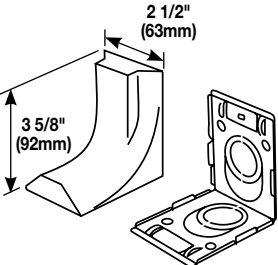
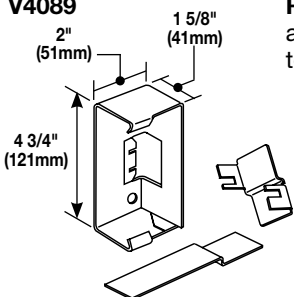
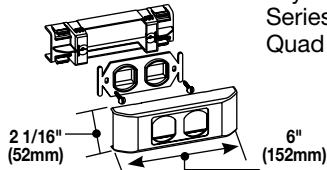
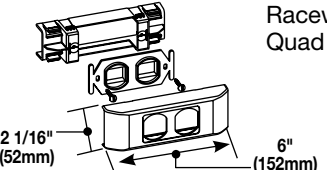
Catalog No./Item	Description/Specifications
V24DWNS 24DWNS-FW 	Downward Ortronics® Series II Device Plate – Accepts one Ortronics® Series II module.
V2448 2448-FW 	Device Box – One-gang device box. Cover has one twistout for 2400 Series Raceway on two sides and one twistout for 500 and 700 Series Raceway on the top and bottom. Base includes knockout to enable extension from existing single-gang flush wall box and 1/2" trade size KOs. Accepts industry standard faceplates for electrical and communication devices.
V2448-2 2448-2FW 	Device Box – Two-gang device box. Cover has four (4) twistout for 2400 Series Raceway. Base includes knockout to enable extension from existing single-gang flush wall box and 1/2" trade size KOs. Accepts industry standard faceplates for electrical and communication devices.
V2451H 2451H-FW 	Back Feed Fitting – Feeds 2400 Series Raceway from an existing outlet box. Equipped with 1/2" trade size male bushing and lock nut washer for grounding.
V2475D 2475D-FW 	Bridge Fitting – Allows 2400 Series Raceway to bridge over existing installations of 2400, 500, or 700 Series Raceways.
V2489 	Side Reducing Connector – Connects 2400 Series Raceway with 500 Series Raceway.
V2489TB 	Transition Box – Connects existing installations of 2100 Series Raceway to 2400 Series Raceway.
2686FO 	Transition Feed Fitting – Eliminates offsetting of 2400 Series Raceway in connecting with surface panel boxes. Has 3/4" and 1" concentric trade size KOs with 1" trade size KO elongated so adjustment from surface to center of bushing is 1" (25mm) minimum to 1 5/8" (41mm) maximum. Has twistouts for transition to 1500 and 2600 Series Pancake Raceways.
V4089 	Reducing Connector – Reduces and connects 4000 Series Raceway to 2400 Series Raceway.
V2407-2CM 2407-2CMFW 	106 Device Bracket and Frame – Installs two network wiring keystone device modules in 2400 Series Raceway. Does not support Quad 106 Frame.
V2407-2TJ 2407-2TJFW 	106 Device Bracket and Frame – Installs two Ortronics TracJack device modules in 2400 Series Raceway. Does not support Quad 106 Frame.

NOTE: "V" prefix indicates Ivory color, "-FW" suffix indicates Fog White color.

2400 Series Raceway Receptacles Ordering Information

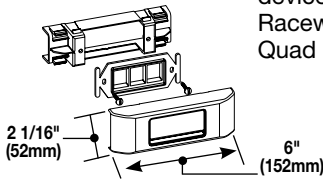
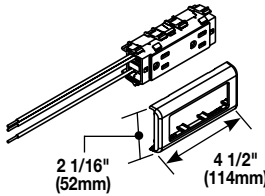
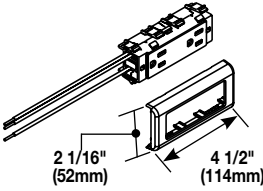
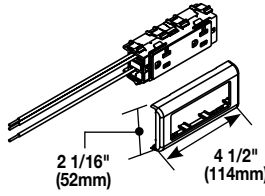
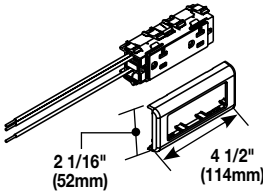
Catalog No./Item	Description/Specifications	Catalog No./Item	Description/Specifications
V2407-3TJ 2407-3TJFW	106 Device Bracket and Frame – Installs three Ortronics TracJack device modules in 2400 Series Raceway. Does not support Quad 106 Frame.	IG2427GA	15A Isolated Ground Duplex Receptacle – 3-Wire 125V NEMA 5-15R orange receptacle provided with 10-1/2" (267mm) pigtails and inline splice connectors.
			
V2427GA	15A Duplex Receptacle – 3-Wire 125V NEMA 5-15R receptacle provided with 10-1/2" (267mm) pigtails and inline splice connectors.	IG2427GT	20A Isolated Ground Duplex Receptacle – 3-Wire 125V NEMA 5-20R orange receptacle provided with 10-1/2" (267mm) pigtails and inline splice connectors.
			
V2427GT	20A Duplex Receptacle – 3-Wire 125V NEMA 5-20R receptacle provided with 10-1/2" (267mm) pigtails and inline splice connectors.	NOTE: "V" prefix indicates Ivory color, "-FW" suffix indicates Fog White color.	
			

2400D Series Divided Raceway System Layout for Power & Data

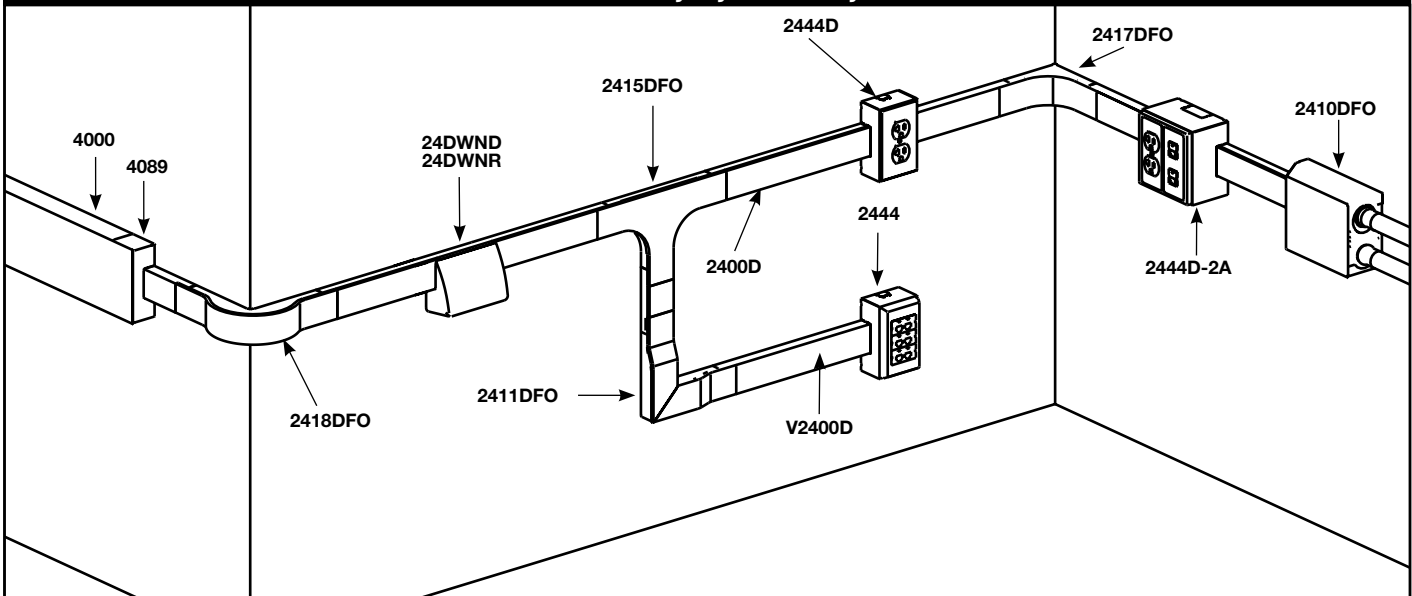

NOTE: Illustration is for product applications and may not represent proper circuit wiring.
Color prefix is not included in part number identification.

2400D Series Divided Raceway Wire Fill Capacities

2400D Series Divided Raceway Wire Fill Capacities for Power

WIRE SIZE THHN/THWN	O.D.		NUMBER OF CONDUCTORS (40% FILL)	
	Inches	(mm)	1/3 COMP.	2/3 COMP.
14 AWG	0.111	(2.8)	11	26
12 AWG	0.130	(3.3)	9	19
10 AWG	0.164	(4.2)	6	11

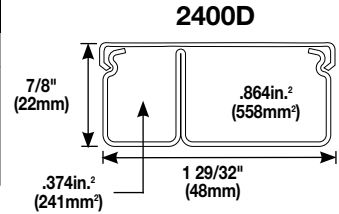



*For additional information refer to Technical Section of Wiremold Product Guide.

2400D Series Divided Raceway Wire Fill Capacities for Communications

CABLE/WIRE SIZE		O.D. (Approx Dia.)		1/3 COMPARTMENT	2/3 COMPARTMENT
		Inches	(mm)	40% FILL	40% FILL**
UNSHIELDED TWISTED PAIR	4-Pair, 24 AWG, Cat 3	0.190	(4.8)	5	12
	4-Pair, 24 AWG, Cat 5e	0.210	(5.3)	4	9
	4-Pair, 24 AWG, Cat 6	0.250	(6.3)	3	7
	4-Pair, 24 AWG, Cat 6a	0.354	(8.9)	1	3
	25-Pair, 24 AWG	0.410	(10.4)	1	2
COAXIAL	RG6/U	0.270	(6.9)	2	6
FIBER	ZipCord	0.118 x 0.236	(3 x 6)	5	12
	Round 4-Strand Fiber	0.187	(4.8)	5	12
	Round 6-Strand Fiber	0.256	(6.5)	2	6

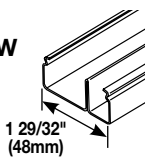
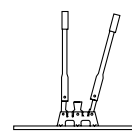
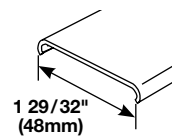
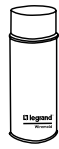
2400D Series Divided Raceway Base & Cover Ordering Information

Catalog No./Item	Description/Specifications	Catalog No./Item	Description/Specifications
V2400BD 2400BD-FW	 Divided Raceway Base – .040" (1.0mm) steel; divided into 1/3 and 2/3 compartments. Packed ten 10' (3.0m) lengths per carton.	624	 2400 Raceway Base & Cover Cutter – Portable cutter for 2400 & 2400D Series Raceway Base and Cover. Provides a clean and easy square cut every time.
V2400C 2400C-FW	 Raceway Cover – .040" (1.0mm) steel; packed twenty 5' (1.5m) lengths per carton.	624BCK	Replacement Blade Kit – Replacement blades and die set for 624 Cutter.
		IWE-S DVWE-S	 Spray Paint – Used for touching up large areas. Available in Ivory (IWE-S) or Fog White (DVWE-S). Contains 12 oz. of paint. NOTE: Can only be shipped via ground transportation.
		IWE-P DVWE-P	 Touch-Up Paint Pen – Used for touching up small areas. Available in Ivory (IWE-P) or Fog White (DVWE-P). Contains 0.3 oz. of paint.

NOTE: "V" prefix indicates Ivory color, "-FW" suffix indicates Fog White color.

2400D Series Divided Raceway Fittings (continued)

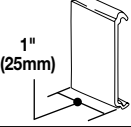
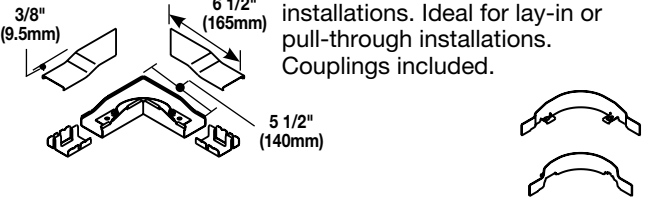
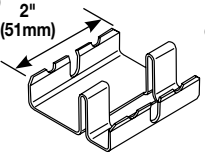
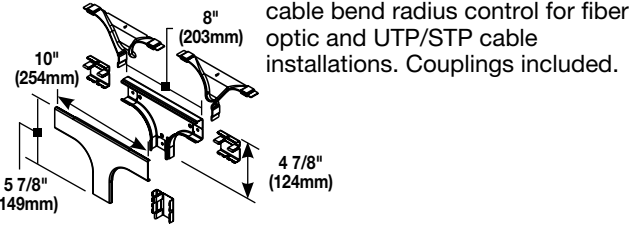
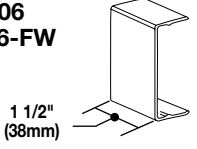
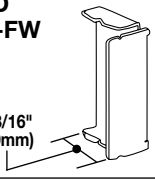
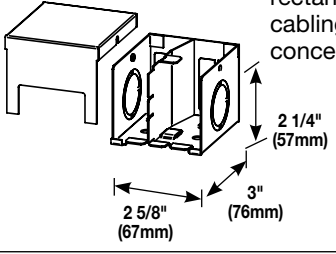
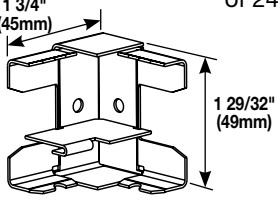
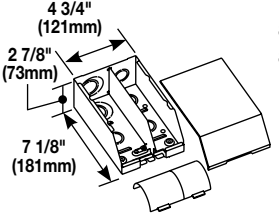
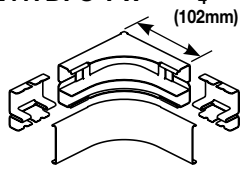
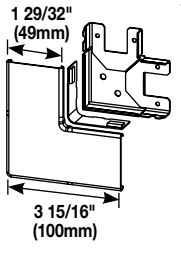
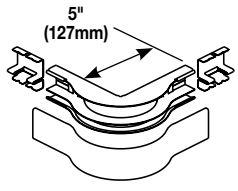
Catalog No./Item	Description/Specifications	Catalog No./Item	Description/Specifications
2400WC 	Wire Clip – Additional support for conductors in 2400D Series Raceway. (Nonmetallic)	V2411DFO 2411DFO-FW 	Radiused Divided Flat Elbow – 90° flat elbow with integral dividers to provide 2" (51mm) full capacity cable bend radius control for fiber optic and UTP/STP cable installations. Ideal for lay-in or pull-through installations. Couplings included.
2401D 	Divided Coupling – Joins sections of 2400DB Divided Base.	V2415DFO 2415DFO-FW 	Radiused Divided Tee – For branches at right angles. Provides 2" (51mm) full capacity cable bend radius control for fiber optic and UTP/STP cable installations. Couplings included.
V2406 2406-FW 	Cover Clip – Covers joints where sections of 2400 Series Raceway cover or base come together. Nonmetallic construction.	V2417D 2417D-FW 	Divided Internal Elbow – Makes internal 90° corners in runs of 2400D Series Raceway.
V2410BD 2410BD-FW 	Divided Blank End Fitting – Closes off open end of 2400D Series Raceway.	V2417DFO 2417DFO-FW 	Radiused Divided Internal Elbow – 90° internal corner. Provides a 2" (51mm) full capacity cable bend radius control for fiber optic and UTP/STP cable installations. Couplings included.
V2410D 2410D-FW 	Divided Entrance End Fitting – Feeds 2400D Series Raceway. Two 1/2" trade size KOs and two rectangular KOs for communication cabling. Two additional 1" and 3/4" concentric trade size KOs on sides.	V2418DFO 2418DFO-FW 	Radiused Divided External Elbow – 90° external elbow. Provides a 2" (51mm) full capacity cable bend radius control for fiber optic and UTP/STP cable installations. Couplings included.
V2410DFO 2410DFO-FW 	Divided Entrance End Fitting – Feeds 2400 & 2400D Series Raceway. Includes 1/2", 3/4", and 1" trade size KOs on back and end. Removable divider and bend radius control insert included.	V2411D 2411D-FW 	Divided Flat Elbow – Makes right angle turns in runs of 2400D Series Raceway on same surface.

NOTE: "V" prefix indicates Ivory color, "-FW" suffix indicates Fog White color.

2400 Series Divided Raceway Fittings Ordering Information (continued)

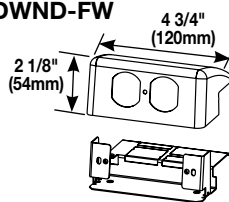
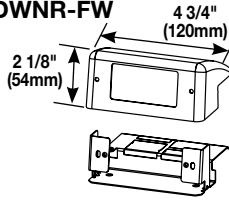
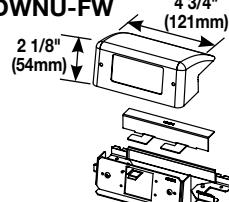
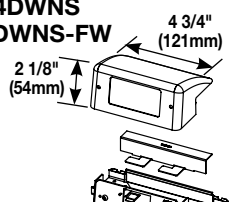
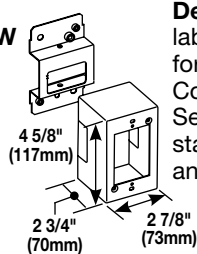
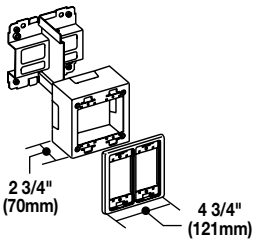
Catalog No./Item	Description/Specifications
V24DWND 24DWND-FW 	Downward Duplex Device Bracket – Labor saving over-the-raceway device bracket. For 15A or 20A duplex receptacles or 106 style data frame in 2400D Series Raceway.
V24DWNR 24DWNR-FW 	Downward Decorator Device Bracket – For 15A and 20A decorator/GFCI receptacles or 106 style data frame in 2400D Series Raceway.
V24DWNU 24DWNU-FW 	Downward Extron® MAAP Device Plate – Accepts two Extron® Electronics MAAP single space modules. Raceway base must be cut.
V24DWNS 24DWNS-FW 	Downward Ortronics® Series II Device Plate – Accepts one Ortronics® Series II module. Raceway base must be cut.
V2444D 2444D-FW 	Device Box – One-gang, labor saving, over-the-raceway box for use with 2400D Series Raceway. Cover has two twistouts for 2400D Series Raceway. Accepts industry standard faceplates for electrical and communication devices.
V2444D-2A 2444D-2AFW 	Divided Device Box – Divided two-gang, labor saving, over-the-raceway box for use with 2400D Series Raceway. Provides the ability to have both power and low voltage at a single point-of-use. Accepts 5507 Series Faceplates, Ortronics® TracJack & Series II Modules (requires S2-EPL Plate), Pass & Seymour Activate Series Inserts (requires CM-EPLA Plate) and Wiremold CM2 Series Open System Communication Modules (requires CM-EPLA Plate).

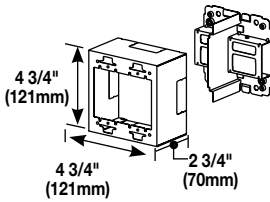
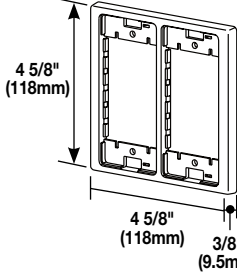
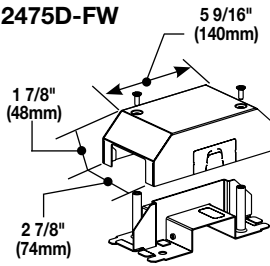
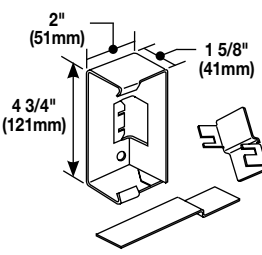
Catalog No./Item	Description/Specifications
V2444D-2N 2444D-2NFW 	Divided Box – Labor savings over-the-raceway box. A divided two-gang box for use with 2400D Series Raceway. Allows both power and low voltage at a single point-of-use. For use with commercially available faceplates (not supplied).
V2450 2450-FW 	Device Bracket – For use with 2444D-2N for both power and low voltage at a single point of use. Accepts 5507 Series Faceplates, Ortronics® TracJack & Series II Modules (requires S2-EPL Plate), Pass & Seymour Activate Series Inserts (requires CM-EPLA Plate) and Wiremold CM2 Series Open System Communication Modules (requires CM-EPLA Plate).
V2475D 2475D-FW 	Bridge Fitting – For allowing 2400D Series Raceway to bridge over existing installations of 2400, 2400D, 500, and 700 Series Raceways.
V4089 	Reducing Connector – For reducing from 4000 Series Raceway to 2400D Series Raceway.

NOTE: "V" prefix indicates Ivory color, "-FW" suffix indicates Fog White color.

5507 Series Faceplates Ordering Information

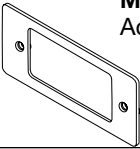
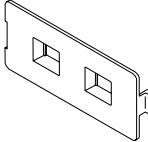
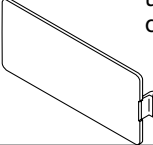
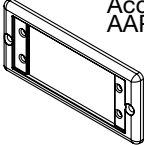
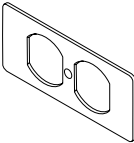
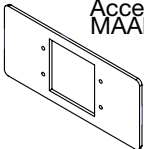
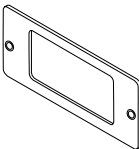
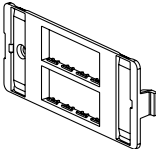
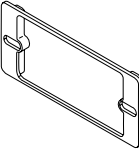
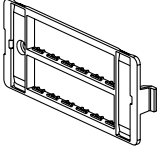
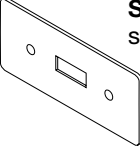
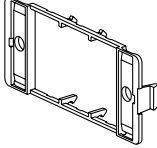
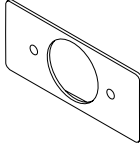
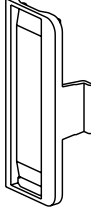
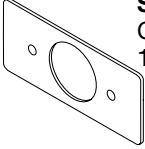
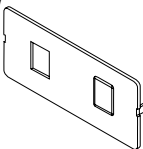
Catalog No./Item	Description/Specifications	Catalog No./Item	Description/Specifications
5507AD 5507AD-FW	Modular Furniture Adapter – Accepts modular furniture adapters. 	5507FRJ 5507FRJ-FW	Flush Dual RJ11/RJ45 Faceplate – Mounts one or two keystone device modules, recessed to provide a flush installation. Has one opening and a KO for the other. 
5507B 5507B-FW	Blank Faceplate – Covers unused compartments in the device bracket. 	5507AAP 5507AAP-FW	Extron® AAP Faceplate – Accepts two Extron® Electronics AAP single space modules. 
5507D 5507D-FW	Duplex Faceplate – Covers duplex style devices. Accepts 106 Frame. 	5507MAAP 5507MAAP-FW	Extron® MAAP Faceplate – Accepts four Extron® Electronics MAAP single space modules. 
5507R 5507R-FW	Rectangular Faceplate – Covers rectangular style devices. 	5507-4TJ 5507-4TJFW	Ortronics® Faceplate – Mounts Ortronics® communication inserts. Accepts four TracJack Devices. 
5507S	Rectangular Spacer – Mounts commercial device plates. Installs between the device bracket and a device. 	5507-6TJ 5507-6TJFW	Ortronics® Faceplate – Mounts Ortronics® communication inserts. Accepts six TracJack Devices. 
5507SW 5507SW-FW	Switch Faceplate – Covers standard toggle switches. 	CM-EPLA CM-EPLA-FW	End Plates – Mounts three Pass & Seymour® Activate and Wiremold CM2 Series Open System communication modules into 5507 Series Faceplates. Includes two outlet identification labels with clear covers and two matching screw covers. 
5507T1 5507T1-FW	Single Receptacle Faceplate – Covers single receptacles – 1.59" (40.4mm) diameter. 	S2-EPL S2-EPL-FW	End Plates – Mounts Ortronics® Series II modules into 5507 Series Faceplates. Includes two outlet identification labels with clear covers and two matching screw covers. 
5507T2 5507T2-FW	Single Receptacle Faceplate – Covers single receptacles – 1.41" (35.8mm) diameter. 	5507RJ 5507RJ-FW	Dual RJ11/RJ45 Connector Faceplate – Mounts one or two keystone device modules, has one opening and a KO for the other. 

NOTE: All faceplates have a standard measurement of 4 1/4" x 1 7/8" (108mm x 34mm). Part number without prefix indicates Ivory color, "-FW" suffix indicates Fog White color.

NOTES



Electrical Wiring Systems

60 Woodlawn Street
West Hartford, CT 06110
Phone: 1.877.BY.LEGRAND (295-3472)
www.legrand.us

570 Applewood Crescent
Vaughan, Ontario L4K 4B4
Phone: 905.738.9195
www.legrand.ca

ED874R21 – Updated January 2016 – For latest specs visit www.legrand.us/wiremold



Low Profile, Single & Dual Channel Steel Raceway

2400® Series Raceway is a single compartment raceway designed for communication or power applications and ideal for use in classrooms, offices, and hotel applications, or anywhere a small low profile raceway is needed.

2400D® Series Divided Raceway is a low profile steel raceway for use where a limited number of power and low voltage cables are required in the same raceway.

2400 Series Raceway shown with our new Downward Facing Receptacles in a typical school library application.



FEATURES & BENEFITS

- **Steel raceway.** Provides superior strength for any dry location.
- **Single- and dual-compartment attractive low profile raceway design.** Provides functionality and flexibility with aesthetics for single or dual service applications.
- **Downward facing activations.** Streamlines the raceway appearance and provides increased protection for both activations and cabling.
- **ScuffCoat™ finish.** Tough durable ScuffCoat finish makes a scratch-resistant surface that can be painted.
- **Complete line of fittings.** Provides complete wiring solution and allows for interconnection between raceway systems.
- **Removable cover.** Allows easy access to wiring for changes and additions.
- **One- and two-gang device boxes.** Now you can wire devices into the raceway system, making 2400 Series Raceway an excellent choice for communication wiring.
- **Over the raceway boxes.** Provides tremendous labor savings. Boxes mount over continuous run of raceway base eliminating the need to cut raceway when locating devices.
- **Bend radius control fittings.** Corner and tee fittings are UL verified to maintain full capacity 2" (51mm) bend radius control and exceed the recommendations of EIA/TIA 569A. These fittings provide cable protection in both lay-in and pull-through cable installations.
- **V2475D Bridge Fitting.** Provides ability to bridge 2400 Series Raceways over existing installations of 2400, 700, and 500 Series Raceways.
- **In-line field-configurable receptacles.** Receptacles can be installed at any point along the raceway without a box.
- **In-line 106 frame data outlet.** A wide variety of data modules can be installed anywhere along the raceway run without a box.
- **Communication connectivity options.** Accepts industry standard and proprietary devices from a wide range of manufacturers to provide a seamless and aesthetically pleasing interface for voice, data, audio, and video applications at the point of use.
- **UL and cUL Listed component raceways.** File E4376 Guide RJBT, Fittings: File E41751 Guide RJPR. Meets Article 386 of NEC and meets Section 12-600 of CEC.



Download this product's PEP ecopassport® environmental product declaration at www.legrand.us/resources-and-downloads. This declaration conforms with ISO 14025 and 14040 and is in alignment with EN 15804.



24DWNR Downward Facing Activation shown in a security application.



2400 Series Raceway shown with our new 2444D-2N Divided Device Box in a typical classroom application.

2400 Series Raceway System Layout (Power Applications)

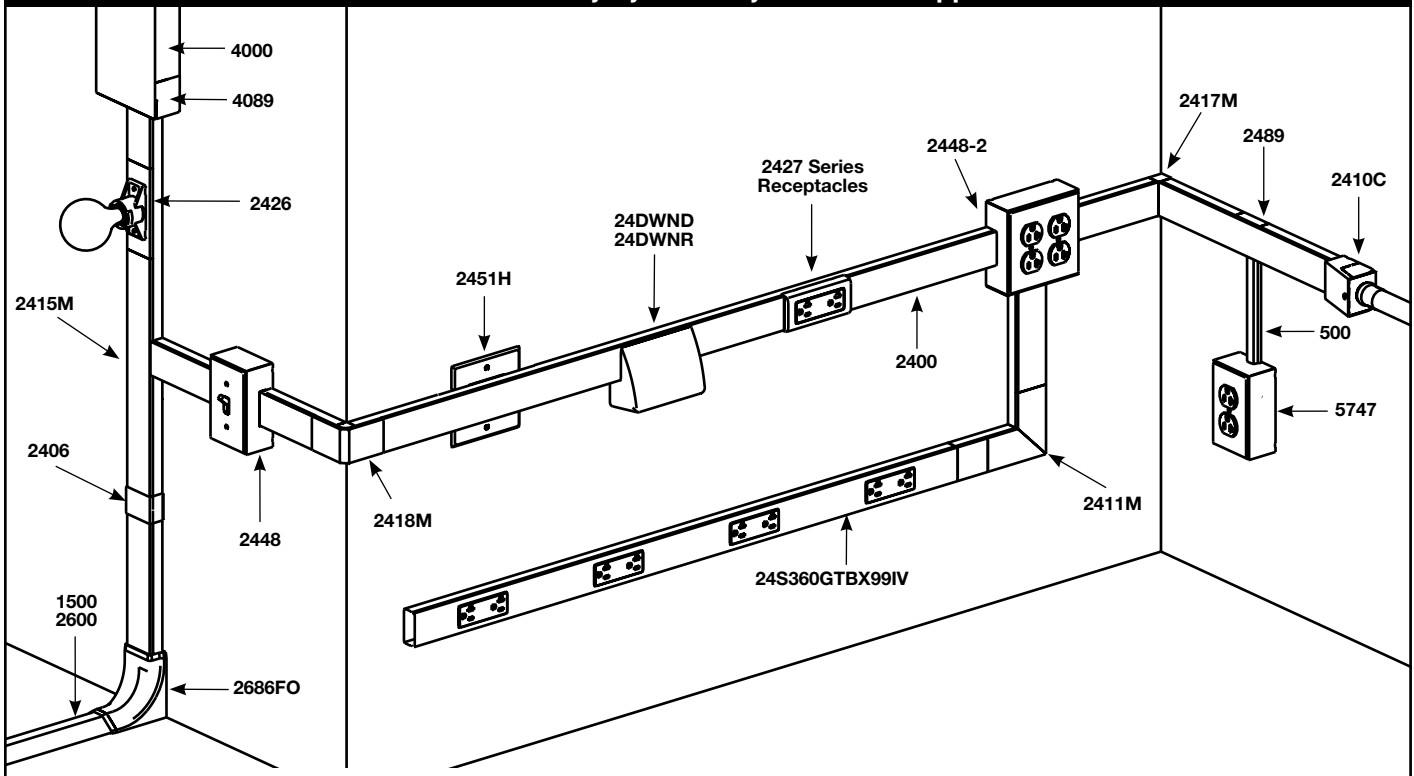

NOTE: Illustration is for product applications and may not represent proper circuit wiring.
Color prefix is not included in part number identification.

2400 Series Raceway System Layout (Communication Applications)

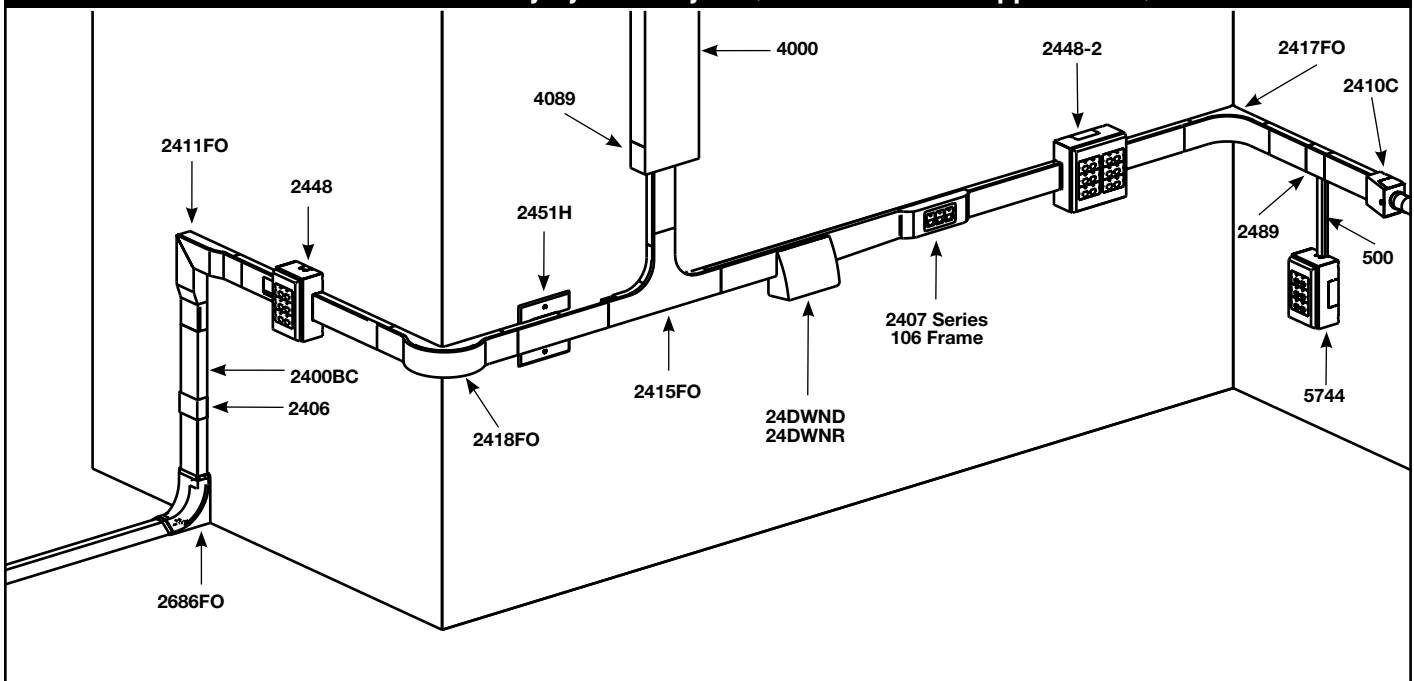

NOTE: Illustration is for product applications and may not represent proper circuit wiring.
Color prefix is not included in part number identification.

2400 Series Raceway Wire Fill Capacity Charts

2400 Raceway Wire Fill Capacities for Power*

WIRE SIZE THHN/THWN	O.D. Inches (mm)		NUMBER OF CONDUCTORS (40% FILL)	
			WITHOUT DEVICES	WITH 2427 RECEPTACLE
14 AWG	0.111	(2.8)	57	12
12 AWG	0.130	(3.3)	41	9
10 AWG	0.164	(4.2)	26	-

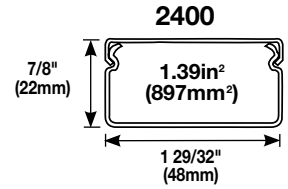



*For additional information, refer to Technical Section in the current version of the Wiremold Catalog.

2400 Raceway Wire Fill Capacities for Communications

CABLE/WIRE SIZE	O.D. (Approx Dia.)		40% FILL**
	Inches	(mm)	
UNSHIELDED TWISTED PAIR	4-Pair, 24 AWG, Cat 3	0.190 (4.8)	19
	4-Pair, 24 AWG, Cat 5e	0.210 (5.3)	16
	4-Pair, 24 AWG, Cat 6	0.250 (6.3)	11
	4-Pair, 24 AWG, Cat 6a	0.354 (8.9)	5
	25-Pair, 24 AWG	0.410 (10.4)	4
COAXIAL	RG6/U	0.270 (6.9)	9
FIBER	ZipCord	0.118 x 0.236 (3 x 6)	20
	Round 4-Strand Fiber	0.187 (4.8)	20
	Round 6-Strand Fiber	0.256 (6.5)	10

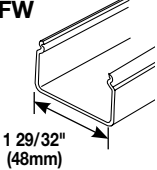
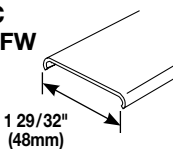
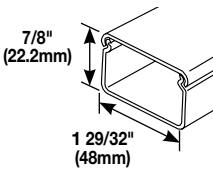
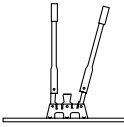
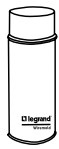
2400 Series Raceway Base & Cover Ordering Information

Catalog No./Item	Description/Specifications	Catalog No./Item	Description/Specifications
V2400B V2400B-10 2400B-FW 2400B-10FW	Raceway Base – .040" (1.0mm) steel; packed twenty 5' (1.5m) lengths per carton, or ten 10' (3.0m) lengths per carton.	V2400C 2400C-FW	Raceway Cover – .040" (1.0mm) steel; packed twenty 5' (1.5m) lengths per carton.
			
V2400BC 2400BC-FW	Raceway Base & Cover – .040" (1.0mm) steel. Packed ten 5' (1.5m) lengths of base and cover per carton.	624	2400 Raceway Base & Cover Cutter – Portable cutter for 2400 & 2400D Series Raceway Base and Cover. Provides a clean and easy square cut every time.
			
NOTE: "V" prefix indicates Ivory color, "-FW" suffix indicates Fog White color.		624BCK	Replacement Blade Kit – Replacement blades and die set for 624 Cutter.
		IWE-S DVWE-S	Spray Paint – Used for touching up large areas. Available in Ivory (IWE-S) or Fog White (DVWE-S). Contains 12 oz. of paint.
			NOTE: Can only be shipped via ground transportation.
		IWE-P DVWE-P	Touch-Up Paint Pen – Used for touching up small areas. Available in Ivory (IWE-P) or Fog White (DVWE-P). Contains 0.3 oz. of paint.
			

2400 Series Raceway Fittings Ordering Information

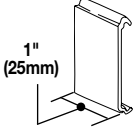
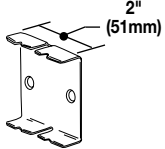
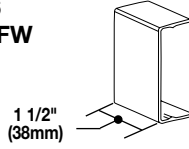
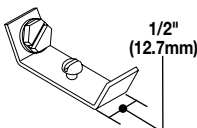
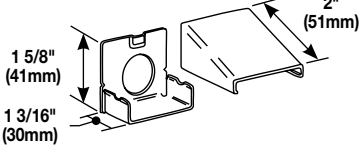
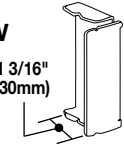
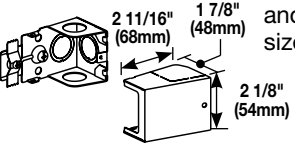
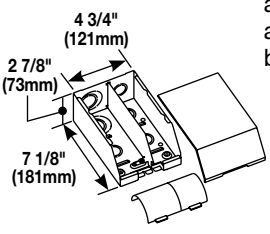
Catalog No./Item	Description/Specifications
2400WC 	Wire Clip – Additional support for conductors in 2400 Series Raceway. (Nonmetallic)
2401 	Coupling – Joins sections of 2400B Base.
V2406 2406-FW 	Cover Clip – Covers joints where sections of 2400 Series Raceway cover or base come together. Nonmetallic construction.
2409 	Ground Clamp – Connects equipment grounding conductor to 2400 Series Raceway. No. 10 ground screw provided.
V2410A 2410A-FW 	Entrance End Fitting – Connects 2400 Series Raceway with 1/2" trade size conduit or armored cable.
V2410B 2410B-FW 	Blank End Fitting – Closes off open end of 2400 Series Raceway.
V2410C 2410-FW 	Entrance End Fitting – Feeds 2400 Series Raceway. Includes 1/2" and 3/4" trade size KOs on end and bottom. Additional 1/2" trade size KO on both sides.
V2410DFO 2410DFO-FW 	Divided Entrance End Fitting – Feeds 2400 & 2400D Series Raceway. Includes 1/2", 3/4", and 1" trade size KOs on back and end. Removable divider and bend radius control insert included.

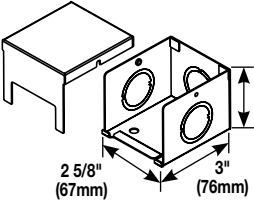
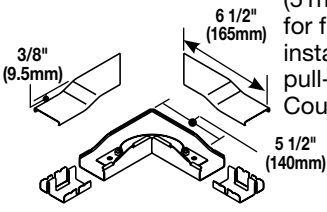
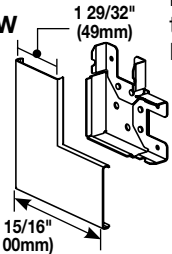
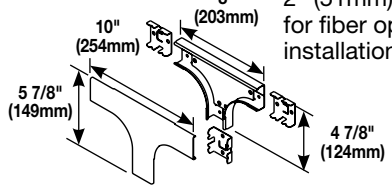
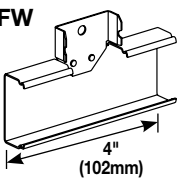
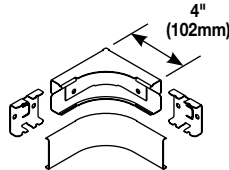
Catalog No./Item	Description/Specifications
V2410FC 2410FC-FW 	Full Capacity Entrance End Fitting – Feeds 2400 Series Raceway. Includes three 3/4" and 1" concentric trade size KOs.
V2411FO 2411FO-FW 	Radiused Flat Elbow – 90° flat corner that provides 2" (51mm) cable bend radius control for fiber optic and UTP/STP cable installations. Ideal for lay-in or pull-through installations. Couplings included.
V2411M 2411M-FW 	Flat Elbow – Makes right angle turns in runs of 2400 Series Raceway on same surface.
V2415FO 2415FO-FW 	Radiused Tee – Branches at right angles. Provides a controlled 2" (51mm) cable bend radius control for fiber optic and UTP/STP cable installations. Couplings included.
V2415M 2415M-FW 	Tee – Branches at right angles. Couplings included.
V2417FO 2417FO-FW 	Radiused Internal Elbow – 90° internal corner. Provides a controlled 2" (51mm) cable bend radius control for fiber optic and UTP/STP cable installations. Couplings included.

NOTE: "V" prefix indicates Ivory color, "-FW" suffix indicates Fog White color.

2400 Series Raceway Fittings Ordering Information (continued)

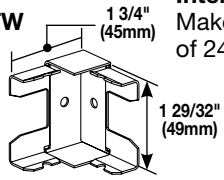
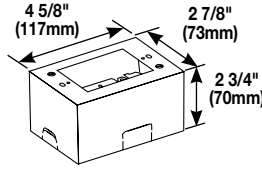
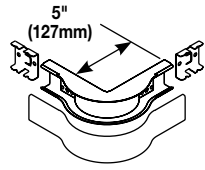
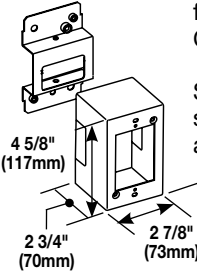
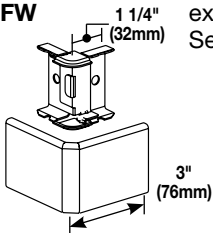
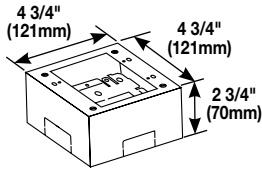
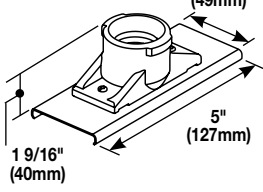
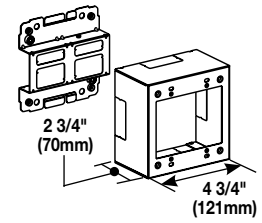
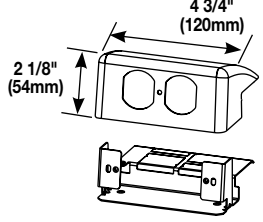
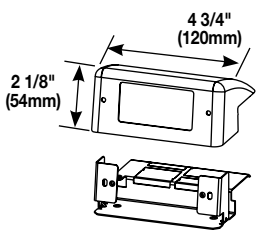
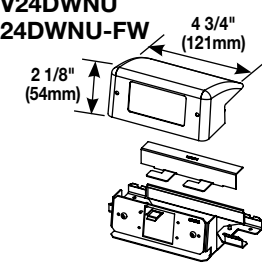
Catalog No./Item	Description/Specifications	Catalog No./Item	Description/Specifications
V2417M 2417M-FW 	Internal Elbow – Makes 90° internal corners in runs of 2400 Series Raceway.	V2444 2444-FW 	Extra Deep Device Box – One-gang device box has extra depth to permit installation of cabling that requires greater bend radius and storage. Cover has one twistout for 2400 Series Raceway on two sides and one twistout for 500 and 700 Series Raceway on the top and bottom. Accepts industry standard faceplates for electrical and communication devices.
V2418FO 2418FO-FW 	Radiused External Elbow – 90° external elbow. Provides a controlled 2" (51mm) cable bend radius control for fiber optic and UTP/STP cable installations. Couplings included.	V2444D 2444D-FW 	Device Box – One-gang, labor saving, over-the-raceway box for use with 2400 Series Raceway. Cover has two twistouts for 2400 Series Raceway. Accepts industry standard faceplates for electrical and communication devices.
V2418M 2418M-FW 	External Elbow – Makes 90° external corners in runs of 2400 Series Raceway.	V2444-2 2444-2FW 	Extra Deep Device Box – Two-gang device box has extra depth to permit installation of cabling that requires greater bend radius and storage. Cover has four twistouts for 2400 Series Raceway. Base includes knockout to enable extension from existing single-gang flush wall box and 1/2" and 1" concentric trade size KOs. Accepts industry standard faceplates for electrical and communication devices.
V2426 2426-FW 	Lamp Holder – Medium base lamp holder 660W, 250V. Black general purpose phenolic.	V2444-2LS 2444-2LSFW 	Device Box – Two-gang, labor saving, over-the-raceway box for use with 2400 Series Raceway. Cover has four twistouts for 2400 Series Raceway. Accepts industry standard faceplates for electrical and communication devices.
V24DWND 24DWND-FW 	Downward Duplex Device Bracket – Labor saving, over-the-raceway device bracket. For 15A or 20A duplex receptacles or 106 style data frame in 2400 Series Raceway.	V24DWNU 24DWNU-FW 	Downward Extron® MAAP Device Plate – Accepts two Extron® Electronics MAAP single space modules.
V24DWRN 24DWRN-FW 	Downward Decorator Device Bracket – Labor saving over-the-raceway device bracket. For 15A or 20A decorator/GFCI receptacles or decorator style data frame in 2400 Series Raceway.		

NOTE: "V" prefix indicates Ivory color, "-FW" suffix indicates Fog White color.

2400 Series Raceway Fittings Ordering Information (continued)

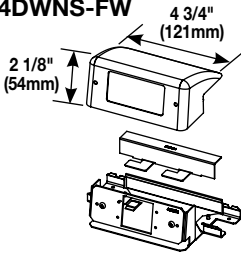
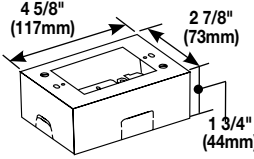
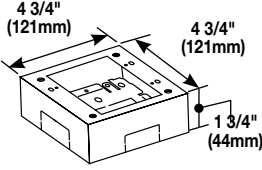
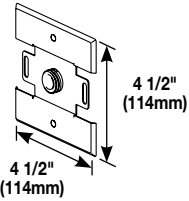
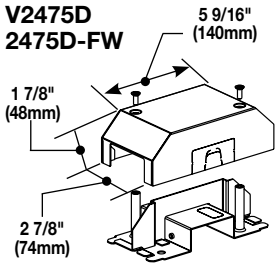
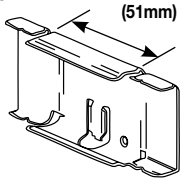
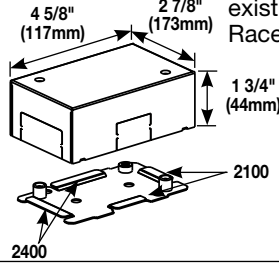
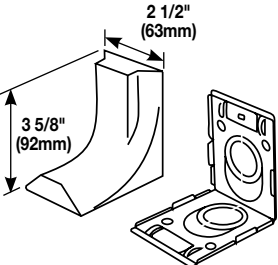
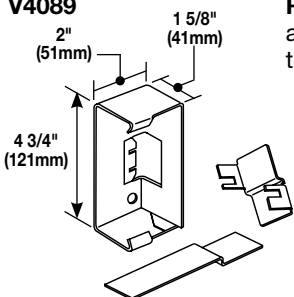
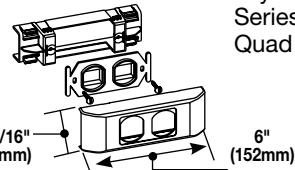
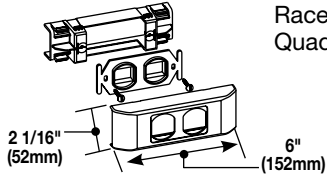
Catalog No./Item	Description/Specifications
<p>V24DWNS 24DWNS-FW</p> 	<p>Downward Ortronics® Series II Device Plate – Accepts one Ortronics® Series II module.</p>
<p>V2448 2448-FW</p> 	<p>Device Box – One-gang device box. Cover has one twistout for 2400 Series Raceway on two sides and one twistout for 500 and 700 Series Raceway on the top and bottom. Base includes knockout to enable extension from existing single-gang flush wall box and 1/2" trade size KOs. Accepts industry standard faceplates for electrical and communication devices.</p>
<p>V2448-2 2448-2FW</p> 	<p>Device Box – Two-gang device box. Cover has four (4) twistout for 2400 Series Raceway. Base includes knockout to enable extension from existing single-gang flush wall box and 1/2" trade size KOs. Accepts industry standard faceplates for electrical and communication devices.</p>
<p>V2451H 2451H-FW</p> 	<p>Back Feed Fitting – Feeds 2400 Series Raceway from an existing outlet box. Equipped with 1/2" trade size male bushing and lock nut washer for grounding.</p>
<p>V2475D 2475D-FW</p> 	<p>Bridge Fitting – Allows 2400 Series Raceway to bridge over existing installations of 2400, 500, or 700 Series Raceways.</p>
<p>V2489</p> 	<p>Side Reducing Connector – Connects 2400 Series Raceway with 500 Series Raceway.</p>
<p>V2489TB</p> 	<p>Transition Box – Connects existing installations of 2100 Series Raceway to 2400 Series Raceway.</p>
<p>2686FO</p> 	<p>Transition Feed Fitting – Eliminates offsetting of 2400 Series Raceway in connecting with surface panel boxes. Has 3/4" and 1" concentric trade size KOs with 1" trade size KO elongated so adjustment from surface to center of bushing is 1" (25mm) minimum to 1 5/8" (41mm) maximum. Has twistouts for transition to 1500 and 2600 Series Pancake Raceways.</p>
<p>V4089</p> 	<p>Reducing Connector – Reduces and connects 4000 Series Raceway to 2400 Series Raceway.</p>
<p>V2407-2CM 2407-2CMFW</p> 	<p>106 Device Bracket and Frame – Installs two network wiring keystone device modules in 2400 Series Raceway. Does not support Quad 106 Frame.</p>
<p>V2407-2TJ 2407-2TJFW</p> 	<p>106 Device Bracket and Frame – Installs two Ortronics TracJack device modules in 2400 Series Raceway. Does not support Quad 106 Frame.</p>

NOTE: "V" prefix indicates Ivory color, "-FW" suffix indicates Fog White color.

2400 Series Raceway Receptacles Ordering Information

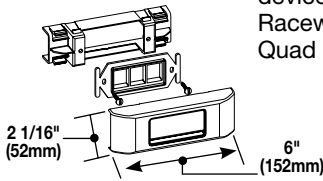
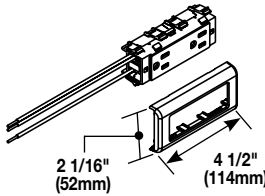
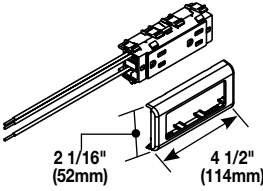
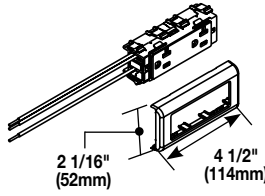
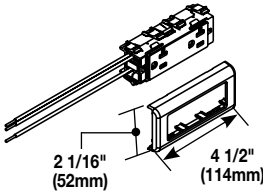
Catalog No./Item	Description/Specifications	Catalog No./Item	Description/Specifications
V2407-3TJ 2407-3TJFW 	106 Device Bracket and Frame – Installs three Ortronics TracJack device modules in 2400 Series Raceway. Does not support Quad 106 Frame.	IG2427GA 	15A Isolated Ground Duplex Receptacle – 3-Wire 125V NEMA 5-15R orange receptacle provided with 10-1/2" (267mm) pigtails and inline splice connectors.
V2427GA 	15A Duplex Receptacle – 3-Wire 125V NEMA 5-15R receptacle provided with 10-1/2" (267mm) pigtails and inline splice connectors.	IG2427GT 	20A Isolated Ground Duplex Receptacle – 3-Wire 125V NEMA 5-20R orange receptacle provided with 10-1/2" (267mm) pigtails and inline splice connectors.
V2427GT 	20A Duplex Receptacle – 3-Wire 125V NEMA 5-20R receptacle provided with 10-1/2" (267mm) pigtails and inline splice connectors.	NOTE: "V" prefix indicates Ivory color, "-FW" suffix indicates Fog White color.	

2400D Series Divided Raceway System Layout for Power & Data

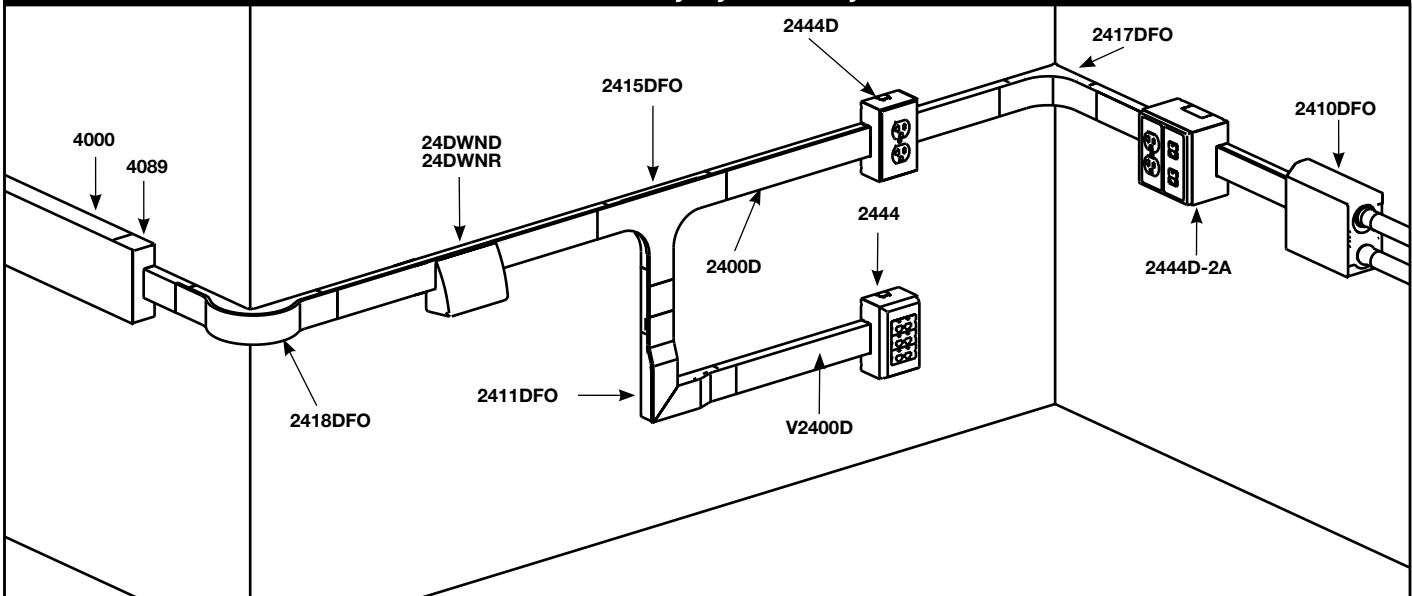

NOTE: Illustration is for product applications and may not represent proper circuit wiring.
 Color prefix is not included in part number identification.

2400D Series Divided Raceway Wire Fill Capacities

2400D Series Divided Raceway Wire Fill Capacities for Power

WIRE SIZE THHN/THWN	O.D.		NUMBER OF CONDUCTORS (40% FILL)	
	Inches	(mm)	1/3 COMP.	2/3 COMP.
14 AWG	0.111	(2.8)	11	26
12 AWG	0.130	(3.3)	9	19
10 AWG	0.164	(4.2)	6	11

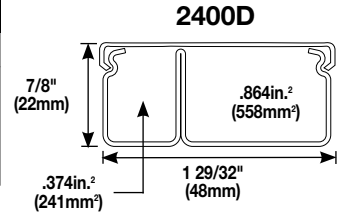



*For additional information refer to Technical Section of Wiremold Product Guide.

2400D Series Divided Raceway Wire Fill Capacities for Communications

CABLE/WIRE SIZE		O.D. (Approx Dia.)		1/3 COMPARTMENT	2/3 COMPARTMENT
		Inches	(mm)	40% FILL	40% FILL**
UNSHIELDED TWISTED PAIR	4-Pair, 24 AWG, Cat 3	0.190	(4.8)	5	12
	4-Pair, 24 AWG, Cat 5e	0.210	(5.3)	4	9
	4-Pair, 24 AWG, Cat 6	0.250	(6.3)	3	7
	4-Pair, 24 AWG, Cat 6a	0.354	(8.9)	1	3
	25-Pair, 24 AWG	0.410	(10.4)	1	2
COAXIAL	RG6/U	0.270	(6.9)	2	6
FIBER	ZipCord	0.118 x 0.236	(3 x 6)	5	12
	Round 4-Strand Fiber	0.187	(4.8)	5	12
	Round 6-Strand Fiber	0.256	(6.5)	2	6

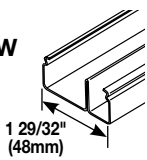
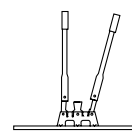
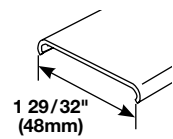
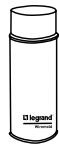
2400D Series Divided Raceway Base & Cover Ordering Information

Catalog No./Item	Description/Specifications	Catalog No./Item	Description/Specifications
V2400BD 2400BD-FW	 Divided Raceway Base – .040" (1.0mm) steel; divided into 1/3 and 2/3 compartments. Packed ten 10' (3.0m) lengths per carton.	624	 2400 Raceway Base & Cover Cutter – Portable cutter for 2400 & 2400D Series Raceway Base and Cover. Provides a clean and easy square cut every time.
V2400C 2400C-FW	 Raceway Cover – .040" (1.0mm) steel; packed twenty 5' (1.5m) lengths per carton.	624BCK	Replacement Blade Kit – Replacement blades and die set for 624 Cutter.
		IWE-S DVWE-S	 Spray Paint – Used for touching up large areas. Available in Ivory (IWE-S) or Fog White (DVWE-S). Contains 12 oz. of paint. NOTE: Can only be shipped via ground transportation.
		IWE-P DVWE-P	 Touch-Up Paint Pen – Used for touching up small areas. Available in Ivory (IWE-P) or Fog White (DVWE-P). Contains 0.3 oz. of paint.

NOTE: "V" prefix indicates Ivory color, "-FW" suffix indicates Fog White color.

2400D Series Divided Raceway Fittings (continued)

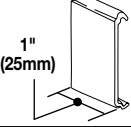
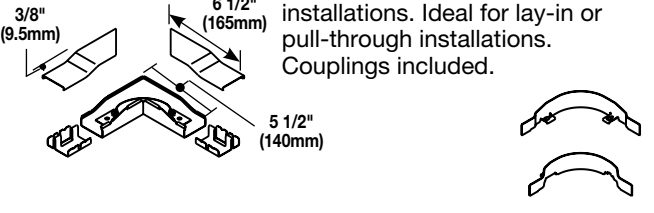
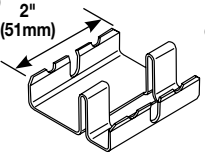
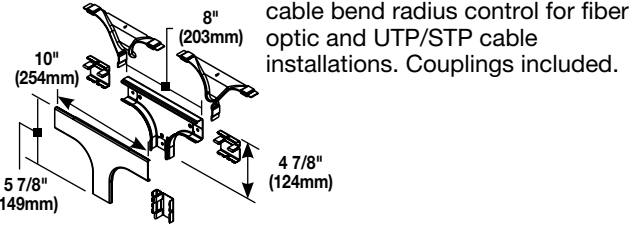
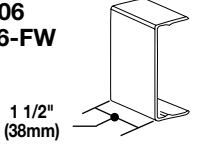
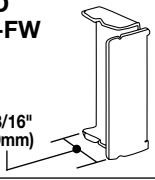
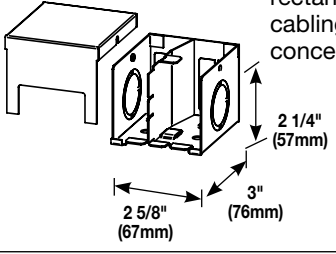
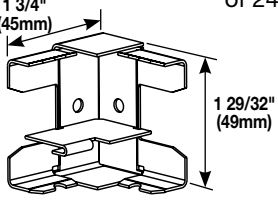
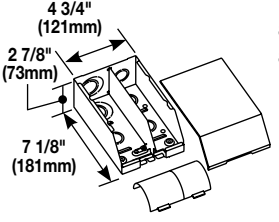
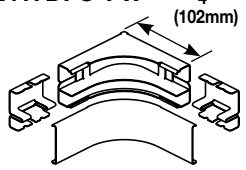
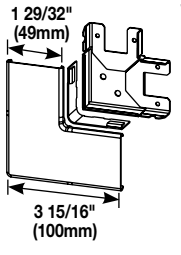
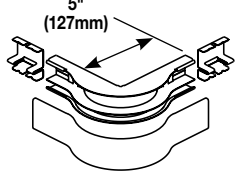
Catalog No./Item	Description/Specifications	Catalog No./Item	Description/Specifications
2400WC 	Wire Clip – Additional support for conductors in 2400D Series Raceway. (Nonmetallic)	V2411DFO 2411DFO-FW 	Radiused Divided Flat Elbow – 90° flat elbow with integral dividers to provide 2" (51mm) full capacity cable bend radius control for fiber optic and UTP/STP cable installations. Ideal for lay-in or pull-through installations. Couplings included.
2401D 	Divided Coupling – Joins sections of 2400DB Divided Base.	V2415DFO 2415DFO-FW 	Radiused Divided Tee – For branches at right angles. Provides 2" (51mm) full capacity cable bend radius control for fiber optic and UTP/STP cable installations. Couplings included.
V2406 2406-FW 	Cover Clip – Covers joints where sections of 2400 Series Raceway cover or base come together. Nonmetallic construction.	V2417D 2417D-FW 	Divided Internal Elbow – Makes internal 90° corners in runs of 2400D Series Raceway.
V2410BD 2410BD-FW 	Divided Blank End Fitting – Closes off open end of 2400D Series Raceway.	V2417DFO 2417DFO-FW 	Radiused Divided Internal Elbow – 90° internal corner. Provides a 2" (51mm) full capacity cable bend radius control for fiber optic and UTP/STP cable installations. Couplings included.
V2410D 2410D-FW 	Divided Entrance End Fitting – Feeds 2400D Series Raceway. Two 1/2" trade size KOs and two rectangular KOs for communication cabling. Two additional 1" and 3/4" concentric trade size KOs on sides.	V2418DFO 2418DFO-FW 	Radiused Divided External Elbow – 90° external elbow. Provides a 2" (51mm) full capacity cable bend radius control for fiber optic and UTP/STP cable installations. Couplings included.
V2410DFO 2410DFO-FW 	Divided Entrance End Fitting – Feeds 2400 & 2400D Series Raceway. Includes 1/2", 3/4", and 1" trade size KOs on back and end. Removable divider and bend radius control insert included.	V2411D 2411D-FW 	Divided Flat Elbow – Makes right angle turns in runs of 2400D Series Raceway on same surface.

NOTE: "V" prefix indicates Ivory color, "-FW" suffix indicates Fog White color.

2400 Series Divided Raceway Fittings Ordering Information (continued)

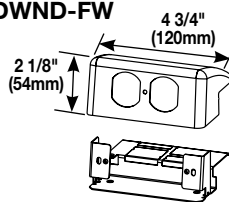
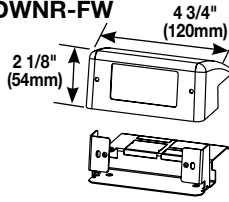
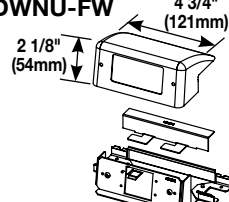
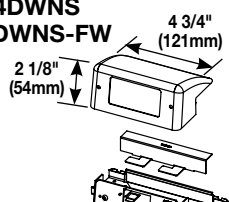
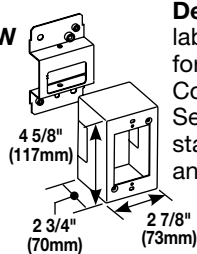
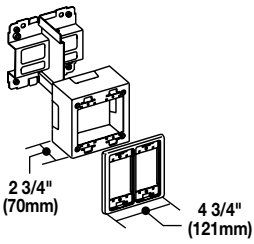
Catalog No./Item	Description/Specifications
V24DWND 24DWND-FW 	Downward Duplex Device Bracket – Labor saving over-the-raceway device bracket. For 15A or 20A duplex receptacles or 106 style data frame in 2400D Series Raceway.
V24DWNR 24DWNR-FW 	Downward Decorator Device Bracket – For 15A and 20A decorator/GFCI receptacles or 106 style data frame in 2400D Series Raceway.
V24DWNU 24DWNU-FW 	Downward Extron® MAAP Device Plate – Accepts two Extron® Electronics MAAP single space modules. Raceway base must be cut.
V24DWNS 24DWNS-FW 	Downward Ortronics® Series II Device Plate – Accepts one Ortronics® Series II module. Raceway base must be cut.
V2444D 2444D-FW 	Device Box – One-gang, labor saving, over-the-raceway box for use with 2400D Series Raceway. Cover has two twistouts for 2400D Series Raceway. Accepts industry standard faceplates for electrical and communication devices.
V2444D-2A 2444D-2AFW 	Divided Device Box – Divided two-gang, labor saving, over-the-raceway box for use with 2400D Series Raceway. Provides the ability to have both power and low voltage at a single point-of-use. Accepts 5507 Series Faceplates, Ortronics® TracJack & Series II Modules (requires S2-EPL Plate), Pass & Seymour Activate Series Inserts (requires CM-EPLA Plate) and Wiremold CM2 Series Open System Communication Modules (requires CM-EPLA Plate).

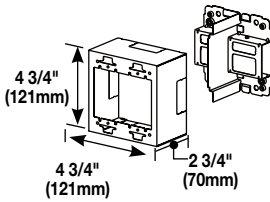
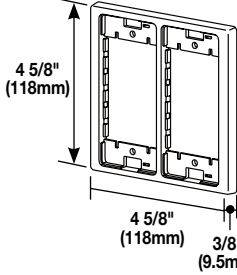
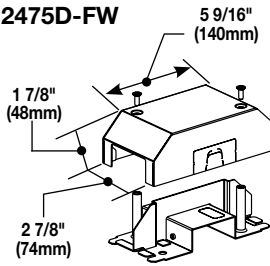
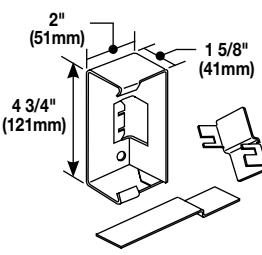
Catalog No./Item	Description/Specifications
V2444D-2N 2444D-2NFW 	Divided Box – Labor savings over-the-raceway box. A divided two-gang box for use with 2400D Series Raceway. Allows both power and low voltage at a single point-of-use. For use with commercially available faceplates (not supplied).
V2450 2450-FW 	Device Bracket – For use with 2444D-2N for both power and low voltage at a single point of use. Accepts 5507 Series Faceplates, Ortronics® TracJack & Series II Modules (requires S2-EPL Plate), Pass & Seymour Activate Series Inserts (requires CM-EPLA Plate) and Wiremold CM2 Series Open System Communication Modules (requires CM-EPLA Plate).
V2475D 2475D-FW 	Bridge Fitting – For allowing 2400D Series Raceway to bridge over existing installations of 2400, 2400D, 500, and 700 Series Raceways.
V4089 	Reducing Connector – For reducing from 4000 Series Raceway to 2400D Series Raceway.

NOTE: "V" prefix indicates Ivory color, "-FW" suffix indicates Fog White color.

5507 Series Faceplates Ordering Information

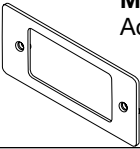
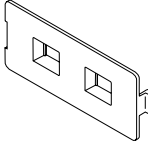
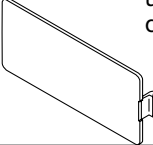
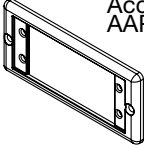
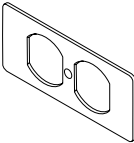
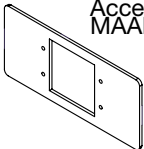
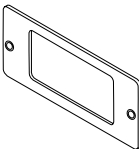
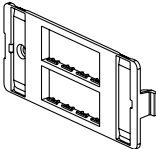
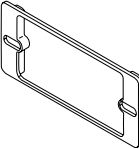
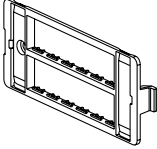
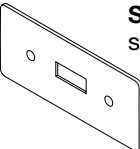
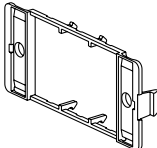
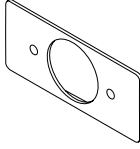
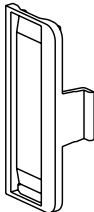
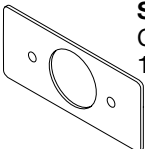
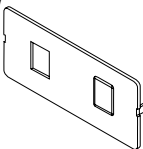
Catalog No./Item	Description/Specifications	Catalog No./Item	Description/Specifications
5507AD 5507AD-FW	Modular Furniture Adapter – Accepts modular furniture adapters. 	5507FRJ 5507FRJ-FW	Flush Dual RJ11/RJ45 Faceplate – Mounts one or two keystone device modules, recessed to provide a flush installation. Has one opening and a KO for the other. 
5507B 5507B-FW	Blank Faceplate – Covers unused compartments in the device bracket. 	5507AAP 5507AAP-FW	Extron® AAP Faceplate – Accepts two Extron® Electronics AAP single space modules. 
5507D 5507D-FW	Duplex Faceplate – Covers duplex style devices. Accepts 106 Frame. 	5507MAAP 5507MAAP-FW	Extron® MAAP Faceplate – Accepts four Extron® Electronics MAAP single space modules. 
5507R 5507R-FW	Rectangular Faceplate – Covers rectangular style devices. 	5507-4TJ 5507-4TJFW	Ortronics® Faceplate – Mounts Ortronics® communication inserts. Accepts four TracJack Devices. 
5507S	Rectangular Spacer – Mounts commercial device plates. Installs between the device bracket and a device. 	5507-6TJ 5507-6TJFW	Ortronics® Faceplate – Mounts Ortronics® communication inserts. Accepts six TracJack Devices. 
5507SW 5507SW-FW	Switch Faceplate – Covers standard toggle switches. 	CM-EPLA CM-EPLA-FW	End Plates – Mounts three Pass & Seymour® Activate and Wiremold CM2 Series Open System communication modules into 5507 Series Faceplates. Includes two outlet identification labels with clear covers and two matching screw covers. 
5507T1 5507T1-FW	Single Receptacle Faceplate – Covers single receptacles – 1.59" (40.4mm) diameter. 	S2-EPL S2-EPL-FW	End Plates – Mounts Ortronics® Series II modules into 5507 Series Faceplates. Includes two outlet identification labels with clear covers and two matching screw covers. 
5507T2 5507T2-FW	Single Receptacle Faceplate – Covers single receptacles – 1.41" (35.8mm) diameter. 		
5507RJ 5507RJ-FW	Dual RJ11/RJ45 Connector Faceplate – Mounts one or two keystone device modules, has one opening and a KO for the other. 		

NOTE: All faceplates have a standard measurement of 4 1/4" x 1 7/8" (108mm x 34mm). Part number without prefix indicates Ivory color, "-FW" suffix indicates Fog White color.

NOTES



Electrical Wiring Systems

60 Woodlawn Street
West Hartford, CT 06110
Phone: 1.877.BY.LEGRAND (295-3472)
www.legrand.us

570 Applewood Crescent
Vaughan, Ontario L4K 4B4
Phone: 905.738.9195
www.legrand.ca

ED874R21 – Updated January 2016 – For latest specs visit www.legrand.us/wiremold

