

MODEL 690 BATH FAN UPGRADE KIT

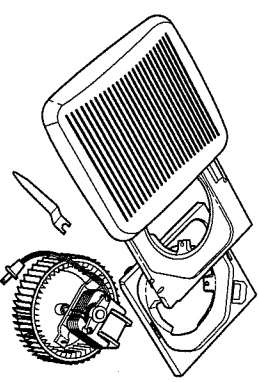

Reduces the sound level of your existing bath fan by up to **50%** while increasing air movement by up to **20%**. No rewiring or new ductwork required.

TYPICAL SPECIFICATION

Bath Fan Upgrade Kit shall be Broan Model 690. Bath Fan Upgrade Kit shall include two galvanized steel motor plates designed to accommodate a variety of economy fan models.

FEATURES

GRILLE:

- White polymeric - blends well with any decor
- Torsion spring grille mounting - no tools required

FAN ASSEMBLY:

- Plug-in, permanently lubricated motor
- Broan-designed polymeric blower wheel
- Galvanized steel motor bracket and motor plate
- Fits into your existing bath fan housing
- Two motor plate sizes included - to accommodate a variety of economy fan models

ACCESSORIES:

- Wrench and hardware included - no additional tools required
- Polymeric scroll band included - enhances performance of existing bath fan housings

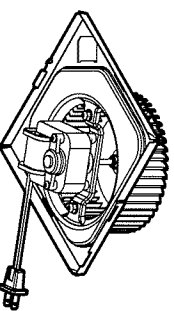

Motor shall be removable and permanently lubricated. Air delivery shall be no less than 60 cfm and sound level no greater than 3.0 Sones. All air and sound ratings shall be certified by HVI. Unit shall be U.L. Listed.

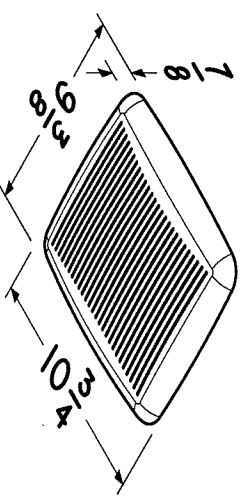

| VOLTS | AMPS | CFM | SONES |
|-------|------|-----|-------|
| 120 | 1.2 | 60 | 3.0 |



For use only with these bath fan models:

- | | | |
|---|---------------------------------|---|
|  | Broan 670, 671, 688, 689 | The kit will work if your housing measures $7\frac{1}{2}'' \times 7\frac{1}{4}''$. |
|  | Nautilus N671, N688 | The kit will work if your housing measures $7\frac{1}{2}'' \times 7\frac{1}{4}''$. |
|  | NuTone 693, 695, 696N | The kit will work if your housing measures either $7\frac{1}{2}'' \times 7\frac{1}{4}''$ or $8'' \times 7\frac{1}{4}''$. |

HVI 21001 CERTIFIED
 HVI2100 CERTIFIED RATINGS comply with new testing technologies and procedures prescribed by the Home Ventilating Institute, for off-the-shelf products, as they are available to consumers. Product performance is rated at 0.1 in. static pressure, based on tests conducted in AWCAs state-of-the-art test laboratory. Sones are a measure of humanly-perceived loudness, based on laboratory measurements.

Broan-NuTone LLC, 926 West State Street, Hartford, WI 53027 (1-800-637-1453)

| REFERENCE | QTY. | REMARKS |
|--------------|------|---------|
| | | |
| Project | | |
| Location | | |
| Architect | | |
| Engineer | | |
| Contractor | | |
| Submitted by | | Date |

MODEL 690 BATH FAN UPGRADE KIT

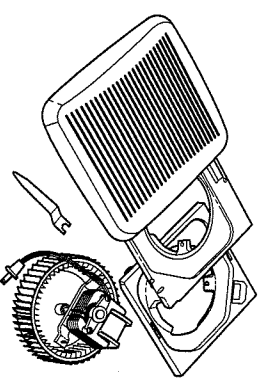

Reduces the sound level of your existing bath fan by up to 50% while increasing air movement by up to 20%. No rewiring or new ductwork required.

FEATURES

GRILLE:

- White polymeric - blends well with any decor
- Torsion spring grille mounting - no tools required

FAN ASSEMBLY:

- Plug-in, permanently lubricated motor
- Broan-designed polymeric blower wheel
- Galvanized steel motor bracket and motor plate
- Fits into your existing bath fan housing
- Two motor plate sizes included - to accommodate a variety of economy fan models

ACCESSORIES:

- Wrench and hardware included - no additional tools required
- Polymeric scroll band included - enhances performance of existing bath fan housings

SPECIFICATIONS

| VOLTS | AMPS | CFM | SONES |
|-------|------|-----|-------|
| 120 | 1.2 | 60 | 3.0 |

For use only with these bath fan models:



Broan 670, 671, 688, 689
The kit will work if your housing measures 7 $\frac{1}{2}$ " x 7 $\frac{1}{4}$ ".



Nautilus N671, N688
The kit will work if your housing measures 7 $\frac{1}{2}$ " x 7 $\frac{1}{4}$ ".



NuTone 693, 695, 696N
The kit will work if your housing measures either 7 $\frac{1}{2}$ " x 7 $\frac{1}{4}$ " or 8" x 7 $\frac{1}{4}$ ".

Broan-NuTone LLC, 926 West State Street, Hartford, WI 53027 (1-800-637-1453)

TYPICAL SPECIFICATION

Bath Fan Upgrade Kit shall be Broan Model 690. Bath Fan Upgrade Kit shall include two galvanized steel motor plates designed to accommodate a variety of economy fan models.

Motor shall be removable and permanently lubricated.

Air delivery shall be no less than 60 cfm and sound level no greater than 3.0 Sones. All air and sound ratings shall be certified by HVI. Unit shall be U.L. Listed.

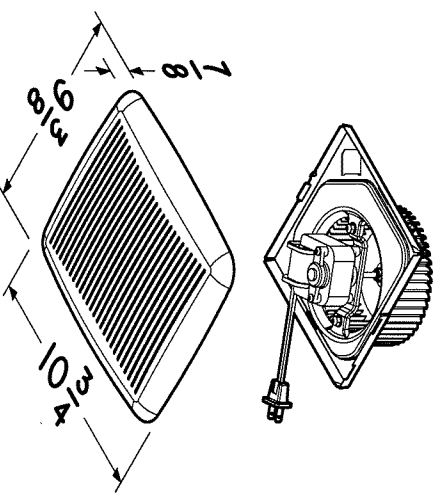

HVI-2100 CERTIFIED RATINGS comply with new testing technologies and procedures prescribed by the Home Ventilating Institute, for off-the-shelf products, as they are available to consumers. Product performance is rated at 0.1 in. static pressure, based on tests conducted in AWC's state-of-the-art test laboratory. Sones are a measure of humanly-perceived loudness, based on laboratory measurements.

| REFERENCE | QTY. | REMARKS | Project |
|-----------|------|---------|--------------|
| | | | Location |
| | | | Architect |
| | | | Engineer |
| | | | Contractor |
| | | | Submitted by |
| | | | Date |