

DESCRIPTION

The SSF Series is a functional and multi-purpose standard strip family that incorporates premium performance and construction durability. Designed with our easy-to-use Flip-Up socket design, the SSF significantly reduces installation time. The performance and application versatility of this series can be increased by incorporating symmetrical or asymmetrical reflectors. The SSF Series can be installed using various mounting methods and numerous options and accessories are available.

Catalog #		Type
Project		
Comments		Date
Prepared by		

SPECIFICATION FEATURES

Construction

Channel die formed cold rolled steel with numerous KOs for ease of installation. Groove for Tong Hanger. End plate quickly converts to snap-in channel connector for continuous row alignment. Lamp holder bracket flips in place. Channel/wireway cover secured with quarter-turn fasteners.

Channel/Wireway Cover

Die formed heavy gauge steel. Tight fit for ease of maintenance. Easily removed without use of tools. Optional reflector available

incorporating silver technology enhancements. (Silver Lining) Consult Pre Sales Technical Support.

Electrical*

Ballasts are CBM/ETL Class "P" and are positively secured by mounting bolts. Rotor Lock lampholders. UL/CUL listed. Suitable for damp locations.

Finish

Multistage iron phosphate pretreatment ensures maximum bonding and rust inhibitor. Lighting

upgrade, baked white enamel finish. Prepainted material is standard, PAF optional.

Application

The SSF Series can be the illumination solution in commercial, industrial, retail and residential applications. Fixtures can be used in storage/utility areas, coves, display cases, shops, task and general area lighting.



SSF
 114T5
 124T5
 128T5
 154T5
 214T5
 224T5
 228T5
 254T5
 328T5
 354T5

2' OR 4' STRIP
1, 2 OR 3 T5 OR T5HO LAMPS

Standard Striplite

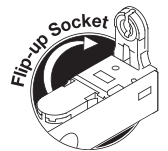

LAMP CONFIGURATIONS

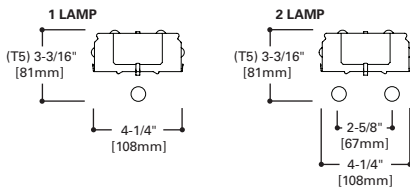

MOUNTING DATA

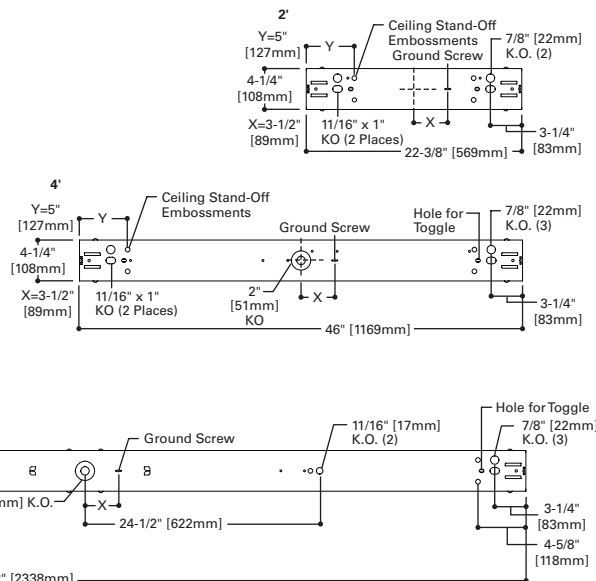

ENERGY DATA

Input Watts:
Electronic Ballast & Standard Lamps
 114 (19), 124 (25)
 128 (34), 154 (54)
 214 (38), 224 (52)
 228 (68), 254 (106)
 328 (97), 354 (182)

*Reference the lamp/ballast data in the Technical Section for specific lamp/ballast requirements.

LAMPS CONTAIN MERCURY. DISPOSE ACCORDING TO LOCAL, STATE OR FEDERAL LAWS

LINEAR DISCONNECT

Safe and convenient means of disconnecting power.



PHOTOMETRICS

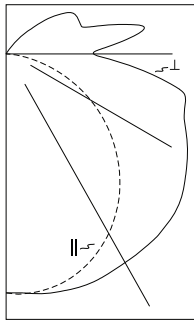

SSF-228T5-UNV-EBT1
Electronic Ballast
F28T5/835 Lamps
2600 Lumens
Spacing criterion:
(||) 1.3 x mounting
height, (⊥) 1.5 x
mounting height
Efficiency 96.5%
Test Report: 122P106
LER = FS
Yearly Cost of 1000
lumens, 3000 hrs at
.08 KWH = \$

Candlepower

Angle	Along	45°	Across ⊥
0	973	973	973
5	979	979	978
10	972	982	990
15	955	977	994
20	926	964	995
25	887	945	987
30	840	920	978
35	783	887	971
40	720	853	964
45	650	821	950
50	574	787	927
55	496	749	890
60	414	699	852
65	330	639	812
70	244	586	772
75	161	535	756
80	87	506	670
85	29	373	494
90	1	223	345

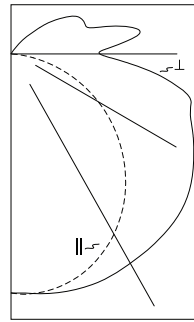

SSF-254T5-UNV-EBT1
Electronic Ballast
F54T5/835 Lamps
4400 Lumens
Spacing criterion:
(||) 1.3 x mounting
height, (⊥) 1.5 x
mounting height
Efficiency 97.3%
Test Report: 122P108
LER = FS-
Yearly Cost of 1000
lumens, 3000 hrs at
.08 KWH = \$

Candlepower

Angle	Along	45°	Across ⊥
0	1661	1661	1661
5	1672	1672	1670
10	1661	1675	1689
15	1631	1666	1698
20	1584	1647	1699
25	1518	1616	1690
30	1439	1575	1674
35	1345	1521	1661
40	1239	1461	1645
45	1122	1405	1623
50	997	1348	1589
55	867	1285	1535
60	731	1209	1467
65	591	1109	1401
70	448	1011	1332
75	306	929	1298
80	171	871	1135
85	60	654	855
90	3	395	603

Coefficients of Utilization

rc	Effective floor cavity reflectance																	
	80%		70%		20%													
rw	70	50	30	10	70	50	30	10	50	30	10	50	30	10	50	30	10	0
0	111	111	111	111	106	106	106	106	98	98	98	90	90	90	83	83	83	79
1	98	92	87	82	93	88	83	79	81	77	74	74	71	68	68	66	63	60
2	88	78	71	64	83	75	68	62	69	63	58	63	58	54	58	54	50	47
3	79	68	59	52	75	65	57	50	59	53	47	54	49	44	50	45	41	38
4	72	59	50	43	68	57	48	42	52	45	39	48	42	37	44	39	35	32
5	66	52	43	36	62	50	42	35	46	39	33	43	36	31	39	34	30	27
6	61	47	38	31	57	45	37	30	42	34	29	38	32	27	35	30	26	23
7	56	42	33	27	53	41	32	26	38	30	25	35	28	24	32	27	22	20
8	52	38	30	24	49	37	29	23	34	27	22	32	26	21	29	24	20	18
9	48	35	27	21	46	34	26	21	31	25	20	29	23	19	27	22	18	16
10	45	32	24	19	43	31	24	19	29	22	18	27	21	17	25	20	16	14

Coefficients of Utilization

rc	Effective floor cavity reflectance																	
	80%		70%		20%													
rw	70	50	30	10	70	50	30	10	50	30	10	50	30	10	50	30	10	0
0	112	112	112	112	107	107	107	107	99	99	99	91	91	91	84	84	84	81
1	99	93	88	83	94	89	84	80	82	78	74	75	72	69	69	67	64	61
2	89	79	71	65	84	76	69	63	70	64	59	64	59	55	58	55	51	48
3	80	68	59	52	76	65	57	51	60	53	48	55	49	45	51	46	42	39
4	73	60	50	43	69	57	49	42	53	45	40	48	42	37	44	39	35	32
5	66	53	43	36	63	51	42	36	47	39	34	43	37	32	40	34	30	27
6	61	47	38	31	58	45	37	31	42	35	29	39	32	27	36	30	26	23
7	56	43	34	27	54	41	33	27	38	31	25	35	29	24	32	27	23	20
8	52	39	30	24	50	37	29	23	35	27	22	32	26	21	30	24	20	18
9	49	35	27	21	47	34	26	21	32	25	20	29	23	19	27	22	18	16
10	46	32	24	19	44	31	24	19	29	23	18	27	21	17	25	20	16	14

Zonal Lumen Summary

Zone	Lumens	%Lamp	%Fixture
0-30	905	15.5	16.1
0-40	1360	26.1	27.1
0-60	2634	50.6	52.5
0-90	4129	79.4	82.3
90-180	888	17.1	17.7
0-180	5016	96.5	100.0

Typical VCP Percentages

Room Size (Ft.)	Height Along		Height Across	
	8.5'	10.0'	8.5'	10.0'
20 x 20	28	38	16	25
30 x 30	18	25	8	13
30 x 60	15	20	3	5
60 x 30	15	20	10	15
60 x 60	11	14	4	6

Zonal Lumen Summary

Zone	Lumens	%Lamp	%Fixture
0-30	1376	15.6	16.1
0-40	2326	26.4	27.2
0-60	4516	51.3	52.7
0-90	7118	80.9	83.1
90-180	1448	16.4	16.9
0-180	8565	97.3	100.0

Typical VCP Percentages

Room Size (Ft.)	Height Along		Height Across	
	8.5'	10.0'	8.5'	10.0'
20 x 20	16	24	8	14
30 x 30	10	14	4	7
30 x 60	8	10	1	2
60 x 30	8	11	5	8
60 x 60	5	8	2	3

ORDERING INFORMATION

SAMPLE NUMBER: SSF-224T5-UNV-EBT1-U

<p>Tandem Blank=2' or 4' Length 8T=8' Length</p>	<p>Number of Lamps (Not Included) 1=1 Lamp 2=2 Lamps 3=3 Lamps⁽⁴⁾</p>	<p>Voltage⁽¹⁾ 347V=347 Volt UNV=Universal Voltage 120-277</p>
<p>Series SSF=Commercial Standard Striplite</p>	<p>Wattage 14T5=14W T5 (24") 24T5=24W T5HO (24") 28T5=28W T5 (48") 54T5=54W T5HO (48")</p>	<p>Options⁽¹⁾ GL=Single Element Fuse GM=Double Element Fuse EL5=Emergency Installed EL5HO=Emergency Installed for T5HO</p>

<p>Ballast Type⁽¹⁾ EBT No. of Ballast 1 or 2</p>	<p>=T5 or T5HO Linear Electronic Program Rapid Start Total Harmonic Distortion < 10%</p>	<p>Options 6-3/18 SJT-C&P-515P= Cord & Plug (120V) (15 AMP)⁽³⁾ 6-3/18 SJT-C&P-L715P=Cord & Plug (277V) (15 AMP)⁽³⁾ PI/CPI=Plug-In Option⁽³⁾ TILW=Tandem In-Line Wiring Option (Consult TILW Option Catalog Page)⁽²⁾</p>
<p>Ballast Factor/Type (For 28W T5 Lamp Only) N=Normal Light Output .95 BF H=High Light Output 1.15 BF⁽³⁾ NDIM=Normal .95-1.0 BF Step Dimming⁽³⁾ HDIM=High 1.15 BF Step Dimming⁽³⁾⁽⁵⁾</p>		<p>Packaging U=Unit Pack 4B=4 Bulk Packing</p>

NOTES: ⁽¹⁾Products also available in non-US voltages and frequencies for international markets. ⁽²⁾For SilverLining reflector add SS in Catalog Number, Example: SSF-ASY-SS-4T5. ⁽³⁾Socket brackets left uninstalled. Consult your Cooper Lighting Representative for availability and ordering information. ⁽⁴⁾Available in 28T5 and 54T5. ⁽⁵⁾Step dimming ballast available for 28T5, 14T5 lamps only.

Specifications & dimensions subject to change without notice. Consult your Eaton Representative for availability and ordering information.

SHIPPING DATA

Catalog No.	Wt.
SSF-114T5	7 lbs.
SSF-124T5	7 lbs.
SSF-128T5	7 lbs.
SSF-154T5	7 lbs.
SSF-214T5	9 lbs.
SSF-224T5	9 lbs.
SSF-228T5	9 lbs.
SSF-254T5	9 lbs.
SSF-328T5	11 lbs.
SSF-354T5	11 lbs.
8TSSF-228T5	18 lbs.

DESCRIPTION

The SSF Series is a functional and multi-purpose standard strip family that incorporates premium performance and construction durability. Designed with our easy-to-use Flip-Up socket design, the SSF significantly reduces installation time. The performance and application versatility of this series can be increased by incorporating symmetrical or asymmetrical reflectors. The SSF Series can be installed using various mounting methods and numerous options and accessories are available.

Catalog #		Type
Project		
Comments		Date
Prepared by		

SPECIFICATION FEATURES

Construction

Channel die formed cold rolled steel with numerous KOs for ease of installation. Groove for Tong Hanger. End plate quickly converts to snap-in channel connector for continuous row alignment. Lamp holder bracket flips in place. Channel/wireway cover secured with quarter-turn fasteners.

Channel/Wireway Cover

Die formed heavy gauge steel. Tight fit for ease of maintenance. Easily removed without use of tools. Optional reflector available

incorporating silver technology enhancements. (Silver Lining) Consult Pre Sales Technical Support.

Electrical*

Ballasts are CBM/ETL Class "P" and are positively secured by mounting bolts. Rotor Lock lampholders. UL/CUL listed. Suitable for damp locations.

Finish

Multistage iron phosphate pretreatment ensures maximum bonding and rust inhibitor. Lighting

upgrade, baked white enamel finish. Prepainted material is standard, PAF optional.

Application

The SSF Series can be the illumination solution in commercial, industrial, retail and residential applications. Fixtures can be used in storage/utility areas, coves, display cases, shops, task and general area lighting.



SSF
 114T5
 124T5
 128T5
 154T5
 214T5
 224T5
 228T5
 254T5
 328T5
 354T5

2' OR 4' STRIP
1, 2 OR 3 T5 OR T5HO LAMPS

Standard Striplite

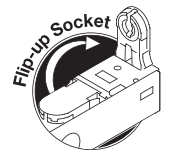

LAMP CONFIGURATIONS

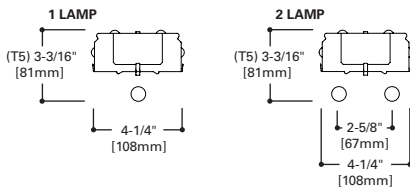

MOUNTING DATA

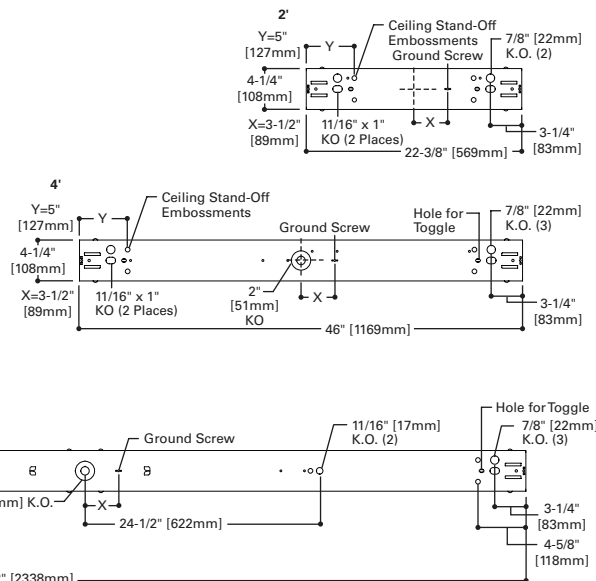

ENERGY DATA

Input Watts:
Electronic Ballast & Standard Lamps
 114 (19), 124 (25)
 128 (34), 154 (54)
 214 (38), 224 (52)
 228 (68), 254 (106)
 328 (97), 354 (182)

*Reference the lamp/ballast data in the Technical Section for specific lamp/ballast requirements.

LAMPS CONTAIN MERCURY. DISPOSE ACCORDING TO LOCAL, STATE OR FEDERAL LAWS

LINEAR DISCONNECT

Safe and convenient means of disconnecting power.



PHOTOMETRICS

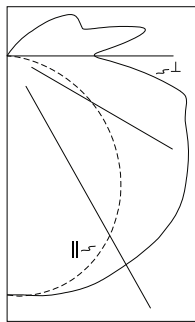

SSF-228T5-UNV-EBT1
Electronic Ballast
F28T5/835 Lamps
2600 Lumens
Spacing criterion:
(||) 1.3 x mounting
height, (⊥) 1.5 x
mounting height
Efficiency 96.5%
Test Report: 122P106
LER = FS
Yearly Cost of 1000
lumens, 3000 hrs at
.08 KWH = \$

Candlepower

Angle	Along	45°	Across ⊥
0	973	973	973
5	979	979	978
10	972	982	990
15	955	977	994
20	926	964	995
25	887	945	987
30	840	920	978
35	783	887	971
40	720	853	964
45	650	821	950
50	574	787	927
55	496	749	890
60	414	699	852
65	330	639	812
70	244	586	772
75	161	535	756
80	87	506	670
85	29	373	494
90	1	223	345

Coefficients of Utilization

rc	Effective floor cavity reflectance						20%												
	80%		70%		50%		30%		10%		0%								
rw	70	50	30	10	70	50	30	10	50	30	10	50	30	10	50	30	10	0	
RCR																			
0	111	111	111	111	106	106	106	106	98	98	98	90	90	90	83	83	83	79	
1	98	92	87	82	93	88	83	79	81	77	74	74	71	68	68	66	63	60	
2	88	78	71	64	83	75	68	62	69	63	58	63	58	54	58	54	50	47	
3	79	68	59	52	75	65	57	50	59	53	47	54	49	44	50	45	41	38	
4	72	59	50	43	68	57	48	42	52	45	39	48	42	37	44	39	35	32	
5	66	52	43	36	62	50	42	35	46	39	33	43	36	31	39	34	30	27	
6	61	47	38	31	57	45	37	30	42	34	29	38	32	27	35	30	26	23	
7	56	42	33	27	53	41	32	26	38	30	25	35	28	24	32	27	22	20	
8	52	38	30	24	49	37	29	23	34	27	22	32	26	21	29	24	20	18	
9	48	35	27	21	46	34	26	21	31	25	20	29	23	19	27	22	18	16	
10	45	32	24	19	43	31	24	19	29	22	18	27	21	17	25	20	16	14	

Zonal Lumen Summary

Zone	Lumens	%Lamp	%Fixture
0-30	905	15.5	16.1
0-40	1360	26.1	27.1
0-60	2634	50.6	52.5
0-90	4129	79.4	82.3
90-180	888	17.1	17.7
0-180	5016	96.5	100.0

Typical VCP Percentages

Room Size (Ft.)	Height Along		Height Across	
	8.5'	10.0'	8.5'	10.0'
20 x 20	28	38	16	25
30 x 30	18	25	8	13
30 x 60	15	20	3	5
60 x 30	15	20	10	15
60 x 60	11	14	4	6

ORDERING INFORMATION

SAMPLE NUMBER: SSF-224T5-UNV-EBT1-U

Tandem Blank=2' or 4' Length 8T=8' Length	Number of Lamps (Not Included) 1=1 Lamp 2=2 Lamps 3=3 Lamps ⁽⁴⁾	Voltage ⁽¹⁾ 347V=347 Volt UNV=Universal Voltage 120-277
Series SSF=Commercial Standard Striplite	Wattage 14T5=14W T5 (24") 24T5=24W T5HO (24") 28T5=28W T5 (48") 54T5=54W T5HO (48")	Options ⁽¹⁾ GL=Single Element Fuse GM=Double Element Fuse EL5=Emergency Installed EL5HO=Emergency Installed for T5HO

Ballast Type ⁽¹⁾ EBT	=T5 or T5HO Linear Electronic Program Rapid Start Total Harmonic Distortion < 10%	Options 6-3/18 SJT-C&P-515P= Cord & Plug (120V) (15 AMP) ⁽³⁾ 6-3/18 SJT-C&P-L715P=Cord & Plug (277V) (15 AMP) ⁽³⁾ PI/CPI=Plug-In Option ⁽³⁾ TILW=Tandem In-Line Wiring Option (Consult TILW Option Catalog Page) ⁽²⁾
No. of Ballast 1 or 2		Packaging U=Unit Pack 4B=4 Bulk Packing
Ballast Factor/Type (For 28W T5 Lamp Only) N=Normal Light Output .95 BF H=High Light Output 1.15 BF ⁽⁵⁾ NDIM=Normal .95-1.0 BF Step Dimming ⁽⁵⁾ HDIM=High 1.15 BF Step Dimming ⁽⁵⁾		

NOTES: ⁽¹⁾Products also available in non-US voltages and frequencies for international markets. ⁽²⁾For SilverLining reflector add SS in Catalog Number, Example: SSF-ASY-SS-4T5. ⁽³⁾Socket brackets left uninstalled. Consult your Cooper Lighting Representative for availability and ordering information. ⁽⁴⁾Available in 28T5 and 54T5. ⁽⁵⁾Step dimming ballast available for 28T5, 14T5 lamps only.

Specifications & dimensions subject to change without notice. Consult your Eaton Representative for availability and ordering information.

SHIPPING DATA

Catalog No.	Wt.
SSF-114T5	7 lbs.
SSF-124T5	7 lbs.
SSF-128T5	7 lbs.
SSF-154T5	7 lbs.
SSF-214T5	9 lbs.
SSF-224T5	9 lbs.
SSF-228T5	9 lbs.
SSF-254T5	9 lbs.
SSF-328T5	11 lbs.
SSF-354T5	11 lbs.
8TSSF-228T5	18 lbs.