

Ariadni 250 W C•L Dimmer

Dimmer for CFL, LED, Halogen, and Incandescent dimmable bulbs.

Features

- On/off toggle switch with a captive linear-slide dimmer for a traditional wallplate opening
- HED Technology: Advanced Lutron dimming circuitry designed for compatibility with most high efficacy light bulbs
- UL® Listed to control:
 - Dimmable compact fluorescent load (CFL) with integrated ballast
 - Dimmable LED with integrated driver
 - Lutron Hi-lume A-Series LTE LED Driver
 - Halogen
 - Incandescent
- Low-end adjustment to accommodate a wide range of bulbs
- 100% factory tested
- NEMA SSL-7A Type 2 Compliant

Application Requirements

- **When dimming CFLs or LEDs, only bulbs marked or rated as DIMMABLE may be used.**
- For a list of compatible DIMMABLE CFLs and LEDs please visit www.lutron.com/dimcflled. For questions call 1.844.LUTRON1.
- Some DIMMABLE CFLs and LEDs require a minimum number of bulbs for proper operation. For details and a list of bulbs, please visit www.lutron.com/dimcflled.

Model Numbers

AYCL-253P-XX^{1, 2} Single pole/3-way³
 AYCL-253PH-WH-C⁴ Single pole/3-way³

¹ "XX" in the model number represents color/finish code; see "Colors and Finishes" chart on Page 3.
² For clamshell packaging, add "H" after "253P". Clamshell packaged product available in IV, LA, and WH.
³ For 3-way and 4-way switching, use mechanical switches.
⁴ Clamshell packaged product for Canada. Available in WH only.



* Wallplate sold separately

Job Name:	Model Numbers:
Job Number:	

Specifications

Regulatory Approvals

- UL® Listed to US and Canadian safety requirements
UL1472 / CSA C22.2 184.1
- NEMA SSL-7A Type 2

Power and Ratings

- 120 V~ 60 Hz
- 250 W dimmable CFL/LED
- or**
- 600 W Incandescent/Halogen
- or**
- Mixed bulb type per **Multigang and Mixed Bulb Type Ratings** table
- or**
- 350 W Lutron Hi-lume A-Series LTE LED Driver (maximum 8 drivers)

Environment

- For indoor use only.
- Ambient operating temperature: 32 °F to 104 °F (0 °C to 40 °C), 0% - 90% humidity

Performance

- Power failure memory: should power be interrupted, the control will return to its previously set level prior to the interruption when power is restored.
- Tested to withstand electrostatic discharge without damage or memory loss, in accordance with IEC 61000-4-2.
- Precise color matching
- Mechanical air-gap switch to disconnect load power

Warranty

- 1 Year Limited Warranty
For additional Warranty information, please visit www.lutron.com/TechnicalDocumentLibrary/369-119_Wallbox_Warranty.pdf

<p>Job Name:</p> <p>Job Number:</p>	<p>Model Numbers:</p>
--	------------------------------

Dimensions

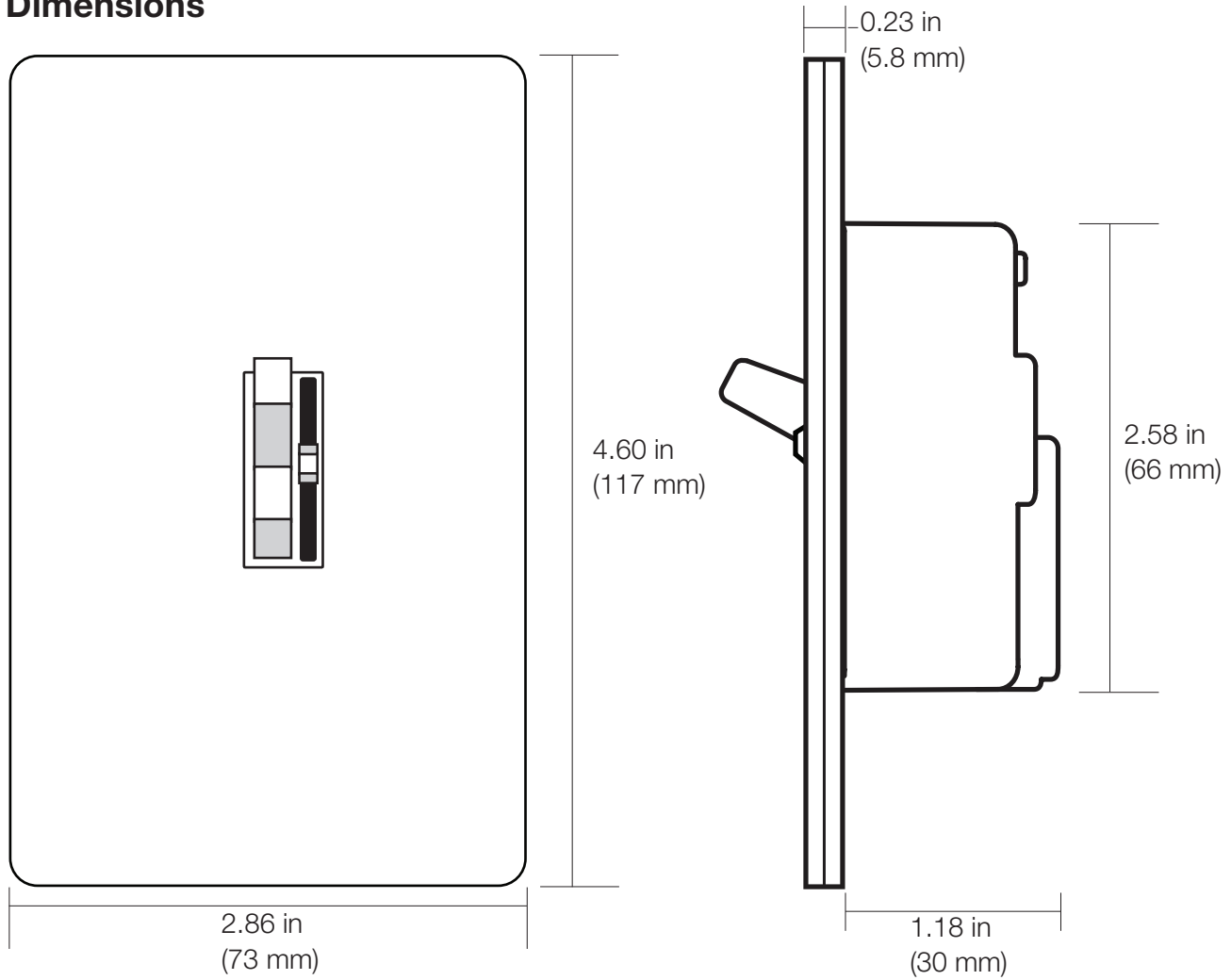

Colors and Finishes

Gloss Finishes

Add color/finish code to model #

Example: AYCL-253P-WH

- WH White
- IV Ivory
- AL Almond
- LA Light Almond
- BR Brown
- BL Black

Job Name:	Model Numbers:
Job Number:	

Multigang and Mixed-Bulb-Type Ratings



When installing more than one Dimmer in the same wallbox, it may be necessary to remove some side sections prior to wiring (**see diagram**). Removal of Dimmer side sections may reduce maximum wattage, as shown in the chart below.

Mixing bulb types (**using a combination of CFL/LED, and Incandescent/Halogen bulbs**) will also affect the maximum ratings, as shown in the chart below.

Note: Lutron Hi-lume A-Series LTE LED loads cannot be mixed with other loads.

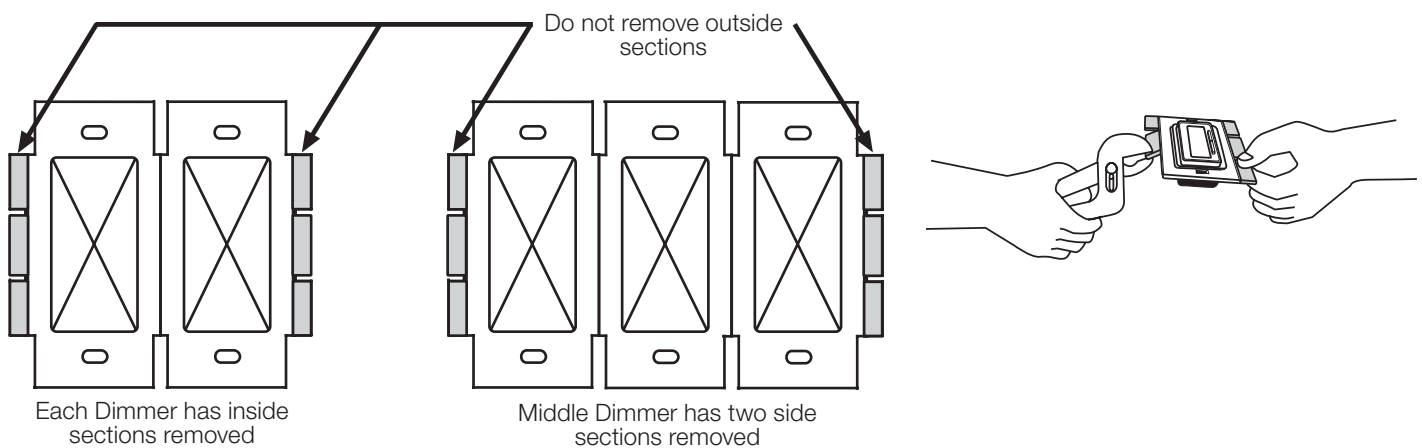
*EXAMPLE: If one set of side sections is removed and you have eight 9 W LED bulbs installed (Total LED Wattage = 72 W), you may add up to 300 W of incandescent or halogen lighting.

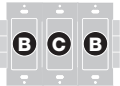

Total CFL/LED Wattage Installed (Wattage per bulb x # of bulbs)	Maximum Allowable Incandescent/Halogen Wattage		
	  		
	A No sides removed	B 1 side removed	C 2 sides removed
0 W	+ 600 W	500 W	400 W
1 W – 40 W	+ 500 W	400 W	300 W
41 W – 80 W	+ 400 W	300 W	200 W
81 W – 120 W	+ 300 W	200 W	100 W
121 W – 160 W	+ 200 W	100 W	50 W
161 W – 200 W	+ 100 W	50 W	0 W
201 W – 250 W	+ 0 W	0 W	0 W

Note: There is no wattage reduction when controlling only LED or CFL

Job Name:	Model Numbers:
Job Number:	

Operation (View with wallplate removed)

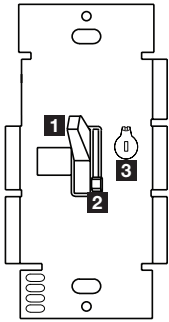

1 Switch
Turns lights ON and OFF.

2 Slider
Controls light level.

+ ↑ **Up**
Increases light level

- ↓ **Down**
Decreases light level

IMPORTANT: Set slider to bottom before adjusting dimming range.

Lever-type Adjustment Dial

3 Adjustment lever
Sets low end dimming limit.

Right (clockwise)
Increases brightness

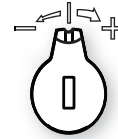

Left (counter-clockwise)
Decreases brightness

Lutron, Lutron, Ariadni, C•L, and Hi-lume are trademarks of Lutron Electronics Co., Inc., registered in the U.S. and other countries. HED is a trademark of Lutron Electronics Co., Inc.

<p>Job Name:</p> <p>Job Number:</p>	<p>Model Numbers:</p>
--	-----------------------

Wiring Diagrams

Single-Pole Wiring

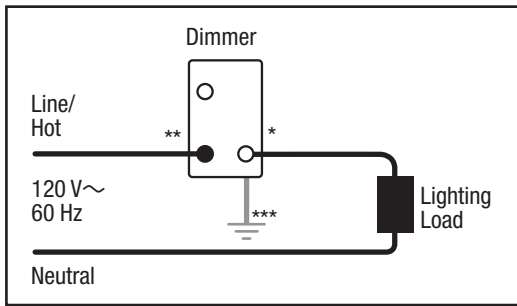

3-Way Wiring

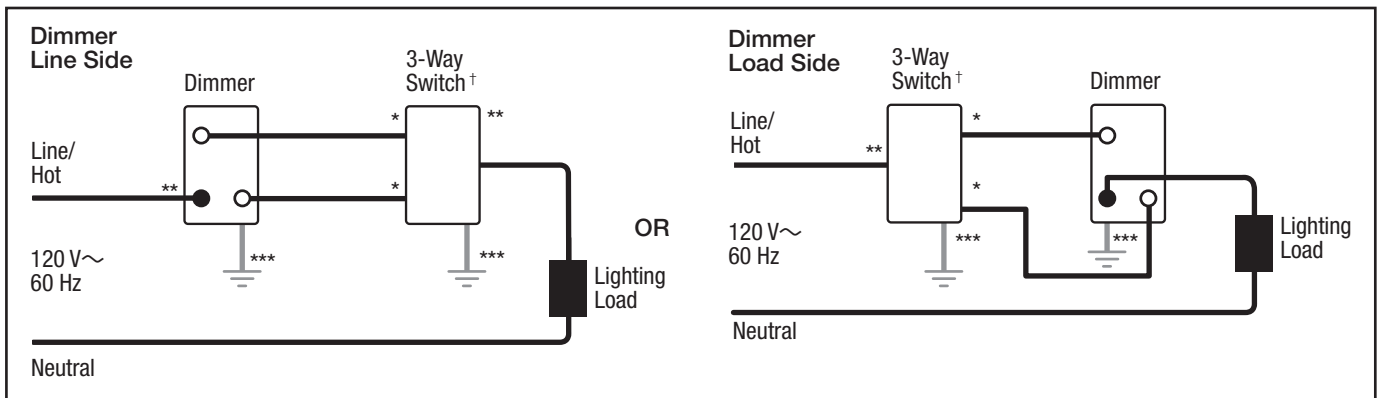

4-Way Wiring

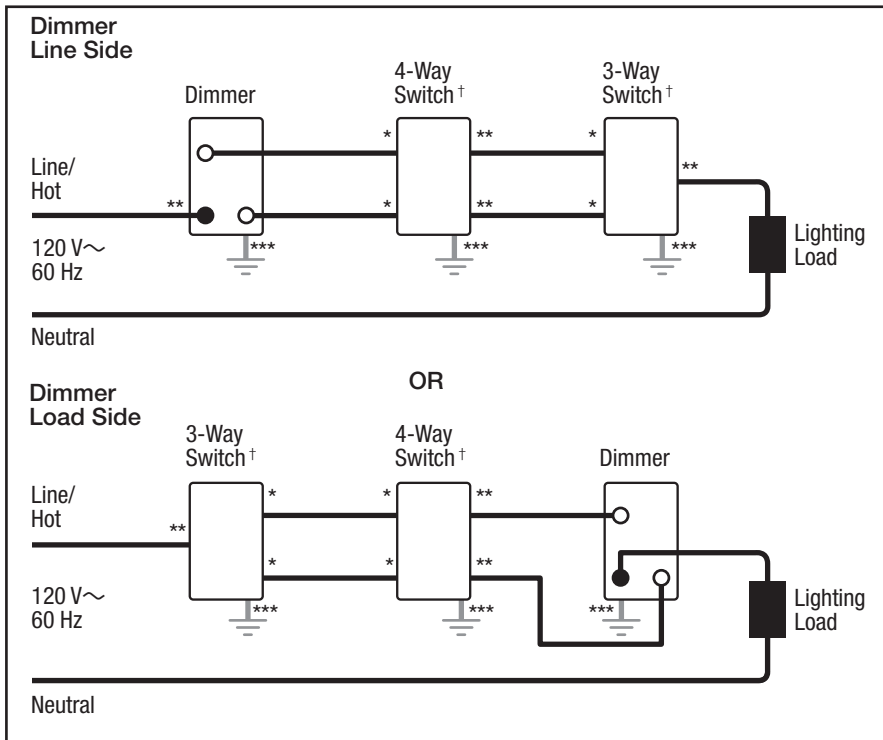

- * Brass/Gold screw terminal
- ** Copper/Black screw terminal
- *** Green screw terminal
- † Please refer to switch instruction sheet for proper wiring.

Note for 4-Way Wiring:
 Dimmer must be installed Line Side or Load Side. It cannot be installed in the 4-way location.

Job Name:	Model Numbers:
Job Number:	

Ariadni 250 W C•L Dimmer

Dimmer for CFL, LED, Halogen, and Incandescent dimmable bulbs.

Features

- On/off toggle switch with a captive linear-slide dimmer for a traditional wallplate opening
- HED Technology: Advanced Lutron dimming circuitry designed for compatibility with most high efficacy light bulbs
- UL[®] Listed to control:
 - Dimmable compact fluorescent load (CFL) with integrated ballast
 - Dimmable LED with integrated driver
 - Lutron Hi-lume A-Series LTE LED Driver
 - Halogen
 - Incandescent
- Low-end adjustment to accommodate a wide range of bulbs
- 100% factory tested
- NEMA SSL-7A Type 2 Compliant

Application Requirements

- **When dimming CFLs or LEDs, only bulbs marked or rated as DIMMABLE may be used.**
- For a list of compatible DIMMABLE CFLs and LEDs please visit www.lutron.com/dimcflled. For questions call 1.844.LUTRON1.
- Some DIMMABLE CFLs and LEDs require a minimum number of bulbs for proper operation. For details and a list of bulbs, please visit www.lutron.com/dimcflled.

Model Numbers

AYCL-253P-XX^{1, 2} Single pole/3-way³
 AYCL-253PH-WH-C⁴ Single pole/3-way³

¹ "XX" in the model number represents color/finish code; see "Colors and Finishes" chart on Page 3.
² For clamshell packaging, add "H" after "253P". Clamshell packaged product available in IV, LA, and WH.
³ For 3-way and 4-way switching, use mechanical switches.
⁴ Clamshell packaged product for Canada. Available in WH only.



* Wallplate sold separately

Job Name:	Model Numbers:
Job Number:	

Specifications

Regulatory Approvals

- UL® Listed to US and Canadian safety requirements
UL1472 / CSA C22.2 184.1
- NEMA SSL-7A Type 2

Power and Ratings

- 120 V~ 60 Hz
- 250 W dimmable CFL/LED
- or**
- 600 W Incandescent/Halogen
- or**
- Mixed bulb type per **Multigang and Mixed Bulb Type Ratings** table
- or**
- 350 W Lutron Hi-lume A-Series LTE LED Driver (maximum 8 drivers)

Environment

- For indoor use only.
- Ambient operating temperature: 32 °F to 104 °F (0 °C to 40 °C), 0% - 90% humidity

Performance

- Power failure memory: should power be interrupted, the control will return to its previously set level prior to the interruption when power is restored.
- Tested to withstand electrostatic discharge without damage or memory loss, in accordance with IEC 61000-4-2.
- Precise color matching
- Mechanical air-gap switch to disconnect load power

Warranty

- 1 Year Limited Warranty
- For additional Warranty information, please visit www.lutron.com/TechnicalDocumentLibrary/369-119_Wallbox_Warranty.pdf

<p>Job Name:</p> <p>Job Number:</p>	<p>Model Numbers:</p>
--	------------------------------

Dimensions

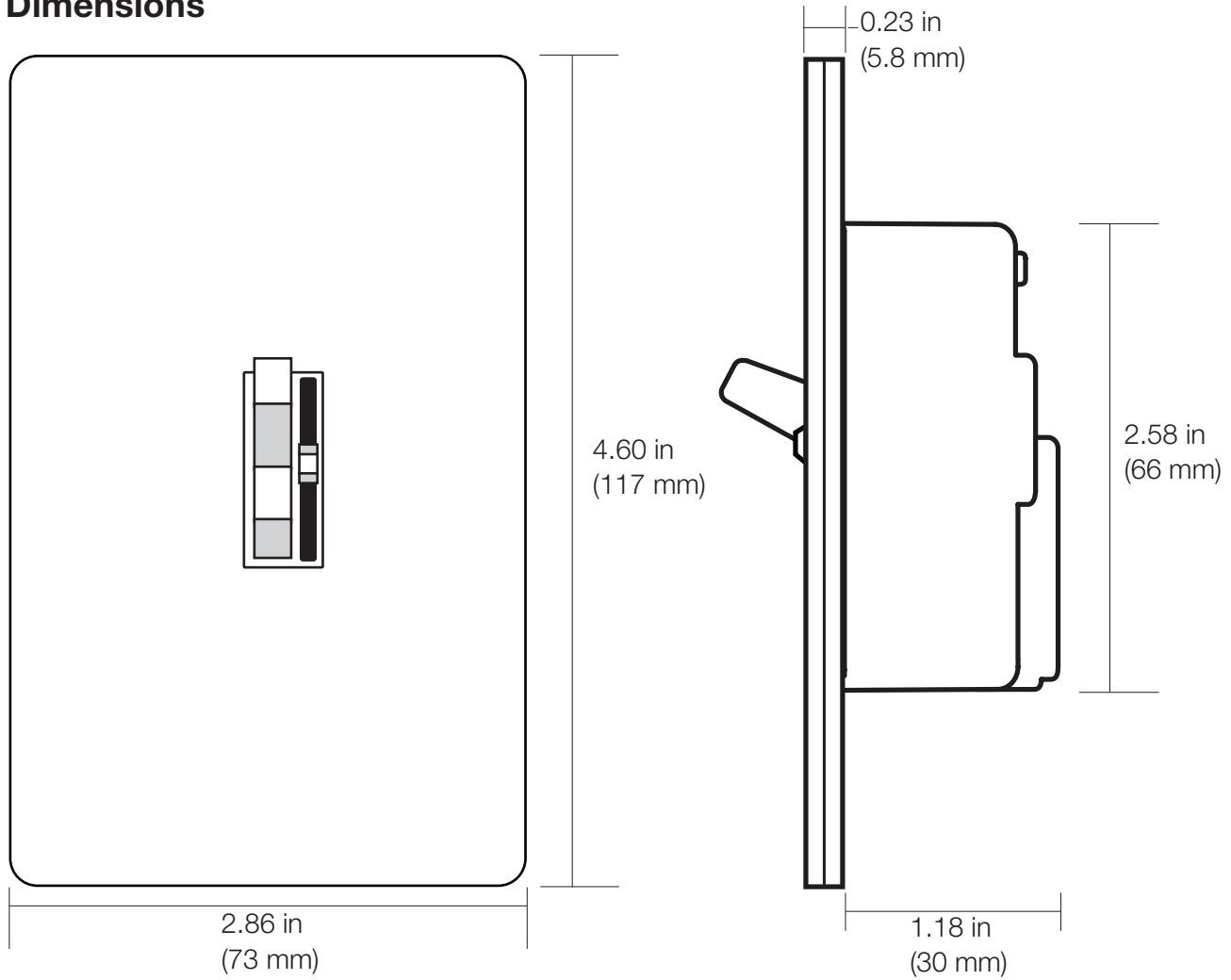

Colors and Finishes

Gloss Finishes

Add color/finish code to model #

Example: AYCL-253P-WH

- WH White
- IV Ivory
- AL Almond
- LA Light Almond
- BR Brown
- BL Black

Job Name:	Model Numbers:
Job Number:	

Multigang and Mixed-Bulb-Type Ratings



When installing more than one Dimmer in the same wallbox, it may be necessary to remove some side sections prior to wiring (**see diagram**). Removal of Dimmer side sections may reduce maximum wattage, as shown in the chart below.

Mixing bulb types (**using a combination of CFL/LED, and Incandescent/Halogen bulbs**) will also affect the maximum ratings, as shown in the chart below.

Note: Lutron Hi-lume A-Series LTE LED loads cannot be mixed with other loads.

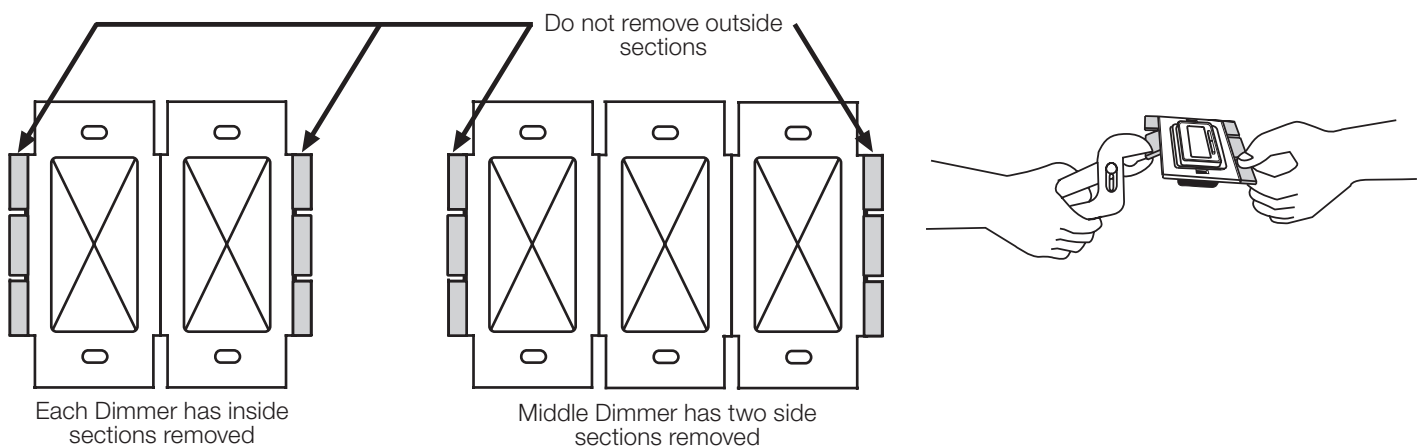
*EXAMPLE: If one set of side sections is removed and you have eight 9 W LED bulbs installed (Total LED Wattage = 72 W), you may add up to 300 W of incandescent or halogen lighting.

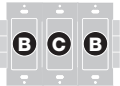

Total CFL/LED Wattage Installed (Wattage per bulb x # of bulbs)	Maximum Allowable Incandescent/Halogen Wattage		
	  		
	A No sides removed	B 1 side removed	C 2 sides removed
0 W	+ 600 W	500 W	400 W
1 W – 40 W	+ 500 W	400 W	300 W
41 W – 80 W	+ 400 W	300 W	200 W
81 W – 120 W	+ 300 W	200 W	100 W
121 W – 160 W	+ 200 W	100 W	50 W
161 W – 200 W	+ 100 W	50 W	0 W
201 W – 250 W	+ 0 W	0 W	0 W

Note: There is no wattage reduction when controlling only LED or CFL

Job Name:	Model Numbers:
Job Number:	

Operation (View with wallplate removed)

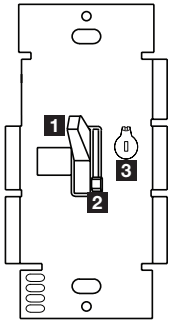

1 Switch
Turns lights ON and OFF.

2 Slider
Controls light level.

+ ↑ **Up**
Increases light level

- ↓ **Down**
Decreases light level

IMPORTANT: Set slider to bottom before adjusting dimming range.

Lever-type Adjustment Dial

3 Adjustment lever
Sets low end dimming limit.

Right (clockwise)
Increases brightness



Left (counter-clockwise)
Decreases brightness

Lutron, Lutron, Ariadni, C•L, and Hi-lume are trademarks of Lutron Electronics Co., Inc., registered in the U.S. and other countries. HED is a trademark of Lutron Electronics Co., Inc.

<p>Job Name:</p> <p>Job Number:</p>	<p>Model Numbers:</p>
--	-----------------------

Wiring Diagrams

Single-Pole Wiring

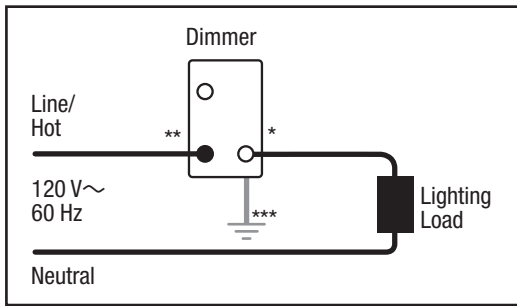

3-Way Wiring

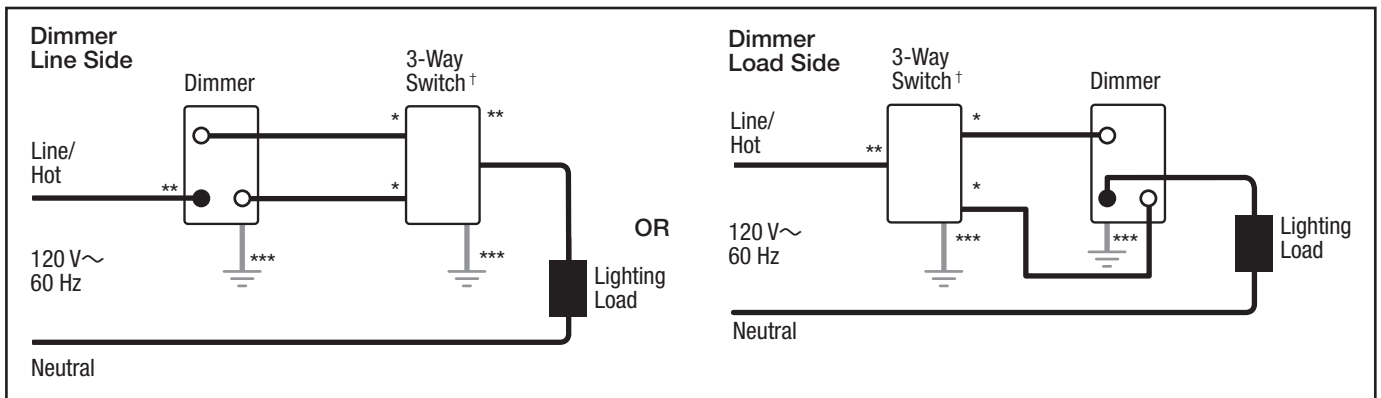

4-Way Wiring

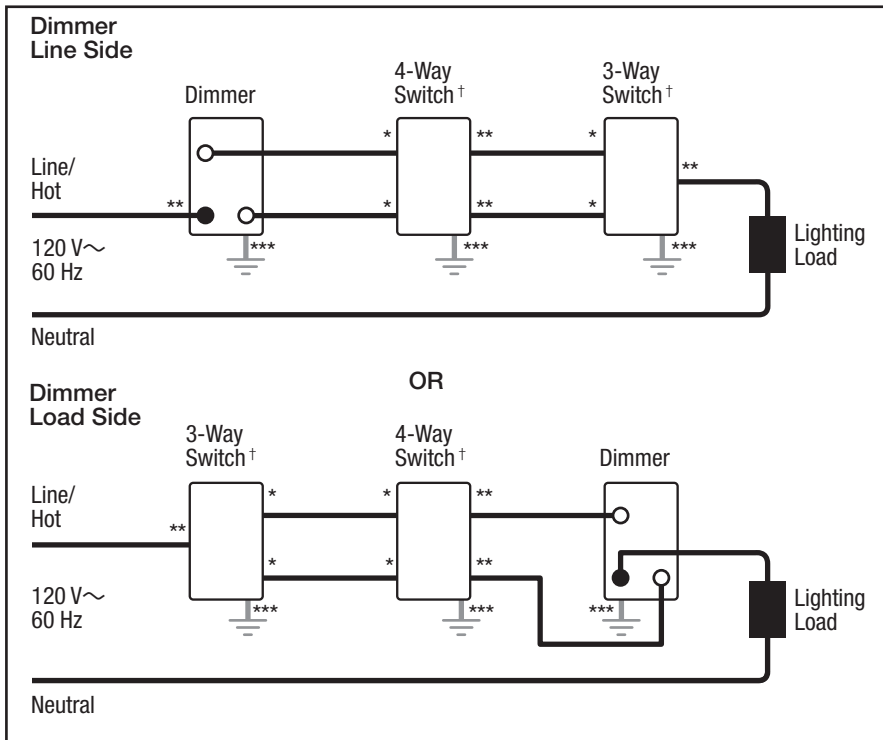

- * Brass/Gold screw terminal
- ** Copper/Black screw terminal
- *** Green screw terminal
- † Please refer to switch instruction sheet for proper wiring.

Note for 4-Way Wiring:
 Dimmer must be installed Line Side or Load Side. It cannot be installed in the 4-way location.

Job Name:	Model Numbers:
Job Number:	