

# Aluminum Channel & Closure Strips

## B11AL

- Thickness: .105 (2.6 mm)
- Standard Length: 10' (3.05 m) and 20' (6.09 m)
- Material: Aluminum
- Weight: 1.06 Lbs./Ft. (1.58 kg/m)

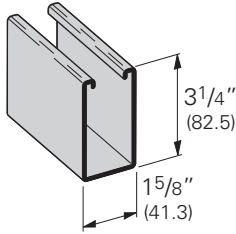

## B12AL

- Thickness: .105 (2.6 mm)
- Standard Length: 10' (3.05 m) and 20' (6.09 m)
- Material: Aluminum
- Weight: .86 Lbs./Ft. (1.28 kg/m)

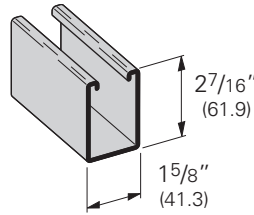

## B22AL

- Thickness: .105 (2.6 mm)
- Standard Length: 10' (3.05 m) and 20' (6.09 m)
- Material: Aluminum
- Weight: .66 Lbs./Ft. (0.98 kg/m)

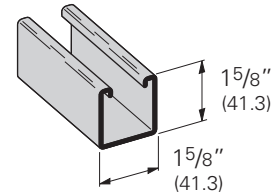

## B22AAL

- Thickness: .105 (2.6 mm)
- Standard Length: 10' (3.05 m) and 20' (6.09 m)
- Material: Aluminum
- Weight: 1.18 Lbs./Ft. (1.75 kg/m)

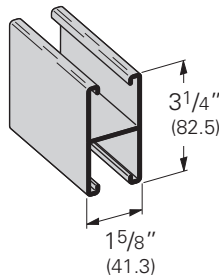

## B24AL

- Thickness: .080 (2.0 mm)
- Standard Length: 10' (3.05 m) and 20' (6.09 m)
- Material: Aluminum
- Weight: .52 Lbs./Ft. (0.77 kg/m)

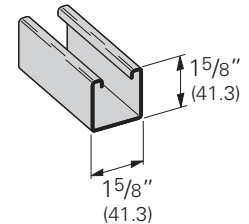

## B54AL

- Thickness: .080 (2.0 mm)
- Standard Length: 10' (3.05 m) and 20' (6.09 m)
- Material: Aluminum
- Weight: .37 Lbs./Ft. (0.55 kg/m)

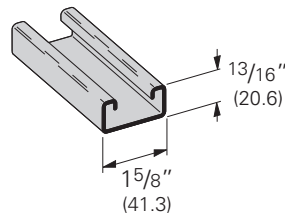

## B54AAL

- Thickness: .080 (2.0 mm)
- Standard Length: 10' (3.05 m) and 20' (6.09 m)
- Material: Aluminum
- Weight: .57 Lbs./Ft. (0.84 kg/m)

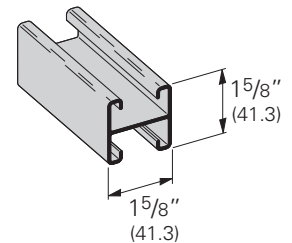

## B217AL Closure Strip

- Standard Length: 10' (304.8 cm)
- Material: Aluminum
- Weight: .15 Lbs./Ft. (0.23 kg/m)

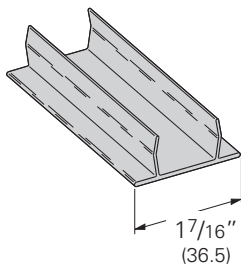

## B217P Plastic Closure Strip

- Standard Length: 10' (304.8 cm)
- Material: PVC
- Weight: .09 Lbs./Ft. (0.14 kg/m)

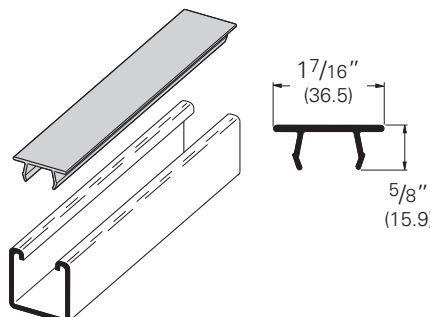

## B217FFAL Closure Strip

- Standard Length: 10' (304.8 cm)
- Material: Aluminum
- Weight: .16 Lbs./Ft. (0.24 kg/m)

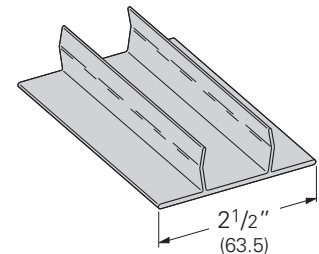

Reference page 177 for general fitting specifications. Other channel combinations available-see steel section for styles.