

Mini Channel & Fittings

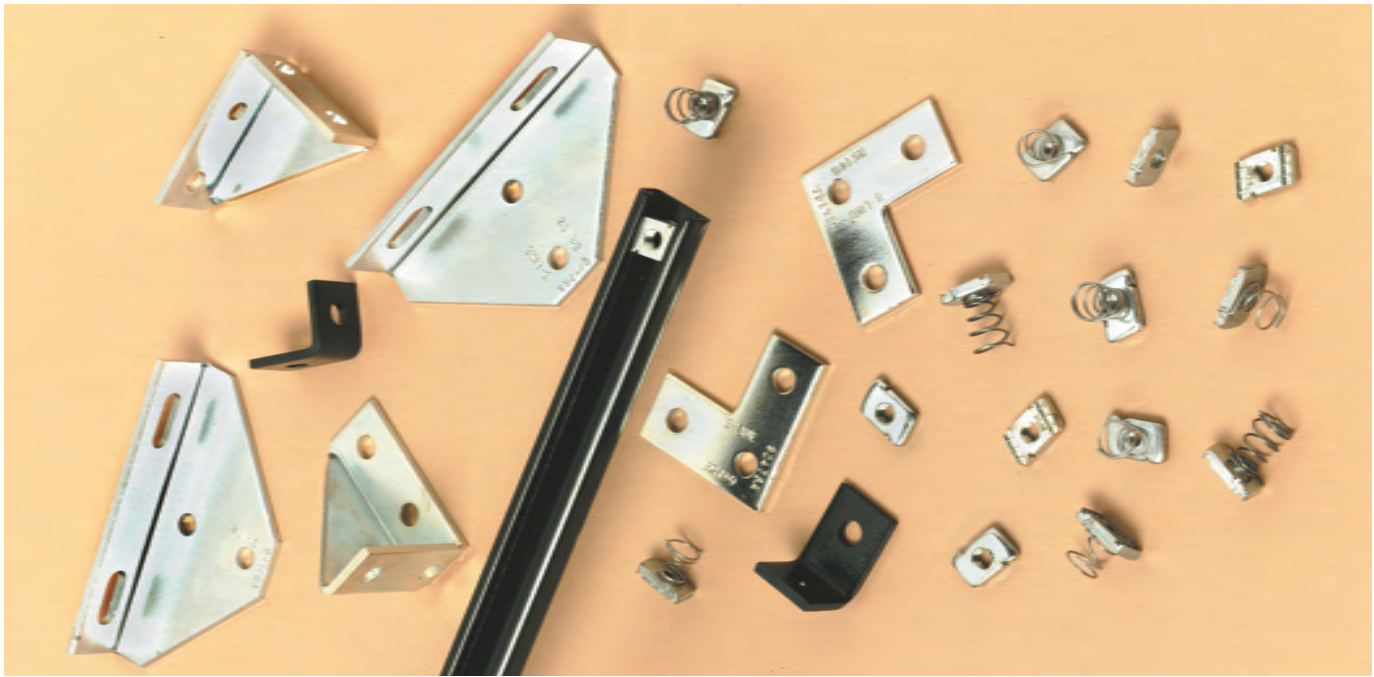

Our mini channels and fittings provide for an economical method of supporting light load requirements on a strut system.

Channel

Channels are cold formed on our modern rolling mills from 18 Ga. (1.2 mm) low carbon steel strips plain steel (ASTM A1008 33,000 PSI min. yield) and pre-galvanized steel strips, (ASTM A653 33,000 PSI min. yield). A continuous slot with inturred lips provides the ability to make attachments at any point. Channel combinations are made with new state of the art, high-tech welding equipment.

Lengths

Standard lengths are 10' (3.05 m) and 20' (6.09 m) for B62 series, and 10' (3.05 m) for B72 series. Custom lengths are available.

Fittings

Mini fittings are formed from hot rolled pickled and oiled strip or sheet steel (ASTM A1011, HSLAS, Grade 50, Class1). The following dimensions apply to all fittings except as noted on the drawings:

Hole Size – $9/32$ " (7.14 mm) Dia.

Hole Spacing – $13/32$ " (10.3 mm) from end and $1\ 1/16$ " (27.0 mm) on center.

Width – $13/16$ " (20.6 mm)

Thickness – $1/8$ " (3.2 mm)

Materials & Finishes*

*Unless otherwise noted.

Finish Code	Finish	Specification
PLN	Plain	ASTM A1011, HSLAS, Grade 50, Class 1
ZN	Electro-Plated Zinc	ASTM B633 SC3 Type II
GRN	DURA-GREEN™	
GLV	Pre-Galvanized	ASTM A653 33,000 PSI min. yield
HDG	Hot-Dipped Galvanized	ASTM A123

Metric

Metric dimensions are shown in parentheses. Unless noted, all metric dimensions are in millimeters.

B62 Channel

- Thickness: 18 Ga. (1.2 mm)
- Standard lengths: 10' (3.05 m) & 20' (6.09 m)
- Standard finishes: Plain, DURA GREEN™, Pre-Galvanized
- Weight: .42 Lbs./Ft. (.62 kg/m)

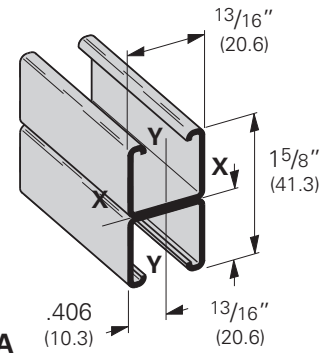
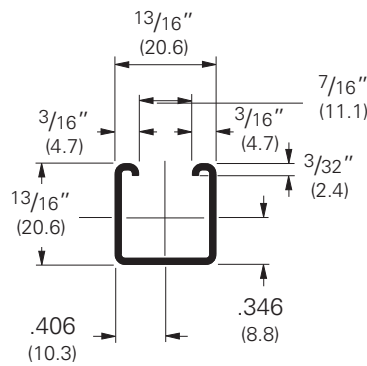
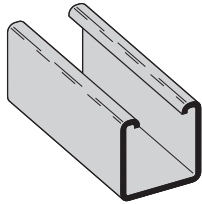

B62A
Wt. .84 Lbs./Ft. (1.25 kg/m)

Section Properties

Channel	Weight lbs./ft. kg/m	Areas of Section sq. in. cm ²	X - X Axis				Y - Y Axis			
			Moment of Inertia (I) in. ⁴ cm ⁴	Section Modulus (S) in. ³ cm ³	Radius of Gyration (r) in. cm	Moment of Inertia (I) in. ⁴ cm ⁴	Section Modulus (S) in. ³ cm ³	Radius of Gyration (r) in. cm		
B62	.420 (.62)	.123 (.80)	.0103 (.43)	.0221 (.36)	.289 (.73)	.0134 (.56)	.0330 (.54)	.330 (.84)		
B62A	.839 (1.25)	.247 (1.59)	.0500 (2.08)	.0616 (1.01)	.450 (1.14)	.0269 (1.12)	.0663 (1.09)	.330 (.84)		

Calculations of section properties are based on metal thicknesses as determined by the AISI Cold-Formed Steel Design Manual.

Beam Loading

Beam Span In. mm	Channel Style	Uniform Load and Deflection				Uniform Load @ Deflection =			
		Lbs. kN		In. mm		1/240 Span		1/360 Span	
12 (305)	B62	364 (1.62)	.027 (.68)	364 (1.62)	364 (1.62)				
	B62A	420* (1.87)	.006 (.15)	420* (1.87)	420* (1.87)				
24 (609)	B62	182 (0.81)	.109 (2.77)	167 (0.74)	111 (0.49)				
	B62A	420* (1.87)	.051 (1.29)	420* (1.87)	420* (1.87)				
36 (914)	B62	121 (0.54)	.245 (6.22)	74 (0.33)	50 (0.22)				
	B62A	341 (1.51)	.141 (3.58)	341 (1.51)	242 (1.07)				
48 (1219)	B62	91 (0.40)	.436 (11.07)	42 (0.18)	28 (0.12)				
	B62A	256 (1.14)	.250 (6.35)	204 (0.91)	136 (0.60)				
60 (1524)	B62	73 (0.32)	.681 (17.30)	27 (0.12)	18 (0.08)				
	B62A	205 (0.91)	.391 (9.93)	131 (0.58)	87 (0.39)				
72 (1829)	B62	61 (0.27)	.981 (24.92)	19 (0.08)	12 (0.05)				
	B62A	170 (0.75)	.563 (14.30)	91 (0.40)	61 (0.27)				

Based on simple beam condition using an allowable design stress of 25,000 psi (172 MPa) in accordance with MFMA, with adequate lateral bracing (see page 12 for further explanation). Actual yield point of cold rolled steel is 42,000 psi. To determine concentrated load capacity at mid span, multiply uniform load by 0.5 and corresponding deflection by 0.8. *Failure determined by weld shear.

Column Loading

Unbraced Height In. mm	Channel Style	Max. Column Loading K = .80				Max. Column Loading (Loaded @ C.G.)					
		Loaded @ C.G.		Loaded @ Slot Face		K = .65		K = 1.0		K = 1.2	
		Lbs. kN	Lbs. kN	Lbs. kN	Lbs. kN	Lbs. kN	Lbs. kN	Lbs. kN	Lbs. kN		
12 (305)	B62	2052 (9.13)	820 (3.65)	2161 (9.61)	1890 (8.41)	1715 (7.63)					
	B62A	4666 (20.75)	1449 (6.44)	4710 (20.95)	4593 (20.43)	4503 (20.03)					
24 (609)	B62	1350 (6.00)	645 (2.87)	1624 (7.22)	1020 (4.54)	818 (3.64)					
	B62A	4275 (19.01)	1367 (6.08)	4453 (19.81)	3982 (17.71)	3624 (16.12)					
36 (914)	B62	818 (3.64)	471 (2.09)	1053 (4.68)	633 (2.81)	515 (2.29)					
	B62A	3624 (16.12)	847 (3.77)	4023 (17.89)	2965 (13.19)	2179 (9.69)					
48 (1219)	B62	589 (2.62)	369 (1.64)	745 (3.31)	456 (2.03)	365** (1.62)					
	B62A	2713 (12.06)	504 (2.24)	3421 (15.21)	1765 (7.85)	1225 (5.45)					
60 (1524)	B62	456 (2.03)	300 (1.33)	579 (2.57)	347** (1.54)	271** (1.20)					
	B62A	1765 (7.85)	323 (1.44)	2647 (11.77)	1129 (5.02)	784** (3.49)					
72 (1829)	B62	365** (1.62)	248 (1.10)	470 (2.09)	271** (1.20)	-					
	B62A	1225 (5.45)	224 (0.99)	1856 (8.25)	784** (3.49)	545** (2.42)					

**Where the slenderness ratio $\frac{KL}{r}$ exceeds 200, and K = end fixity factor, L = actual length and r = radius of gyration.

Reference page 201 for general fitting specifications.

B72 Channel

- Thickness: 18 Ga. (1.2 mm)
- Standard lengths: 10' (3.05 m) & 20' (6.09 m)
- Standard finishes: Plain, DURA GREEN™, Pre-Galvanized
- Weight: .29 Lbs./Ft. (.43 kg/m)

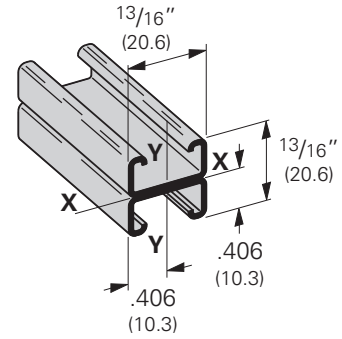
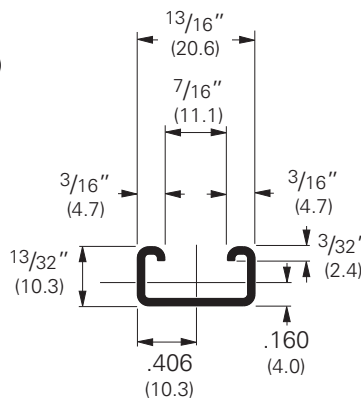
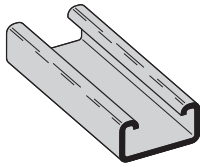

B72A
Wt. .58 Lbs./Ft. (.87 kg/m)

Section Properties

Channel	Weight lbs./ft. kg/m	Areas of Section sq. in. cm ²	X - X Axis			Y - Y Axis		
			Moment of Inertia (I) in. ⁴ cm ⁴	Section Modulus (S) in. ³ cm ³	Radius of Gyration (r) in. cm	Moment of Inertia (I) in. ⁴ cm ⁴	Section Modulus (S) in. ³ cm ³	Radius of Gyration (r) in. cm
B72	.287 (.43)	.084 (.54)	.0018 (.07)	.0073 (.12)	.146 (.37)	.0077 (.32)	.0190 (.31)	.302 (.77)
B72A	.574 (.85)	.169 (1.09)	.0078 (.32)	.0192 (.31)	.215 (.55)	.0155 (.65)	.0382 (.63)	.303 (.77)

Calculations of section properties are based on metal thicknesses as determined by the AISI Cold-Formed Steel Design Manual.

Beam Loading

Beam Span In. mm	Channel Style	Uniform Load and Deflection				Uniform Load @ Deflection =			
		Lbs. kN		In. mm		1/240 Span		1/360 Span	
12 (305)	B72 B72A	116 (0.51)	.051 (1.29)	113 (0.50)	75 (0.32)				
		210* (0.93)	.020 (.51)	210* (0.93)	210* (0.93)				
24 (609)	B72 B72A	58 (0.26)	.206 (5.23)	28 (0.12)	19 (0.08)				
		159 (0.71)	.125 (3.17)	127 (0.56)	85 (0.38)				
36 (914)	B72 B72A	39 (0.17)	.465 (11.81)	13 (0.06)	8 (0.03)				
		106 (0.45)	.281 (7.14)	57 (0.25)	38 (0.17)				
36 (1219)	B72 B72A	29 (0.13)	.827 (21.00)	7 (0.03)	5 (0.02)				
		80 (0.35)	.500 (12.70)	32 (0.14)	21 (0.09)				
60 (1524)	B72 B72A	23 (0.10)	1.292 (32.81)	5 (0.02)	3 (0.01)				
		64 (0.28)	.782 (19.86)	20 (0.09)	14 (0.06)				

Based on simple beam condition using an allowable design stress of 25,000 psi (172 MPa) in accordance with MFMA, with adequate lateral bracing (see page 12 for further explanation). Actual yield point of cold rolled steel is 42,000 psi. To determine concentrated load capacity at mid span, multiply uniform load by 0.5 and corresponding deflection by 0.8. *Failure determined by weld shear.

Column Loading

Unbraced Height In. mm	Channel Style	Max. Column Loading K = .80		Max. Column Loading (Loaded @ C.G.)							
		Loaded @ C.G.		Loaded @ Slot Face		K = .65		K = 1.0		K = 1.2	
		Lbs. kN	Lbs. kN	Lbs. kN	Lbs. kN	Lbs. kN	Lbs. kN	Lbs. kN	Lbs. kN		
12 (305)	B72 B72A	1598 (7.11)	539 (2.40)	1712 (7.61)	1410 (6.27)	1181 (5.25)					
		3600 (16.01)	986 (4.38)	3700 (16.46)	3433 (15.27)	3229 (14.36)					
24 (609)	B72 B72A	701 (3.12)	320 (1.42)	1050 (4.67)	450 (2.00)	313** (1.39)					
		2710 (12.05)	802 (3.57)	3113 (13.85)	2043 (9.09)	1421 (6.32)					
36 (914)	B72 B72A	313** (1.39)	188 (0.83)	473 (2.10)	201** (0.89)	—					
		1421 (6.32)	569 (2.53)	2135 (9.50)	909 (4.04)	631** (2.81)					
36 (1219)	B72 B72A	177** (0.79)	122 (0.54)	267** (1.19)	—	—					
		799 (3.55)	404 (1.80)	1211 (5.39)	512** (2.28)	355** (1.58)					
60 (1524)	B72 B72A	113** (0.50)	85 (0.38)	171** (0.76)	—	—					
		512** (2.28)	298 (1.32)	775 (3.45)	327** (1.45)	—					

**Where the slenderness ratio $\frac{KL}{r}$ exceeds 200, and K = end fixity factor, L = actual length and r = radius of gyration.

Reference page 201 for general fitting specifications.

Mini Channel Nuts & Fittings

Nuts for B62, B72 Channel

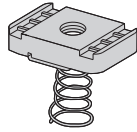

Spring Nut

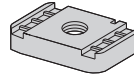

Nut Without Spring

B62		B72		Thread Size	Thickness		Wt./C	
With Spring	Without Spring	With Spring	Without Spring		In.	mm	Lbs.	kg
N621	N621WO	N7221	N621WO	#8-32	.150	(3.81)	1.0	(.45)
N622	N622WO	N7222	N622WO	#10-24	.150	(3.81)	1.0	(.45)
N627	N627WO	N7227	N627WO	#10-32	.150	(3.81)	1.0	(.45)
N624	N624WO	N7224	N624WO	1/4-20	.150	(3.81)	1.0	(.45)
BMM-3L	BMM-3	BMM-3S	BMM-3	M3.5 x 0.6	.150	(3.81)	1.0	(.45)
BMM-4L	BMM-4	BMM-4S	BMM-4	M4 x 0.7	.150	(3.81)	1.0	(.45)
BMM-5L	BMM-5	BMM-5S	BMM-5	M5 x 0.8	.150	(3.81)	1.0	(.45)
BMM-6L	BMM-6	BMM-6S	BMM-6	M6 x 1	.150	(3.81)	1.0	(.45)

Mini Fittings

B6202 Square Washer

- Standard finishes: ZN, GRN
- Wt./C 2 Lbs. (.9 kg)

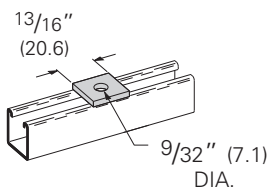

B6129 Two Hole Splice Plate

- Standard finishes: ZN, GRN
- Wt./C 5 Lbs. (2.2 kg)

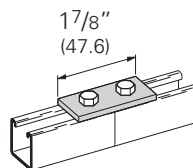

B6340 Two Hole Splice Plate

- Standard finishes: ZN, GRN
- Wt./C 5 Lbs. (2.2 kg)

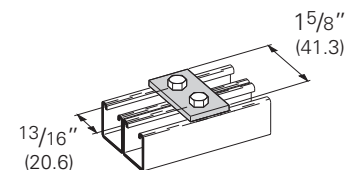

Reference page 201 for general fitting specifications.

Mini Fittings

B6141 Three Hole Splice Plate

- Standard finishes: ZN, GRN
- Wt./C 7 Lbs. (3.2 kg)

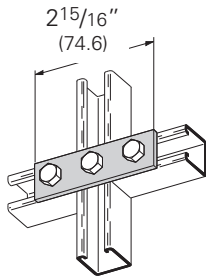

B600-62 Three Hole Flat Adapter Plate

- Standard finishes: ZN, GRN
- Wt./C 19 Lbs. (8.6 kg)

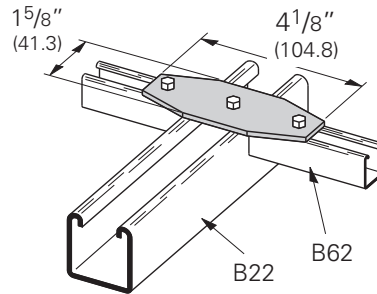

B6557 Three Hole Splice Plate

- Standard finishes: ZN, GRN
- Wt./C 7 Lbs. (3.2 kg)

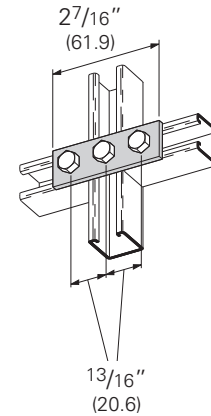

B6341 Four Hole Splice Plate

- Standard finishes: ZN, GRN
- Wt./C 11 Lbs. (5.0 kg)

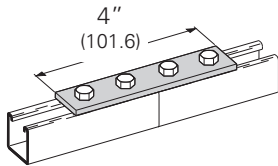

B6138 Two Hole Swivel Plate

- Standard finishes: ZN, GRN
- Wt./C 7 Lbs. (3.2 kg)

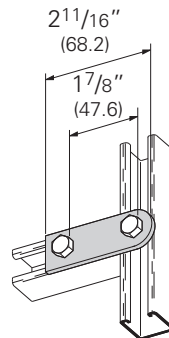

B6139 Three Hole Swivel Plate

- Standard finishes: ZN, GRN
- Wt./C 10 Lbs. (4.5 kg)

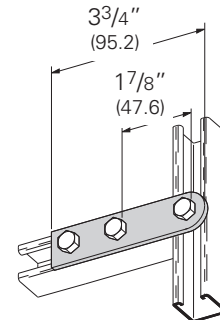

B6504 Four Hole Splice Plate

- Standard finishes: ZN, GRN
- Wt./C 10 Lbs. (4.5 kg)

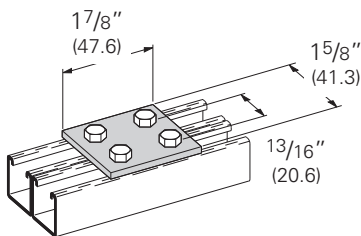

B6140 Three Hole Corner Plate

- Standard finishes: ZN, GRN
- Wt./C 8 Lbs. (3.6 kg)

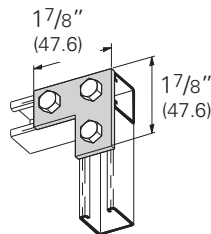

B6143 Four Hole Corner Plate

- Standard finishes: ZN, GRN
- Wt./C 11 Lbs. (5.0 kg)

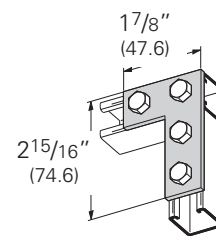

Reference page 201 for general fitting specifications.

B6133
Four Hole Tee Plate

- Standard finishes: ZN, GRN
- Wt./C 11 Lbs. (5.0 kg)

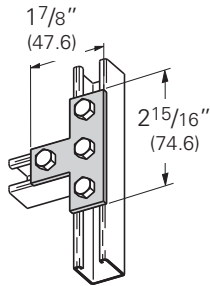

B6132
Five Hole Cross Plate

- Standard finishes: ZN, GRN
- Wt./C 13 Lbs. (5.9 kg)

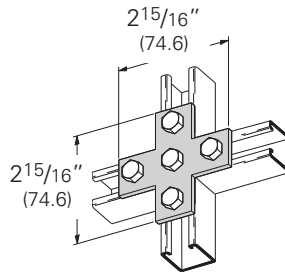

B6135
Three Hole Corner Gusset Plate

- Standard finishes: ZN, GRN
- Wt./C 9 Lbs. (4.1 kg)

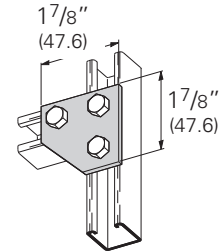

B6142
Four Hole Corner Gusset Plate

- Standard finishes: ZN, GRN
- Wt./C 15 Lbs. (6.8 kg)

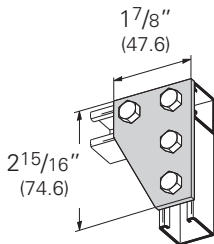

B6337
Three Hole Tee Gusset Plate

- Standard finishes: ZN, GRN
- Wt./C 10 Lbs. (4.5 kg)

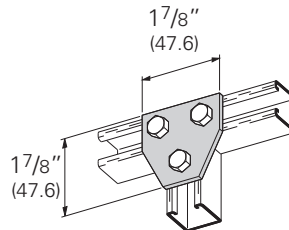

B6136
Four Hole Tee Gusset Plate

- Standard finishes: ZN, GRN
- Wt./C 15 Lbs. (6.8 kg)

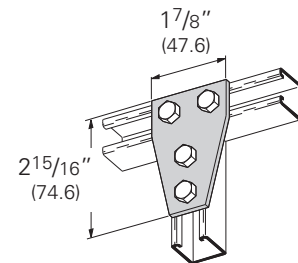

B6532
Five Hole Tee Gusset Plate

- Standard finishes: ZN, GRN
- Wt./C 22 Lbs. (10.0 kg)

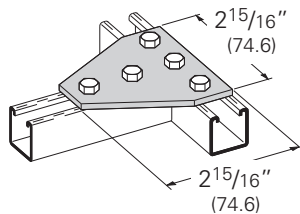

B6101
Two Hole Corner Angle

- Standard finishes: ZN, GRN
- Wt./C 5 Lbs. (2.2 kg)

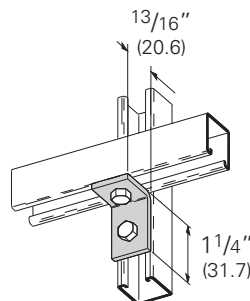

B6230
Two Hole Corner Angle

- Standard finishes: ZN, GRN
- Wt./C 5 Lbs. (2.2 kg)

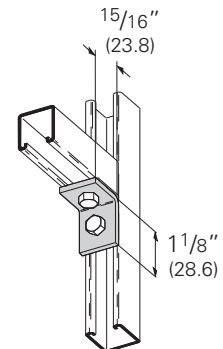

Reference page 201 for general fitting specifications.

Mini Fittings

B6102 Three Hole Corner Angle

- Standard finishes: ZN, GRN
- Wt./C 8 Lbs. (3.6 kg)

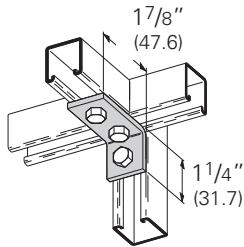

B6103 Three Hole Corner Angle

- Standard finishes: ZN, GRN
- Wt./C 8 Lbs. (3.6 kg)

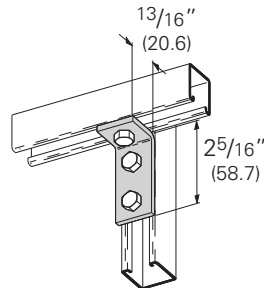

B6232 Three Hole Corner Angle

- Standard finishes: ZN, GRN
- Wt./C 7 Lbs. (3.2 kg)

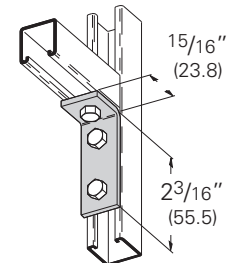

B6374 Three Hole Corner Angle

- Standard finishes: ZN, GRN
- Wt./C 7 Lbs. (3.2 kg)

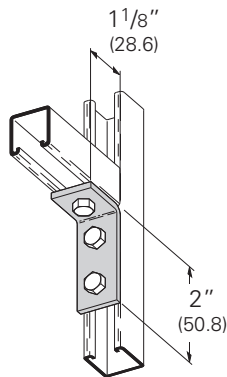

B6104 Four Hole Corner Angle

- Standard finishes: ZN, GRN
- Wt./C 10 Lbs. (4.5 kg)

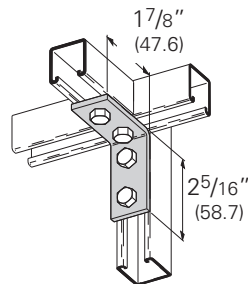

B6558 Four Hole Corner Angle

- Standard finishes: ZN, GRN
- Wt./C 10 Lbs. (4.5 kg)

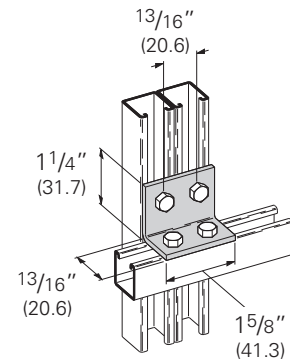

B6357 Four Hole Offset Bent Tee

- Standard finishes: ZN, GRN
- Wt./C 11 Lbs. (5.0 kg)

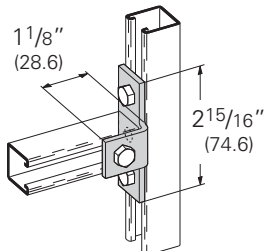

B6239 Five Hole Offset Bent Tee

- Standard finishes: ZN, GRN
- Wt./C 14 Lbs. (6.3 kg)

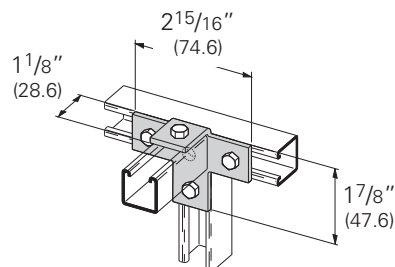

B6144R & L Four Hole Shelf Bracket

- Standard finishes: ZN, GRN
- Wt./C 19 Lbs. (8.6 kg)

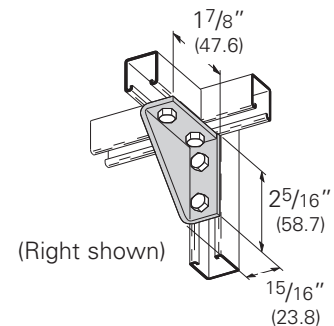

Reference page 201 for general fitting specifications.

B6134R & L Four Hole Corner Gusset

- Standard finishes: ZN, GRN
- Wt./C 15 Lbs. (6.8 kg)

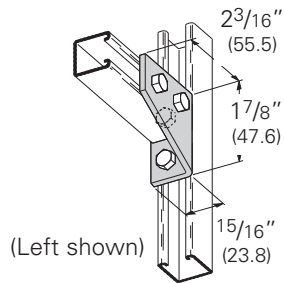

B6234R & L Four Hole Corner Gusset

- Standard finishes: ZN, GRN
- Wt./C 15 Lbs. (6.8 kg)

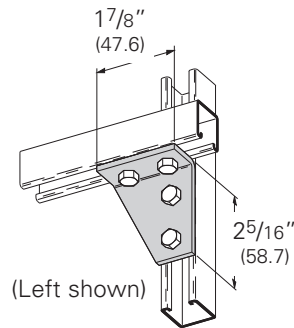

B6118 Four Hole Gussetted Shelf Angle

- Standard finishes: ZN, GRN
- Wt./C 15 Lbs. (6.8 kg)

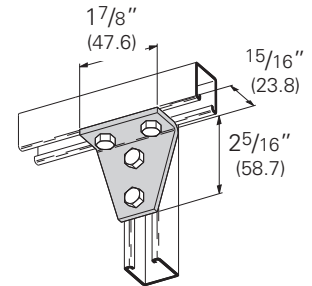

B6533 Five Hole Gussetted Shelf Angle

- Standard finishes: ZN, GRN
- Wt./C 22 Lbs. (10.0 kg)

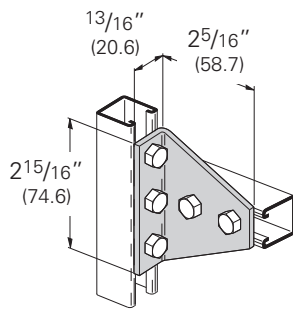

B6126 Four Hole Gussetted Three Way Shelf Angle

- Standard finishes: ZN, GRN
- Wt./C 15 Lbs. (6.8 kg)

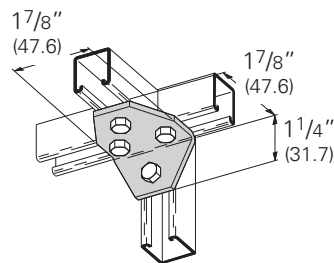

B6127 Five Hole Gussetted Three Way Shelf Angle

- Standard finishes: ZN, GRN
- Wt./C 18 Lbs. (8.1 kg)

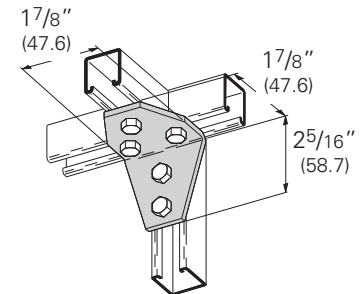

B6112 Four Hole Adjustable Corner Angle

- Standard finishes: ZN, GRN
- Wt./C 32Lbs. (14.5 kg)

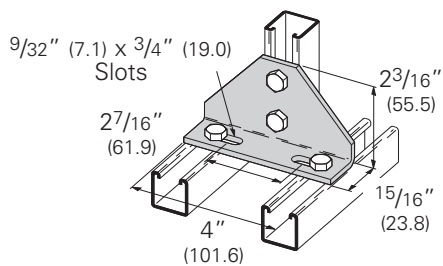

B589-62 Two Hole 90° Adapter Angle

- Standard finishes: ZN, GRN
- Wt./C 11 Lbs. (5.0 kg)

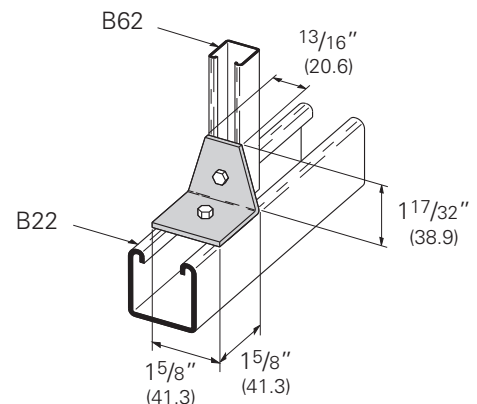

Reference page 201 for general fitting specifications.

Mini Fittings

B6147-B6152 Two Hole Open Angle

- Standard finishes: ZN, GRN

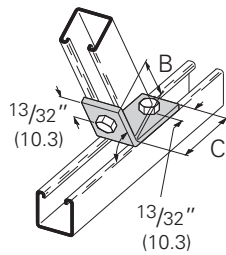

Part No.	A	B		C		Wt./C	
		In.	mm	In.	mm	Lbs.	kg
B6147	82 ¹ / ₂ °	2 ¹ / ₃₂ "	(51.6)	2 ⁷ / ₃₂ "	(21.4)	8.0	(3.6)
B6148	75°	2 ¹ / ₃₂ "	(51.6)	2 ⁷ / ₃₂ "	(21.4)		
B6149	67 ¹ / ₂ °	2"	(50.8)	7 ⁷ / ₈ "	(22.2)		
B6150	60°	1 ³¹ / ₃₂ "	(50.0)	1 ⁵ / ₁₆ "	(23.8)		
B6151	52 ¹ / ₂ °	1 ⁷ / ₈ "	(47.6)	1 ¹ / ₁₆ "	(27.0)		
B6152	37 ¹ / ₂ °	2"	(50.8)	2 ⁹ / ₃₂ "	(23.0)		

B6154 Two Hole Open Angle

- Standard finishes: ZN, GRN
- Wt./C 8 Lbs. (3.6 kg)

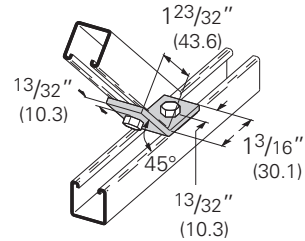

B6162-B6165 Two Hole Open Angle

- Standard finishes: ZN, GRN

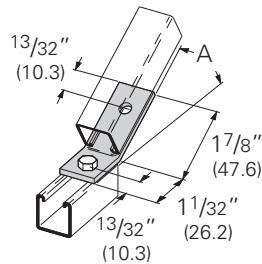

Part No.	A	Wt./C	
		Lbs.	kg
B6162	30°	8.0	(3.6)
B6163	22 ¹ / ₂ °		
B6164	15°		
B6165	7 ¹ / ₂ °		

B6156-B6161 Two Hole Closed Angle

- Standard finishes: ZN, GRN

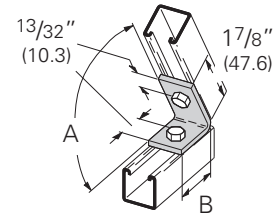

Part No.	A	B		Wt./C	
		In.	mm	Lbs.	kg
B6156	82 ¹ / ₂ °	1 ⁹ / ₃₂ "	(32.5)	8.0	(3.6)
B6157	75°	1 ⁵ / ₁₆ "	(33.3)		
B6158	67 ¹ / ₂ °	1 ³ / ₈ "	(34.9)		
B6159	60°	1 ¹³ / ₃₂ "	(35.7)		
B6160	52 ¹ / ₂ °	1 ¹⁵ / ₃₂ "	(37.3)		
B6161	37 ¹ / ₂ °	1 ²¹ / ₃₂ "	(42.0)		

B6155 Two Hole Closed Angle

- Standard finishes: ZN, GRN
- Wt./C 8 Lbs. (3.6 kg)

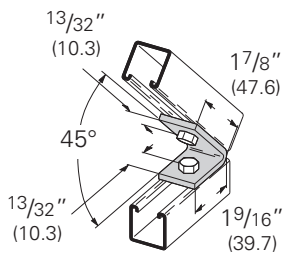

B601-62 Two Hole 45° Adapter Angle

- Standard finishes: ZN, GRN
- Wt./C 14 Lbs. (6.3 kg)

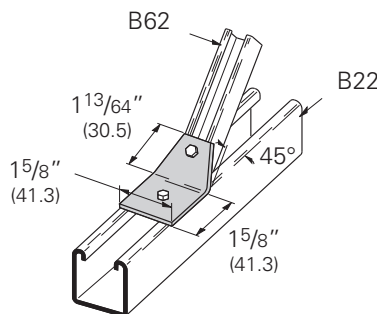

B6169 Two Hole Splice Clevis for B72

- Standard finishes: ZN, GRN
- Wt./C 11 Lbs. (5.0 kg)

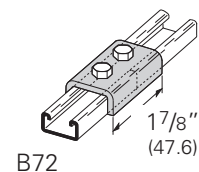

Reference page 201 for general fitting specifications.

B6168
Three Hole Splice Clevis for B72

- Standard finishes: ZN, GRN
- Wt./C 16 Lbs. (7.2 kg)

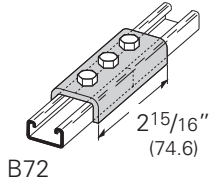

B6167
Four Hole Splice Clevis for B72

- Standard finishes: ZN, GRN
- Wt./C 24 Lbs. (10.9 kg)

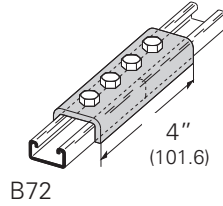

B6170
Two Hole Splice Clevis for B62

- Standard finishes: ZN, GRN
- Wt./C 17 Lbs. (7.7 kg)

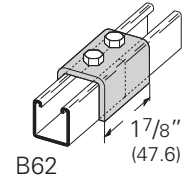

B6171
Three Hole Splice Clevis for B62

- Standard finishes: ZN, GRN
- Wt./C 26 Lbs. (11.8 kg)

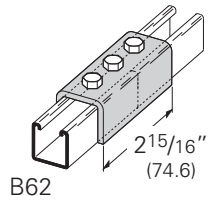

B6172
Four Hole Splice Clevis for B62

- Standard finishes: ZN, GRN
- Wt./C 36 Lbs. (16.3 kg)

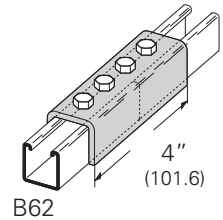

B7116
Three Hole U-Support

- Standard finishes: ZN, GRN
- Wt./C 10 Lbs. (4.5 kg)

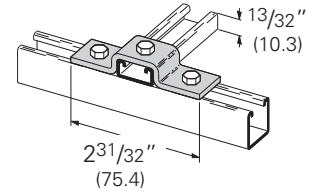

B6107
Three Hole U-Support

- Standard finishes: ZN, GRN
- Wt./C 12 Lbs. (5.4 kg)

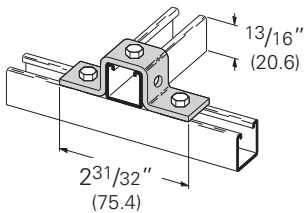

B6107-62A
Three Hole U-Support

- Standard finishes: ZN, GRN
- Wt./C 16 Lbs. (7.2 kg)

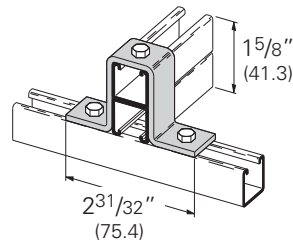

B6594
Five Hole U-Support

- Standard finishes: ZN, GRN
- Wt./C 13 Lbs. (5.9 kg)

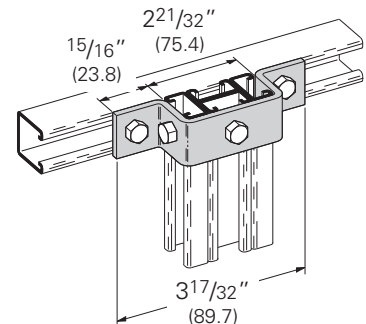

Reference page 201 for general fitting specifications.

Mini Fittings

B6173 Four Hole Clevis

- Standard finishes: ZN, GRN
- Wt./C 9 Lbs. (4.1 kg)

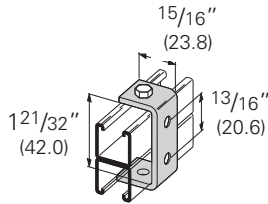

B6526 Two Hole Offset Z-Support

- Standard finishes: ZN, GRN
- Wt./C 5 Lbs. (2.2 kg)

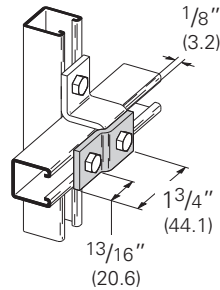

B6105 Two Hole Offset Z-Support for B62

- Standard finishes: ZN, GRN
- Wt./C 7 Lbs. (3.2 kg)

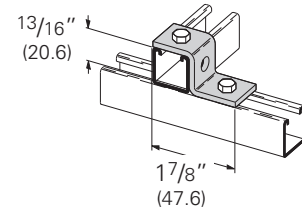

B7105 Two Hole Offset Z-Support for B72

- Standard finishes: ZN, GRN
- Wt./C 7 Lbs. (3.2 kg)

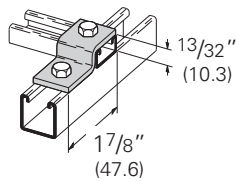

B6110 Two Hole Offset Z-Support for B62A

- Standard finishes: ZN, GRN
- Wt./C 9 Lbs. (4.1 kg)

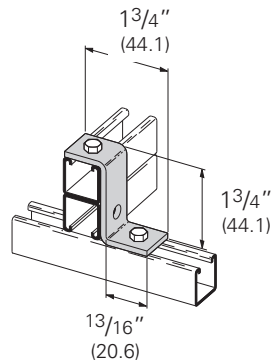

B6108 Two Hole Offset Z-Support

- Standard finishes: ZN, GRN
- Wt./C 7 Lbs. (3.2 kg)

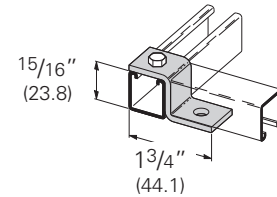

B598-62 Two Hole Z-Adapter Plate

- Standard finishes: ZN, GRN
- Wt./C 28 Lbs. (12.7 kg)

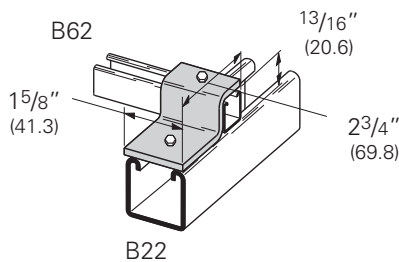

B6571 eight Hole Wing Connection

- Standard finishes: ZN, GRN
- Wt./C 28 Lbs. (12.7 kg)

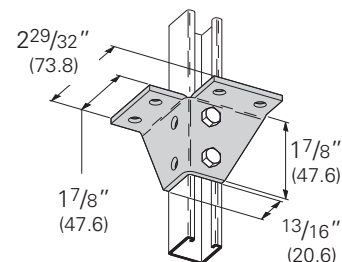

Reference page 201 for general fitting specifications.

B6205 End Cap for B62

- Material: ASTM A1008 SS Gr. 33 Type 1
- Standard finishes: ZN, GRN
- Wt./C 3 Lbs. (1.3 kg)

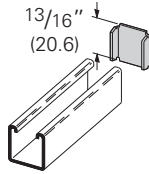

B7205 End Cap for B72

- Material: ASTM A1008 SS Gr. 33 Type 1
- Standard finishes: ZN, GRN
- Wt./C 1 Lb. (.4 kg)

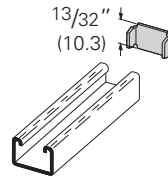

B6211 Z-Beam Clamp

- 5/16"-18 Setscrew included
- 13/16" (20.6) Max. Flange Thickness
- Material: ASTM A36
- Standard finishes: ZN, GRN
- Wt./C 13 Lbs. (5.9 kg)

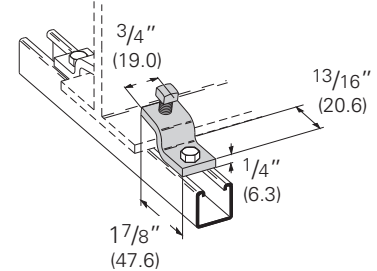

B6409-6, 9 Bracket

- Safety Factor of 2
- Uniform Design Load 40 Lbs. (.18 kN)
- Standard finishes: ZN, GRN

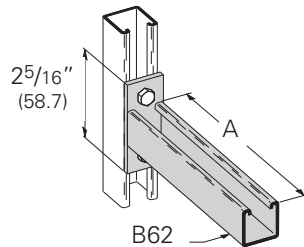

Part No.	A		Wt./C	
	In.	mm	Lbs.	kg
B6409-6	6"	(152.4)	28.0	(12.7)
B6409-9	9"	(228.6)	35.0	(15.8)

B2350-B2355 One Hole Double Tubing Strap

- Material: ASTM A1008 SS Gr. 33 Type 1
- Standard finishes: ZN, GRN

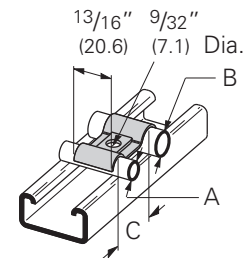

Part No.	O.D. Size A		O.D. Size B		C		Wt./C	
	In.	mm	In.	mm	In.	mm	Lbs.	kg
B2350	1/4"	(6.3)	1/4"	(6.3)	3/4"	(19.0)	1.2	(.5)
B2351	3/8"	(9.5)	3/8"	(9.5)	1"	(25.4)	2.0	(.9)
B2352	1/2"	(12.7)	1/2"	(12.7)	1 1/4"	(31.7)	2.9	(1.3)
B2353	1/4"	(6.3)	3/8"	(9.5)	7/8"	(22.2)	1.6	(.7)
B2354	1/4"	(6.3)	1/2"	(12.7)	1"	(25.4)	2.1	(.9)
B2355	3/8"	(9.5)	1/2"	(12.7)	1 1/8"	(28.6)	2.5	(1.1)

B2308-B2315 One Hole Tubing Strap

- Material: Sizes 1/4" - 1/2", ASTM A611 Gr. C
5/8" - 1", ASTM A1008 SS Gr. 33 Type 1
- Standard finishes: ZN, GRN

Part No.	O.D. Size A		B		C		Wt./C	
	In.	mm	In.	mm	In.	mm	Lbs.	kg
B2308	1/4"	(6.3)	1 1/32"	(26.2)	.048	(1.2)	1.2	(.5)
B2309	5/16"	(7.9)	1 3/32"	(27.8)	.048	(1.2)	1.4	(.6)
B2310	3/8"	(9.5)	1 3/16"	(30.1)	.048	(1.2)	1.6	(.7)
B2311	1/2"	(12.7)	1 21/64"	(33.7)	.048	(1.2)	1.9	(.8)
B2312	5/8"	(15.9)	1 25/64"	(35.3)	.062	(1.6)	2.7	(1.2)
B2313	3/4"	(19.0)	1 39/64"	(40.9)	.075	(1.9)	4.3	(1.9)
B2314	7/8"	(22.2)	1 51/64"	(45.6)	.075	(1.9)	4.9	(2.2)
B2315	1"	(25.4)	2 1/32"	(51.6)	.075	(1.9)	5.2	(2.3)

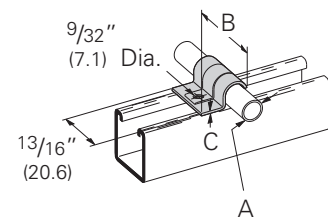

Reference page 201 for general fitting specifications.

Mini Channel & Fittings

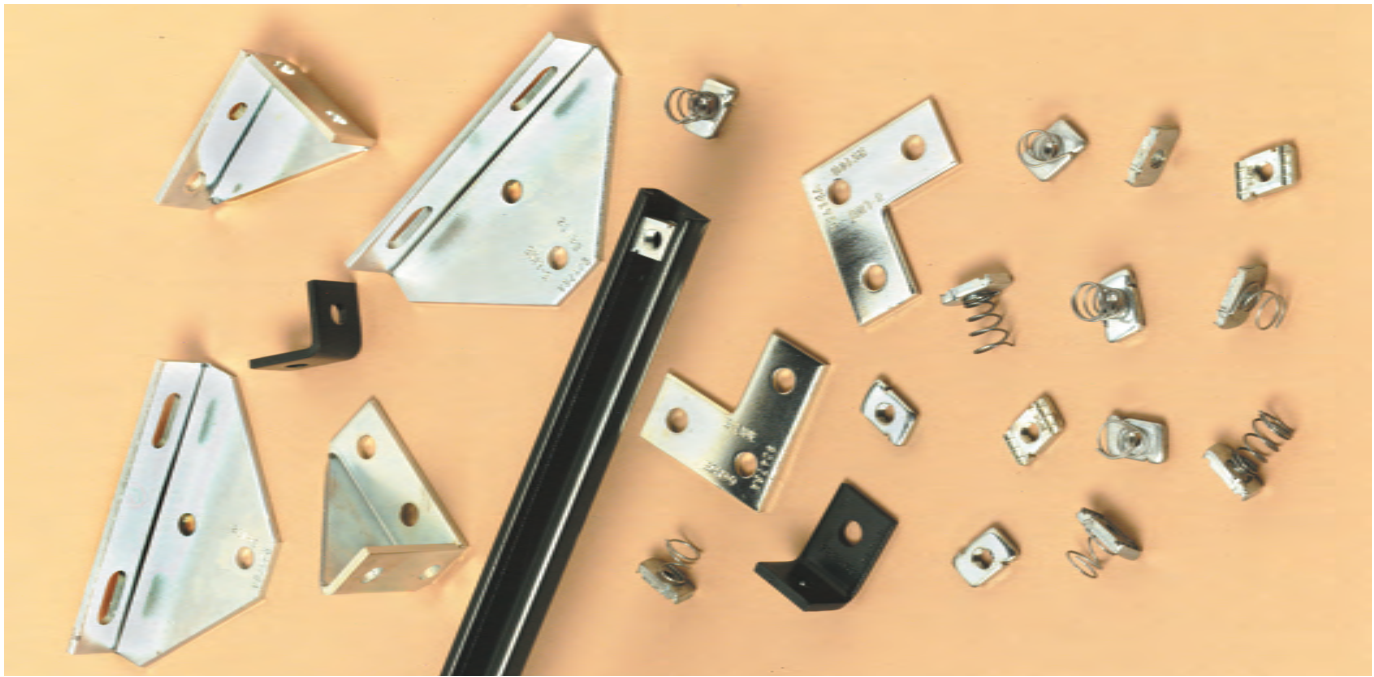

Our mini channels and fittings provide for an economical method of supporting light load requirements on a strut system.

Channel

Channels are cold formed on our modern rolling mills from 18 Ga. (1.2 mm) low carbon steel strips plain steel (ASTM A1008 33,000 PSI min. yield) and pre-galvanized steel strips, (ASTM A653 33,000 PSI min. yield). A continuous slot with inturned lips provides the ability to make attachments at any point. Channel combinations are made with new state of the art, high-tech welding equipment.

Lengths

Standard lengths are 10' (3.05 m) and 20' (6.09 m) for B62 series, and 10' (3.05 m) for B72 series. Custom lengths are available.

Fittings

Mini fittings are formed from hot rolled pickled and oiled strip or sheet steel (ASTM A1011, HSLAS, Grade 50, Class1). The following dimensions apply to all fittings except as noted on the drawings:

Hole Size – $9/32$ " (7.14 mm) Dia.

Hole Spacing – $13/32$ " (10.3 mm) from end and $1\ 1/16$ " (27.0 mm) on center.

Width – $13/16$ " (20.6 mm)

Thickness – $1/8$ " (3.2 mm)

Materials & Finishes*

*Unless otherwise noted.

Finish Code	Finish	Specification
PLN	Plain	ASTM A1011, HSLAS, Grade 50, Class 1
ZN	Electro-Plated Zinc	ASTM B633 SC3 Type II
GRN	DURA-GREEN™	
GLV	Pre-Galvanized	ASTM A653 33,000 PSI min. yield
HDG	Hot-Dipped Galvanized	ASTM A123

Metric

Metric dimensions are shown in parentheses. Unless noted, all metric dimensions are in millimeters.

B62 Channel

- Thickness: 18 Ga. (1.2 mm)
- Standard lengths: 10' (3.05 m) & 20' (6.09 m)
- Standard finishes: Plain, DURA GREEN™, Pre-Galvanized
- Weight: .42 Lbs./Ft. (.62 kg/m)

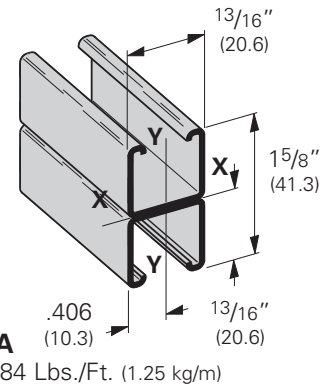
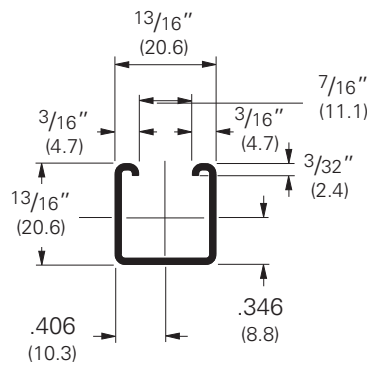
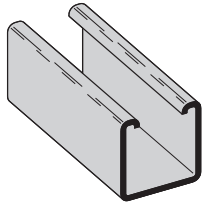

B62A
Wt. .84 Lbs./Ft. (1.25 kg/m)

Section Properties

Channel	Weight lbs./ft. kg/m	Areas of Section sq. in. cm ²	X - X Axis				Y - Y Axis			
			Moment of Inertia (I) in. ⁴ cm ⁴	Section Modulus (S) in. ³ cm ³	Radius of Gyration (r) in. cm	Moment of Inertia (I) in. ⁴ cm ⁴	Section Modulus (S) in. ³ cm ³	Radius of Gyration (r) in. cm		
B62	.420 (.62)	.123 (.80)	.0103 (.43)	.0221 (.36)	.289 (.73)	.0134 (.56)	.0330 (.54)	.330 (.84)		
B62A	.839 (1.25)	.247 (1.59)	.0500 (2.08)	.0616 (1.01)	.450 (1.14)	.0269 (1.12)	.0663 (1.09)	.330 (.84)		

Calculations of section properties are based on metal thicknesses as determined by the AISI Cold-Formed Steel Design Manual.

Beam Loading

Beam Span In. mm	Channel Style	Uniform Load and Deflection		Uniform Load @ Deflection =			
		Lbs. kN	In. mm	1/240 Span	1/360 Span		
		Lbs. kN	In. mm	Lbs. kN	Lbs. kN	Lbs. kN	
12 (305)	B62	364 (1.62)	.027 (.68)	364 (1.62)	364 (1.62)	364 (1.62)	
	B62A	420* (1.87)	.006 (.15)	420* (1.87)	420* (1.87)	420* (1.87)	
24 (609)	B62	182 (0.81)	.109 (2.77)	167 (0.74)	111 (0.49)	111 (0.49)	
	B62A	420* (1.87)	.051 (1.29)	420* (1.87)	420* (1.87)	420* (1.87)	
36 (914)	B62	121 (0.54)	.245 (6.22)	74 (0.33)	50 (0.22)	50 (0.22)	
	B62A	341 (1.51)	.141 (3.58)	341 (1.51)	242 (1.07)	242 (1.07)	
48 (1219)	B62	91 (0.40)	.436 (11.07)	42 (0.18)	28 (0.12)	28 (0.12)	
	B62A	256 (1.14)	.250 (6.35)	204 (0.91)	136 (0.60)	136 (0.60)	
60 (1524)	B62	73 (0.32)	.681 (17.30)	27 (0.12)	18 (0.08)	18 (0.08)	
	B62A	205 (0.91)	.391 (9.93)	131 (0.58)	87 (0.39)	87 (0.39)	
72 (1829)	B62	61 (0.27)	.981 (24.92)	19 (0.08)	12 (0.05)	12 (0.05)	
	B62A	170 (0.75)	.563 (14.30)	91 (0.40)	61 (0.27)	61 (0.27)	

Based on simple beam condition using an allowable design stress of 25,000 psi (172 MPa) in accordance with MFMA, with adequate lateral bracing (see page 12 for further explanation). Actual yield point of cold rolled steel is 42,000 psi. To determine concentrated load capacity at mid span, multiply uniform load by 0.5 and corresponding deflection by 0.8. *Failure determined by weld shear.

Column Loading

Unbraced Height In. mm	Channel Style	Max. Column Loading K = .80		Max. Column Loading (Loaded @ C.G.)							
		Loaded @ C.G.		Loaded @ Slot Face		K = .65		K = 1.0		K = 1.2	
		Lbs. kN	Lbs. kN	Lbs. kN	Lbs. kN	Lbs. kN	Lbs. kN	Lbs. kN	Lbs. kN		
12 (305)	B62	2052 (9.13)	820 (3.65)	2161 (9.61)	1890 (8.41)	1715 (7.63)					
	B62A	4666 (20.75)	1449 (6.44)	4710 (20.95)	4593 (20.43)	4503 (20.03)					
24 (609)	B62	1350 (6.00)	645 (2.87)	1624 (7.22)	1020 (4.54)	818 (3.64)					
	B62A	4275 (19.01)	1367 (6.08)	4453 (19.81)	3982 (17.71)	3624 (16.12)					
36 (914)	B62	818 (3.64)	471 (2.09)	1053 (4.68)	633 (2.81)	515 (2.29)					
	B62A	3624 (16.12)	847 (3.77)	4023 (17.89)	2965 (13.19)	2179 (9.69)					
48 (1219)	B62	589 (2.62)	369 (1.64)	745 (3.31)	456 (2.03)	365** (1.62)					
	B62A	2713 (12.06)	504 (2.24)	3421 (15.21)	1765 (7.85)	1225 (5.45)					
60 (1524)	B62	456 (2.03)	300 (1.33)	579 (2.57)	347** (1.54)	271** (1.20)					
	B62A	1765 (7.85)	323 (1.44)	2647 (11.77)	1129 (5.02)	784** (3.49)					
72 (1829)	B62	365** (1.62)	248 (1.10)	470 (2.09)	271** (1.20)	-					
	B62A	1225 (5.45)	224 (0.99)	1856 (8.25)	784** (3.49)	545** (2.42)					

**Where the slenderness ratio $\frac{KL}{r}$ exceeds 200, and K = end fixity factor, L = actual length and r = radius of gyration.

Reference page 201 for general fitting specifications.

B72 Channel

- Thickness: 18 Ga. (1.2 mm)
- Standard lengths: 10' (3.05 m) & 20' (6.09 m)
- Standard finishes: Plain, DURA GREEN™, Pre-Galvanized
- Weight: .29 Lbs./Ft. (.43 kg/m)

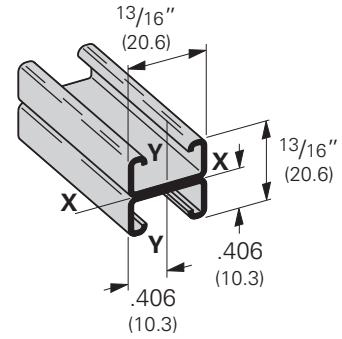
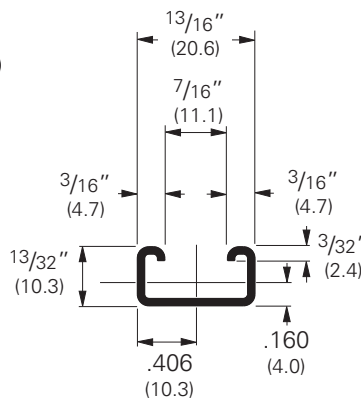
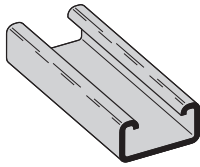

B72A
Wt. .58 Lbs./Ft. (.87 kg/m)

Section Properties

Channel	Weight lbs./ft. kg/m	Areas of Section sq. in. cm ²	X - X Axis				Y - Y Axis			
			Moment of Inertia (I) in. ⁴ cm ⁴	Section Modulus (S) in. ³ cm ³	Radius of Gyration (r) in. cm	Moment of Inertia (I) in. ⁴ cm ⁴	Section Modulus (S) in. ³ cm ³	Radius of Gyration (r) in. cm		
B72	.287 (.43)	.084 (.54)	.0018 (.07)	.0073 (.12)	.146 (.37)	.0077 (.32)	.0190 (.31)	.302 (.77)		
B72A	.574 (.85)	.169 (1.09)	.0078 (.32)	.0192 (.31)	.215 (.55)	.0155 (.65)	.0382 (.63)	.303 (.77)		

Calculations of section properties are based on metal thicknesses as determined by the AISI Cold-Formed Steel Design Manual.

Beam Loading

Beam Span In. mm	Channel Style	Uniform Load and Deflection				Uniform Load @ Deflection =			
		Lbs. kN		In. mm		1/240 Span		1/360 Span	
12 (305)	B72	116 (0.51)	.051 (1.29)	113 (0.50)	75 (0.32)				
	B72A	210* (0.93)	.020 (.51)	210* (0.93)	210* (0.93)				
24 (609)	B72	58 (0.26)	.206 (5.23)	28 (0.12)	19 (0.08)				
	B72A	159 (0.71)	.125 (3.17)	127 (0.56)	85 (0.38)				
36 (914)	B72	39 (0.17)	.465 (11.81)	13 (0.06)	8 (0.03)				
	B72A	106 (0.45)	.281 (7.14)	57 (0.25)	38 (0.17)				
36 (1219)	B72	29 (0.13)	.827 (21.00)	7 (0.03)	5 (0.02)				
	B72A	80 (0.35)	.500 (12.70)	32 (0.14)	21 (0.09)				
60 (1524)	B72	23 (0.10)	1.292 (32.81)	5 (0.02)	3 (0.01)				
	B72A	64 (0.28)	.782 (19.86)	20 (0.09)	14 (0.06)				

Based on simple beam condition using an allowable design stress of 25,000 psi (172 MPa) in accordance with MFMA, with adequate lateral bracing (see page 12 for further explanation). Actual yield point of cold rolled steel is 42,000 psi. To determine concentrated load capacity at mid span, multiply uniform load by 0.5 and corresponding deflection by 0.8. *Failure determined by weld shear.

Column Loading

Unbraced Height In. mm	Channel Style	Max. Column Loading K = .80				Max. Column Loading (Loaded @ C.G.)					
		Loaded @ C.G.		Loaded @ Slot Face		K = .65		K = 1.0		K = 1.2	
		Lbs. kN	Lbs. kN	Lbs. kN	Lbs. kN	Lbs. kN	Lbs. kN	Lbs. kN	Lbs. kN		
12 (305)	B72	1598 (7.11)	539 (2.40)	1712 (7.61)	1410 (6.27)	1181 (5.25)					
	B72A	3600 (16.01)	986 (4.38)	3700 (16.46)	3433 (15.27)	3229 (14.36)					
24 (609)	B72	701 (3.12)	320 (1.42)	1050 (4.67)	450 (2.00)	313** (1.39)					
	B72A	2710 (12.05)	802 (3.57)	3113 (13.85)	2043 (9.09)	1421 (6.32)					
36 (914)	B72	313** (1.39)	188 (0.83)	473 (2.10)	201** (0.89)	—					
	B72A	1421 (6.32)	569 (2.53)	2135 (9.50)	909 (4.04)	631** (2.81)					
36 (1219)	B72	177** (0.79)	122 (0.54)	267** (1.19)	—	—					
	B72A	799 (3.55)	404 (1.80)	1211 (5.39)	512** (2.28)	355** (1.58)					
60 (1524)	B72	113** (0.50)	85 (0.38)	171** (0.76)	—	—					
	B72A	512** (2.28)	298 (1.32)	775 (3.45)	327** (1.45)	—					

**Where the slenderness ratio $\frac{KL}{r}$ exceeds 200, and K = end fixity factor, L = actual length and r = radius of gyration.

Reference page 201 for general fitting specifications.

Mini Channel Nuts & Fittings

Nuts for B62, B72 Channel

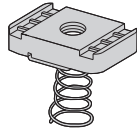

Spring Nut

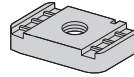

Nut Without Spring

B62		B72		Thread Size	Thickness		Wt./C	
With Spring	Without Spring	With Spring	Without Spring		In.	mm	Lbs.	kg
N621	N621WO	N7221	N621WO	#8-32	.150	(3.81)	1.0	(.45)
N622	N622WO	N7222	N622WO	#10-24	.150	(3.81)	1.0	(.45)
N627	N627WO	N7227	N627WO	#10-32	.150	(3.81)	1.0	(.45)
N624	N624WO	N7224	N624WO	1/4-20	.150	(3.81)	1.0	(.45)
BMM-3L	BMM-3	BMM-3S	BMM-3	M3.5 x 0.6	.150	(3.81)	1.0	(.45)
BMM-4L	BMM-4	BMM-4S	BMM-4	M4 x 0.7	.150	(3.81)	1.0	(.45)
BMM-5L	BMM-5	BMM-5S	BMM-5	M5 x 0.8	.150	(3.81)	1.0	(.45)
BMM-6L	BMM-6	BMM-6S	BMM-6	M6 x 1	.150	(3.81)	1.0	(.45)

Mini Fittings

B6202 Square Washer

- Standard finishes: ZN, GRN
- Wt./C 2 Lbs. (.9 kg)

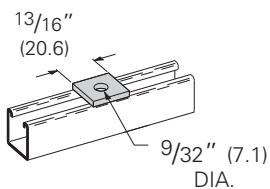

B6129 Two Hole Splice Plate

- Standard finishes: ZN, GRN
- Wt./C 5 Lbs. (2.2 kg)

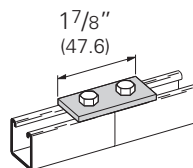

B6340 Two Hole Splice Plate

- Standard finishes: ZN, GRN
- Wt./C 5 Lbs. (2.2 kg)

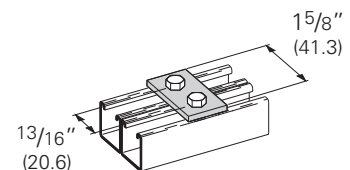

Reference page 201 for general fitting specifications.

Mini Fittings

B6141 Three Hole Splice Plate

- Standard finishes: ZN, GRN
- Wt./C 7 Lbs. (3.2 kg)

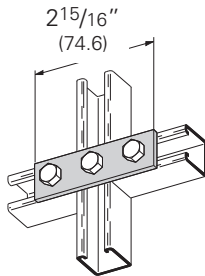

B600-62 Three Hole Flat Adapter Plate

- Standard finishes: ZN, GRN
- Wt./C 19 Lbs. (8.6 kg)

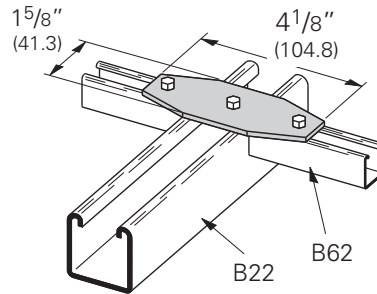

B6557 Three Hole Splice Plate

- Standard finishes: ZN, GRN
- Wt./C 7 Lbs. (3.2 kg)

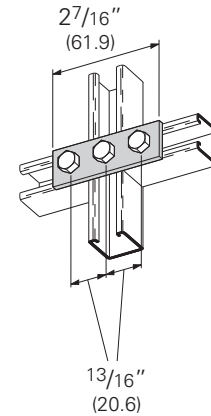

B6341 Four Hole Splice Plate

- Standard finishes: ZN, GRN
- Wt./C 11 Lbs. (5.0 kg)

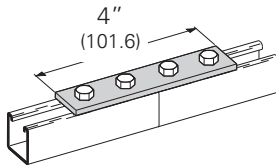

B6138 Two Hole Swivel Plate

- Standard finishes: ZN, GRN
- Wt./C 7 Lbs. (3.2 kg)

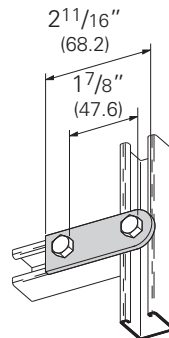

B6139 Three Hole Swivel Plate

- Standard finishes: ZN, GRN
- Wt./C 10 Lbs. (4.5 kg)

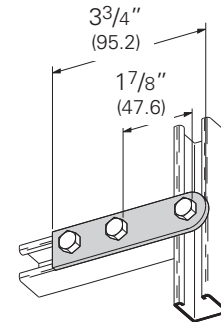

B6504 Four Hole Splice Plate

- Standard finishes: ZN, GRN
- Wt./C 10 Lbs. (4.5 kg)

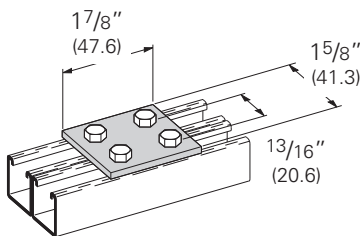

B6140 Three Hole Corner Plate

- Standard finishes: ZN, GRN
- Wt./C 8 Lbs. (3.6 kg)

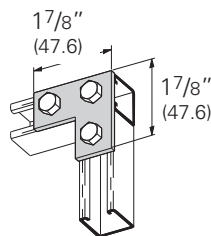

B6143 Four Hole Corner Plate

- Standard finishes: ZN, GRN
- Wt./C 11 Lbs. (5.0 kg)

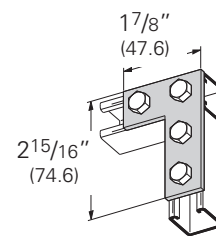

Reference page 201 for general fitting specifications.

B6133
Four Hole Tee Plate

- Standard finishes: ZN, GRN
- Wt./C 11 Lbs. (5.0 kg)

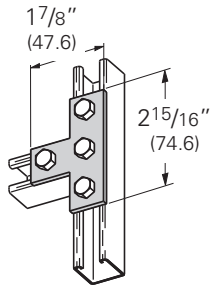

B6132
Five Hole Cross Plate

- Standard finishes: ZN, GRN
- Wt./C 13 Lbs. (5.9 kg)

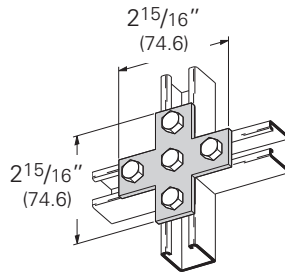

B6135
Three Hole Corner Gusset Plate

- Standard finishes: ZN, GRN
- Wt./C 9 Lbs. (4.1 kg)

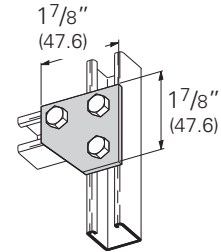

B6142
Four Hole Corner Gusset Plate

- Standard finishes: ZN, GRN
- Wt./C 15 Lbs. (6.8 kg)

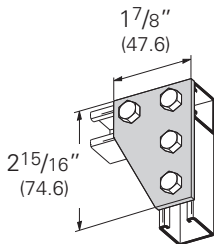

B6337
Three Hole Tee Gusset Plate

- Standard finishes: ZN, GRN
- Wt./C 10 Lbs. (4.5 kg)

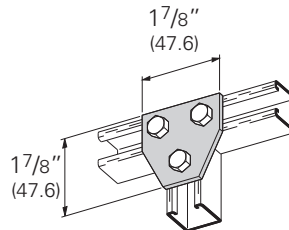

B6136
Four Hole Tee Gusset Plate

- Standard finishes: ZN, GRN
- Wt./C 15 Lbs. (6.8 kg)

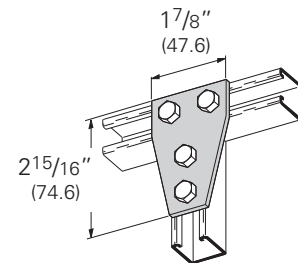

B6532
Five Hole Tee Gusset Plate

- Standard finishes: ZN, GRN
- Wt./C 22 Lbs. (10.0 kg)

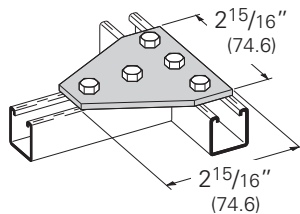

B6101
Two Hole Corner Angle

- Standard finishes: ZN, GRN
- Wt./C 5 Lbs. (2.2 kg)

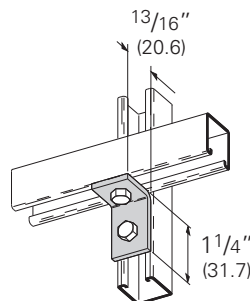

B6230
Two Hole Corner Angle

- Standard finishes: ZN, GRN
- Wt./C 5 Lbs. (2.2 kg)

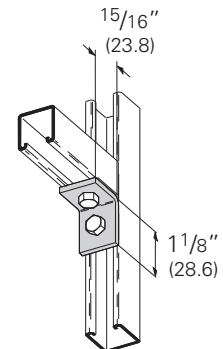

Reference page 201 for general fitting specifications.

Mini Fittings

B6102 Three Hole Corner Angle

- Standard finishes: ZN, GRN
- Wt./C 8 Lbs. (3.6 kg)

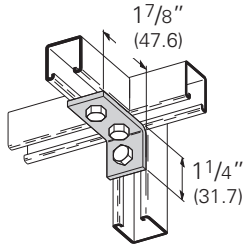

B6103 Three Hole Corner Angle

- Standard finishes: ZN, GRN
- Wt./C 8 Lbs. (3.6 kg)

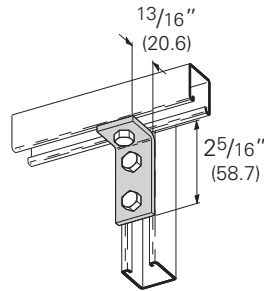

B6232 Three Hole Corner Angle

- Standard finishes: ZN, GRN
- Wt./C 7 Lbs. (3.2 kg)

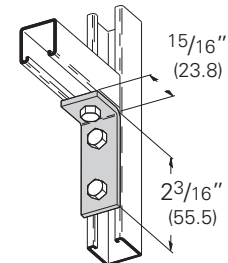

B6374 Three Hole Corner Angle

- Standard finishes: ZN, GRN
- Wt./C 7 Lbs. (3.2 kg)

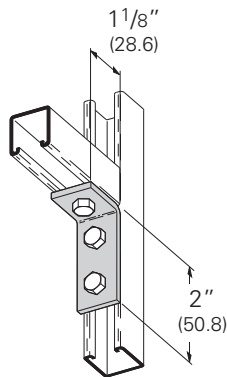

B6104 Four Hole Corner Angle

- Standard finishes: ZN, GRN
- Wt./C 10 Lbs. (4.5 kg)

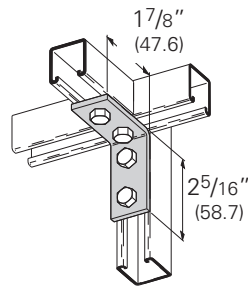

B6558 Four Hole Corner Angle

- Standard finishes: ZN, GRN
- Wt./C 10 Lbs. (4.5 kg)

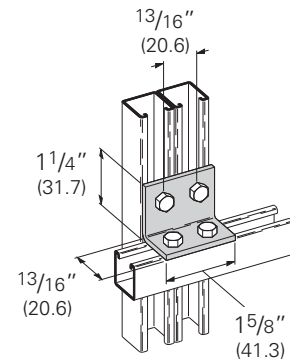

B6357 Four Hole Offset Bent Tee

- Standard finishes: ZN, GRN
- Wt./C 11 Lbs. (5.0 kg)

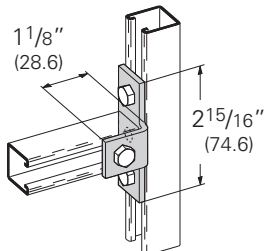

B6239 Five Hole Offset Bent Tee

- Standard finishes: ZN, GRN
- Wt./C 14 Lbs. (6.3 kg)

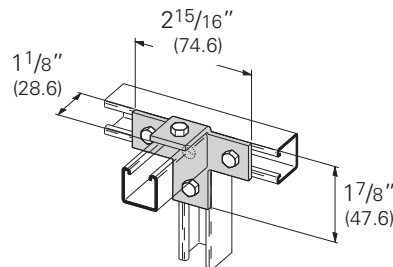

B6144R & L Four Hole Shelf Bracket

- Standard finishes: ZN, GRN
- Wt./C 19 Lbs. (8.6 kg)

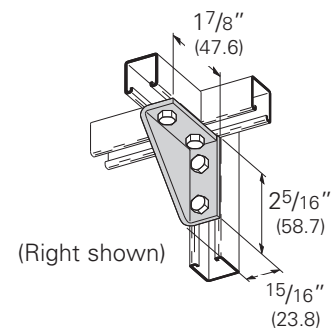

Reference page 201 for general fitting specifications.

B6134R & L Four Hole Corner Gusset

- Standard finishes: ZN, GRN
- Wt./C 15 Lbs. (6.8 kg)

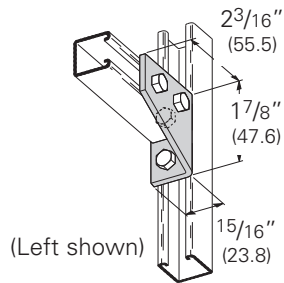

B6234R & L Four Hole Corner Gusset

- Standard finishes: ZN, GRN
- Wt./C 15 Lbs. (6.8 kg)

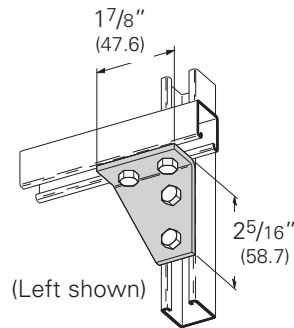

B6118 Four Hole Gussetted Shelf Angle

- Standard finishes: ZN, GRN
- Wt./C 15 Lbs. (6.8 kg)

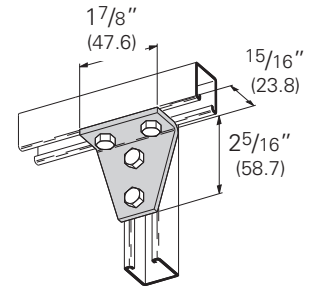

B6533 Five Hole Gussetted Shelf Angle

- Standard finishes: ZN, GRN
- Wt./C 22 Lbs. (10.0 kg)

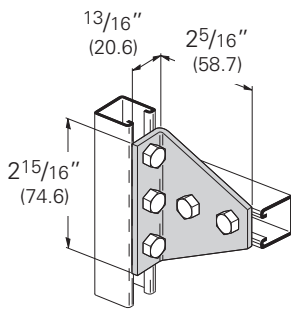

B6126 Four Hole Gussetted Three Way Shelf Angle

- Standard finishes: ZN, GRN
- Wt./C 15 Lbs. (6.8 kg)

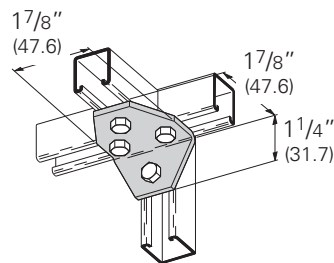

B6127 Five Hole Gussetted Three Way Shelf Angle

- Standard finishes: ZN, GRN
- Wt./C 18 Lbs. (8.1 kg)

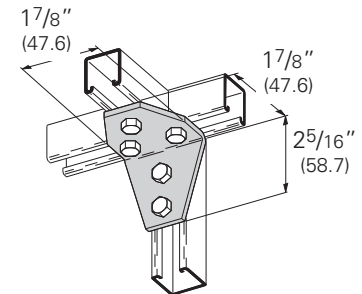

B6112 Four Hole Adjustable Corner Angle

- Standard finishes: ZN, GRN
- Wt./C 32Lbs. (14.5 kg)

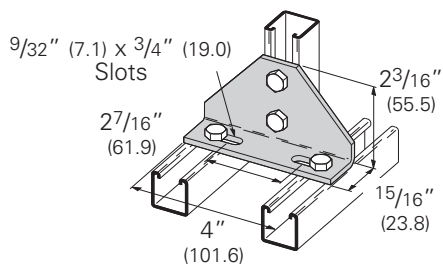

B589-62 Two Hole 90° Adapter Angle

- Standard finishes: ZN, GRN
- Wt./C 11 Lbs. (5.0 kg)

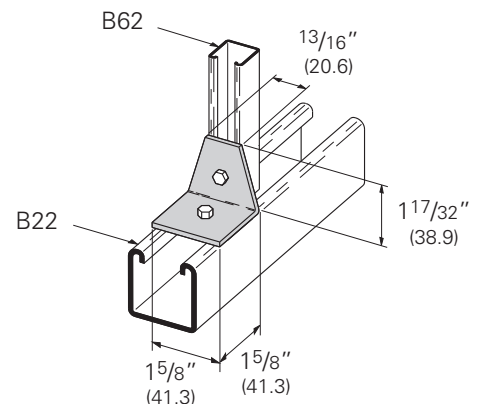

Reference page 201 for general fitting specifications.

Mini Fittings

B6147-B6152 Two Hole Open Angle

- Standard finishes: ZN, GRN

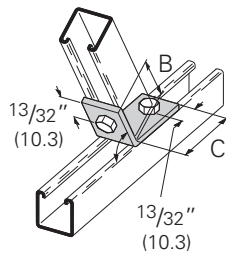

Part No.	A	B		C		Wt./C	
		In.	mm	In.	mm	Lbs.	kg
B6147	82 ¹ / ₂ °	2 ¹ / ₃₂ "	(51.6)	2 ⁷ / ₃₂ "	(21.4)	8.0	(3.6)
B6148	75°	2 ¹ / ₃₂ "	(51.6)	2 ⁷ / ₃₂ "	(21.4)		
B6149	67 ¹ / ₂ °	2"	(50.8)	7 ⁷ / ₈ "	(22.2)		
B6150	60°	1 ³¹ / ₃₂ "	(50.0)	1 ⁵ / ₁₆ "	(23.8)		
B6151	52 ¹ / ₂ °	1 ⁷ / ₈ "	(47.6)	1 ¹ / ₁₆ "	(27.0)		
B6152	37 ¹ / ₂ °	2"	(50.8)	2 ⁹ / ₃₂ "	(23.0)		

B6154 Two Hole Open Angle

- Standard finishes: ZN, GRN
- Wt./C 8 Lbs. (3.6 kg)

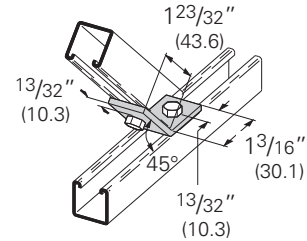

B6162-B6165 Two Hole Open Angle

- Standard finishes: ZN, GRN

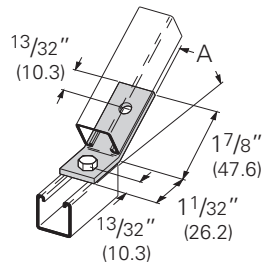

Part No.	A	Wt./C	
		Lbs.	kg
B6162	30°	8.0	(3.6)
B6163	22 ¹ / ₂ °		
B6164	15°		
B6165	7 ¹ / ₂ °		

B6156-B6161 Two Hole Closed Angle

- Standard finishes: ZN, GRN

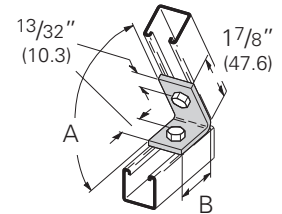

Part No.	A	B		Wt./C	
		In.	mm	Lbs.	kg
B6156	82 ¹ / ₂ °	1 ⁹ / ₃₂ "	(32.5)	8.0	(3.6)
B6157	75°	1 ⁵ / ₁₆ "	(33.3)		
B6158	67 ¹ / ₂ °	1 ³ / ₈ "	(34.9)		
B6159	60°	1 ¹³ / ₃₂ "	(35.7)		
B6160	52 ¹ / ₂ °	1 ¹⁵ / ₃₂ "	(37.3)		
B6161	37 ¹ / ₂ °	1 ²¹ / ₃₂ "	(42.0)		

B6155 Two Hole Closed Angle

- Standard finishes: ZN, GRN
- Wt./C 8 Lbs. (3.6 kg)

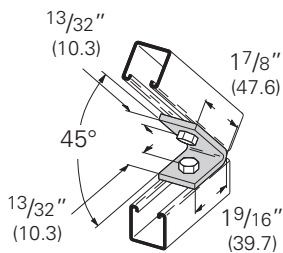

B601-62 Two Hole 45° Adapter Angle

- Standard finishes: ZN, GRN
- Wt./C 14 Lbs. (6.3 kg)

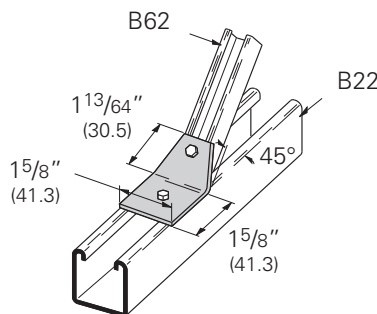

B6169 Two Hole Splice Clevis for B72

- Standard finishes: ZN, GRN
- Wt./C 11 Lbs. (5.0 kg)

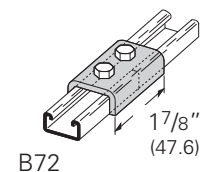

Reference page 201 for general fitting specifications.

B6168
Three Hole Splice Clevis for B72

- Standard finishes: ZN, GRN
- Wt./C 16 Lbs. (7.2 kg)

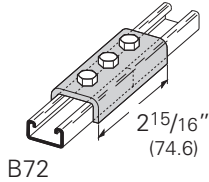

B6167
Four Hole Splice Clevis for B72

- Standard finishes: ZN, GRN
- Wt./C 24 Lbs. (10.9 kg)

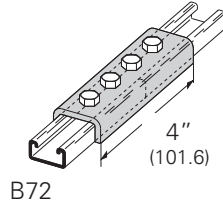

B6170
Two Hole Splice Clevis for B62

- Standard finishes: ZN, GRN
- Wt./C 17 Lbs. (7.7 kg)

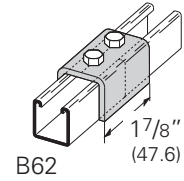

B6171
Three Hole Splice Clevis for B62

- Standard finishes: ZN, GRN
- Wt./C 26 Lbs. (11.8 kg)

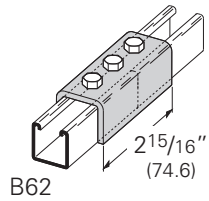

B6172
Four Hole Splice Clevis for B62

- Standard finishes: ZN, GRN
- Wt./C 36 Lbs. (16.3 kg)

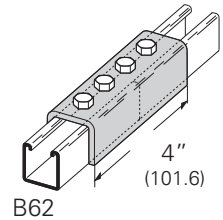

B7116
Three Hole U-Support

- Standard finishes: ZN, GRN
- Wt./C 10 Lbs. (4.5 kg)

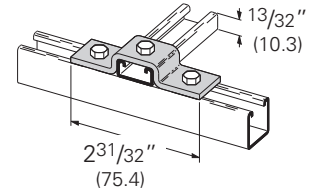

B6107
Three Hole U-Support

- Standard finishes: ZN, GRN
- Wt./C 12 Lbs. (5.4 kg)

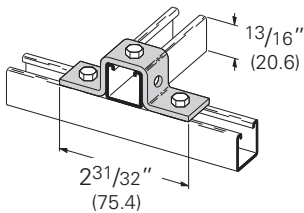

B6107-62A
Three Hole U-Support

- Standard finishes: ZN, GRN
- Wt./C 16 Lbs. (7.2 kg)

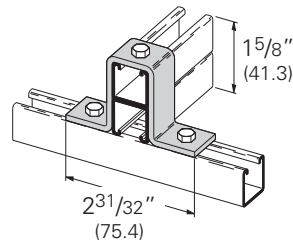

B6594
Five Hole U-Support

- Standard finishes: ZN, GRN
- Wt./C 13 Lbs. (5.9 kg)

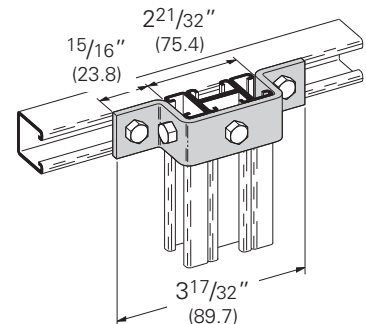

Reference page 201 for general fitting specifications.

Mini Fittings

B6173 Four Hole Clevis

- Standard finishes: ZN, GRN
- Wt./C 9 Lbs. (4.1 kg)

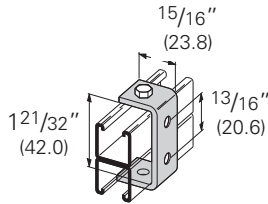

B6526 Two Hole Offset Z-Support

- Standard finishes: ZN, GRN
- Wt./C 5 Lbs. (2.2 kg)

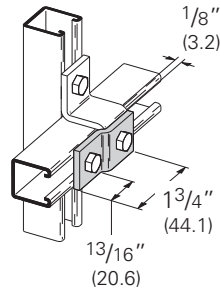

B6105 Two Hole Offset Z-Support for B62

- Standard finishes: ZN, GRN
- Wt./C 7 Lbs. (3.2 kg)

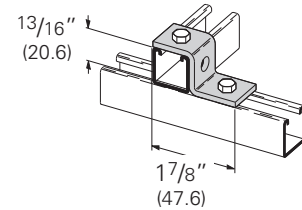

B7105 Two Hole Offset Z-Support for B72

- Standard finishes: ZN, GRN
- Wt./C 7 Lbs. (3.2 kg)

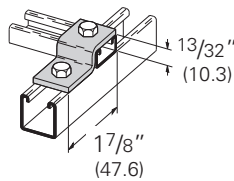

B6110 Two Hole Offset Z-Support for B62A

- Standard finishes: ZN, GRN
- Wt./C 9 Lbs. (4.1 kg)

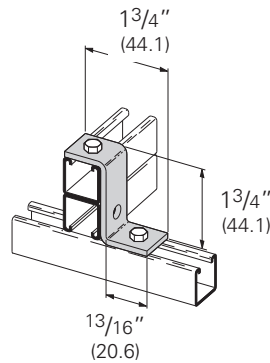

B6108 Two Hole Offset Z-Support

- Standard finishes: ZN, GRN
- Wt./C 7 Lbs. (3.2 kg)

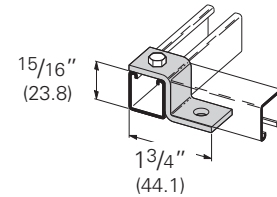

B598-62 Two Hole Z-Adapter Plate

- Standard finishes: ZN, GRN
- Wt./C 28 Lbs. (12.7 kg)

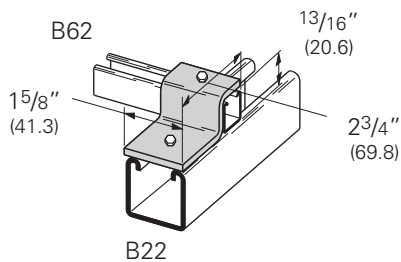

B6571 eight Hole Wing Connection

- Standard finishes: ZN, GRN
- Wt./C 28 Lbs. (12.7 kg)

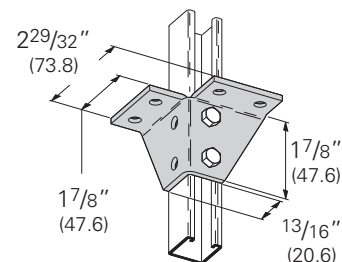

Reference page 201 for general fitting specifications.

B6205 End Cap for B62

- Material: ASTM A1008 SS Gr. 33 Type 1
- Standard finishes: ZN, GRN
- Wt./C 3 Lbs. (1.3 kg)

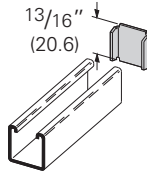

B7205 End Cap for B72

- Material: ASTM A1008 SS Gr. 33 Type 1
- Standard finishes: ZN, GRN
- Wt./C 1 Lb. (.4 kg)

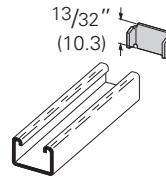

B6211 Z-Beam Clamp

- 5/16"-18 Setscrew included
- 13/16" (20.6) Max. Flange Thickness
- Material: ASTM A36
- Standard finishes: ZN, GRN
- Wt./C 13 Lbs. (5.9 kg)

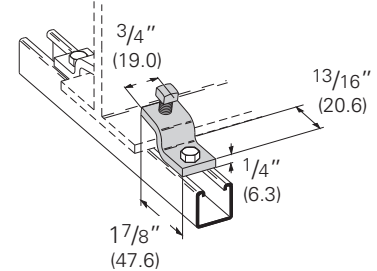

B6409-6, 9 Bracket

- Safety Factor of 2
- Uniform Design Load 40 Lbs. (.18 kN)
- Standard finishes: ZN, GRN

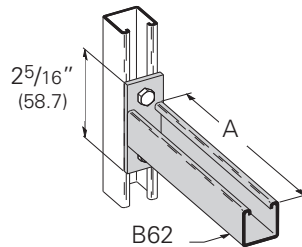

Part No.	A		Wt./C	
	In.	mm	Lbs.	kg
B6409-6	6"	(152.4)	28.0	(12.7)
B6409-9	9"	(228.6)	35.0	(15.8)

B2350-B2355 One Hole Double Tubing Strap

- Material: ASTM A1008 SS Gr. 33 Type 1
- Standard finishes: ZN, GRN

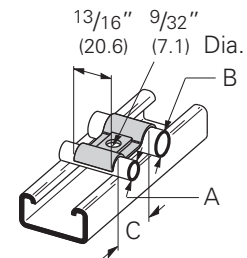

Part No.	O.D. Size A		O.D. Size B		C		Wt./C	
	In.	mm	In.	mm	In.	mm	Lbs.	kg
B2350	1/4"	(6.3)	1/4"	(6.3)	3/4"	(19.0)	1.2	(.5)
B2351	3/8"	(9.5)	3/8"	(9.5)	1"	(25.4)	2.0	(.9)
B2352	1/2"	(12.7)	1/2"	(12.7)	1 1/4"	(31.7)	2.9	(1.3)
B2353	1/4"	(6.3)	3/8"	(9.5)	7/8"	(22.2)	1.6	(.7)
B2354	1/4"	(6.3)	1/2"	(12.7)	1"	(25.4)	2.1	(.9)
B2355	3/8"	(9.5)	1/2"	(12.7)	1 1/8"	(28.6)	2.5	(1.1)

B2308-B2315 One Hole Tubing Strap

- Material: Sizes 1/4" - 1/2", ASTM A611 Gr. C
5/8" - 1", ASTM A1008 SS Gr. 33 Type 1
- Standard finishes: ZN, GRN

Part No.	O.D. Size A		B		C		Wt./C	
	In.	mm	In.	mm	In.	mm	Lbs.	kg
B2308	1/4"	(6.3)	1 1/32"	(26.2)	.048	(1.2)	1.2	(.5)
B2309	5/16"	(7.9)	1 3/32"	(27.8)	.048	(1.2)	1.4	(.6)
B2310	3/8"	(9.5)	1 3/16"	(30.1)	.048	(1.2)	1.6	(.7)
B2311	1/2"	(12.7)	1 21/64"	(33.7)	.048	(1.2)	1.9	(.8)
B2312	5/8"	(15.9)	1 25/64"	(35.3)	.062	(1.6)	2.7	(1.2)
B2313	3/4"	(19.0)	1 39/64"	(40.9)	.075	(1.9)	4.3	(1.9)
B2314	7/8"	(22.2)	1 51/64"	(45.6)	.075	(1.9)	4.9	(2.2)
B2315	1"	(25.4)	2 1/32"	(51.6)	.075	(1.9)	5.2	(2.3)

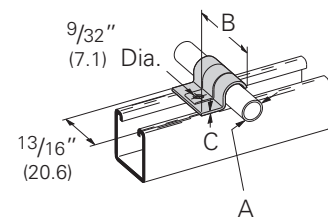

Reference page 201 for general fitting specifications.