

# Pow-R-Stock<sup>Plus</sup> quick selector reference guide

Frequently used distribution  
and control products available  
from distributor stock



**EATON**

*Powering Business Worldwide*

## Table of contents



## Pow-R-Stock panelboards

Questions to ask .....	5
Catalog numbering .....	6
Interiors, EZ Boxes and EZ Trims.....	8
Branch circuit breakers .....	10
Universal main circuit breaker kits— top or bottom mounting .....	11
Lug kits and accessories .....	13



## Safety switches/ disconnects

Questions to ask .....	14
Catalog numbering .....	15
General-duty safety switches .....	16
Heavy-duty safety switches .....	17
Safety switch kits .....	18



## Transformers

Questions to ask .....	19
Catalog numbering .....	20
General-purpose transformers.....	22
Sizing tables .....	24



## Enclosed control

Questions to ask .....	25
Catalog numbering .....	26
NEMA non-combination, non-reversing starters, Type 1 .....	26
NEMA combination, non-reversing starters, non-fusible disconnect, Type 1 ....	26
NEMA accessories.....	27
Lighting contactors.....	28



## Pushbutton stations and pushbuttons

Questions to ask .....	29
30 mm pushbutton stations .....	30
22 mm pushbutton stations .....	30
Individually packaged 30 mm pushbuttons and operators.....	31



# Manual starters

- Questions to ask ..... 32
- Manual motor switches without overload ..... 33
- Single-phase manual starter with overload protection ..... 33
- Single- and three-phase manual starters with  
overload protection ..... 33

# Questions to ask

## Step

1

Select an interior

**Q** What is your voltage?

**A** — 120/240 V single-phase, three-wire  
— 208Y/120 V three-phase, four-wire  
— 480Y/277 V three-phase, four-wire

**Q** What is your busbar rating?

**A** — 100 A (aluminum or copper)  
— 225 A (aluminum or copper)  
— 400 A (aluminum or copper)  
— 600 A (aluminum or copper)

**Q** What is the number of branch circuits/poles?

**A** — 18  
— 30  
— 42

## Step

2

Enclosure type

**Q** What enclosure is required?

**A** — NEMA® 1 indoor  
— NEMA 3R outdoor

## Step

3

Trim type

**Q** For NEMA 1 indoor panels, will the panel be mounted recessed in the wall or mounted directly to the wall?

**A** — Flush  
— Surface

## Step

4

**Q** What is the cable entry locations for the incoming feeder?

**A** — Top  
— Bottom

## Step

5

Main device

**Q** Main lugs only (MLO) or main circuit breaker?

**A** — MLO  
— MCB (choose amperage and top or bottom)

# Pow-R-Stock panelboards (unassembled)

## Catalog numbering system— Pow-R-Stock panelboard interiors

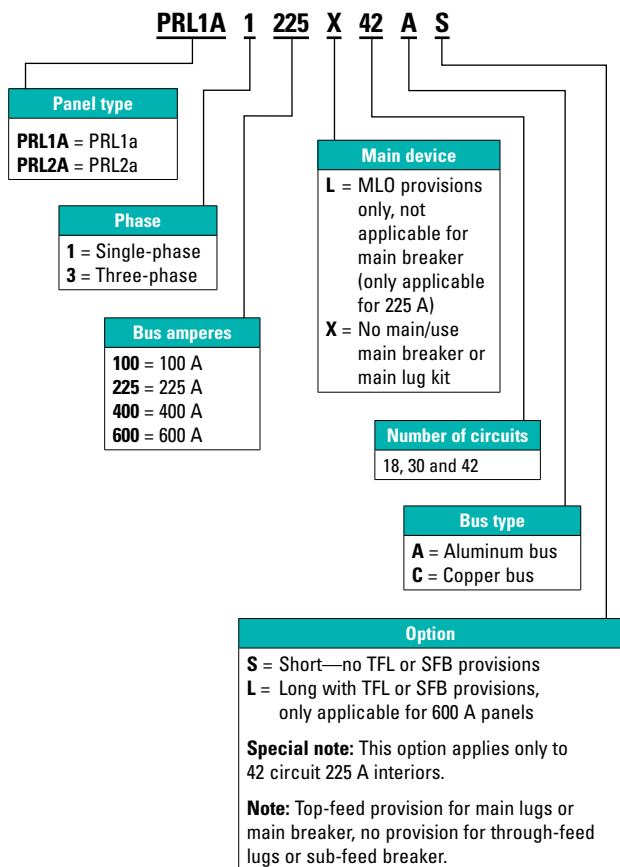

## Catalog numbering system— EZ Panel factory-assembled stock panelboards

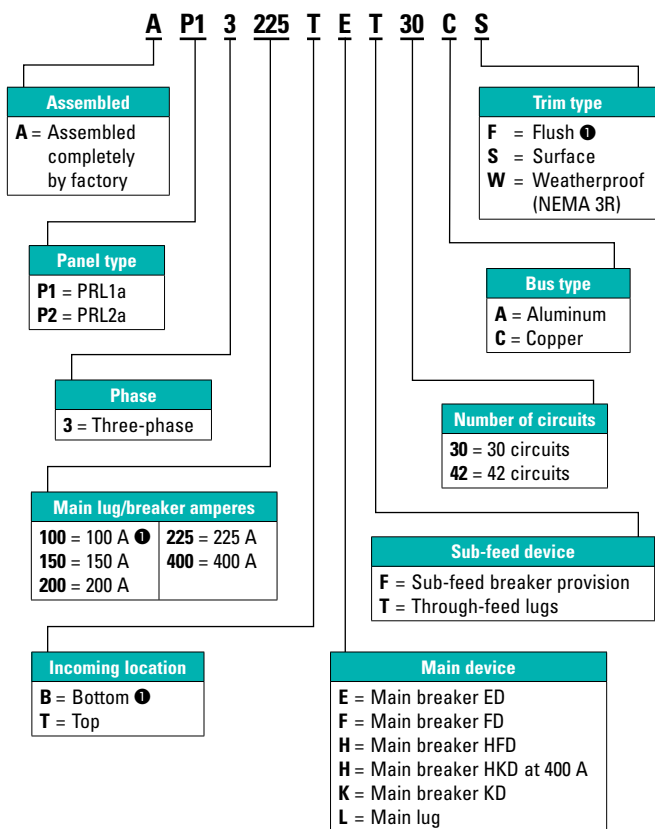

❶ These items are not part of the initial launch. Please consult VISTA or your Eaton sales engineer for product availability.

**Notes:** Not all combinations may be valid. Please verify availability of catalog number created. Refer to PA014007EN for more information on the EZ Panel.

## Pow-R-Stock panelboards—EZ™ Boxes and EZ Trims

Ampere rating	Max. number of poles	Capability				Catalog numbers	
		Main lugs	Main breaker	Through-feed lugs	Sub-feed breaker (225 A max.)	Interiors (less main device)	Aluminum bus
<b>Single-phase, three-wire 120/240 Vac</b>							
100	18	■	■	■	N/A		PRL1A1100X18A
100	30	■	■	■	100		PRL1A1100X30A
100	42	■	■	■	N/A		PRL1A1100X42A
225	30	■	■	■	100, 125, 150, 175, 200, 225		PRL1A1225X30A
225	42	■	■	N/A	N/A		PRL1A1225X42AS ①
225	42	■	■	■	100, 125, 150, 175, 200, 225		PRL1A1225X42A
400	42	■	■	N/A	N/A		PRL1A1400X42AS ①
400	42	■	■	■	100, 125, 150, 175, 200, 225		PRL1A1400X42A
600	42	■	■	■	N/A		
600	42	■	■	■	100, 125, 150, 175, 200, 225, 250, 300, 350, 400		
<b>Three-phase, four-wire 208Y/120 Vac</b>							
100	18	■	■	■	N/A		PRL1A3100X18A
100	30	■	■	■	100		PRL1A3100X30A
100	42	■	■	■	N/A		PRL1A3100X42A
225	30	■	■	■	100, 125, 150, 175, 200, 225		PRL1A3225X30A
225	42	■	N/A	N/A	N/A		PRL1A3225L42AS ①
225	42	■	■	N/A	N/A		PRL1A3225X42AS ①
225	42	■	■	■	100, 125, 150, 175, 200, 225		PRL1A3225X42A
400	42	■	■	N/A	N/A		PRL1A3400X42AS ①
400	42	■	■	■	100, 125, 150, 175, 200, 225		PRL1A3400X42A
600	42	■	■	■	N/A		
600	42	■	■	■	100, 125, 150, 175, 200, 225, 250, 300, 350, 400		
<b>Three-phase, four-wire 480Y/277 Vac</b>							
100	18	■	■	■	N/A		PRL2A3100X18A
100	30	■	■	■	100		PRL2A3100X30A
100	42	■	■	■	N/A		PRL2A3100X42A
225	30	■	■	■	100, 125, 150, 175, 200, 225		PRL2A3225X30A
225	42	■	N/A	N/A	N/A		PRL2A3225L42AS ①
225	42	■	■	N/A	N/A		PRL2A3225X42AS ①
225	42	■	■	■	100, 125, 150, 175, 200, 225		PRL2A3225X42A
400	42	■	■	N/A	N/A		PRL2A3400X42AS ①
400	42	■	■	■	100, 125, 150, 175, 200, 225		PRL2A3400X42A
600	42	■	■	■	N/A		
600	42	■	■	■	100, 125, 150, 175, 200, 225, 250, 300, 350, 400		

① S = Short—no TFL or SFB provisions.



Copper bus	Boxes	Trims (NEMA 1)		NEMA 3R enclosures
	NEMA 1	Surface	Flush	
PRL1A1100X18C	EZB2036R	EZT2036S	EZT2036F	GWPBQ2036PR
PRL1A1100X30C	EZB2048R	EZT2048S	EZT2048F	GWPBQ2048PR
PRL1A1100X42C	EZB2048R	EZT2048S	EZT2048F	GWPBQ2048PR
PRL1A1225X30C	EZB2048R	EZT2048S	EZT2048F	GWPBQ2048PR
PRL1A1225X42CS ①	EZB2048R	EZT2048S	EZT2048F	GWPBQ2048PR
PRL1A1225X42C	EZB2060R	EZT2060S	EZT2060F	GWPBQ2060PR
PRL1A1400X42CS ①	EZB2060R	EZT2060S	EZT2060F	GWPBQ2060PR
PRL1A1400X42C	EZB2072R	EZT2072S	EZT2072F	GWPBQ2072PR
PRL1A1600X42C	EZB2072R	EZT2072S	EZT2072F	GWPBQ2072PR
PRL1A1600X42CL	EZB2090R	EZT2090S	EZT2090F	GWPBQ2090PR
PRL1A3100X18C	EZB2036R	EZT2036S	EZT2036F	GWPBQ2036PR
PRL1A3100X30C	EZB2048R	EZT2048S	EZT2048F	GWPBQ2048PR
PRL1A3100X42C	EZB2048R	EZT2048S	EZT2048F	GWPBQ2048PR
PRL1A3225X30C	EZB2048R	EZT2048S	EZT2048F	GWPBQ2048PR
PRL1A3225L42CS ①	EZB2042R	EZT2042S	EZT2042F	GWPBQ2042PR
PRL1A3225X42CS ①	EZB2048R	EZT2048S	EZT2048F	GWPBQ2048PR
PRL1A3225X42C	EZB2060R	EZT2060S	EZT2060F	GWPBQ2060PR
PRL1A3400X42CS ①	EZB2060R	EZT2060S	EZT2060F	GWPBQ2060PR
PRL1A3400X42C	EZB2072R	EZT2072S	EZT2072F	GWPBQ2072PR
PRL1A3600X42C	EZB2072R	EZT2072S	EZT2072F	GWPBQ2072PR
PRL1A3600X42CL	EZB2090R	EZT2090S	EZT2090F	GWPBQ2090PR
PRL2A3100X18C	EZB2036R	EZT2036S	EZT2036F	GWPBQ2036PR
PRL2A3100X30C	EZB2048R	EZT2048S	EZT2048F	GWPBQ2048PR
PRL2A3100X42C	EZB2048R	EZT2048S	EZT2048F	GWPBQ2048PR
PRL2A3225X30C	EZB2048R	EZT2048S	EZT2048F	GWPBQ2048PR
PRL2A3225L42CS ①	EZB2042R	EZT2042S	EZT2042F	GWPBQ2042PR
PRL2A3225X42CS ①	EZB2048R	EZT2048S	EZT2048F	GWPBQ2048PR
PRL2A3225X42C	EZB2060R	EZT2060S	EZT2060F	GWPBQ2060PR
PRL2A3400X42CS ①	EZB2060R	EZT2060S	EZT2060F	GWPBQ2060PR
PRL2A3400X42C	EZB2072R	EZT2072S	EZT2072F	GWPBQ2072PR
PRL2A3600X42C	EZB2072R	EZT2072S	EZT2072F	GWPBQ2072PR
PRL2A3600X42CL	EZB2090R	EZT2090S	EZT2090F	GWPBQ2090PR

**Note:** The colors shown in the tables correspond to the color coding on the trim, interior and box product packaging labels. Be sure that all three parts match when delivering to your customer.

**Note:** Distributors can purchase boxes in quantities via the Distributor toolbox.

## Branch circuit breakers

Summary of branch breakers available

Breaker	No. of poles	Ampere rating	Voltage	kAIC rating	Example	Panel type
BAB ①②	1	15–70	120	10	<b>BAB1020</b>	PRL1a
	2	15–100	120/240	10	<b>BAB2020</b>	PRL1a
	2	15–100	240	10	<b>BAB2040H</b>	PRL1a
	3	15–100	240	10	<b>BAB3030H</b>	PRL1a
QBAF	1	15–20	120	10	<b>QBAF1020</b>	PRL1a
QBHAF	1	15–20	120	22	<b>QBHAF1020</b>	PRL1a
QBCAF	1	15–20	120	10	<b>QBCAF1020</b>	PRL1a
QBHCAF	1	15–20	120	22	<b>QBHCAF1020</b>	PRL1a
QBGFT	1	15–40	120	10	<b>QBGFT1020</b>	PRL1a
	2	15–50	120/240	10	<b>QBGFT2040</b>	PRL1a
QBHGFT	1	15–30	120	22	<b>QBHGFT1020</b>	PRL1a
	2	15–30	120/240	22	<b>QBHGFT2020</b>	PRL1a
QBGFEP	1	15–40	120	10	<b>QBGFEP1020</b>	PRL1a
	2	15–50	120/240	10	<b>QBGFEP2020</b>	PRL1a
QBHGFEF	1	15–30	120	22	<b>QBHGFEF1020</b>	PRL1a
	2	15–30	120/240	22	<b>QBHGFEF2020</b>	PRL1a
QBHW ①	1	15–70	120	22	<b>QBHW1020</b>	PRL1a
	2	15–100	120/240	22	<b>QBHW2020</b>	PRL1a
	2	15–100	240	22	<b>QBHW2040H</b>	PRL1a
	3	15–100	240	22	<b>QBHW3030H</b>	PRL1a
GHQ ①	1	15–20	277	14	<b>GHQ1020</b>	PRL2a
GHB ①②	1	15–100	277	14	<b>GHB1020</b>	PRL2a
	2	15–100	480Y/277	14	<b>GHB2040</b>	PRL2a
	3	15–100	480Y/277	14	<b>GHB3060</b>	PRL2a

① BAB, QBHW, GHQ and GHB breakers installed in PRL1a and PRL2a are available with shunt trip, i.e., BAB1020S.

② BAB-H and GHB 50–100 A available as chassis-mounted main device.

## Universal main circuit breaker kits— top or bottom mounting

### Kits—main circuit breaker (includes circuit breaker and terminals)

Max. volt.	Ampere rating	Service	Breaker frame	Mounting location	Wire range Al/Cu (in kcmil)	Catalog number
240 Vac	100	Single- or three-phase	ED	Universal	(1) #14–1/0	<b>BKED100</b>
	125	Single- or three-phase	ED	Universal	(1) #4–4/0	<b>BKED125</b>
	150	Single- or three-phase	ED	Universal	(1) #4–4/0	<b>BKED150</b>
	175	Single- or three-phase	ED	Universal	(1) #4–4/0 ①	<b>BKED175</b>
	200	Single- or three-phase	ED	Universal	(1) #4–4/0 ①	<b>BKED200</b>
	225	Single- or three-phase	ED	Universal	(1) #4–4/0 ①	<b>BKED225</b>
480 Vac	100	Single- or three-phase	FD	Universal	(1) #14–1/0	<b>BKFD100</b>
	110	Single- or three-phase	FD	Universal	(1) #4–4/0	<b>BKFD110</b>
	125	Single- or three-phase	FD	Universal	(1) #4–4/0	<b>BKFD125</b>
	150	Single- or three-phase	FD	Universal	(1) #4–4/0	<b>BKFD150</b>
	175	Single- or three-phase	FD	Universal	(1) #4–4/0 ①	<b>BKFD175</b>
	200	Single- or three-phase	FD	Universal	(1) #4–4/0 ①	<b>BKFD200</b>
	225	Single- or three-phase	FD	Universal	(1) #4–4/0 ①	<b>BKFD225</b>
480 Vac	100	Single- or three-phase	HFD	Universal	(1) #14–1/0	<b>BKHFD100</b>
	110	Single- or three-phase	HFD	Universal	(2) #4–4/0	<b>BKHFD110</b>
	125	Single- or three-phase	HFD	Universal	(2) #4–4/0	<b>BKHFD125</b>
	150	Single- or three-phase	HFD	Universal	(2) #4–4/0	<b>BKHFD150</b>
	175	Single- or three-phase	HFD	Universal	(2) #4–4/0	<b>BKHFD175</b>
	200	Single- or three-phase	HFD	Universal	(2) #4–4/0	<b>BKHFD200</b>
	225	Single- or three-phase	HFD	Universal	(2) #4–4/0	<b>BKHFD225</b>
480 Vac	250	Single- or three-phase	KD	Universal	(1) 250–500	<b>BKKD250</b>
	300	Single- or three-phase	KD	Universal	(1) 250–500	<b>BKKD300</b>
	350	Single- or three-phase	KD	Universal	(1) 250–500	<b>BKKD350</b>
	400	Single- or three-phase	KD	Universal	(2) 3/0–250 or (1) 3/0–500	<b>BKKD400</b>

① Order optional lug kit catalog no. 3TA225FDK for 175–225 A ED- and FD-Frame three-pole circuit breakers to provide terminations for (1) #6–300 kcmil.

**Note:** KD kits are to be used on 400 A and 600 A panels only.

## Universal main circuit breaker kits— top or bottom mounting

### Kits—main circuit breaker (includes circuit breaker and terminals)

Max. volt.	Ampere rating	Service	Breaker frame	Mounting location	Wire range Al/Cu (in kcmil)	Catalog number
480 Vac	250	Single- or three-phase	HKD	Universal	(1) 250–500	<b>BKHKD250</b>
	300	Single- or three-phase	HKD	Universal	(1) 250–500	<b>BKHKD300</b>
	350	Single- or three-phase	HKD	Universal	(1) 250–500	<b>BKHKD350</b>
	400	Single- or three-phase	HKD	Universal	(1) 250–500	<b>BKHKD400</b>
480 Vac	400	Single- or three-phase	LG	Universal	(1) #2–500	<b>BKLGE400</b>
	500	Single- or three-phase	LG	Universal	(2) #2–500	<b>BKLGE500</b>
	600	Single- or three-phase	LG	Universal	(2) #2–500	<b>BKLGE600</b>

## Lug kits and accessories

### Standard main/sub-feed breaker lug capacities

Ampere rating	Lug wire range Al/Cu
100	(1) #14–1/0
125–225	(1) #4–4/0
250–350	(1) 250–500 kcmil
400	(2) 3/0–250 kcmil or (1) 3/0–500 kcmil

### Main/through-feed lug kits

Ampere rating	Wire range Al/Cu	Catalog number
100	(1) #14–1/0	<b>LUGKIT100</b>
225	(1) #6–300 kcmil	<b>LUGKIT225</b>
400	(2) #2–500 kcmil	<b>LUGKIT400</b>
600	(2) #2–500 kcmil	<b>LUGKIT600</b>

### Kits

Description	Catalog number		
	100 A	225 A	400/600 A
Service entrance kit—MLO	<b>SEK1/2 ①</b>	<b>SEK1/2 ①</b>	<b>SEK4/6 ①</b>
Service entrance kit—MCB	<b>SEKB ②④</b> <b>SEKG ③④</b>	<b>SEKF ④⑤</b>	<b>SEKKL ④⑥</b>
200% neutral kit	<b>2NK100</b>	<b>2NK225</b>	<b>1NK400</b>
Sub-feed breaker adapter (used to mount 225 A sub-feed breaker in 400 A panels)	—	—	<b>225ASFBKIT</b>
Sub-feed breaker adapter (used to mount 225 A sub-feed breaker in 600 A panels)	—	—	<b>225BSFBKIT</b>
Sub-feed breaker adapter (used to mount 400 A sub-feed breaker in 600 A panels)	—	—	<b>400ASFBKIT</b>

① Applicable for use with MLO, SE panels only.

② Only applicable for SE PRL1a with chassis-mounted BAB, QBH main breaker.

③ Only applicable for SE PRL2a with chassis-mounted GHB main breaker.

④ Main breaker panels only—includes barrier kit and bonding jumper.

⑤ To be used with F-frame main breaker.

⑥ To be used with K- and L-frame main breaker.

### Accessories

Description	Catalog number
Isolated ground bar kit	<b>ISOGROUND</b>
Copper ground bar kit	<b>CUGROUND</b>
1P filler plate ①	<b>5155C62H01</b>
Series rating kit ②	<b>SRK</b>

① Each PRS panel comes with 50% filler plates, e.g., 18 circuit interior contains 9 filler plates.

② Series rating kit includes series rating book and adhesive sleeve and series rating sticker. If panelboard is being series rated higher than the base rating, an SRK is required.

# Questions to ask

## Step 1

1

**Q** Which type of switch do you need?

- A**
- Heavy-duty (DH)
  - General-duty (DG)
  - Double-throw (DT)

## Step 2

2

**Q** What current (ampere) rating do you need?

- A**
- 30, 60, 100, 200, 400, 600, 800, 1200

## Step 3

3

**Q** Should it be fused, non-fused or fusible with neutral?

- A**
- F = Fusible without neutral
  - U = Non-fusible
  - N = Fusible with neutral

## Step 4

4

**Q** How many poles?

- A**
- 1, 2, 3, 4, 6

## Step 5

5

**Q** Choose the maximum circuit voltage.

- A**
- 240 Vac
  - 600 Vac

## Step 6

6

**Q** What type of enclosure do you need?

- A**
- NEMA 1
  - NEMA 3R
  - NEMA 12
  - NEMA 4 painted steel
  - NEMA 4X stainless steel
  - NEMA 4X non-metallic

# Safety switches/ disconnects

## Catalog numbering system—safety switches

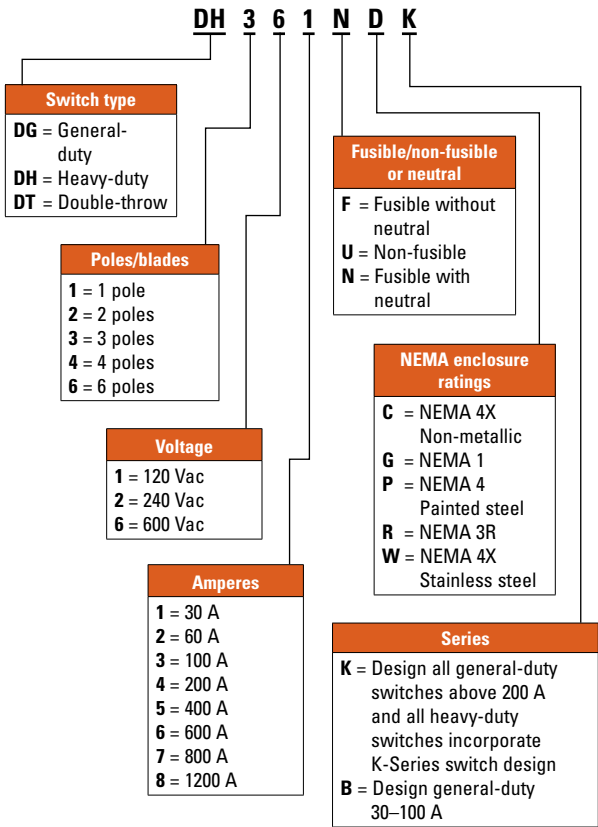

## General-duty safety switches (disconnects)

**Two-pole—240 Vac (suitable for service entrance use with a neutral or ground kit)**

Current rating (amps)	Type	Enclosure type	Max. hp ratings		Catalog number
			Single-phase		
			120 Vac	240 Vac	
30	Fusible with neutral	NEMA 1		1.5–3	DG221NGB
30	Non-fusible	NEMA 1	2	3	DG221UGB
30	Fusible with neutral	NEMA 3R		1.5–3	DG221NRB
30	Non-fusible	NEMA 3R	2	3	DG221URB
60	Fusible with neutral	NEMA 1		3–10	DG222NGB
60	Non-fusible	NEMA 1	3	10	DG222UGB
60	Fusible with neutral	NEMA 3R		3–10	DG222NRB
60	Non-fusible	NEMA 3R	1	10	DG222URB
100	Fusible with neutral	NEMA 1		7.5–15	DG223NGB
100	Non-fusible	NEMA 1		15	DG223UGB
100	Fusible with neutral	NEMA 3R		7.5–15	DG223NRB
100	Non-fusible	NEMA 3R		15	DG223URB

**Three-pole—240 Vac (suitable for service entrance use with a neutral or ground lug kit)**

Current rating (amps)	Type	Enclosure type	Max. hp ratings ①		Catalog number
			Single-phase	Three-phase	
			240 Vac	240 Vac	
30	Fusible with neutral	NEMA 1	1.5–3	3–7.5	DG321NGB
30	Non-fusible	NEMA 1	3	7.5	DG321UGB
30	Fusible with neutral	NEMA 3R	1.5–3	3–7.5	DG321NRB
30	Non-fusible	NEMA 3R	3	7.5	DG321URB
60	Fusible with neutral	NEMA 1	3–10	7.5–15	DG322NGB
60	Non-fusible	NEMA 1	10	15	DG322UGB
60	Fusible with neutral	NEMA 3R	3–10	7.5–15	DG322NRB
60	Non-fusible	NEMA 3R	10	15	DG322URB
100	Fusible with neutral	NEMA 1	7.5–15	15–30	DG323NGB
100	Non-fusible	NEMA 1	15	30	DG323UGB
100	Fusible with neutral	NEMA 3R	7.5–15	15–30	DG323NRB
100	Non-fusible	NEMA 3R	15	30	DG323URB

① Maximum hp ratings for fusible units apply only when dual element time-delay fuses are used.

### Neutral and ground lug kits

Description	Catalog number
Neutral kit for 30 A switches	DG030NB
Neutral kit for 60–100 A switches	DG100NB
Ground lug kit for 30–100 A switches	DG030GB

### Class R fuse adapter kits

Ampere rating	Type	Voltage	Catalog number
30	General-duty	240	DG30RB
60	General-duty	240	DS16FK
100	General-duty	240	DG100RB



## Heavy-duty safety switches (disconnects)

**Three-pole—480–600 Vac (suitable for service entrance use with a neutral or ground lug kit below)**

Current rating (amps)	Type	Enclosure type	Max. hp ratings				Catalog number
			Single-phase		Three-phase		
			480 V	600 V	480 V	600 V	
30	Fusible	NEMA 1	7.5	15	10	20	<b>DH361FGK ❶</b>
30	Non-fusible	NEMA 1	7.5	15	10	20	<b>DH361UGK</b>
30	Fusible	NEMA 3R	7.5	15	10	20	<b>DH361FRK ❶</b>
30	Non-fusible	NEMA 3R	7.5	15	10	20	<b>DH361URK</b>
30	Fusible	NEMA 4X	7.5	10	15	20	<b>DH361FWK ❶</b>
30	Non-fusible	NEMA 4X	7.5	10	20	30	<b>DH361UWK</b>
60	Fusible	NEMA 1	20	30	25	50	<b>DH362FGK</b>
60	Non-fusible	NEMA 1	20	30	25	50	<b>DH362UGK</b>
60	Fusible	NEMA 3R	20	30	25	50	<b>DH362FRK</b>
60	Non-fusible	NEMA 3R	20	30	25	50	<b>DH362URK</b>
60	Fusible	NEMA 4X	20	25	30	50	<b>DH362FWK</b>
60	Non-fusible	NEMA 4X	20	25	50	60	<b>DH362UWK</b>
100	Fusible	NEMA 1	30	60	40	75	<b>DH363FGK</b>
100	Non-fusible	NEMA 1	30	60	40	75	<b>DH363UGK</b>
100	Fusible	NEMA 3R	30	60	40	75	<b>DH363FRK</b>
100	Non-fusible	NEMA 3R	30	60	40	75	<b>DH363URK</b>
100	Fusible	NEMA 4X	30	40	60	75	<b>DH363FWK</b>
100	Non-fusible	NEMA 4X	40	50	75	100	<b>DH363UWK</b>
200	Fusible	NEMA 1	50	125	50	150	<b>DH364FGK</b>
200	Non-fusible	NEMA 1	50	125	50	150	<b>DH364UGK</b>
200	Fusible	NEMA 3R	50	125	50	150	<b>DH364FRK</b>
200	Non-fusible	NEMA 3R	50	125	50	150	<b>DH364URK</b>
200	Fusible	NEMA 4X	50	50	125	150	<b>DH364FWK</b>
200	Non-fusible	NEMA 4X	50	50	125	125	<b>DH364UWK</b>

❶ For 30 A switches requiring Class J fusing, switch must be ordered with the Class J clips from the factory by adding a suffix "J" on the end.

## Safety switch kits

### Neutral and ground lug kits ①

Description	Catalog number
Neutral kit for 30–60 A switches	DH030NK
Neutral kit for 100 A switches	DH100NK
Neutral kit for 200 A switches	DG200NK
Ground lug kit for 30–100 A switches	DS100GK
Ground lug kit for 200 A switches	DS200GK

① A factory-installed ground lug is supplied on all NEMA 4, 4X and 12 safety switches, as well as all 400 A and higher NEMA 1 and 3R safety switches. A factory-installed ground lug is also supplied on all heavy-duty NEMA 1 and 3R 30–200 A switches that do not have a factory installed neutral.

### Class R fuse adapter kits

Ampere rating	Type	Voltage	Catalog number
30	Heavy-duty	600	DS16FK
60	Heavy-duty	600	DS26FK
100	Heavy-duty	600	DS36FK
200	Heavy-duty	600	DS346FK

### Class J fuse adapter kit ①

Ampere rating	Type	Voltage	Catalog number
60	Heavy-duty	600	DS26JK

① 30 A switches must be ordered from the factory with Class J fuse provisions by adding suffix “J” at the end of the switch catalog number. 100 A and 200 A switches can be field modified by moving the load side fuse base.

# Questions to ask

## Step 1

1

**Q** How many phases?

**A** — Single-phase  
— Three-phase

## Step 2

2

**Q** What type of enclosure is required?

**A** — Ventilated  
— Encapsulated

## Step 3

3

**Q** What is the primary voltage? (input voltage)

**A** — Single-phase is 240 V x 480 V  
— Three-phase is 480 V delta (three-phase, three-wire)

## Step 4

4

**Q** What is the secondary voltage? (output voltage)

**A** — Single-phase  
— 120/240  
  
— Three-phase  
— 208Y/120 (three-phase, four-wire) or 240 V delta

## Step 5

5

**Q** What kVA transformer is required?

**A** — If single-phase encapsulated, kVAs are:  
0.05, 0.075, 0.1, 0.15, 0.25, 0.5, 0.75, 1,  
1.5, 2, 3, 5, 7.5, 10, 15, 25, 37.5  
— If single-phase ventilated, kVAs are:  
15, 25, 37.5, 50, 75, 100, 167  
— If three-phase encapsulated, kVAs are:  
3, 6, 9, 15, 30, 45, 75  
— If three-phase ventilated, kVAs are:  
15, 30, 45, 75, 112.5, 150, 225, 300

## Step 6

6

**Q** If a ventilated transformer was selected

**A** — Field kits: lug kits or weathershields  
— Select from selection tables

# Transformers

# Catalog numbering system—DOE 2016 ventilated transformers

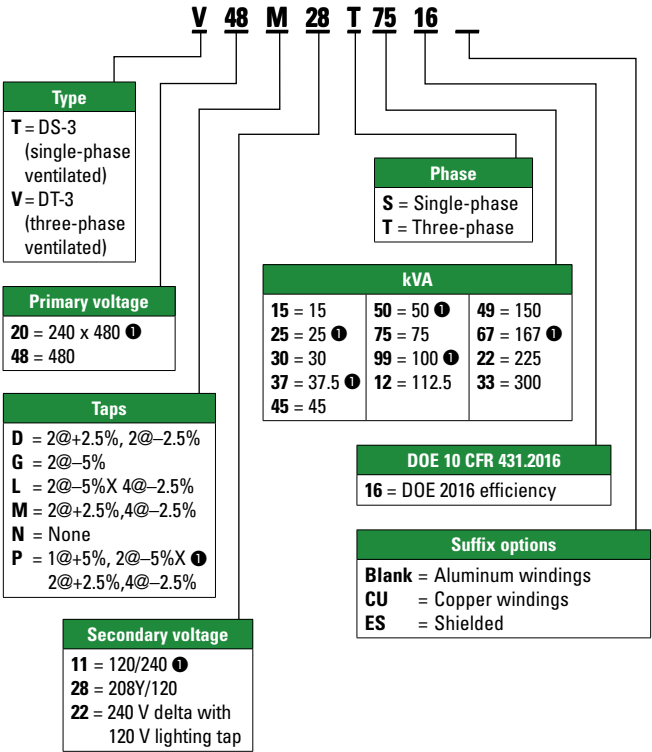

① Typically used with single-phase transformers.

## Catalog numbering system—encapsulated transformers

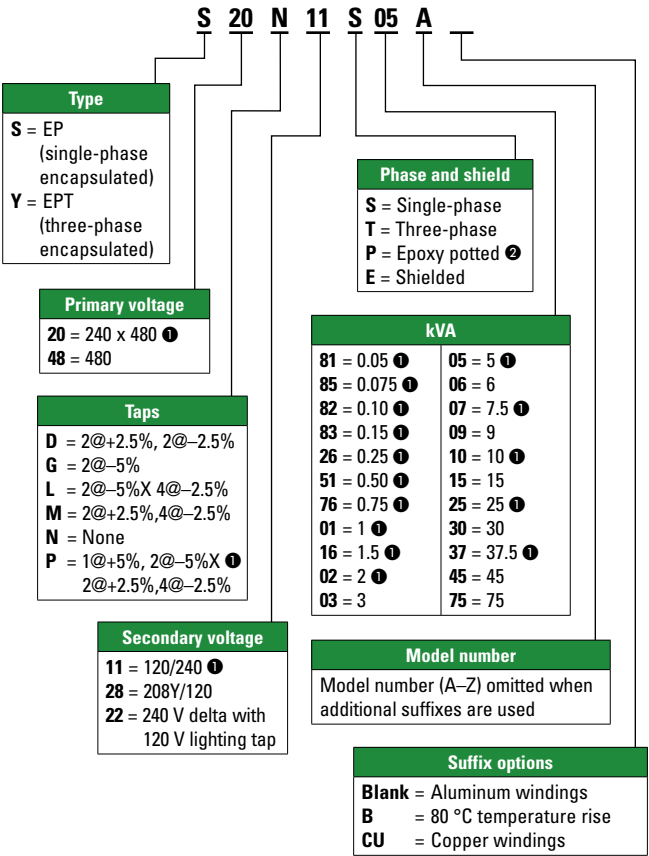

❶ Typically used with single-phase transformers.

❷ Single-phase 0.25–2 kVA encapsulated transformers only.

## General-purpose transformers

### Three-phase ventilated, 480 delta—208 Y/120, 150 °C rise, aluminum windings, DOE 2016

kVA	Frame number	Wiring diagram	Weathershield	Typical lug kit	Catalog number
15	939	280B	WS57	LKS1	V48M28T1516 ①
30	940	280B	WS58	LKS1	V48M28T3016 ①
45	940	280B	WS58	LKS1	V48M28T4516 ①
75	942	280B	WS59	LKS2	V48M28T7516 ②
112.5	943	280B	WS60	LKS2	V48M28T1216 ②
150	943	280B	WS60	LKS3	V48M28T4916 ②
225	944	280B	WS61	LKS3	V48M28T2216
300	945	280B	WS62	LKS3	V48M28T3316

① Suitable for use with wall-mounted bracket WMB05.

② Suitable for use with wall-mounted bracket WMB04.

### Three-phase ventilated, 480 delta—240/120 lighting tap, 150 °C rise, aluminum windings, DOE 2016

kVA	Frame number	Wiring diagram	Weathershield	Typical lug kit	Catalog number
15	939	282B	WS57	LKS1	V48M22T1516 ①
30	940	282B	WS58	LKS1	V48M22T3016 ①
45	940	282B	WS58	LKS1	V48M22T4516 ①
75	942	282B	WS59	LKS2	V48M22T7516 ②
112.5	943	282B	WS60	LKS2	V48M22T1216 ②
150	943	282B	WS60	LKS3	V48M22T4916 ②
225	944	282B	WS61	LKS3	V48M22T2216
300	945	282B	WS62	LKS3	V48M22T3316

① Suitable for use with wall-mounted bracket WMB05.

② Suitable for use with wall-mounted bracket WMB04.

### Three-phase encapsulated, 480 delta—208 Y/120, 115 °C rise

kVA	Frame number	Wiring diagram	Catalog number
3	201	70A	Y48G28T03N
6	200	70A	Y48G28T06N
9	103	70A	Y48G28T09N
15	95	72B	Y48D28T15N
30	243	84A	Y48M28T30N
45	244	84A	Y48M28T45N
75	245	84A	Y48M28T75N

**Note:** For frame drawings and wiring diagrams, refer to [www.eaton.com/transformers](http://www.eaton.com/transformers).

## General-purpose transformers

**Single-phase ventilated, 240 x 480–120/240, 150 °C rise, aluminum windings, DOE 2016**

kVA	Frame number	Wiring diagram	Weathershield	Typical lug kit	Catalog number
15	842	3XA	WS45	LKS1	<b>T20P11S1516 ①</b>
25	842	3XA	WS45	LKS1	<b>T20P11S2516 ①</b>
37.5	843	3XA	WS43	LKS1	<b>T20P11S3716</b>
50	843	3XA	WS43	LKS2	<b>T20P11S5016</b>
75	844	3XA	WS44	LKS2	<b>T20P11S7516</b>
100	844	3XA	WS44	LKS3	<b>T20P11S9916</b>
167	814	288A	WS13	LKS3	<b>T48P11S6716 ②</b>

① Suitable for use with wall-mounted bracket WMB01.

② 480 V primary only.

**Single-phase encapsulated 240 x 480–120/240, 115 °C rise**

kVA	Frame number	Wiring diagram	Catalog number
0.05	52	3A	<b>S20N11S81N</b>
0.075	53	3A	<b>S20N11S85N</b>
0.1	54	3A	<b>S20N11S82N</b>
0.15	55	3A	<b>S20N11S83N</b>
0.25	57P	3A	<b>S20N11P26P</b>
0.5	57P	3A	<b>S20N11P51P</b>
0.75	58P	3A	<b>S20N11P76P</b>
1	67P	3A	<b>S20N11P01P</b>
1.5	67P	3A	<b>S20N11P16P</b>
2	68P	3A	<b>S20N11P02P</b>
3	176	3A	<b>S20N11S03N</b>
5	177	3A	<b>S20N11S05N</b>
7.5	178	3A	<b>S20N11S07N</b>
10	179	3A	<b>S20N11S10N</b>
15	180	3A	<b>S20N11S15N</b>
25	182	23A	<b>S20L11S25N</b>
37.5	300A	248A	<b>S20L11S37</b>

**Note:** For frame drawings and wiring diagrams, refer to [www.eaton.com/transformers](http://www.eaton.com/transformers).

## General-purpose transformers sizing tables

### Three-phase transformer full load current

kVA	Rated line-line voltage						
	208	240	480	600	2400	4160	4800
3	8.3	7.2	3.6	2.9	0.7	0.4	0.4
6	16.7	14.4	7.2	5.8	1.4	0.8	0.7
9	25.0	21.7	10.8	8.7	2.2	1.2	1.1
15	41.6	36.1	18.0	14.4	3.6	2.1	1.8
30	83.3	72.2	36.1	28.9	7.2	4.2	3.6
45	124.9	108.3	54.1	43.3	10.8	6.2	5.4
75	208.2	180.4	90.2	72.2	18.0	10.4	9.0
112.5	312.3	270.6	135.3	108.3	27.1	15.6	13.5
150	416.4	360.9	180.4	144.3	36.1	20.8	18.0
225	624.6	541.3	270.6	216.5	54.1	31.2	27.1
300	832.7	721.7	360.9	288.7	72.2	41.6	36.1
500	1387.9	1202.8	601.4	481.1	120.3	69.4	60.1
750	2081.9	1804.3	902.1	721.7	180.4	104.1	90.2
1000	2775.8	2405.7	1202.8	962.3	240.6	138.8	120.3

**Note:** Line current = (kVA x 1000) / (line voltage x 1.732).

### Single-phase transformer full load current

kVA	Rated line-line voltage								
	120	208	240	277	480	600	2400	4160	4800
0.5	4.2	2.4	2.1	1.8	1.0	0.8	0.2	0.1	0.1
1	8.3	4.8	4.2	3.6	2.1	1.7	0.4	0.2	0.2
1.5	12.5	7.2	6.3	5.4	3.1	2.5	0.6	0.4	0.3
2	16.7	9.6	8.3	7.2	4.2	3.3	0.8	0.5	0.4
3	25.0	14.4	12.5	10.8	6.3	5.0	1.3	0.7	0.6
5	41.7	24.0	20.8	18.1	10.4	8.3	2.1	1.2	1.0
7.5	62.5	36.1	31.3	27.1	15.6	12.5	3.1	1.8	1.6
10	83.3	48.1	41.7	36.1	20.8	16.7	4.2	2.4	2.1
15	125.0	72.1	62.5	54.2	31.3	25.0	6.3	3.6	3.1
25	208.3	120.2	104.2	90.3	52.1	41.7	10.4	6.0	5.2
37.5	312.5	180.3	156.3	135.4	78.1	62.5	15.6	9.0	7.8
50	416.7	240.4	208.3	180.5	104.2	83.3	20.8	12.0	10.4
75	625.0	360.6	312.5	270.8	156.3	125.0	31.3	18.0	15.6
100	833.3	480.8	416.7	361.0	208.3	166.7	41.7	24.0	20.8
167	1391.7	802.9	695.8	602.9	347.9	278.3	69.6	40.1	34.8
250	2083.3	1201.9	1041.7	902.5	520.8	416.7	104.2	60.1	52.1
333	2775.0	1601.0	1387.5	1202.2	693.8	555.0	138.8	80.0	69.4

**Note:** Line current = (kVA x 1000) / line voltage.



# Questions to ask

## Step 1

1

**Q** What type of enclosure do you need?

- A**
- NEMA 1 (general-duty)
  - NEMA 3R (rain-tight)
  - NEMA 12 (dust-tight)
  - NEMA 4X (wash-down)

## Step 2

2

**Q** What type of starter do you need?

- A**
- NEMA non-combination
  - NEMA combination, non-fusible or fusible
  - NEMA combination, breaker
  - Lighting contactor

## Step 3

3

**Q** What is the horsepower and voltage of the motor?  
(Note: this will determine the NEMA starter size)

- A**
- Horsepower: 1, 5, 10, 25 hp etc.
  - Motor voltage: 200, 230, 460, 575 V

## Step 4

4

**Q** What is the control voltage for the coil?

- A**
- 120 Vac
  - 240 Vac
  - 480 Vac

## Step 5

5

**Q** What size overload relay is needed?

- A**
- 1–5 FLA
  - 4–20 FLA
  - 9–45 FLA

## Step 6

6

**Q** What additional accessories do you need?

- A**
- Cover control kits, such as HAND/OFF/AUTO selector switch or STOP/START pushbuttons
  - CPT kits
  - Fuse kits

# Enclosed control

## Catalog numbering system—non-combination and combination NEMA enclosed starters

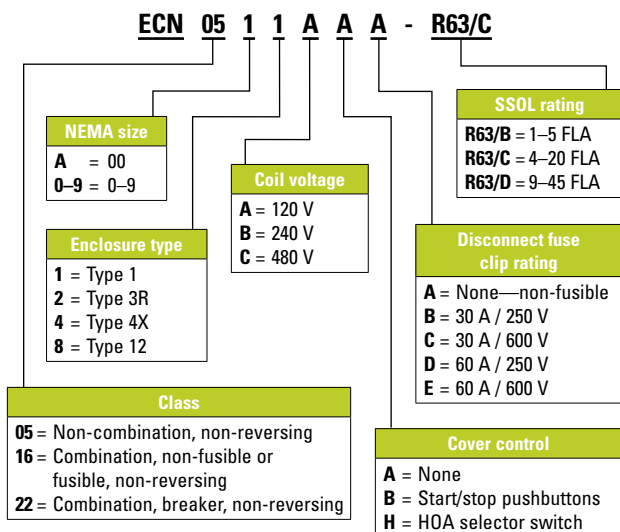

## Starters

### NEMA non-combination, non-reversing starters, Type 1

NEMA size	Motor voltage	Maximum hp rating	Magnet coil voltage	SSOL range	Catalog number
00	200, 230	1-1/2	120	1-5	ECN05A1AAA-R63/B
	460	2	120	1-5	ECN05A1AAA-R63/B
0	200, 230	3	120	1-5	ECN0501AAA-R63/B
	460	5	120	1-5	ECN0501AAA-R63/B
	200, 230	3	120	4-20	ECN0501AAA-R63/C
	460	5	120	4-20	ECN0501AAA-R63/C
1	200, 230	7-1/2	120	4-20	ECN0511AAA-R63/C
	460	10	120	4-20	ECN0511AAA-R63/C
2	200, 230	10	120	9-45	ECN0521AAA-R63/D
	460	25	120	9-45	ECN0521AAA-R63/D

### NEMA combination, non-reversing starters, non-fusible disconnect Type 1

NEMA size	Motor voltage	Maximum hp rating	Magnet coil voltage	SSOL range	Catalog number
00	200, 230	1-1/2	120	1-5	ECN16A1AAA-R63/B
	460	2	120	1-5	ECN16A1AAA-R63/B
0	200, 230	3	120	1-5	ECN1601AAA-R63/B
	460	5	120	1-5	ECN1601AAA-R63/B
	200, 230	3	120	4-20	ECN1601AAA-R63/C
	460	5	120	4-20	ECN1601AAA-R63/C
1	200, 230	7-1/2	120	4-20	ECN1611AAA-R63/C
	460	10	120	4-20	ECN1611AAA-R63/C
2	200, 230	10	120	9-45	ECN1621AAA-R63/D
	460	25	120	9-45	ECN1621AAA-R63/D

## Starters

### NEMA enclosures with CPT modifications

To order an enclosure with CPT:

1. Change ECN05 to ECN07 for non-combination units, and ECN16 to ECN18 for combination units.
2. Change the “A” in the 7th catalog string to the correct letter based on the below table:

<b>Catalog string letter</b>	<b>Primary</b>	<b>Secondary</b>
E	208/60	120/60
B	240/480–220/440 wired for 240 V	120/60–110/50
C	240/480–220/440 wired for 480 V	120/60–110/50

### NEMA accessories—CPT and fuse kits

<b>Description</b>	<b>Catalog number</b>
100 VA CPT kit (208/277 V primary, 120 V secondary)	<b>C341CE</b>
100 VA CPT kit (240/480 V primary, 120 V secondary)	<b>C341CC</b>
Fuse clip kit for combination starter—30 A / 250 V	<b>C351KC21</b>
Fuse clip kit for combination starter—30 A / 600 V and 60 A / 250 V	<b>C351KD22-61</b>

### NEMA accessories—cover control kits

<b>Description</b>	<b>Catalog number</b>		
	<b>Non-combination Type 1, size 00–2</b>	<b>Non-combination Type 1, size 3–5</b>	<b>Combination Type 1 and all Type 3R, 12, 4X</b>
STOP/START pushbuttons	<b>C600M1</b>	<b>C400GK1</b>	<b>C400T1</b>
STOP/START pushbuttons with red RUN light (85–264 Vac)	<b>C600M101A</b>	<b>C400GK12</b>	—
HAND/OFF/AUTO selector switch	<b>C600M12</b>	<b>C400GK3</b>	<b>C400T12</b>
HAND/OFF/AUTO selector switch with red RUN light (85–264 Vac)	<b>C600M121A</b>	<b>C400GK32</b>	—

## Catalog numbering system—enclosed lighting contactors

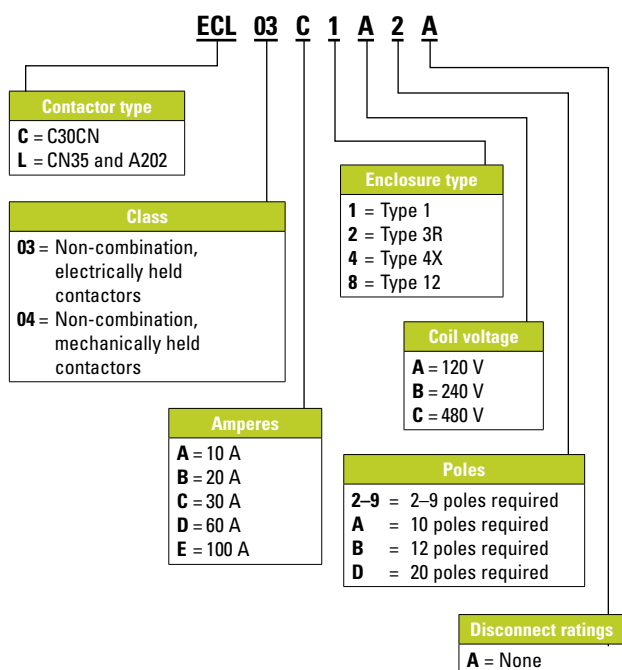

## Lighting contactors

### Lighting non-combination contactors, Type 1

Contactor type	Number of poles	Ampere rating	Coil voltage	Catalog number
C30CN, electrically held	2	30	120	<b>ECC03C1A2A</b>
C30CN, electrically held	4	30	120	<b>ECC03C1A4A</b>
C30CN, electrically held	6	30	120	<b>ECC03C1A6A</b>
CN35, electrically held	2	20	120	<b>ECL03B1A2A</b>
CN35, electrically held	4	20	120	<b>ECL03B1A4A</b>
CN35, electrically held	6	20	120	<b>ECL03B1A6A</b>

# Questions to ask

## Step

1

**Q** Do you need an assembled pushbutton station or loose components in clam-shell packaging?

**A** — Assembled pushbutton station  
— Loose components in clam-shell package

## Step

2

For pushbutton stations

**Q** What size of pushbutton station do you need?

**A** — 22 mm  
— 30 mm

**Q** How many elements (operators) do you want?

**A** — 1  
— 2  
— 3

## Step

3

For loose components

**Q** What type of operator do you need?

**A** — Emergency stop operator  
— Momentary pushbutton  
— Indicating light  
— Illuminated pushbutton  
— Selector switches

# Pushbutton stations and pushbuttons

## Pushbutton stations

### 30 mm pushbutton stations

Description	Catalog number
<b>Single-element</b>	
Emergency Off—break glass pushbutton station, NC	<b>10250TGR</b>
Man-Off-Auto selector switch pushbutton station, 2NO	<b>10250T3524</b>
Stop mushroom head pushbutton station, 1NC	<b>10250T3519</b>
<b>Two-element</b>	
Start-Stop pushbutton station, 1NO-2NC	<b>10250T3525</b>
Start-Stop rectangular pushbutton station, 1NO-1NC	<b>10250H5200</b>
<b>Three-element</b>	
Open-Close-Stop pushbutton station, 2NO-3NC	<b>10250T3614</b>
Up-Down-Stop rectangular pushbutton station, 2NO-1NC	<b>10250H5301</b>

### 22 mm pushbutton stations

Description	Catalog number
<b>Single-element</b>	
40 mm mushroom head push-pull emergency stop operator, NC	<b>M22-C1-M1H</b>
40 mm illuminated mushroom head push-pull emergency stop operator, 85–264 Vac, NO-NC	<b>M22-C1-M2H</b>
<b>Two-element</b>	
Flush pushbutton, Start-Stop, NO-NC	<b>M22-C2-M2V</b>
Flush pushbutton, Forward-Reverse, 2NO	<b>M22-C2-M3V</b>
<b>Three-element</b>	
Flush pushbutton, Open-Stop-Close, 2NO-1NC	<b>M22-C3-M4V</b>
Flush pushbutton, Forward-Stop-Reverse, 2NO-1NC	<b>M22-C3-M5V</b>
Flush pushbutton, Up-Stop-Down, 2NO-NC	<b>M22-C3-M6V</b>

## Pushbutton components

### Individually packaged 30 mm pushbuttons and operators NEMA 4, 4X, 12 13

Description	Catalog number
<b>Emergency stop operator</b>	
Red non-illuminated push-pull, 1NO-1NC, includes 2 legend plates: EMERG. STOP and STOP	10250T5B62-1-POP
Jumbo mushroom pushbutton, 1NO-1NC, button engraved EMERG. STOP (button is engraved—no legend plate provided)	10250T33-POP
Red mushroom pushbutton engraved EMERG. STOP, 1NO-1NC, includes 2 legend plates: EMERG. STOP and STOP	10250T32R-POP
<b>Momentary pushbutton</b>	
Black flush pushbutton, 1NO-1NC, includes 1 legend plate: START and JOG	10250T30B-POP
Red extended pushbutton, 1NO-1NC, includes 1 legend plate: STOP	10250T31R-POP
<b>Indicating light</b>	
Red indicating light transformer 120 Vac with two extra lenses (green and amber), 1NO-1NC, includes 2 legend plates: RUN and JOG	10250T34R-POP
<b>Illuminated pushbutton</b>	
Red illuminated pushbutton (120 Vac/Vdc), with 2 extra lenses (green and amber), 1NO-1NC, includes 1 legend plate: Power On	10250T411C21-1-POP
<b>Selector switches</b>	
Two-position selector switch, 1NO-1NC, includes 3 legend plates: Off/On, Hand/Auto and Run/Jog	10250T20KB-POP
Three-position selector switch, 2NO-2NC, includes 1 legend plate: Hand/Off/Auto	10250T22KB-POP
Three-position selector switch, 1NO-1NC, includes 1 legend plate: Hand/Off/Auto	10250T21KB-POP

# Questions to ask

## Step

1

**Q** What is the motor nameplate information?

- A**
- System (AC or DC) and voltage?
  - If AC, is the motor single-phase or three-phase?
  - What is the motor horsepower?

## Step

2

**Q** What type of enclosure is needed?

- A**
- No enclosure (will be mounted in separate enclosure)
  - NEMA 1 enclosure

## Step

3

**Q** Is overload protection required?

- A**
- No
  - Yes. If yes, what is the motor full load amperes (FLA)?

## Step

4

**Q** What type of operator does the customer want?

- A**
- Button
  - Toggle

# Manual starters



## Manual starters

### Manual motor switches without overload

Type	Pole config.	Maximum motor (hp)				Catalog number	
		120 V	240 V	480 V	230 V	Open	Enclosed
B230A	Two-pole	2	5	—	—	B230AN	B230AG
B230B	Two-pole	2	5	10	15	B230BND	B230BGD
	Three-pole	3	7.5	15	20	B330AND	B330AGD

### Single-phase manual starters with overload protection— Type MS series starters ①

Pole config.	NEMA size	Maximum motor (hp)			Catalog number	
		AC voltage			Open	Enclosed ②
		120 Vac	240 Vac	277 Vac		
Single-pole	1	1	1	MST01	MST01SN1P	
Two-pole	1	1	1	MST02	MST02SN1P	

Pole config.	NEMA size	Maximum motor (hp)			Catalog number	
		DC voltage			Open	Enclosed ②
		120 Vdc	240 Vdc	32 Vdc		
Single-pole	¼	¼	¼	MST01	MST01SN1P	
Two-pole	¼	¼	¼	MST02	MST02SN1P	

① Use MSH heaters for MS series starters.

② With pilot light.

### Single- and three-phase manual starters with overload protection— Type B100 ①

Pole config.	NEMA size	Maximum motor (hp)			Catalog number	
		AC voltage			Open	Enclosed ②
120 Vac	208–240 Vac	480–600 Vac				
Two-pole (single-phase)	0	1	2	—	B100M0B	B100S0B
	1	2	3	—	B100M1B	B100S1B
Three-pole (three-phase)	0	2	3	5	B100M0C	B100S0C
	1	3	7½	10	B100M1C	B100S1C

Pole config.	NEMA size	Maximum motor (hp)		Catalog number	
		DC voltage		Open	Enclosed ②
115 Vdc	230 Vdc				
Two-pole (single-phase)	0	1	1½	B100M0B	B100S0B
	1	1½	2	B100M1B	B100S1B
Three-pole (three-phase)	0	—	—	B100M0C	B100S0C
	1	—	—	B100M1C	B100S1C

① Use FH heaters for Type B100 starters.

② NEMA 1.





\* At Eaton, we believe that power is a fundamental part of just about everything people do. Technology, transportation, energy and infrastructure—these are things the world relies on every day. That's why Eaton is dedicated to helping our customers find new ways to manage electrical, hydraulic and mechanical power more efficiently, safely and sustainably. To improve people's lives, the communities where we live and work, and the planet our future generations depend upon. Because that's what really matters. And we're here to make sure it works.

See more at [Eaton.com/whatmatters](https://www.eaton.com/whatmatters)

For more information, visit  
[Eaton.com/powrstock](https://www.eaton.com/powrstock)

Eaton is a registered trademark.

All other trademarks are property of their respective owners.

**Eaton**  
1000 Eaton Boulevard  
Cleveland, OH 44122  
United States  
[Eaton.com](https://www.eaton.com)

© 2018 Eaton  
All Rights Reserved  
Printed in USA  
Publication No. CA08307001E / Z20429  
February 2018

**EATON**  
*Powering Business Worldwide*

# Pow-R-Stock<sup>Plus</sup> quick selector reference guide

Frequently used distribution  
and control products available  
from distributor stock



**EATON**

*Powering Business Worldwide*

## Table of contents



## Pow-R-Stock panelboards

Questions to ask .....	5
Catalog numbering .....	6
Interiors, EZ Boxes and EZ Trims.....	8
Branch circuit breakers .....	10
Universal main circuit breaker kits— top or bottom mounting .....	11
Lug kits and accessories .....	13



## Safety switches/ disconnects

Questions to ask .....	14
Catalog numbering .....	15
General-duty safety switches .....	16
Heavy-duty safety switches .....	17
Safety switch kits .....	18



## Transformers

Questions to ask .....	19
Catalog numbering .....	20
General-purpose transformers.....	22
Sizing tables .....	24



## Enclosed control

Questions to ask .....	25
Catalog numbering .....	26
NEMA non-combination, non-reversing starters, Type 1 .....	26
NEMA combination, non-reversing starters, non-fusible disconnect, Type 1 ....	26
NEMA accessories.....	27
Lighting contactors.....	28



## Pushbutton stations and pushbuttons

Questions to ask .....	29
30 mm pushbutton stations .....	30
22 mm pushbutton stations .....	30
Individually packaged 30 mm pushbuttons and operators.....	31



# Manual starters

- Questions to ask ..... 32
- Manual motor switches without overload ..... 33
- Single-phase manual starter with overload protection ..... 33
- Single- and three-phase manual starters with  
overload protection ..... 33



# Questions to ask

## Step

1

Select an interior

**Q** What is your voltage?

**A** — 120/240 V single-phase, three-wire  
— 208Y/120 V three-phase, four-wire  
— 480Y/277 V three-phase, four-wire

**Q** What is your busbar rating?

**A** — 100 A (aluminum or copper)  
— 225 A (aluminum or copper)  
— 400 A (aluminum or copper)  
— 600 A (aluminum or copper)

**Q** What is the number of branch circuits/poles?

**A** — 18  
— 30  
— 42

## Step

2

Enclosure type

**Q** What enclosure is required?

**A** — NEMA® 1 indoor  
— NEMA 3R outdoor

## Step

3

Trim type

**Q** For NEMA 1 indoor panels, will the panel be mounted recessed in the wall or mounted directly to the wall?

**A** — Flush  
— Surface

## Step

4

**Q** What is the cable entry locations for the incoming feeder?

**A** — Top  
— Bottom

## Step

5

Main device

**Q** Main lugs only (MLO) or main circuit breaker?

**A** — MLO  
— MCB (choose amperage and top or bottom)

# Pow-R-Stock panelboards (unassembled)

## Catalog numbering system— Pow-R-Stock panelboard interiors

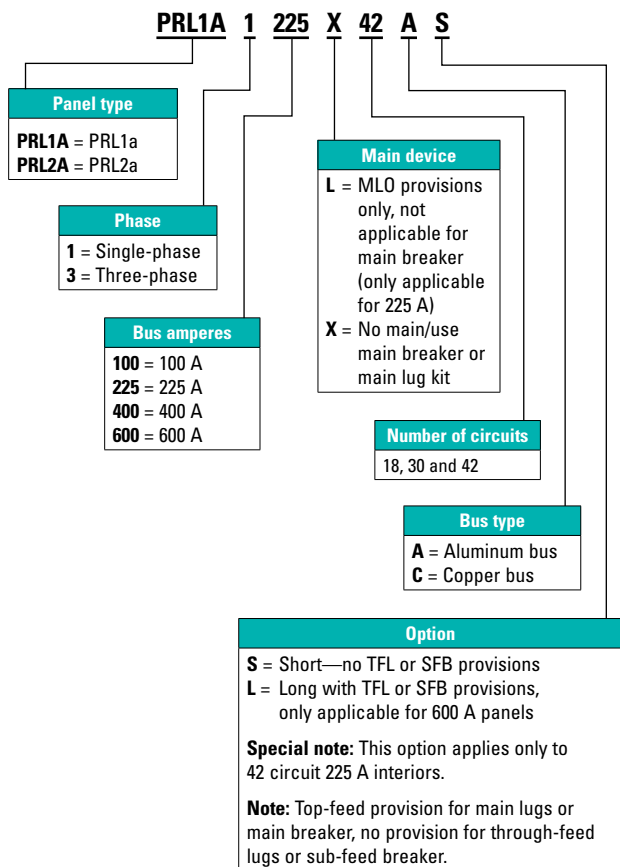

## Catalog numbering system— EZ Panel factory-assembled stock panelboards

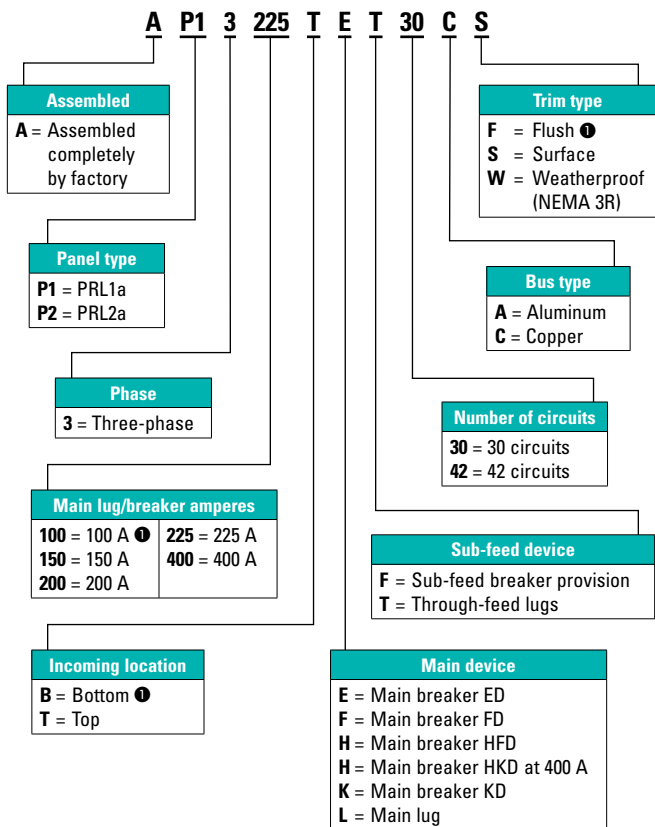

❶ These items are not part of the initial launch. Please consult VISTA or your Eaton sales engineer for product availability.

**Notes:** Not all combinations may be valid. Please verify availability of catalog number created. Refer to PA014007EN for more information on the EZ Panel.

## Pow-R-Stock panelboards—EZ™ Boxes and EZ Trims

Ampere rating	Max. number of poles	Capability				Sub-feed breaker (225 A max.)	Catalog numbers
		Main lugs	Main breaker	Through-feed lugs	Interiors (less main device)		
					Aluminum bus		
<b>Single-phase, three-wire 120/240 Vac</b>							
100	18	■	■	■	N/A	PRL1A1100X18A	
100	30	■	■	■	100	PRL1A1100X30A	
100	42	■	■	■	N/A	PRL1A1100X42A	
225	30	■	■	■	100, 125, 150, 175, 200, 225	PRL1A1225X30A	
225	42	■	■	N/A	N/A	PRL1A1225X42AS ❶	
225	42	■	■	■	100, 125, 150, 175, 200, 225	PRL1A1225X42A	
400	42	■	■	N/A	N/A	PRL1A1400X42AS ❶	
400	42	■	■	■	100, 125, 150, 175, 200, 225	PRL1A1400X42A	
600	42	■	■	■	N/A		
600	42	■	■	■	100, 125, 150, 175, 200, 225, 250, 300, 350, 400		
<b>Three-phase, four-wire 208Y/120 Vac</b>							
100	18	■	■	■	N/A	PRL1A3100X18A	
100	30	■	■	■	100	PRL1A3100X30A	
100	42	■	■	■	N/A	PRL1A3100X42A	
225	30	■	■	■	100, 125, 150, 175, 200, 225	PRL1A3225X30A	
225	42	■	N/A	N/A	N/A	PRL1A3225L42AS ❶	
225	42	■	■	N/A	N/A	PRL1A3225X42AS ❶	
225	42	■	■	■	100, 125, 150, 175, 200, 225	PRL1A3225X42A	
400	42	■	■	N/A	N/A	PRL1A3400X42AS ❶	
400	42	■	■	■	100, 125, 150, 175, 200, 225	PRL1A3400X42A	
600	42	■	■	■	N/A		
600	42	■	■	■	100, 125, 150, 175, 200, 225, 250, 300, 350, 400		
<b>Three-phase, four-wire 480Y/277 Vac</b>							
100	18	■	■	■	N/A	PRL2A3100X18A	
100	30	■	■	■	100	PRL2A3100X30A	
100	42	■	■	■	N/A	PRL2A3100X42A	
225	30	■	■	■	100, 125, 150, 175, 200, 225	PRL2A3225X30A	
225	42	■	N/A	N/A	N/A	PRL2A3225L42AS ❶	
225	42	■	■	N/A	N/A	PRL2A3225X42AS ❶	
225	42	■	■	■	100, 125, 150, 175, 200, 225	PRL2A3225X42A	
400	42	■	■	N/A	N/A	PRL2A3400X42AS ❶	
400	42	■	■	■	100, 125, 150, 175, 200, 225	PRL2A3400X42A	
600	42	■	■	■	N/A		
600	42	■	■	■	100, 125, 150, 175, 200, 225, 250, 300, 350, 400		

❶ S = Short—no TFL or SFB provisions.

Copper bus	Boxes	Trims (NEMA 1)		NEMA 3R enclosures
	NEMA 1	Surface	Flush	
PRL1A1100X18C	EZB2036R	EZT2036S	EZT2036F	GWPBQ2036PR
PRL1A1100X30C	EZB2048R	EZT2048S	EZT2048F	GWPBQ2048PR
PRL1A1100X42C	EZB2048R	EZT2048S	EZT2048F	GWPBQ2048PR
PRL1A1225X30C	EZB2048R	EZT2048S	EZT2048F	GWPBQ2048PR
PRL1A1225X42CS ①	EZB2048R	EZT2048S	EZT2048F	GWPBQ2048PR
PRL1A1225X42C	EZB2060R	EZT2060S	EZT2060F	GWPBQ2060PR
PRL1A1400X42CS ①	EZB2060R	EZT2060S	EZT2060F	GWPBQ2060PR
PRL1A1400X42C	EZB2072R	EZT2072S	EZT2072F	GWPBQ2072PR
PRL1A1600X42C	EZB2072R	EZT2072S	EZT2072F	GWPBQ2072PR
PRL1A1600X42CL	EZB2090R	EZT2090S	EZT2090F	GWPBQ2090PR
PRL1A3100X18C	EZB2036R	EZT2036S	EZT2036F	GWPBQ2036PR
PRL1A3100X30C	EZB2048R	EZT2048S	EZT2048F	GWPBQ2048PR
PRL1A3100X42C	EZB2048R	EZT2048S	EZT2048F	GWPBQ2048PR
PRL1A3225X30C	EZB2048R	EZT2048S	EZT2048F	GWPBQ2048PR
PRL1A3225L42CS ①	EZB2042R	EZT2042S	EZT2042F	GWPBQ2042PR
PRL1A3225X42CS ①	EZB2048R	EZT2048S	EZT2048F	GWPBQ2048PR
PRL1A3225X42C	EZB2060R	EZT2060S	EZT2060F	GWPBQ2060PR
PRL1A3400X42CS ①	EZB2060R	EZT2060S	EZT2060F	GWPBQ2060PR
PRL1A3400X42C	EZB2072R	EZT2072S	EZT2072F	GWPBQ2072PR
PRL1A3600X42C	EZB2072R	EZT2072S	EZT2072F	GWPBQ2072PR
PRL1A3600X42CL	EZB2090R	EZT2090S	EZT2090F	GWPBQ2090PR
PRL2A3100X18C	EZB2036R	EZT2036S	EZT2036F	GWPBQ2036PR
PRL2A3100X30C	EZB2048R	EZT2048S	EZT2048F	GWPBQ2048PR
PRL2A3100X42C	EZB2048R	EZT2048S	EZT2048F	GWPBQ2048PR
PRL2A3225X30C	EZB2048R	EZT2048S	EZT2048F	GWPBQ2048PR
PRL2A3225L42CS ①	EZB2042R	EZT2042S	EZT2042F	GWPBQ2042PR
PRL2A3225X42CS ①	EZB2048R	EZT2048S	EZT2048F	GWPBQ2048PR
PRL2A3225X42C	EZB2060R	EZT2060S	EZT2060F	GWPBQ2060PR
PRL2A3400X42CS ①	EZB2060R	EZT2060S	EZT2060F	GWPBQ2060PR
PRL2A3400X42C	EZB2072R	EZT2072S	EZT2072F	GWPBQ2072PR
PRL2A3600X42C	EZB2072R	EZT2072S	EZT2072F	GWPBQ2072PR
PRL2A3600X42CL	EZB2090R	EZT2090S	EZT2090F	GWPBQ2090PR

**Note:** The colors shown in the tables correspond to the color coding on the trim, interior and box product packaging labels. Be sure that all three parts match when delivering to your customer.

**Note:** Distributors can purchase boxes in quantities via the Distributor toolbox.

## Branch circuit breakers

Summary of branch breakers available

Breaker	No. of poles	Ampere rating	Voltage	kAIC rating	Example	Panel type
BAB ①②	1	15–70	120	10	<b>BAB1020</b>	PRL1a
	2	15–100	120/240	10	<b>BAB2020</b>	PRL1a
	2	15–100	240	10	<b>BAB2040H</b>	PRL1a
	3	15–100	240	10	<b>BAB3030H</b>	PRL1a
QBAF	1	15–20	120	10	<b>QBAF1020</b>	PRL1a
QBHAF	1	15–20	120	22	<b>QBHAF1020</b>	PRL1a
QBCAF	1	15–20	120	10	<b>QBCAF1020</b>	PRL1a
QBHCAF	1	15–20	120	22	<b>QBHCAF1020</b>	PRL1a
QBGFT	1	15–40	120	10	<b>QBGFT1020</b>	PRL1a
	2	15–50	120/240	10	<b>QBGFT2040</b>	PRL1a
QBHGFT	1	15–30	120	22	<b>QBHGFT1020</b>	PRL1a
	2	15–30	120/240	22	<b>QBHGFT2020</b>	PRL1a
QBGFEP	1	15–40	120	10	<b>QBGFEP1020</b>	PRL1a
	2	15–50	120/240	10	<b>QBGFEP2020</b>	PRL1a
QBHGFEF	1	15–30	120	22	<b>QBHGFEF1020</b>	PRL1a
	2	15–30	120/240	22	<b>QBHGFEF2020</b>	PRL1a
QBHW ①	1	15–70	120	22	<b>QBHW1020</b>	PRL1a
	2	15–100	120/240	22	<b>QBHW2020</b>	PRL1a
	2	15–100	240	22	<b>QBHW2040H</b>	PRL1a
	3	15–100	240	22	<b>QBHW3030H</b>	PRL1a
GHQ ①	1	15–20	277	14	<b>GHQ1020</b>	PRL2a
GHB ①②	1	15–100	277	14	<b>GHB1020</b>	PRL2a
	2	15–100	480Y/277	14	<b>GHB2040</b>	PRL2a
	3	15–100	480Y/277	14	<b>GHB3060</b>	PRL2a

① BAB, QBHW, GHQ and GHB breakers installed in PRL1a and PRL2a are available with shunt trip, i.e., BAB1020S.

② BAB-H and GHB 50–100 A available as chassis-mounted main device.

## Universal main circuit breaker kits— top or bottom mounting

### Kits—main circuit breaker (includes circuit breaker and terminals)

Max. volt.	Ampere rating	Service	Breaker frame	Mounting location	Wire range Al/Cu (in kcmil)	Catalog number
240 Vac	100	Single- or three-phase	ED	Universal	(1) #14–1/0	<b>BKED100</b>
	125	Single- or three-phase	ED	Universal	(1) #4–4/0	<b>BKED125</b>
	150	Single- or three-phase	ED	Universal	(1) #4–4/0	<b>BKED150</b>
	175	Single- or three-phase	ED	Universal	(1) #4–4/0 ①	<b>BKED175</b>
	200	Single- or three-phase	ED	Universal	(1) #4–4/0 ①	<b>BKED200</b>
	225	Single- or three-phase	ED	Universal	(1) #4–4/0 ①	<b>BKED225</b>
480 Vac	100	Single- or three-phase	FD	Universal	(1) #14–1/0	<b>BKFD100</b>
	110	Single- or three-phase	FD	Universal	(1) #4–4/0	<b>BKFD110</b>
	125	Single- or three-phase	FD	Universal	(1) #4–4/0	<b>BKFD125</b>
	150	Single- or three-phase	FD	Universal	(1) #4–4/0	<b>BKFD150</b>
	175	Single- or three-phase	FD	Universal	(1) #4–4/0 ①	<b>BKFD175</b>
	200	Single- or three-phase	FD	Universal	(1) #4–4/0 ①	<b>BKFD200</b>
	225	Single- or three-phase	FD	Universal	(1) #4–4/0 ①	<b>BKFD225</b>
480 Vac	100	Single- or three-phase	HFD	Universal	(1) #14–1/0	<b>BKHFD100</b>
	110	Single- or three-phase	HFD	Universal	(2) #4–4/0	<b>BKHFD110</b>
	125	Single- or three-phase	HFD	Universal	(2) #4–4/0	<b>BKHFD125</b>
	150	Single- or three-phase	HFD	Universal	(2) #4–4/0	<b>BKHFD150</b>
	175	Single- or three-phase	HFD	Universal	(2) #4–4/0	<b>BKHFD175</b>
	200	Single- or three-phase	HFD	Universal	(2) #4–4/0	<b>BKHFD200</b>
	225	Single- or three-phase	HFD	Universal	(2) #4–4/0	<b>BKHFD225</b>
480 Vac	250	Single- or three-phase	KD	Universal	(1) 250–500	<b>BKKD250</b>
	300	Single- or three-phase	KD	Universal	(1) 250–500	<b>BKKD300</b>
	350	Single- or three-phase	KD	Universal	(1) 250–500	<b>BKKD350</b>
	400	Single- or three-phase	KD	Universal	(2) 3/0–250 or (1) 3/0–500	<b>BKKD400</b>

① Order optional lug kit catalog no. 3TA225FDK for 175–225 A ED- and FD-Frame three-pole circuit breakers to provide terminations for (1) #6–300 kcmil.

**Note:** KD kits are to be used on 400 A and 600 A panels only.

## Universal main circuit breaker kits— top or bottom mounting

### Kits—main circuit breaker (includes circuit breaker and terminals)

Max. volt.	Ampere rating	Service	Breaker frame	Mounting location	Wire range Al/Cu (in kcmil)	Catalog number
480 Vac	250	Single- or three-phase	HKD	Universal	(1) 250–500	<b>BKHKD250</b>
	300	Single- or three-phase	HKD	Universal	(1) 250–500	<b>BKHKD300</b>
	350	Single- or three-phase	HKD	Universal	(1) 250–500	<b>BKHKD350</b>
	400	Single- or three-phase	HKD	Universal	(1) 250–500	<b>BKHKD400</b>
480 Vac	400	Single- or three-phase	LG	Universal	(1) #2–500	<b>BKLGE400</b>
	500	Single- or three-phase	LG	Universal	(2) #2–500	<b>BKLGE500</b>
	600	Single- or three-phase	LG	Universal	(2) #2–500	<b>BKLGE600</b>



## Lug kits and accessories

### Standard main/sub-feed breaker lug capacities

Ampere rating	Lug wire range Al/Cu
100	(1) #14–1/0
125–225	(1) #4–4/0
250–350	(1) 250–500 kcmil
400	(2) 3/0–250 kcmil or (1) 3/0–500 kcmil

### Main/through-feed lug kits

Ampere rating	Wire range Al/Cu	Catalog number
100	(1) #14–1/0	<b>LUGKIT100</b>
225	(1) #6–300 kcmil	<b>LUGKIT225</b>
400	(2) #2–500 kcmil	<b>LUGKIT400</b>
600	(2) #2–500 kcmil	<b>LUGKIT600</b>

### Kits

Description	Catalog number		
	100 A	225 A	400/600 A
Service entrance kit—MLO	<b>SEK1/2 ①</b>	<b>SEK1/2 ①</b>	<b>SEK4/6 ①</b>
Service entrance kit—MCB	<b>SEKB ②④</b> <b>SEKG ③④</b>	<b>SEKF ④⑤</b>	<b>SEKKL ④⑥</b>
200% neutral kit	<b>2NK100</b>	<b>2NK225</b>	<b>1NK400</b>
Sub-feed breaker adapter (used to mount 225 A sub-feed breaker in 400 A panels)	—	—	<b>225ASFBKIT</b>
Sub-feed breaker adapter (used to mount 225 A sub-feed breaker in 600 A panels)	—	—	<b>225BSFBKIT</b>
Sub-feed breaker adapter (used to mount 400 A sub-feed breaker in 600 A panels)	—	—	<b>400ASFBKIT</b>

① Applicable for use with MLO, SE panels only.

② Only applicable for SE PRL1a with chassis-mounted BAB, QBH main breaker.

③ Only applicable for SE PRL2a with chassis-mounted GHB main breaker.

④ Main breaker panels only—includes barrier kit and bonding jumper.

⑤ To be used with F-frame main breaker.

⑥ To be used with K- and L-frame main breaker.

### Accessories

Description	Catalog number
Isolated ground bar kit	<b>ISOGROUND</b>
Copper ground bar kit	<b>CUGROUND</b>
1P filler plate ①	<b>5155C62H01</b>
Series rating kit ②	<b>SRK</b>

① Each PRS panel comes with 50% filler plates, e.g., 18 circuit interior contains 9 filler plates.

② Series rating kit includes series rating book and adhesive sleeve and series rating sticker. If panelboard is being series rated higher than the base rating, an SRK is required.

# Questions to ask

## Step 1

1

**Q** Which type of switch do you need?

- A**
- Heavy-duty (DH)
  - General-duty (DG)
  - Double-throw (DT)

## Step 2

2

**Q** What current (ampere) rating do you need?

- A**
- 30, 60, 100, 200, 400, 600, 800, 1200

## Step 3

3

**Q** Should it be fused, non-fused or fusible with neutral?

- A**
- F = Fusible without neutral
  - U = Non-fusible
  - N = Fusible with neutral

## Step 4

4

**Q** How many poles?

- A**
- 1, 2, 3, 4, 6

## Step 5

5

**Q** Choose the maximum circuit voltage.

- A**
- 240 Vac
  - 600 Vac

## Step 6

6

**Q** What type of enclosure do you need?

- A**
- NEMA 1
  - NEMA 3R
  - NEMA 12
  - NEMA 4 painted steel
  - NEMA 4X stainless steel
  - NEMA 4X non-metallic

# Safety switches/ disconnects

## Catalog numbering system—safety switches

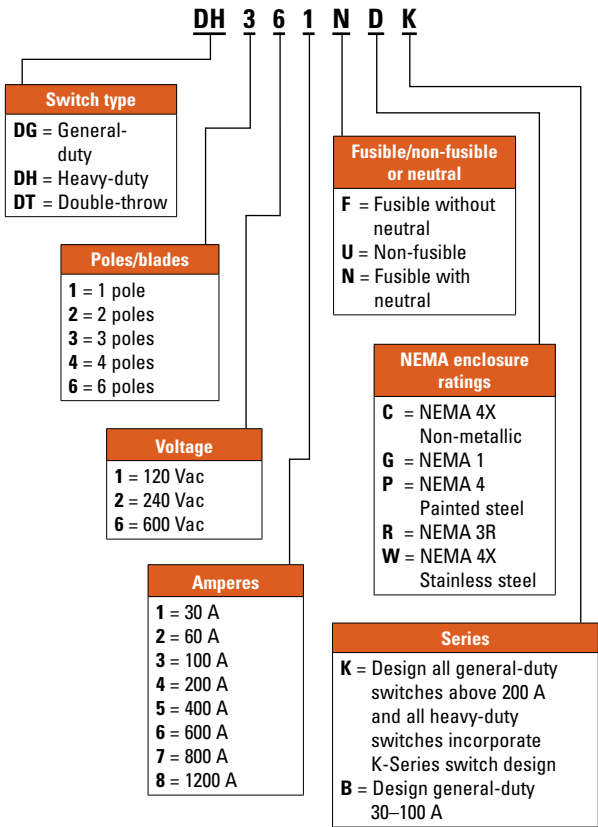

## General-duty safety switches (disconnects)

**Two-pole—240 Vac (suitable for service entrance use with a neutral or ground kit)**

Current rating (amps)	Type	Enclosure type	Max. hp ratings		Catalog number
			Single-phase		
			120 Vac	240 Vac	
30	Fusible with neutral	NEMA 1		1.5–3	DG221NGB
30	Non-fusible	NEMA 1	2	3	DG221UGB
30	Fusible with neutral	NEMA 3R		1.5–3	DG221NRB
30	Non-fusible	NEMA 3R	2	3	DG221URB
60	Fusible with neutral	NEMA 1		3–10	DG222NGB
60	Non-fusible	NEMA 1	3	10	DG222UGB
60	Fusible with neutral	NEMA 3R		3–10	DG222NRB
60	Non-fusible	NEMA 3R	1	10	DG222URB
100	Fusible with neutral	NEMA 1		7.5–15	DG223NGB
100	Non-fusible	NEMA 1		15	DG223UGB
100	Fusible with neutral	NEMA 3R		7.5–15	DG223NRB
100	Non-fusible	NEMA 3R		15	DG223URB

**Three-pole—240 Vac (suitable for service entrance use with a neutral or ground lug kit)**

Current rating (amps)	Type	Enclosure type	Max. hp ratings ①		Catalog number
			Single-phase	Three-phase	
			240 Vac	240 Vac	
30	Fusible with neutral	NEMA 1	1.5–3	3–7.5	DG321NGB
30	Non-fusible	NEMA 1	3	7.5	DG321UGB
30	Fusible with neutral	NEMA 3R	1.5–3	3–7.5	DG321NRB
30	Non-fusible	NEMA 3R	3	7.5	DG321URB
60	Fusible with neutral	NEMA 1	3–10	7.5–15	DG322NGB
60	Non-fusible	NEMA 1	10	15	DG322UGB
60	Fusible with neutral	NEMA 3R	3–10	7.5–15	DG322NRB
60	Non-fusible	NEMA 3R	10	15	DG322URB
100	Fusible with neutral	NEMA 1	7.5–15	15–30	DG323NGB
100	Non-fusible	NEMA 1	15	30	DG323UGB
100	Fusible with neutral	NEMA 3R	7.5–15	15–30	DG323NRB
100	Non-fusible	NEMA 3R	15	30	DG323URB

① Maximum hp ratings for fusible units apply only when dual element time-delay fuses are used.

### Neutral and ground lug kits

Description	Catalog number
Neutral kit for 30 A switches	DG030NB
Neutral kit for 60–100 A switches	DG100NB
Ground lug kit for 30–100 A switches	DG030GB

### Class R fuse adapter kits

Ampere rating	Type	Voltage	Catalog number
30	General-duty	240	DG30RB
60	General-duty	240	DS16FK
100	General-duty	240	DG100RB

## Heavy-duty safety switches (disconnects)

**Three-pole—480–600 Vac (suitable for service entrance use with a neutral or ground lug kit below)**

Current rating (amps)	Type	Enclosure type	Max. hp ratings				Catalog number
			Single-phase		Three-phase		
			480 V	600 V	480 V	600 V	
30	Fusible	NEMA 1	7.5	15	10	20	<b>DH361FGK ❶</b>
30	Non-fusible	NEMA 1	7.5	15	10	20	<b>DH361UGK</b>
30	Fusible	NEMA 3R	7.5	15	10	20	<b>DH361FRK ❶</b>
30	Non-fusible	NEMA 3R	7.5	15	10	20	<b>DH361URK</b>
30	Fusible	NEMA 4X	7.5	10	15	20	<b>DH361FWK ❶</b>
30	Non-fusible	NEMA 4X	7.5	10	20	30	<b>DH361UWK</b>
60	Fusible	NEMA 1	20	30	25	50	<b>DH362FGK</b>
60	Non-fusible	NEMA 1	20	30	25	50	<b>DH362UGK</b>
60	Fusible	NEMA 3R	20	30	25	50	<b>DH362FRK</b>
60	Non-fusible	NEMA 3R	20	30	25	50	<b>DH362URK</b>
60	Fusible	NEMA 4X	20	25	30	50	<b>DH362FWK</b>
60	Non-fusible	NEMA 4X	20	25	50	60	<b>DH362UWK</b>
100	Fusible	NEMA 1	30	60	40	75	<b>DH363FGK</b>
100	Non-fusible	NEMA 1	30	60	40	75	<b>DH363UGK</b>
100	Fusible	NEMA 3R	30	60	40	75	<b>DH363FRK</b>
100	Non-fusible	NEMA 3R	30	60	40	75	<b>DH363URK</b>
100	Fusible	NEMA 4X	30	40	60	75	<b>DH363FWK</b>
100	Non-fusible	NEMA 4X	40	50	75	100	<b>DH363UWK</b>
200	Fusible	NEMA 1	50	125	50	150	<b>DH364FGK</b>
200	Non-fusible	NEMA 1	50	125	50	150	<b>DH364UGK</b>
200	Fusible	NEMA 3R	50	125	50	150	<b>DH364FRK</b>
200	Non-fusible	NEMA 3R	50	125	50	150	<b>DH364URK</b>
200	Fusible	NEMA 4X	50	50	125	150	<b>DH364FWK</b>
200	Non-fusible	NEMA 4X	50	50	125	125	<b>DH364UWK</b>

❶ For 30 A switches requiring Class J fusing, switch must be ordered with the Class J clips from the factory by adding a suffix "J" on the end.

## Safety switch kits

### Neutral and ground lug kits ①

Description	Catalog number
Neutral kit for 30–60 A switches	DH030NK
Neutral kit for 100 A switches	DH100NK
Neutral kit for 200 A switches	DG200NK
Ground lug kit for 30–100 A switches	DS100GK
Ground lug kit for 200 A switches	DS200GK

① A factory-installed ground lug is supplied on all NEMA 4, 4X and 12 safety switches, as well as all 400 A and higher NEMA 1 and 3R safety switches. A factory-installed ground lug is also supplied on all heavy-duty NEMA 1 and 3R 30–200 A switches that do not have a factory installed neutral.

### Class R fuse adapter kits

Ampere rating	Type	Voltage	Catalog number
30	Heavy-duty	600	DS16FK
60	Heavy-duty	600	DS26FK
100	Heavy-duty	600	DS36FK
200	Heavy-duty	600	DS346FK

### Class J fuse adapter kit ①

Ampere rating	Type	Voltage	Catalog number
60	Heavy-duty	600	DS26JK

① 30 A switches must be ordered from the factory with Class J fuse provisions by adding suffix “J” at the end of the switch catalog number. 100 A and 200 A switches can be field modified by moving the load side fuse base.

# Questions to ask

## Step 1

1

**Q** How many phases?

**A** — Single-phase  
— Three-phase

## Step 2

2

**Q** What type of enclosure is required?

**A** — Ventilated  
— Encapsulated

## Step 3

3

**Q** What is the primary voltage? (input voltage)

**A** — Single-phase is 240 V x 480 V  
— Three-phase is 480 V delta (three-phase, three-wire)

## Step 4

4

**Q** What is the secondary voltage? (output voltage)

**A** — Single-phase  
— 120/240  
  
— Three-phase  
— 208Y/120 (three-phase, four-wire) or 240 V delta

## Step 5

5

**Q** What kVA transformer is required?

**A** — If single-phase encapsulated, kVAs are:  
0.05, 0.075, 0.1, 0.15, 0.25, 0.5, 0.75, 1,  
1.5, 2, 3, 5, 7.5, 10, 15, 25, 37.5  
— If single-phase ventilated, kVAs are:  
15, 25, 37.5, 50, 75, 100, 167  
— If three-phase encapsulated, kVAs are:  
3, 6, 9, 15, 30, 45, 75  
— If three-phase ventilated, kVAs are:  
15, 30, 45, 75, 112.5, 150, 225, 300

## Step 6

6

**Q** If a ventilated transformer was selected

**A** — Field kits: lug kits or weathershields  
— Select from selection tables

# Transformers

# Catalog numbering system—DOE 2016 ventilated transformers

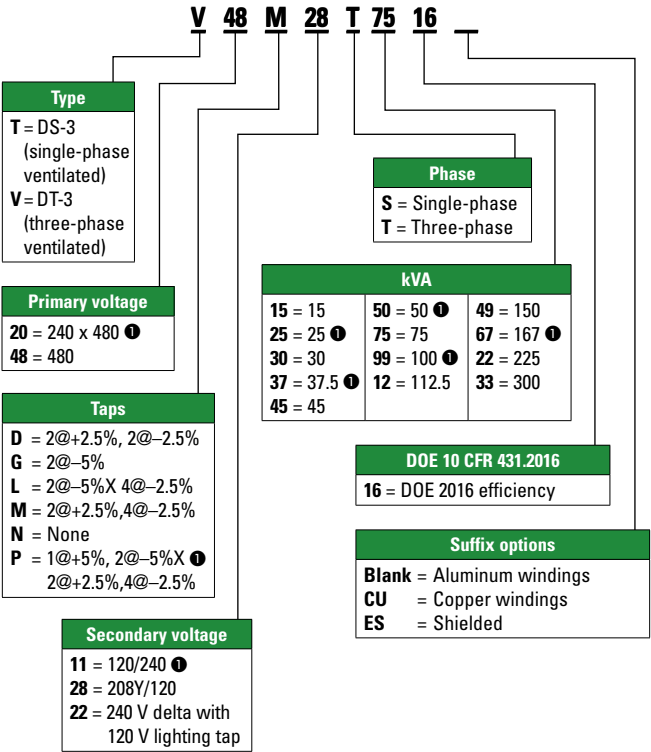

① Typically used with single-phase transformers.



## Catalog numbering system—encapsulated transformers

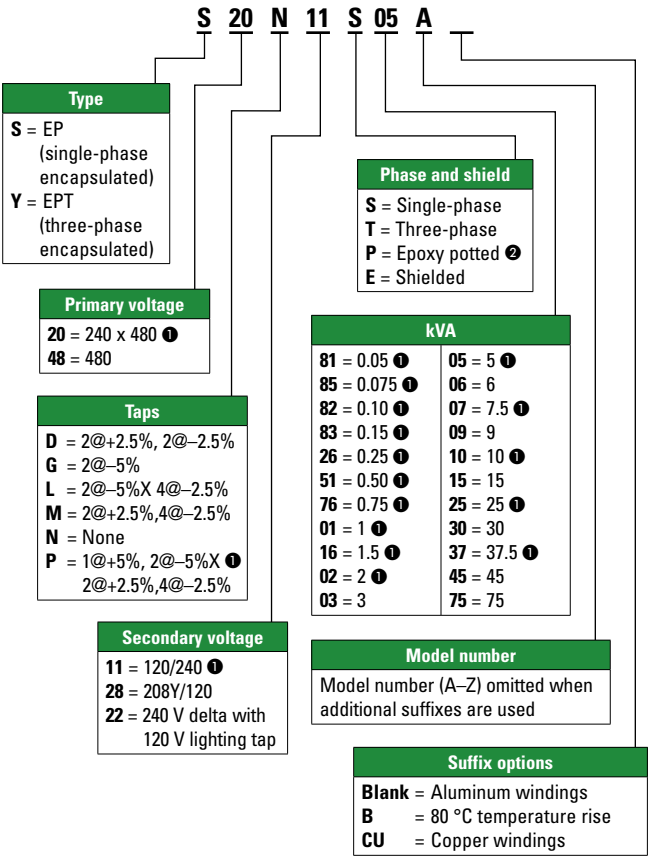

❶ Typically used with single-phase transformers.

❷ Single-phase 0.25–2 kVA encapsulated transformers only.

## General-purpose transformers

### Three-phase ventilated, 480 delta—208 Y/120, 150 °C rise, aluminum windings, DOE 2016

kVA	Frame number	Wiring diagram	Weathershield	Typical lug kit	Catalog number
15	939	280B	WS57	LKS1	V48M28T1516 ①
30	940	280B	WS58	LKS1	V48M28T3016 ①
45	940	280B	WS58	LKS1	V48M28T4516 ①
75	942	280B	WS59	LKS2	V48M28T7516 ②
112.5	943	280B	WS60	LKS2	V48M28T1216 ②
150	943	280B	WS60	LKS3	V48M28T4916 ②
225	944	280B	WS61	LKS3	V48M28T2216
300	945	280B	WS62	LKS3	V48M28T3316

① Suitable for use with wall-mounted bracket WMB05.

② Suitable for use with wall-mounted bracket WMB04.

### Three-phase ventilated, 480 delta—240/120 lighting tap, 150 °C rise, aluminum windings, DOE 2016

kVA	Frame number	Wiring diagram	Weathershield	Typical lug kit	Catalog number
15	939	282B	WS57	LKS1	V48M22T1516 ①
30	940	282B	WS58	LKS1	V48M22T3016 ①
45	940	282B	WS58	LKS1	V48M22T4516 ①
75	942	282B	WS59	LKS2	V48M22T7516 ②
112.5	943	282B	WS60	LKS2	V48M22T1216 ②
150	943	282B	WS60	LKS3	V48M22T4916 ②
225	944	282B	WS61	LKS3	V48M22T2216
300	945	282B	WS62	LKS3	V48M22T3316

① Suitable for use with wall-mounted bracket WMB05.

② Suitable for use with wall-mounted bracket WMB04.

### Three-phase encapsulated, 480 delta—208 Y/120, 115 °C rise

kVA	Frame number	Wiring diagram	Catalog number
3	201	70A	Y48G28T03N
6	200	70A	Y48G28T06N
9	103	70A	Y48G28T09N
15	95	72B	Y48D28T15N
30	243	84A	Y48M28T30N
45	244	84A	Y48M28T45N
75	245	84A	Y48M28T75N

**Note:** For frame drawings and wiring diagrams, refer to [www.eaton.com/transformers](http://www.eaton.com/transformers).

## General-purpose transformers

**Single-phase ventilated, 240 x 480–120/240, 150 °C rise, aluminum windings, DOE 2016**

kVA	Frame number	Wiring diagram	Weathershield	Typical lug kit	Catalog number
15	842	3XA	WS45	LKS1	<b>T20P11S1516</b> ①
25	842	3XA	WS45	LKS1	<b>T20P11S2516</b> ①
37.5	843	3XA	WS43	LKS1	<b>T20P11S3716</b>
50	843	3XA	WS43	LKS2	<b>T20P11S5016</b>
75	844	3XA	WS44	LKS2	<b>T20P11S7516</b>
100	844	3XA	WS44	LKS3	<b>T20P11S9916</b>
167	814	288A	WS13	LKS3	<b>T48P11S6716</b> ②

① Suitable for use with wall-mounted bracket WMB01.

② 480 V primary only.

**Single-phase encapsulated 240 x 480–120/240, 115 °C rise**

kVA	Frame number	Wiring diagram	Catalog number
0.05	52	3A	<b>S20N11S81N</b>
0.075	53	3A	<b>S20N11S85N</b>
0.1	54	3A	<b>S20N11S82N</b>
0.15	55	3A	<b>S20N11S83N</b>
0.25	57P	3A	<b>S20N11P26P</b>
0.5	57P	3A	<b>S20N11P51P</b>
0.75	58P	3A	<b>S20N11P76P</b>
1	67P	3A	<b>S20N11P01P</b>
1.5	67P	3A	<b>S20N11P16P</b>
2	68P	3A	<b>S20N11P02P</b>
3	176	3A	<b>S20N11S03N</b>
5	177	3A	<b>S20N11S05N</b>
7.5	178	3A	<b>S20N11S07N</b>
10	179	3A	<b>S20N11S10N</b>
15	180	3A	<b>S20N11S15N</b>
25	182	23A	<b>S20L11S25N</b>
37.5	300A	248A	<b>S20L11S37</b>

**Note:** For frame drawings and wiring diagrams, refer to [www.eaton.com/transformers](http://www.eaton.com/transformers).

## General-purpose transformers sizing tables

### Three-phase transformer full load current

kVA	Rated line-line voltage						
	208	240	480	600	2400	4160	4800
3	8.3	7.2	3.6	2.9	0.7	0.4	0.4
6	16.7	14.4	7.2	5.8	1.4	0.8	0.7
9	25.0	21.7	10.8	8.7	2.2	1.2	1.1
15	41.6	36.1	18.0	14.4	3.6	2.1	1.8
30	83.3	72.2	36.1	28.9	7.2	4.2	3.6
45	124.9	108.3	54.1	43.3	10.8	6.2	5.4
75	208.2	180.4	90.2	72.2	18.0	10.4	9.0
112.5	312.3	270.6	135.3	108.3	27.1	15.6	13.5
150	416.4	360.9	180.4	144.3	36.1	20.8	18.0
225	624.6	541.3	270.6	216.5	54.1	31.2	27.1
300	832.7	721.7	360.9	288.7	72.2	41.6	36.1
500	1387.9	1202.8	601.4	481.1	120.3	69.4	60.1
750	2081.9	1804.3	902.1	721.7	180.4	104.1	90.2
1000	2775.8	2405.7	1202.8	962.3	240.6	138.8	120.3

**Note:** Line current = (kVA x 1000) / (line voltage x 1.732).

### Single-phase transformer full load current

kVA	Rated line-line voltage								
	120	208	240	277	480	600	2400	4160	4800
0.5	4.2	2.4	2.1	1.8	1.0	0.8	0.2	0.1	0.1
1	8.3	4.8	4.2	3.6	2.1	1.7	0.4	0.2	0.2
1.5	12.5	7.2	6.3	5.4	3.1	2.5	0.6	0.4	0.3
2	16.7	9.6	8.3	7.2	4.2	3.3	0.8	0.5	0.4
3	25.0	14.4	12.5	10.8	6.3	5.0	1.3	0.7	0.6
5	41.7	24.0	20.8	18.1	10.4	8.3	2.1	1.2	1.0
7.5	62.5	36.1	31.3	27.1	15.6	12.5	3.1	1.8	1.6
10	83.3	48.1	41.7	36.1	20.8	16.7	4.2	2.4	2.1
15	125.0	72.1	62.5	54.2	31.3	25.0	6.3	3.6	3.1
25	208.3	120.2	104.2	90.3	52.1	41.7	10.4	6.0	5.2
37.5	312.5	180.3	156.3	135.4	78.1	62.5	15.6	9.0	7.8
50	416.7	240.4	208.3	180.5	104.2	83.3	20.8	12.0	10.4
75	625.0	360.6	312.5	270.8	156.3	125.0	31.3	18.0	15.6
100	833.3	480.8	416.7	361.0	208.3	166.7	41.7	24.0	20.8
167	1391.7	802.9	695.8	602.9	347.9	278.3	69.6	40.1	34.8
250	2083.3	1201.9	1041.7	902.5	520.8	416.7	104.2	60.1	52.1
333	2775.0	1601.0	1387.5	1202.2	693.8	555.0	138.8	80.0	69.4

**Note:** Line current = (kVA x 1000) / line voltage.

# Questions to ask

## Step 1

1

**Q** What type of enclosure do you need?

- A**
- NEMA 1 (general-duty)
  - NEMA 3R (rain-tight)
  - NEMA 12 (dust-tight)
  - NEMA 4X (wash-down)

## Step 2

2

**Q** What type of starter do you need?

- A**
- NEMA non-combination
  - NEMA combination, non-fusible or fusible
  - NEMA combination, breaker
  - Lighting contactor

## Step 3

3

**Q** What is the horsepower and voltage of the motor?  
(Note: this will determine the NEMA starter size)

- A**
- Horsepower: 1, 5, 10, 25 hp etc.
  - Motor voltage: 200, 230, 460, 575 V

## Step 4

4

**Q** What is the control voltage for the coil?

- A**
- 120 Vac
  - 240 Vac
  - 480 Vac

## Step 5

5

**Q** What size overload relay is needed?

- A**
- 1–5 FLA
  - 4–20 FLA
  - 9–45 FLA

## Step 6

6

**Q** What additional accessories do you need?

- A**
- Cover control kits, such as HAND/OFF/AUTO selector switch or STOP/START pushbuttons
  - CPT kits
  - Fuse kits

# Enclosed control

## Catalog numbering system—non-combination and combination NEMA enclosed starters

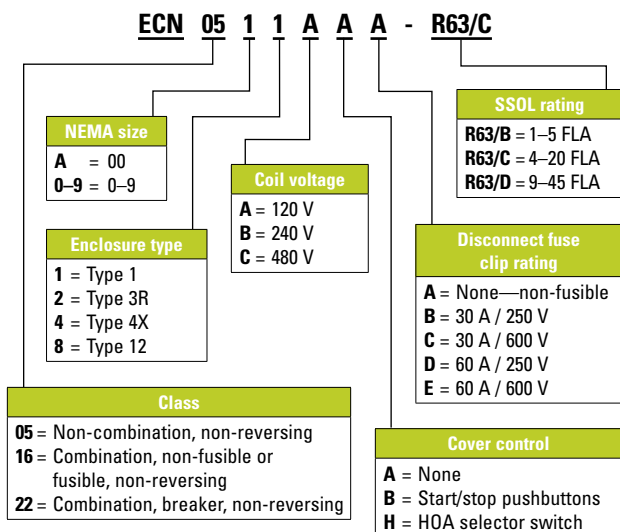

## Starters

### NEMA non-combination, non-reversing starters, Type 1

NEMA size	Motor voltage	Maximum hp rating	Magnet coil voltage	SSOL range	Catalog number
00	200, 230	1-1/2	120	1-5	ECN05A1AAA-R63/B
	460	2	120	1-5	ECN05A1AAA-R63/B
0	200, 230	3	120	1-5	ECN0501AAA-R63/B
	460	5	120	1-5	ECN0501AAA-R63/B
	200, 230	3	120	4-20	ECN0501AAA-R63/C
	460	5	120	4-20	ECN0501AAA-R63/C
1	200, 230	7-1/2	120	4-20	ECN0511AAA-R63/C
	460	10	120	4-20	ECN0511AAA-R63/C
2	200, 230	10	120	9-45	ECN0521AAA-R63/D
	460	25	120	9-45	ECN0521AAA-R63/D

### NEMA combination, non-reversing starters, non-fusible disconnect Type 1

NEMA size	Motor voltage	Maximum hp rating	Magnet coil voltage	SSOL range	Catalog number
00	200, 230	1-1/2	120	1-5	ECN16A1AAA-R63/B
	460	2	120	1-5	ECN16A1AAA-R63/B
0	200, 230	3	120	1-5	ECN1601AAA-R63/B
	460	5	120	1-5	ECN1601AAA-R63/B
	200, 230	3	120	4-20	ECN1601AAA-R63/C
	460	5	120	4-20	ECN1601AAA-R63/C
1	200, 230	7-1/2	120	4-20	ECN1611AAA-R63/C
	460	10	120	4-20	ECN1611AAA-R63/C
2	200, 230	10	120	9-45	ECN1621AAA-R63/D
	460	25	120	9-45	ECN1621AAA-R63/D

## Starters

### NEMA enclosures with CPT modifications

To order an enclosure with CPT:

1. Change ECN05 to ECN07 for non-combination units, and ECN16 to ECN18 for combination units.
2. Change the “A” in the 7th catalog string to the correct letter based on the below table:

<b>Catalog string letter</b>	<b>Primary</b>	<b>Secondary</b>
E	208/60	120/60
B	240/480–220/440 wired for 240 V	120/60–110/50
C	240/480–220/440 wired for 480 V	120/60–110/50

### NEMA accessories—CPT and fuse kits

<b>Description</b>	<b>Catalog number</b>
100 VA CPT kit (208/277 V primary, 120 V secondary)	<b>C341CE</b>
100 VA CPT kit (240/480 V primary, 120 V secondary)	<b>C341CC</b>
Fuse clip kit for combination starter—30 A / 250 V	<b>C351KC21</b>
Fuse clip kit for combination starter—30 A / 600 V and 60 A / 250 V	<b>C351KD22-61</b>

### NEMA accessories—cover control kits

<b>Description</b>	<b>Catalog number</b>		
	<b>Non-combination Type 1, size 00–2</b>	<b>Non-combination Type 1, size 3–5</b>	<b>Combination Type 1 and all Type 3R, 12, 4X</b>
STOP/START pushbuttons	<b>C600M1</b>	<b>C400GK1</b>	<b>C400T1</b>
STOP/START pushbuttons with red RUN light (85–264 Vac)	<b>C600M101A</b>	<b>C400GK12</b>	—
HAND/OFF/AUTO selector switch	<b>C600M12</b>	<b>C400GK3</b>	<b>C400T12</b>
HAND/OFF/AUTO selector switch with red RUN light (85–264 Vac)	<b>C600M121A</b>	<b>C400GK32</b>	—

## Catalog numbering system—enclosed lighting contactors

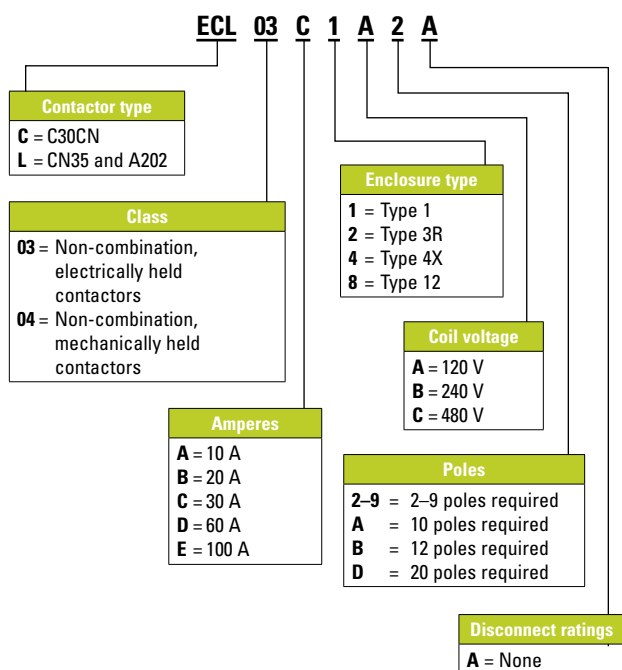

## Lighting contactors

### Lighting non-combination contactors, Type 1

Contactor type	Number of poles	Ampere rating	Coil voltage	Catalog number
C30CN, electrically held	2	30	120	<b>ECC03C1A2A</b>
C30CN, electrically held	4	30	120	<b>ECC03C1A4A</b>
C30CN, electrically held	6	30	120	<b>ECC03C1A6A</b>
CN35, electrically held	2	20	120	<b>ECL03B1A2A</b>
CN35, electrically held	4	20	120	<b>ECL03B1A4A</b>
CN35, electrically held	6	20	120	<b>ECL03B1A6A</b>



# Questions to ask

## Step

1

**Q** Do you need an assembled pushbutton station or loose components in clam-shell packaging?

**A** — Assembled pushbutton station  
— Loose components in clam-shell package

## Step

2

For pushbutton stations

**Q** What size of pushbutton station do you need?

**A** — 22 mm  
— 30 mm

**Q** How many elements (operators) do you want?

**A** — 1  
— 2  
— 3

## Step

3

For loose components

**Q** What type of operator do you need?

**A** — Emergency stop operator  
— Momentary pushbutton  
— Indicating light  
— Illuminated pushbutton  
— Selector switches

# Pushbutton stations and pushbuttons

## Pushbutton stations

### 30 mm pushbutton stations

Description	Catalog number
<b>Single-element</b>	
Emergency Off—break glass pushbutton station, NC	<b>10250TGR</b>
Man-Off-Auto selector switch pushbutton station, 2NO	<b>10250T3524</b>
Stop mushroom head pushbutton station, 1NC	<b>10250T3519</b>
<b>Two-element</b>	
Start-Stop pushbutton station, 1NO-2NC	<b>10250T3525</b>
Start-Stop rectangular pushbutton station, 1NO-1NC	<b>10250H5200</b>
<b>Three-element</b>	
Open-Close-Stop pushbutton station, 2NO-3NC	<b>10250T3614</b>
Up-Down-Stop rectangular pushbutton station, 2NO-1NC	<b>10250H5301</b>

### 22 mm pushbutton stations

Description	Catalog number
<b>Single-element</b>	
40 mm mushroom head push-pull emergency stop operator, NC	<b>M22-C1-M1H</b>
40 mm illuminated mushroom head push-pull emergency stop operator, 85–264 Vac, NO-NC	<b>M22-C1-M2H</b>
<b>Two-element</b>	
Flush pushbutton, Start-Stop, NO-NC	<b>M22-C2-M2V</b>
Flush pushbutton, Forward-Reverse, 2NO	<b>M22-C2-M3V</b>
<b>Three-element</b>	
Flush pushbutton, Open-Stop-Close, 2NO-1NC	<b>M22-C3-M4V</b>
Flush pushbutton, Forward-Stop-Reverse, 2NO-1NC	<b>M22-C3-M5V</b>
Flush pushbutton, Up-Stop-Down, 2NO-NC	<b>M22-C3-M6V</b>

## Pushbutton components

### Individually packaged 30 mm pushbuttons and operators NEMA 4, 4X, 12 13

Description	Catalog number
<b>Emergency stop operator</b>	
Red non-illuminated push-pull, 1NO-1NC, includes 2 legend plates: EMERG. STOP and STOP	10250T5B62-1-POP
Jumbo mushroom pushbutton, 1NO-1NC, button engraved EMERG. STOP (button is engraved—no legend plate provided)	10250T33-POP
Red mushroom pushbutton engraved EMERG. STOP, 1NO-1NC, includes 2 legend plates: EMERG. STOP and STOP	10250T32R-POP
<b>Momentary pushbutton</b>	
Black flush pushbutton, 1NO-1NC, includes 1 legend plate: START and JOG	10250T30B-POP
Red extended pushbutton, 1NO-1NC, includes 1 legend plate: STOP	10250T31R-POP
<b>Indicating light</b>	
Red indicating light transformer 120 Vac with two extra lenses (green and amber), 1NO-1NC, includes 2 legend plates: RUN and JOG	10250T34R-POP
<b>Illuminated pushbutton</b>	
Red illuminated pushbutton (120 Vac/Vdc), with 2 extra lenses (green and amber), 1NO-1NC, includes 1 legend plate: Power On	10250T411C21-1-POP
<b>Selector switches</b>	
Two-position selector switch, 1NO-1NC, includes 3 legend plates: Off/On, Hand/Auto and Run/Jog	10250T20KB-POP
Three-position selector switch, 2NO-2NC, includes 1 legend plate: Hand/Off/Auto	10250T22KB-POP
Three-position selector switch, 1NO-1NC, includes 1 legend plate: Hand/Off/Auto	10250T21KB-POP

# Questions to ask

## Step

1

**Q** What is the motor nameplate information?

- A**
- System (AC or DC) and voltage?
  - If AC, is the motor single-phase or three-phase?
  - What is the motor horsepower?

## Step

2

**Q** What type of enclosure is needed?

- A**
- No enclosure (will be mounted in separate enclosure)
  - NEMA 1 enclosure

## Step

3

**Q** Is overload protection required?

- A**
- No
  - Yes. If yes, what is the motor full load amperes (FLA)?

## Step

4

**Q** What type of operator does the customer want?

- A**
- Button
  - Toggle

# Manual starters

## Manual starters

### Manual motor switches without overload

Type	Pole config.	Maximum motor (hp)				Catalog number	
		120 V	240 V	480 V	230 V	Open	Enclosed
B230A	Two-pole	2	5	—	—	B230AN	B230AG
B230B	Two-pole	2	5	10	15	B230BND	B230BGD
	Three-pole	3	7.5	15	20	B330AND	B330AGD

### Single-phase manual starters with overload protection— Type MS series starters ①

Pole config.	NEMA size	Maximum motor (hp)			Catalog number	
		AC voltage			Open	Enclosed ②
		120 Vac	240 Vac	277 Vac		
Single-pole	0	1	1	1	MST01	MST01SN1P
Two-pole	0	1	1	1	MST02	MST02SN1P

Pole config.	NEMA size	Maximum motor (hp)			Catalog number	
		DC voltage			Open	Enclosed ②
		120 Vdc	240 Vdc	32 Vdc		
Single-pole	0	¼	¼	¼	MST01	MST01SN1P
Two-pole	0	¼	¼	¼	MST02	MST02SN1P

① Use MSH heaters for MS series starters.

② With pilot light.

### Single- and three-phase manual starters with overload protection— Type B100 ①

Pole config.	NEMA size	Maximum motor (hp)			Catalog number	
		AC voltage			Open	Enclosed ②
		120 Vac	208–240 Vac	480–600 Vac		
Two-pole (single-phase)	0	1	2	—	B100M0B	B100S0B
	1	2	3	—	B100M1B	B100S1B
Three-pole (three-phase)	0	2	3	5	B100M0C	B100S0C
	1	3	7½	10	B100M1C	B100S1C

Pole config.	NEMA size	Maximum motor (hp)		Catalog number	
		DC voltage		Open	Enclosed ②
		115 Vdc	230 Vdc		
Two-pole (single-phase)	0	1	1½	B100M0B	B100S0B
	1	1½	2	B100M1B	B100S1B
Three-pole (three-phase)	0	—	—	B100M0C	B100S0C
	1	—	—	B100M1C	B100S1C

① Use FH heaters for Type B100 starters.

② NEMA 1.





\* At Eaton, we believe that power is a fundamental part of just about everything people do. Technology, transportation, energy and infrastructure—these are things the world relies on every day. That's why Eaton is dedicated to helping our customers find new ways to manage electrical, hydraulic and mechanical power more efficiently, safely and sustainably. To improve people's lives, the communities where we live and work, and the planet our future generations depend upon. Because that's what really matters. And we're here to make sure it works.

See more at [Eaton.com/whatmatters](https://www.eaton.com/whatmatters)

For more information, visit  
[Eaton.com/powrstock](https://www.eaton.com/powrstock)

Eaton is a registered trademark.

All other trademarks are property of their respective owners.

**Eaton**  
1000 Eaton Boulevard  
Cleveland, OH 44122  
United States  
[Eaton.com](https://www.eaton.com)

© 2018 Eaton  
All Rights Reserved  
Printed in USA  
Publication No. CA08307001E / Z20429  
February 2018

**EATON**  
*Powering Business Worldwide*