

WEATHERPROOF BOXES & COVERS

WPG1 and WPG2 Thermoplastic/Heavy Cast Aluminum Covers

Two sizes: 1.96" and 2.32" diameters to cover 15A/20A Straight Blade and 15A/20A/30A Turnlok® devices. Covers fit all competitive flanged inlets and outlets.

Stainless steel mounting screws resist corrosion.

- A. Pre-attached gaskets** for easy installation and tight seal to panel or weatherproof box — with no misaligned or collapsed gaskets.
- B. Tamper-proof hinge** features permanent, locked-in pins for added security.
- C. Unbreakable glass-filled polycarbonate construction** withstands years of job site abuse and harsh environmental exposure. Stainless steel mounting screws resist corrosion.
- D. Molded-in label area** for pre-printed or handwritten labels identifying circuits, ratings, and other data.
- E. Lockable "bullnose"** for OSHA Lockout/Tagout compliance.

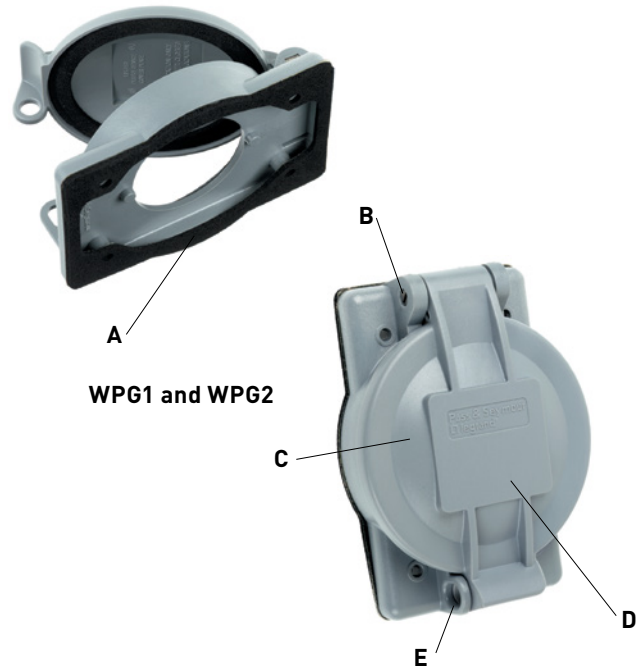

WPG1 and WPG2

WIUCED10SC Extra-Duty White-In-Use Cover

The NEC® Section 406.9(B)(1) requires that an outlet box load installed for this purpose shall be listed and shall be identified as "extra duty".

- A. Exclusive cord flap gasket** inhibits water splash from driving rain or sprinklers.
- B. Sturdy polycarbonate construction** resists impacts and harsh weather.
- C. Patented corner hinge and cord opening** allow vertical or horizontal installation.
- D. Exclusive WaterShed™ Channel** keeps water moving outside while cord flap keeps the inside dry.
- E. Preapplied gasket** easier to install, saves time, won't get lost or damaged.
- F. Paintable, textured finish** hides scratches.
- G. Patented trigger latch** opens easily with one finger, yet is lockable to prevent tampering.
- H. Sturdy, molded-in hinge** withstands hard use.
- I. Installs without removing electrical device**, thanks to patented, keyed mounting holes.
- J. Roomy interior** provides space for plugs and cord bends.

Shallow profile models have 1" shorter top lid than prior models.

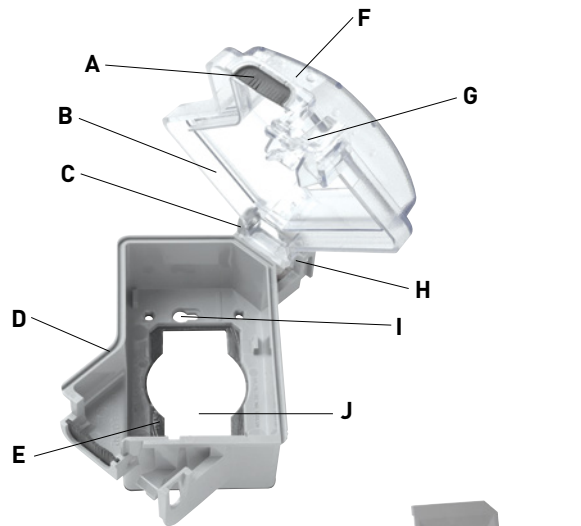

WIUCED10SC

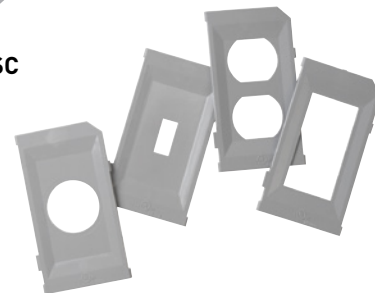

Snap-in device plates require no tools to install and won't fall out. See chart for plates provided with each catalog number.





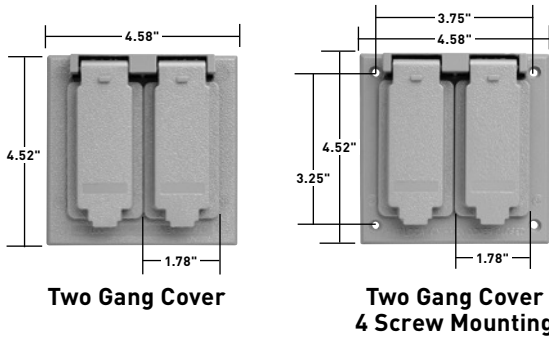







WEATHERPROOF BOXES & COVERS

Cast Weatherproof Covers



Features

- Broad line of two gang covers for switches, receptacles, GFCIs, and power outlets.
- Baked-on electrostatic, polyester, powder paint for superior scratch and corrosion resistance.
- Heavy-duty die-cast zinc.
- Stainless steel springs.
- All covers have 2 self-closing lids.
- Covers comply with NEC® Section 406.9(B)(1).

| CATALOG NUMBER | DESCRIPTION | COLOR | 3RD PARTY COMPLIANCE |
|-----------------|--|---------------|--|
| | | |  |
| TWO GANG | | | |
| CA82G CA82W |  2 Duplex Receptacles | Gray White | • |
| CA72G |  2 Single Receptacles | Gray | • |
| CA78G |  1 Single/1 Duplex 4 Screw Mounting | Gray | • |
| CA726G |  1 Single/1 Decorator 4 Screw Mounting | Gray | • |
| CA262G |  2 Decorator 4 Screw Mounting | Gray | • |
| CA268G |  1 Decorator/1 Duplex 4 Screw Mounting | Gray | • |
| CA17G |  1 Toggle/1 Single 4 Screw Mounting | Gray | • |
| CA18G |  1 Toggle/1 Duplex 4 Screw Mounting | Gray | • |
| CA126GRY |  1 Toggle/1 Decorator 4 Screw Mounting | Gray | • |
| CA2G CA2W |  2 Toggles 4 Screw Mounting | Gray White | • |
| CA2GS |  2 Toggles with 2 15A 120VAC Single Pole Toggle Switches (Cat. # 660) Included 4 Screw Mounting | Gray | • |

WEATHERPROOF BOXES & COVERS

WPG1 and WPG2 Thermoplastic/Heavy Cast Aluminum Covers

Two sizes: 1.96" and 2.32" diameters to cover 15A/20A Straight Blade and 15A/20A/30A Turnlok® devices. Covers fit all competitive flanged inlets and outlets.

Stainless steel mounting screws resist corrosion.

- A. Pre-attached gaskets** for easy installation and tight seal to panel or weatherproof box — with no misaligned or collapsed gaskets.
- B. Tamper-proof hinge** features permanent, locked-in pins for added security.
- C. Unbreakable glass-filled polycarbonate construction** withstands years of job site abuse and harsh environmental exposure. Stainless steel mounting screws resist corrosion.
- D. Molded-in label area** for pre-printed or handwritten labels identifying circuits, ratings, and other data.
- E. Lockable "bullnose"** for OSHA Lockout/Tagout compliance.

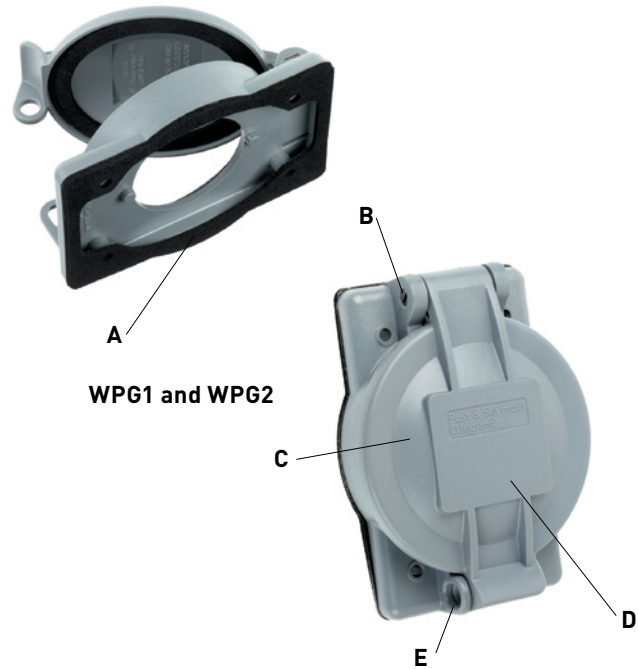

WPG1 and WPG2

WIUCED10SC Extra-Duty White-In-Use Cover

The NEC® Section 406.9(B)(1) requires that an outlet box load installed for this purpose shall be listed and shall be identified as "extra duty".

- A. Exclusive cord flap gasket** inhibits water splash from driving rain or sprinklers.
- B. Sturdy polycarbonate construction** resists impacts and harsh weather.
- C. Patented corner hinge and cord opening** allow vertical or horizontal installation.
- D. Exclusive WaterShed™ Channel** keeps water moving outside while cord flap keeps the inside dry.
- E. Preapplied gasket** easier to install, saves time, won't get lost or damaged.
- F. Paintable, textured finish** hides scratches.
- G. Patented trigger latch** opens easily with one finger, yet is lockable to prevent tampering.
- H. Sturdy, molded-in hinge** withstands hard use.
- I. Installs without removing electrical device**, thanks to patented, keyed mounting holes.
- J. Roomy interior** provides space for plugs and cord bends.

Shallow profile models have 1" shorter top lid than prior models.

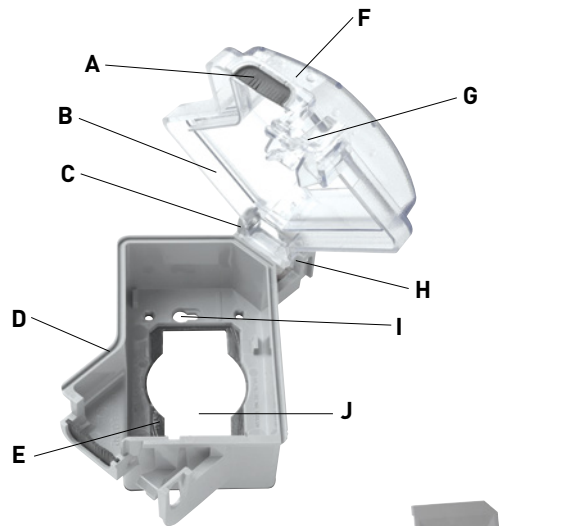

WIUCED10SC



Snap-in device plates require no tools to install and won't fall out. See chart for plates provided with each catalog number.





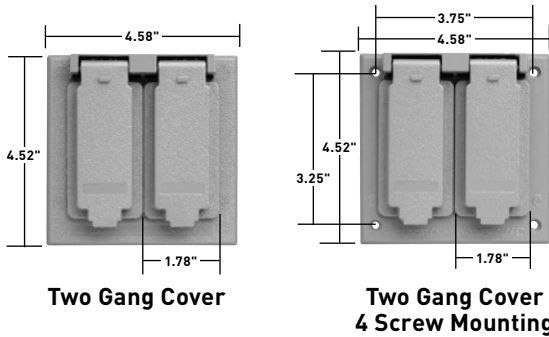







WEATHERPROOF BOXES & COVERS

Cast Weatherproof Covers



Features

- Broad line of two gang covers for switches, receptacles, GFCIs, and power outlets.
- Baked-on electrostatic, polyester, powder paint for superior scratch and corrosion resistance.
- Heavy-duty die-cast zinc.
- Stainless steel springs.
- All covers have 2 self-closing lids.
- Covers comply with NEC® Section 406.9(B)(1).

| CATALOG NUMBER | DESCRIPTION | COLOR | 3RD PARTY COMPLIANCE |
|-----------------|--|---------------|--|
| | | |  |
| TWO GANG | | | |
| CA82G CA82W |  2 Duplex Receptacles | Gray White | • |
| CA72G |  2 Single Receptacles | Gray | • |
| CA78G |  1 Single/1 Duplex 4 Screw Mounting | Gray | • |
| CA726G |  1 Single/1 Decorator 4 Screw Mounting | Gray | • |
| CA262G |  2 Decorator 4 Screw Mounting | Gray | • |
| CA268G |  1 Decorator/1 Duplex 4 Screw Mounting | Gray | • |
| CA17G |  1 Toggle/1 Single 4 Screw Mounting | Gray | • |
| CA18G |  1 Toggle/1 Duplex 4 Screw Mounting | Gray | • |
| CA126GRY |  1 Toggle/1 Decorator 4 Screw Mounting | Gray | • |
| CA2G CA2W |  2 Toggles 4 Screw Mounting | Gray White | • |
| CA2GS |  2 Toggles with 2 15A 120VAC Single Pole Toggle Switches (Cat. # 660) Included 4 Screw Mounting | Gray | • |