

Residential Loadcenters and Breaker Family



<b>1.1</b>	<b>Type CH Loadcenters and Circuit Breakers</b>	
	Overview .....	V1-T1-2
	Single-Phase .....	V1-T1-6
	Three-Phase .....	V1-T1-11
	CH Specialty Products .....	V1-T1-13
	Spa Panels .....	V1-T1-13
	Surge Panel .....	V1-T1-14
	Plug-On Neutral Loadcenter .....	V1-T1-16
	Type CH Renovation Loadcenter .....	V1-T1-17
	Type CH Retrofit Interior Kits .....	V1-T1-18
	Non-Metallic Loadcenter .....	V1-T1-20
	CH Loadcenter Options and Accessories .....	V1-T1-21
	CH Circuit Breakers .....	V1-T1-31
<b>1.2</b>	<b>Type BR Loadcenters and Circuit Breakers</b>	
	Overview .....	V1-T1-42
	Single-Phase .....	V1-T1-54
	Three-Phase .....	V1-T1-54
	BR Specialty Products .....	V1-T1-57
	BR Plug-On Neutral Loadcenters .....	V1-T1-57
	BR Quick Connect Neutral Loadcenters .....	V1-T1-60
	Spa Panels .....	V1-T1-61
	Riser Panel .....	V1-T1-62
	Type BR Renovation Loadcenter .....	V1-T1-63
	Type BR Retrofit Interior Kits .....	V1-T1-64
	BR Loadcenter Options and Accessories .....	V1-T1-66
	BR Circuit Breakers .....	V1-T1-80
<b>1.3</b>	<b>Loadcenter Interiors/OEM Loadcenters</b>	
	Product Description .....	V1-T1-92
	Standards and Certifications .....	V1-T1-93
	Product Selection .....	V1-T1-93
<b>1.4</b>	<b>Enclosed Breakers</b>	
	Product Description .....	V1-T1-97
	Standards and Certifications .....	V1-T1-97
	Product Selection .....	V1-T1-98
	Dimensions .....	V1-T1-98
<b>1.5</b>	<b>Classified Circuit Breakers</b>	
	Product Description .....	V1-T1-99
	Product Selection .....	V1-T1-100
	Accessories .....	V1-T1-102
	Technical Data .....	V1-T1-102
	Wiring Diagrams .....	V1-T1-103



# Revision notes

## Volume 1—Residential and Light Commercial, CA08100002E

Tab 1—Loadcenters and Circuit Breakers

Revision date	Section	Change page(s)	Description
09/25/2018	—	V1-T1-1	Tab TOC updates
09/25/2018	1.2	V1-T1-46, V1-T1-49	Content edits
09/25/2018	1.2	V1-T1-51	Content edits
09/25/2018	1.2	V1-T1-57	Insert new product
09/25/2018	1.2	V1-T1-58, V1-T1-59	Content edits
09/25/2018	1.2	V1-T1-73, V1-T1-74	Content edits
09/25/2018	1.4	V1-T1-95	Content edits



*Powering Business Worldwide*

Eaton Type CH Convertible Family



### Overview

#### Product Description

Loadcenters are enclosures specifically designed to house the branch circuit breakers and wiring required to distribute power to individual circuits. They contain either a main breaker when used at the service entrance point or a main lug when used as a sub-panel to add circuits to existing service. The main breaker protects the main entire panel and can be used as a service disconnect. The branch breakers protect the wires leading to individual electrical loads such as fixtures and outlets.

#### Features, Benefits and Functions

##### Loadcenter Construction

Eaton's Type CH loadcenters feature silver flash plated copper bus in all interiors. Stabs are rated 200 A throughout the CH line. Therefore, the sum of the handle ratings connected to any one stab is limited to 200 A maximum. NEMA 1 boxes are manufactured from cold rolled 16 gauge sheet steel. Raintight boxes are manufactured from galvanized steel. All boxes and trims are finished using an electrostatic powder coat, baked urethane paint process.

##### Neutrals

Eaton Type CH loadcenters feature two types of neutrals:

##### Insulated/Bondable Split Neutral

Panels are supplied with split insulated neutrals with an insulated cross strap. For service entrance applications, the neutral must be bonded by using the bonding strap supplied with the panel. For non-service entrance (sub-panel) applications, the panel may be installed with the bonding strap not connected to the neutral. Separate ground bars must be used on non-service entrance panels.

### Contents

<i>Description</i>	<i>Page</i>
Overview	
Standards and Certifications . . . . .	<b>V1-T1-3</b>
Catalog Number Selection . . . . .	<b>V1-T1-5</b>
Product Selection . . . . .	<b>V1-T1-6</b>
CH Specialty Products . . . . .	<b>V1-T1-13</b>
CH Loadcenter Options and Accessories . . . . .	<b>V1-T1-21</b>
CH Circuit Breakers . . . . .	<b>V1-T1-31</b>

##### Insulated/Bondable Single Neutral

Panels are supplied with a single insulated neutral. For service entrance applications, all that is required to bond the neutral is to loosen the bonding screw and the neutral screw directly beside it, insert the bonding strap into the neutral bar, and re-tighten both connections. The single neutral can be moved by the contractor to the other side of the panel, if desired. When used as a service entrance panel, unused neutral connections may be used for the termination of equipment grounds. For non-service entrance (sub-panel) applications, the panel may be installed with the bonding strap not connected to the neutral. Separate ground bars must be used on non-service entrance panels.

##### Inboard Plug-On Neutral

Code changes and higher safety standards are leading to more arc fault circuit interrupter (AFCI) installations. With the electrical contractor in mind, Eaton has revolutionized the way Combination AFCIs are installed with the Plug-on Neutral line of loadcenters and breakers.

This unique product solution enables the contractor to connect the breaker directly to the neutral bar, eliminating the need for wiring a pigtail.

##### Grounds

In service entrance applications where the neutral is bonded, unused neutral holes may be used for terminating ground conductors. In sub-feed panels, the neutral must be isolated (non-bonded), and ground wires must be terminated on a separate ground bar.

The insulated/bondable single/split neutral panels have sufficient terminations for both ground and neutral conductors. The insulated/bondable single split neutral panels are supplied with a separate factory-installed ground bar if the catalog number contains a "G." If not, a separate ground bar should be installed. Insulated/Bondable Single Neutral panels are supplied without a ground bar (unless otherwise noted), and ground bar kits, if needed, must be purchased separately.

**Neutral and Ground Terminals**

The standard terminals on grounds and neutrals are rated to accept (3)—#14—#10 Cu/Al or (1)—#14—4 wires. For larger cables, add-on neutral lugs may be ordered from the Accessories.

**Note:** NEC® allows only one current carrying conductor per hole on neutrals unless otherwise noted.

**Bottom-Fed Loadcenters**

When the power cable is brought into the loadcenter from below the panel; then the main lug panels, and single-phase, 225 A and below, loadcenters can be rotated 180 degrees to allow straight-in wiring of power cables to the main terminals. Because the CSR main circuit breaker handle operates horizontally, the orientation of the main circuit breaker handle is consistent with the requirements of NEC Article 240.81.

**Gutter Splicing**

Loadcenters are not UL listed as wiring troughs. Therefore, gutter splicing of riser cables to tap off to the main device is not permitted. Refer to NEC Article 373.8.

**Fire Rating**

Due to the numerous openings in both loadcenter boxes and trims, they should not be mounted in firewalls. There is no approval method for sealing the enclosures for this application.

**Date Code**

The date of manufacture of each loadcenter is printed on the outside of the carton as well as inside the loadcenter. On the carton, the date code is printed on the end carton label. In the loadcenter, the date code is located on the small white label located on the right side wall (with the main device on top).

The date code is in the following format: F # # # &. The “F” is the numeric code for the Lincoln, IL plant, and the three numbers are the year and week of manufacture, e.g., 023. The “&” sign at the end signifies the decade of the 2000s. The “!” at the end signifies the decade of the 2010s. Therefore, the date code F023& would indicate that the product was manufactured in the 23rd week of 2000. The 1980s are represented by a “+” sign and the 1990s are represented by a “=” at the end of the code.

**Plug-On Type CH Breakers**

Quick-make, quick-break switch mechanism combined with inverse time element tripping operation and trip-free handle design. Type CH circuit breakers trip to the OFF position eliminating nuisance callbacks. The thermal-magnetic trip curve avoids nuisance tripping on mild overloads while reacting almost instantaneously to severe short-circuit conditions. CHF breakers include a ‘trip flag’ to differentiate between a tripped breaker and one that has been turned off. Multipole breakers have internal common trip connection to operate all poles simultaneously. Handles are marked with ON-OFF indication and ampere rating of the breaker. Type CH breakers meet UL Standard 489, NEMA standards, and Federal Spec Classification W-C 375 b/Gen. They are UL listed under File Number E11713, E8741, E3624 and E51287; and CSA® certified file number LR87196, except Type CHT breakers.

**Type CH Circuit Breaker Ratings**

Single- and double-pole CH breakers rated 15 and 20 A have low instantaneous magnetic trip levels. The 15 and 20 A breakers with “HM” suffix have high magnetic trip settings recommended for circuits with inherently high inrush currents. All Type CH breakers are marked for heating, air conditioning and refrigeration (HACR) equipment application. Single-pole 15–20 A breakers are also suitable for switching duty (SWD). Shunt trip coils operate on 120 Vac and require one additional pole space per breaker.

**Standards and Certifications****UL® Listings**

All Eaton Type CH loadcenters are listed under the UL 67 certification in file E8741.



# 1.1

## Loadcenters and Circuit Breakers

### Type CH Loadcenters and Circuit Breakers

1

#### Type CH Loadcenter

Extra 1.5 inch Knockout (38.1 mm)

- Larger knockout provides easier installation and time savings for renovation installations

Top or Bottom Feed

- Straight-in wiring saves labor and material
- One panel for either top or bottom applications

2/0 Lug

- Easily removable and can be installed in any location on the neutral bar

Commercial Grade Main Breaker

- 25 kAIC series rated main breaker in 150 A–225 A loadcenters. 35, 42 and 100 kAIC series ratings are available
- Optional convertible design—reduces inventory requirements

One Piece Silver-Flashed Copper Bus

- Provides superior conductivity, corrosion resistance and durability

Drywall Marking on Enclosure

- Indicates proper mounting depth for flush applications

Steel Backpan

- Provides solid and reliable breaker mounting—single piece design for stability and durability

“Tangential” Center Knockout

- Easier installation for conduit applications

Unique Sandalwood Finish

- Aesthetically appealing, scratch-resistant powder coating

Neutral Bus (Strap)

- Easily removable for sub-panel applications

Bonding Z-Strap

- Provides easy field conversion for service entrance applications

Twin Neutral Bars

- Minimum 150% neutral capacity

Type CHF AFCI/GFCI/Thermal-Magnetic Breakers

- Advanced electronics effectively reduce nuisance tripping
- CHF AFCI breakers have a standard diagnostic LED indicating 1 of 7 trip codes
- Mechanical flag for trip indication (on thermal-magnetic AFCI and GFCI)
- All CH breakers provide industry exclusive 2-position handle with simple 1 step reset

Single Keyhole Mounting

- One keyhole at the top and bottom provides easier mounting and leveling

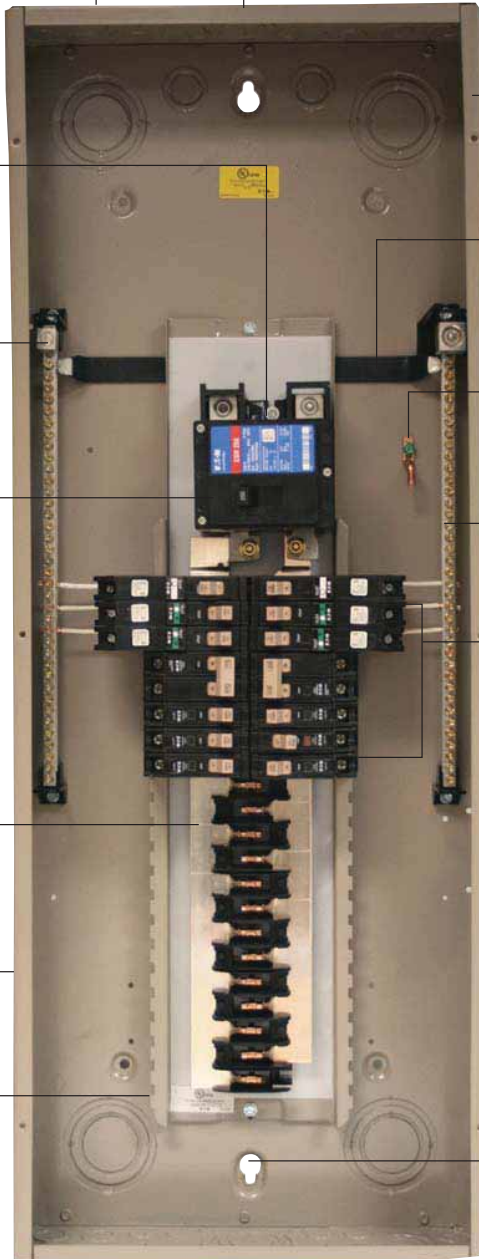

#### Warranty

The minimum warranty for residential loadcenters, breakers and surge protection devices shall be as follows:

- Lifetime loadcenter warranty
- Lifetime warranty on CH circuit breakers
- Lifetime warranty on CHSPT2ULTRA including \$75,000 connected equipment warranty
- 1-year warranty on plug-in surge protective device (CHSA)

### Catalog Number Selection

#### Loadcenters 100–225 A and 12–42 Circuits

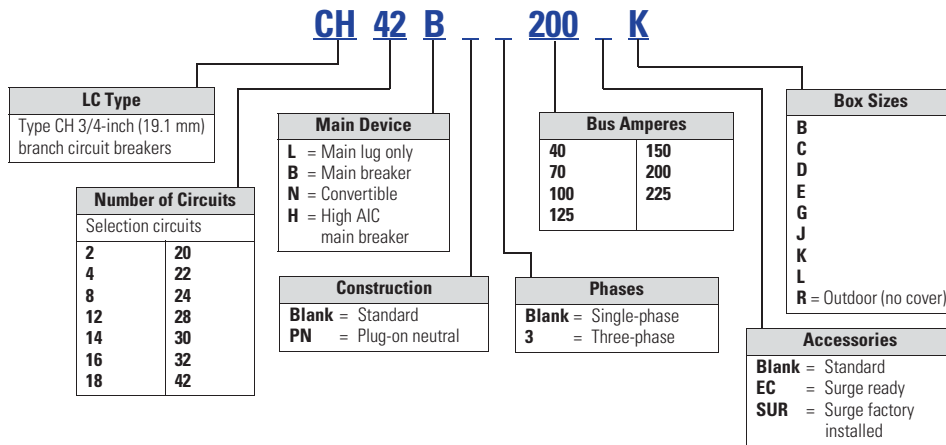

#### Indoor Covers Ordered Separately

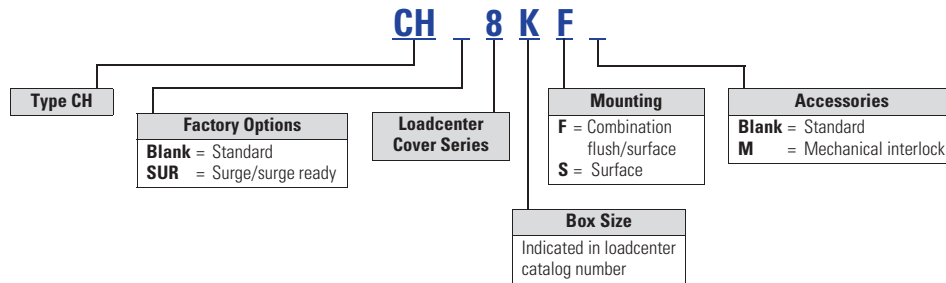

**Note:** All combinations are not valid, refer to the catalog section.

# 1.1

## Loadcenters and Circuit Breakers

### Type CH Loadcenters and Circuit Breakers

#### 1

#### Product Selection

#### Single-Phase—Main Circuit Breaker Loadcenters—10/25 kAIC

CH42B200K



#### Single-Phase Three-Wire—120/240 Vac—Insulated/Bondable Split Neutral (Unless Otherwise Noted)

Main Breaker Type	Main Ampere Rating	Maximum Number 3/4-Inch (19.1 mm) of Poles	Enclosure Type	Box Size	Wire Size Range Cu/Al 60 °C or 75 °C for Main Breaker	Loadcenter ①② Catalog Number	Loadcenter Cover Catalog Number	Combination ③	Surface	
CH 10 kAIC	100	14	Indoor	B	#6–1/0	CH14B100B ④	CH8BF	CH8BS		
		14	Outdoor	B	#6–1/0	CH14B100R ⑤	—	—		
		18	Indoor	C	#6–1/0	CH18B100C ④	CH8CF	CH8CS		
		18	Outdoor	C	#6–1/0	CH18B100R ⑤	—	—		
		22	Indoor	C	#6–1/0	CH22B100C ④	CH8CF	CH8CS		
		22	Outdoor	C	#6–1/0	CH22B100R ⑤	—	—		
		30	Indoor	D	#6–1/0	CH30B100D ④	CH8DF	CH8DS		
		30	Outdoor	D	#6–1/0	CH30B100R ⑤	—	—		
	125	22	Indoor	C	#6–1/0	CH22B125C ④	CH8CF	CH8CS		
		22	Outdoor	C	#6–1/0	CH22B125R ⑤	—	—		
		30	Indoor	D	#6–1/0	CH30B125D ④	CH8DF	CH8DS		
		30	Outdoor	D	#6–1/0	CH30B125R ⑤	—	—		
		CSR 25 kAIC	150	8	Outdoor	E	#2–300 kcmil	CH8B150RF ⑥	—	—
				24	Indoor	E	#2–300 kcmil	CH24B150C ④	CH8EF	CH8ES
24	Outdoor			E	#2–300 kcmil	CH24B150R ⑤	—	—		
32	Indoor			J	#2–300 kcmil	CH32B150J ④	CH8JF	CH8JS		
32	Outdoor			J	#2–300 kcmil	CH32B150R ⑤	—	—		
200	8		Outdoor	E	#2–300 kcmil	CH8B200RF ⑥	—	—		
	24		Indoor	E	#2–300 kcmil	CH24B200C ④	CH8EF	CH8ES		
	24		Outdoor	E	#2–300 kcmil	CH24B200R ⑤	—	—		
	32		Indoor	J	#2–300 kcmil	CH32B200J ④	CH8JF	CH8JS		
	32		Outdoor	J	#2–300 kcmil	CH32B200R ⑤	—	—		
225	42	Indoor	K	#2–300 kcmil	CH42B200K ④	CH8KF	CH8KS			
	42	Outdoor	K	#2–300 kcmil	CH42B200R ⑤	—	—			
	32	Indoor	J	#2–300 kcmil	CH32B225J ④	CH8JF	CH8JS			
	32	Outdoor	J	#2–300 kcmil	CH32B225R ⑤	—	—			
DK 10 kAIC	300	42	Indoor	PM	(2) 3/0–250 kcmil	CH42PM300	CH7PMF ⑦	CH7PMS		
		42	Indoor	PM	(2) 3/0–250 kcmil	CH42PM400	CH7PMF ⑦	CH7PMS		
	400	42	Indoor	PM	(2) 3/0–250 kcmil	CH42PM300	CH7PMF ⑦	CH7PMS		
		42	Indoor	PM	(2) 3/0–250 kcmil	CH42PM400	CH7PMF ⑦	CH7PMS		

#### Notes

- ① All main circuit breaker loadcenters are listed for use as service entrance equipment.
- ② Ground bar kits priced separately. See **Page V1-T1-24**.
- ③ Combination style covers may be used in surface or flush applications.
- ④ Can be top or bottom fed by rotating the enclosure and trim 180 degrees.
- ⑤ Rainproof panels are furnished with hub closure plates. For rainproof hubs, refer to **Page V1-T1-24**.
- ⑥ Panel includes #4–300 kcmil feed-through lugs.
- ⑦ This cover is for flush applications only (not combination).

Box sizes **Pages V1-T1-29** and **V1-T1-30**.

### Single-Phase—High Interrupting Rated Main Circuit Breaker Loadcenters—100 kAIC

#### Single-Phase Three-Wire—120/240 Vac—Insulated/Bondable Split Neutral

Main Breaker Type	Main Ampere Rating	Maximum Number 3/4-Inch (19.1 mm) Poles	Enclosure Type	Box Size	Wire Size Range Cu/Al 60 °C or 75 °C for Main Breaker	Loadcenter <sup>①</sup> Catalog Number	Loadcenter Cover Catalog Number Combination <sup>②</sup>	Surface
CHB4 100 kAIC <sup>⑤</sup>	100	32	Indoor	L	#6–1/0	CH32H100L <sup>③</sup>	CH8LF	CH8LS
		32	Outdoor	L	#6–1/0	CH32H100R <sup>④</sup>	—	—
CHH 100 kAIC <sup>⑤</sup>	150	32	Indoor	L	#2/0–300 kcmil	CH32H150L	CH8LF	CH8LS
		32	Outdoor	L	#2/0–300 kcmil	CH32H150R <sup>④</sup>	—	—
	200	32	Indoor	L	#2/0–300 kcmil	CH32H200L	CH8LF	CH8LS
		32	Outdoor	L	#2/0–300 kcmil	CH32H200R <sup>④</sup>	—	—
		42	Indoor	L	#2/0–300 kcmil	CH42H200L	CH8LF	CH8LS
		42	Outdoor	L	#2/0–300 kcmil	CH42H200R <sup>④</sup>	—	—
	225	42	Indoor	L	#2/0–300 kcmil	CH42H225L	CH8LF	CH8LS
		42	Outdoor	L	#2/0–300 kcmil	CH42H225R <sup>④</sup>	—	—

#### Notes

- ① All main circuit breaker loadcenters are listed for use as service entrance equipment.
- ② Combination style covers may be used in surface or flush applications.
- ③ Loadcenter can be top or bottom fed by rotating the enclosure and trim 180 degrees.
- ④ Rainproof panels are furnished with hub closure plates. For rainproof hubs, refer to **Page V1-T1-24**.
- ⑤ Series rated for 100 kAIC with all Types CH, CHT and CHP breakers.



# 1.1





## Loadcenters and Circuit Breakers

### Type CH Loadcenters and Circuit Breakers

1

#### Single-Phase—Main Lug Loadcenters

#### Single-Phase Three-Wire—120/240 Vac—Insulated/Bondable Single Neutral

Main Ampere Rating	Maximum Number 3/4-Inch (19.1 mm)		Enclosure Type	Type of Trim (Included)	Box Size	Wire Size Range Cu/Al 60 °C or 75 °C for Main Lugs	Loadcenter Catalog Number
	Space	Poles					
<b>Surface Outdoor</b> 	2	4 ①	Indoor	Surface (no door)	5	#14–6	<b>CH2L40SP</b> ②③
	2	4 ①	Outdoor	—	5R	#14–6	<b>CH2L40RP</b> ②③④
	2	4 ①	Indoor	Flush (no door)	5	#14–6	<b>CH2L40FP</b> ②③
<b>Flush Outdoor</b> 	2	4 ①	Indoor	Surface (no door)	5	#14–2	<b>CH2L70SP</b> ②③
	2	4 ①	Outdoor	—	5R	#14–2	<b>CH2L70RP</b> ②③④
	2	4 ①	Indoor	Flush (no door)	5	#14–2	<b>CH2L70FP</b> ②③
<b>Surface (No Door)</b> 	2	4 ①	Indoor	Surface (no door)	6	#14–1/0	<b>CH2L125SP</b> ②③
	2	4 ①	Outdoor	—	6R	#14–1/0	<b>CH2L125RP</b> ②③④
	2	2	Outdoor	—	—	#14–1/0	<b>CH2L125RSE2P</b> ④⑤⑥
	2	4 ①	Indoor	Flush (no door)	6	#14–1/0	<b>CH2L125FP</b> ②③
	4	8 ①	Indoor	Surface (no door)	7	#14–1/0	<b>CH4L125SP</b> ②⑦
	4	8 ①	Outdoor	—	7R	#14–1/0	<b>CH4L125RP</b> ②④⑦
	4	8 ①	Indoor	Flush (no door)	7	#14–1/0	<b>CH4L125FP</b> ②⑦
	6	12 ①	Outdoor	—	6R	#14–1/0	<b>CH6L125R</b> ②⑥⑦
	8	16 ①	Indoor	Surface (no door)	7	#6–1/0	<b>CH8L125SP</b> ②⑧
	8	16 ①	Outdoor	—	7R	#6–1/0	<b>CH8L125RP</b> ②⑥⑦
<b>Flush (No Door)</b> 	8	16 ①	Indoor	Flush (no door)	7	#6–1/0	<b>CH8L125FP</b> ②⑥
	8	16 ①	Indoor	Flush (no door)	7	#6–1/0	<b>CH8L125FP</b> ②⑥
<b>Outdoor</b> 	2	4 ①	Indoor	Surface (no door)	6	#14–1/0	<b>CH2L125SP</b> ②③
	2	4 ①	Outdoor	—	6R	#14–1/0	<b>CH2L125RP</b> ②③④

#### Notes

- ① Requires the use of Type CHT breakers.
- ② Ground bar kits priced separately, see **Page V1-T1-24**.
  - For 2/4 and 6/12 circuit loadcenters, use Type GBK5 or GBK520 ground bar
  - For 4/8 and 8/16 circuit loadcenters, use Type GBK10 ground bar
  - Ground bars mount to the left side wall of the enclosure for the 4/8, 6/12 and 8/16 circuit loadcenters
- ③ Suitable for use as service equipment when not more than two service disconnecting mains are provided or when not used as a lighting and appliance panelboard.
- ④ Rainproof panels are furnished with hub closure plates. For rainproof hubs, refer to **Page V1-T1-24**.
- ⑤ For use as service entrance applications only.
- ⑥ Neutral/ground holes (6) #14–6 and (3) #14–2/0 AWG Cu/Al.
- ⑦ Suitable for use as service equipment when not more than two service disconnecting mains are provided or when not more than six service disconnecting mains are provided and when not used as a lighting and appliance panelboard.
- ⑧ Suitable for use as service equipment when a main breaker is used or when not more than six service disconnecting mains are provided and when not used as a lighting and appliance panelboard.

Box sizes **Pages V1-T1-29 and V1-T1-30**.

CH42L225G



### Single-Phase Three-Wire—120/240 Vac—Insulated/Bondable Split Neutral—Factory-Installed Ground Bar

Main Ampere Rating	Maximum Number 3/4-Inch (19.1 mm) Poles	Enclosure Type	Box Size	Wire Size Range Cu/Al 60 °C or 75 °C for Main Lugs	Loadcenter Catalog Number	Loadcenter Cover	
						Catalog Number	Combination Surface
125	12	Indoor	B	#6–2/0	CH12L125B <sup>①</sup>	CH8BF	CH8BS
	12	Outdoor	B	#6–2/0	CH12L125R <sup>①②</sup>	—	—
	16	Indoor	B	#6–2/0	CH16L125B <sup>①</sup>	CH8BF	CH8BS
	16	Outdoor	B	#6–2/0	CH16L125R <sup>①②</sup>	—	—
	20	Indoor	C	#6–2/0	CH20L125C <sup>①</sup>	CH8CF	CH8CS
	20	Outdoor	C	#6–2/0	CH20L125R <sup>①②</sup>	—	—
	24	Indoor	C	#6–2/0	CH24L125C <sup>①</sup>	CH8CF	CH8CS
	24	Outdoor	C	#6–2/0	CH24L125R <sup>①②</sup>	—	—
150	24	Indoor	D	#4–300 kcmil	CH24L150D <sup>①</sup>	CH8DF	CH8DS
	24	Outdoor	D	#4–300 kcmil	CH24L150R <sup>②③</sup>	—	—
	32	Indoor	D	#4–300 kcmil	CH32L150D <sup>①</sup>	CH8DF	CH8DS
	32	Outdoor	D	#4–300 kcmil	CH32L150R <sup>②③</sup>	—	—
200	12	Indoor	D	#4–300 kcmil	CH12L200D <sup>①</sup>	CH8DF	CH8DS
	12	Outdoor	D	#4–300 kcmil	CH12L200R <sup>②③</sup>	—	—
	16	Indoor	D	#4–300 kcmil	CH16L200D <sup>①</sup>	CH8DF	CH8DS
	16	Outdoor	D	#4–300 kcmil	CH16L200R <sup>②③</sup>	—	—
225	24	Indoor	D	#4–300 kcmil	CH24L225D <sup>①</sup>	CH8DF	CH8DS
	24	Outdoor	D	#4–300 kcmil	CH24L225R <sup>②③</sup>	—	—
	32	Indoor	D	#4–300 kcmil	CH32L225D <sup>①</sup>	CH8DF	CH8DS
	32	Outdoor	D	#4–300 kcmil	CH32L225R <sup>②③</sup>	—	—
	42	Indoor	G	#4–300 kcmil	CH42L225G <sup>③</sup>	CH8GF	CH8GS
	42	Outdoor	G	#4–300 kcmil	CH42L225R <sup>②③</sup>	—	—
400	42	Indoor	P	(2) 1/0–300 kcmil (1) 750 kcmil	CH42PL400 <sup>④</sup>	CH7PF <sup>⑤</sup>	CH7PS

**Notes**

- ① Suitable for use as service equipment when not more than six disconnecting means are provided and when not used as a lighting and appliance panelboard.
- ② Rainproof panels are furnished with hub closure plates. For rainproof hubs, refer to **Page V1-T1-24**.
- ③ Suitable for use as service equipment when a circuit breaker is used as a main breaker. The main breaker is backfed and requires hold-down bracket kit catalog number **CH125RB**.
- ④ Suitable for use as service equipment when a circuit breaker is used as a main breaker. The main breaker is backfed and must be a Type CHB.  
**The breaker cannot be a Type CH.**
- ⑤ This cover is for flush application only (not combination).

Box sizes **Pages V1-T1-29** and **V1-T1-30**.

# 1.1

## Loadcenters and Circuit Breakers

### Type CH Loadcenters and Circuit Breakers

1

#### Convertible Loadcenters MCB or MLO—Base Units and Main Devices—10/25/35 kAIC

Complete assembly consists of: loadcenter, cover, and either main breaker kit or main lug kit.

#### Indoor—Single-Phase—Three-Wire—120/240 V—Insulated/Bondable Split Neutral—Top or Bottom Feed

Maximum Main Ampere Rating	Maximum Number of Single Poles	Box Size	Loadcenter Box and Panel Catalog Number ①	Loadcenter Cover Catalog Number		Main Lug Kit		Main Breaker Kit		Catalog Number	
				Combination	Surface	Wire Size	Catalog Number	kAIC Rating	Wire Size		
125	22	C	CH22N125C	CH8CF	CH8CS	#10–1/0	CHL125N	10	#10–1/0	CH2100N ③	—
										CH2125N ③	—
200	32	J	CH32N200J	CH8JF	CH8JS	#4–300 kcmil	CHL225N	25/35 ②	#2–300 kcmil	CSR2125N	CSH2125N ④
										CSR2150N	CSH2150N ④
										CSR2175N	CSH2175N ④
										CSR2200N	CSH2200N ④
225	42	K	CH42N225K	CH8KF	CH8KS	#4–300 kcmil	CHL225N	25/35 ②	#2–300 kcmil	CSR2125N	CSH2125N ④
										CSR2150N	CSH2150N ④
										CSR2175N	CSH2175N ④
										CSR2200N	CSH2200N ④
										CSR2225N	CSH2225N ④

#### Outdoor—Single-Phase—Three-Wire—120/240 V—Insulated/Bondable Split Neutral (Unless Otherwise Noted)

Maximum Main Ampere Rating	Maximum Number of Single Poles	Box Size	Loadcenter Box and Panel Catalog Number ①	Main Lug Kit		Main Breaker Kit		Catalog Number	
				Wire Size	Catalog Number	kAIC Rating	Wire Size		
125	22	C	CH22N125R ⑤	#10–1/0	CHL125N	10	#10–1/0	CH2100N ③	—
								CH2125N ③	—
200	8	E	CH8N200RF ⑥⑦	#4–300 kcmil	CHL225N	25/35 ②	#2–300 kcmil	CSR2125N	CSH2125N
								CSR2150N	CSH2150N
								CSR2175N	CSH2175N
								CSR2200N	CSH2200N
200	32	J	CH32N200R ⑤	#4–300 kcmil	CHL225N	25/35 ②	#2–300 kcmil	CSR2125N	CSH2125N ④
								CSR2150N	CSH2150N ④
								CSR2175N	CSH2175N ④
								CSR2200N	CSH2200N ④
225	42	K	CH42N225R ⑤	#4–300 kcmil	CHL225N	25/35 ②	#2–300 kcmil	CSR2125N	CSH2125N ④
								CSR2150N	CSH2150N ④
								CSR2175N	CSH2175N ④
								CSR2200N	CSH2200N ④
								CSR2225N	CSH2225N ④

#### Notes

- ① Panel does not include main. Order main breaker or main lug kit separately.
- ② If 35 kAIC is required, use CSH breaker.
- ③ Hold-down kit included.
- ④ 35 kAIC series combination rating is obtained when Types CH, CHT and CHP branch breakers are used with CSH main.
- ⑤ Rainproof panels are furnished with hub closure plates. For rainproof hubs, refer to **Page V1-T1-24**.
- ⑥ Includes feed-through lugs for both phase and neutral conductors.
- ⑦ Insulated/bondable single neutral.

Interrupting rating depends on main circuit breaker selected.

### Three-Phase—Main Circuit Breaker Loadcenters—10 kAIC

CH42B3200L



#### Three-Phase Four-Wire—208Y/120 Vac or 240 Vac Insulated/Bondable Split Neutral

Main Breaker Type	Main Ampere Rating	Maximum Number 3/4-Inch (19.1 mm) Poles	Enclosure Type	Box Size	Wire Size Range Cu/Al 60 °C or 75 °C for Main Breaker	Loadcenter Catalog Number <sup>①②</sup>	Loadcenter Cover Catalog Number	
							Combination	Surface
CC 10 kAIC	150	30	Indoor	L	#1–4/0	CH30B3150L	CH8LF	CH8LS
			Outdoor	L	#1–4/0	CH30B3150R <sup>③</sup>	—	—
	200	30	Indoor	L	#2/0–300 kcmil	CH30B3200L	CH8LF	CH8LS
			Outdoor	L	#2/0–300 kcmil	CH30B3200R <sup>③</sup>	—	—
		42	Indoor	L	#2/0–300 kcmil	CH42B3200L	CH8LF	CH8LS
			Outdoor	L	#2/0–300 kcmil	CH42B3200R <sup>③</sup>	—	—
	225	30	Indoor	L	#2/0–300 kcmil	CH30B3225L	CH8LF	CH8LS
			Outdoor	L	#2/0–300 kcmil	CH30B3225R <sup>③</sup>	—	—
		42	Indoor	L	#2/0–300 kcmil	CH42B3225L	CH8LF	CH8LS
			Outdoor	L	#2/0–300 kcmil	CH42B3225R <sup>③</sup>	—	—
	400	42	Indoor	PM	(2) 3/0–350 kcmil	CH424PM400	CH7PMF <sup>④</sup>	CH7PMS

### Three-Phase—High Interrupting Rated Main Circuit Breaker Loadcenters—100 kAIC

#### Three-Phase Four-Wire—208Y/120 Vac or 240 Vac Insulated/Bondable Split Neutral

Main Breaker Type	Main Ampere Rating	Maximum Number 3/4-Inch (19.1 mm) of Poles	Enclosure Type	Box Size	Wire Size Range Cu/Al 60 °C or 75 °C for Main Breaker	Loadcenter Catalog Number <sup>①②</sup>	Loadcenter Cover Catalog Number	
							Combination	Surface
CHH 100 kAIC <sup>⑤</sup>	200	30	Indoor	L	#2/0–300 kcmil	CH30H3200L	CH8LF	CH8LS
			Outdoor	L	#2/0–300 kcmil	CH30H3200R <sup>③</sup>	—	—
		42	Indoor	L	#2/0–300 kcmil	CH42H3200L	CH8LF	CH8LS
			Outdoor	L	#2/0–300 kcmil	CH42H3200R <sup>③</sup>	—	—
	225	42	Indoor	L	#2/0–300 kcmil	CH42H3225L	CH8LF	CH8LS
			Outdoor	L	#2/0–300 kcmil	CH42H3225R <sup>③</sup>	—	—

#### Notes

- ① All main circuit breaker loadcenters are listed for use as service entrance equipment.
- ② Ground bar kits priced separately. For ground bar kits, see **Page V1-T1-24**.
- ③ Rainproof loadcenters are furnished with hub closure plates. For rainproof hubs, refer to **Page V1-T1-24**.
- ④ This cover for flush application only (not combination).
- ⑤ 100 kAIC series combination rating is obtained when Types CH and CHP branch breakers are used with CHH main.

# 1.1

## Loadcenters and Circuit Breakers

### Type CH Loadcenters and Circuit Breakers

1

#### Three-Phase—Main Lug Loadcenters

#### Three-Phase Four-Wire—208Y/120 Vac or 240 Vac Insulated/Bondable Split Neutral (Unless Otherwise Noted)

Main Ampere Rating	Maximum Number 3/4-Inch (19.1 mm)		Enclosure Type	Type of Trim Included	Box Size	Wire Size Range Cu/Al 60 °C or 75 °C for Main Lugs	Loadcenter Catalog Number	Loadcenter Cover Catalog Number	
	Spaces	Poles						Combination	Single
125	6	12 <sup>①</sup>	Indoor	Surface, no door	7	#14–1/0	CH6L3125SP <sup>②③④</sup>	—	—
	6	12 <sup>①</sup>	Outdoor	—	7R	#14–1/0	CH6L3125RP <sup>②③④⑤</sup>	—	—
	6	12 <sup>①</sup>	Indoor	Flush, no door	7	#14–1/0	CH6L3125FP <sup>②③④</sup>	—	—
	12	12	Indoor	—	B	#6–2/0	CH12L3125B <sup>⑥⑦</sup>	CH8BF	CH8BS
	12	12	Outdoor	—	B	#6–2/0	CH12L3125R <sup>⑥⑥⑦</sup>	—	—
	18	18	Indoor	—	C	#6–2/0	CH18L3125C <sup>⑥⑦</sup>	CH8CF	CH8CS
	18	18	Outdoor	—	C	#6–2/0	CH18L3125R <sup>⑥⑦⑧</sup>	—	—
	24	24	Indoor	—	C	#6–2/0	CH24L3125C <sup>⑥⑦</sup>	CH8CF	CH8CS
150	30	30	Indoor	—	D	#4–300 kcmil	CH30L3150D <sup>⑥⑦</sup>	CH8DF	CH8DS
	30	30	Outdoor	—	D	#4–300 kcmil	CH30L3150R <sup>⑥⑥⑨</sup>	—	—
225	24	24	Indoor	—	D	#4–300 kcmil	CH24L3225D <sup>⑥⑦</sup>	CH8DF	CH8DS
	24	24	Outdoor	—	D	#4–300 kcmil	CH24L3225R <sup>⑥⑥⑨</sup>	—	—
	30	30	Indoor	—	D	#4–300 kcmil	CH30L3225D <sup>⑥⑦</sup>	CH8DF	CH8DS
	30	30	Outdoor	—	D	#4–300 kcmil	CH30L3225R <sup>⑥⑥⑨</sup>	—	—
	42	42	Indoor	—	G	#4–300 kcmil	CH42L3225G <sup>⑥⑨</sup>	CH8GF	CH8GS
	42	42	Outdoor	—	G	#4–300 kcmil	CH42L3225R <sup>⑥⑥⑨</sup>	—	—
400	42	42	Indoor	—	P	(2) 1/0–300 kcmil (1) 750 kcmil	CH424PL400 <sup>⑩⑪</sup>	CH7PF <sup>⑫</sup>	CH7PS

#### Notes

- ① Requires the use of Type CHT breakers.
- ② Suitable for use as service equipment when not more than two service disconnecting means are provided or when not more than six service disconnecting means are provided and when not used as a lighting and appliance panelboard.
- ③ Ground bar kits priced separately, see **Page V1-T1-24**.
  - Use GBK10 ground bar
  - Ground bars mount to the left side wall of the enclosure.
- ④ Insulated/bondable single neutral.
- ⑤ Rainproof loadcenters are furnished with hub closure plates. For rainproof hubs, refer to **Page V1-T1-24**.
- ⑥ Ground bar Type GBK14 is installed.
- ⑦ Suitable for use as service equipment when a circuit breaker is used as a main breaker. The main breaker is backfed and requires hold-down bracket kit catalog number Type **CH125RB**. Suitable for use as service equipment when not more than six service disconnecting means are provided and when not used as a lighting and appliance panelboard.
- ⑧ Ground bar Type GBK21 is installed.
- ⑨ Suitable for use as service equipment when a circuit breaker is used as a main breaker. The main breaker is backfed and requires hold-down kit catalog number Type **CH125RB**.
- ⑩ For ground bar kits, see **Page V1-T1-24**.
- ⑪ Suitable for use as service equipment when a circuit breaker is used as a main breaker. The main breaker is backfed and must be a Type CHB. **The breaker cannot be a Type CH.**
- ⑫ This cover for flush application only (not combination).

Box sizes **Pages V1-T1-29** and **V1-T1-30**.

### Spa Panels



### Contents

Description	Page
Overview	V1-T1-2
CH Specialty Products	
Spa Panels	
Surge Panel	V1-T1-14
Plug-On Neutral Loadcenter	V1-T1-16
Type CH Renovation Loadcenter	V1-T1-17
Type CH Retrofit Interior Kits	V1-T1-18
CH Loadcenter Options and Accessories	V1-T1-21
CH Circuit Breakers	V1-T1-31

## CH Specialty Products

### Spa Panels

#### Product Description

Eaton's CH Spa Panels are premium factory-assembled "combination" units that provide ground fault protection, as well as a convenient way to turn spa pumps on and off. The NEC requires that all pool and spa pumps be protected by a ground fault interrupter and a disconnect switch mounted within 10 feet of the tub or the spa.

#### Features

- Two extra circuits for additional loads
- Limited lifetime warranty
- UL Listed
- Tough powder-coated galvanized steel enclosure
- Factory-installed two-pole ground fault circuit interrupter (GFCI)

#### Product Selection

##### CH Spa Panel



#### Single-Phase Three-Wire—120/240 Vac Insulated/Bondable Neutral—Factory-Installed Ground Bar

Main Ampere Rating	Circuit Breaker Included	Enclosure Type	Type of Trim Included	Box Size	Wire Size Range Cu/Al 60 °C or 75 °C for Main Lugs	Catalog Number
30	CH230GFT	Outdoor	—	5R	#14–1/0	CH30SPAST <sup>①</sup>
40	CH240GFT	Outdoor	—	5R	#14–1/0	CH40SPAST <sup>②</sup>
50	CH250GFT	Outdoor	—	5R	#14–1/0	CH50SPAST <sup>③</sup>
60	CH260GFT	Outdoor	—	5R	#14–1/0	CH60SPAST <sup>④</sup>

#### Notes

- ① Includes a CH230GFT breaker, factory installed, and two extra circuits for convenience.
- ② Includes a CH240GFT breaker, factory installed, and two extra circuits for convenience.
- ③ Includes a CH250GFT breaker, factory installed, and two extra circuits for convenience.
- ④ Includes a CH260GFT breaker, factory installed, and two extra circuits for convenience.

Surge Panel



### Contents

<i>Description</i>	<i>Page</i>
Overview . . . . .	V1-T1-2
CH Specialty Products	
Spa Panels . . . . .	V1-T1-13
Surge Panel	
Plug-On Neutral Loadcenter . . . . .	V1-T1-16
Type CH Renovation Loadcenter. . . . .	V1-T1-17
Type CH Retrofit Interior Kits . . . . .	V1-T1-18
CH Loadcenter Options and Accessories . . . . .	V1-T1-21
CH Circuit Breakers . . . . .	V1-T1-31

### Surge Panel

#### Product Description

Eaton's Type CH Surge Loadcenter includes a factory-mounted and wired surge suppressor device. There is a knockout in the cover that allows the user to view the status indication lights on the surge suppressor. The CH Surge Loadcenter reduces the surge current, helping protect sensitive home electronic equipment.

Save labor by installing a factory-mounted surge protective device.

#### Factory-Installed Surge Protection

- Includes a CHSPT2ULTRA and a two-pole 50 A circuit breaker
- Increases the effectiveness of surge protection due to reduced lead length
- A modified deadfront allows for easy viewing of indicating lights

#### Surge Ready

- Provides a mounting provision for CHSPT2ULTRA
- A modified deadfront allows for easy viewing of indicating lights

#### Product Selection

##### Surge Installed Loadcenters

Ampere Rating	Type	Number of Circuits	Loadcenter Catalog Number	Loadcenter Cover	
				Catalog Number	Surface
225	Convertible	42	CHSUR42N225L ①	CHSUR8LF	CHSUR8LS
225	Convertible ②	42	CHSUR42L225L2 ①	CHSUR8LF	CHSUR8LS
200	Main breaker	42	CHSUR42B200L2 ①	CHSUR8LF	CHSUR8LS
225	Convertible	32	CHSUR32N225K ①	CHSUR8KF	CHSUR8KS
225	Convertible ②	32	CHSUR32L225K ①	CHSUR8KF	CHSUR8KS
200	Main breaker	32	CHSUR32B200K ①	CHSUR8KF	CHSUR8KS
150	Main breaker	32	CHSUR32B150K ①	CHSUR8KF	CHSUR8KS
100	Main breaker	32	CHSUR32B100K ①	CHSUR8KF	CHSUR8KS
125	Convertible ②	24	CHSUR24L125E ①	CHSUR8EF	CHSUR8ES
100	Main breaker	24	CHSUR24B100E ①	CHSUR8EF	CHSUR8ES
200	Convertible	40/40	BRSUR4040N200	Cover included	
200	Main lug	40/40	BRSUR4040L200	Cover included	
200	Main breaker	40/40	BRSUR4040B200	Cover included	
200	Convertible	30/40	BRSUR3040N200	Cover included	
200	Main lug	30/40	BRSUR3040L200	Cover included	
200	Main breaker	30/40	BRSUR3040B200	Cover included	

#### Notes

- ① Order cover separately.
- ② With main lugs installed.

### Surge Ready Loadcenters (provision only, CHSPT2ULTRA and breaker not included)

Ampere Rating	Type	Number of Circuits	Loadcenter Catalog Number <sup>①</sup>	Loadcenter Cover Catalog Number Combination	Loadcenter Cover Catalog Number Surface
225	Convertible	42	CHEC42N225L	CHSUR8LF	CHSUR8LS
225	Convertible <sup>②</sup>	42	CHEC42L225L	CHSUR8LF	CHSUR8LS
200	Main breaker	42	CHEC42B200L	CHSUR8LF	CHSUR8LS
225	Convertible <sup>②</sup>	32	CHEC32L225K	CHSUR8KF	CHSUR8KS
225	Convertible	32	CHEC32N225K	CHSUR8KF	CHSUR8KS
225	Convertible	32	CHEC32N225R <sup>③</sup>	—	—
200	Main breaker	32	CHEC32B200K	CHSUR8KF	CHSUR8KS
150	Main breaker	32	CHEC32B150K	CHSUR8KF	CHSUR8KS
100	Main breaker	32	CHEC32B100K	CHSUR8KF	CHSUR8KS
125	Convertible <sup>②</sup>	24	CHEC24L125E	CHSUR8EF	CHSUR8ES
100	Main breaker	24	CHEC24B100E	CHSUR8EF	CHSUR8ES

### Technical Data and Specifications

#### Ratings

- Loadcenter
  - 25 kAIC main breaker, main lug only, and convertible main breaker/main lug
  - Factory installed or provision for field-installed surge suppressor
  - Top or bottom feed
- Surge protective device (CHSPT2ULTRA)
  - Nominal discharge current: 20 kA ( $I_n$ )
  - Surge current capacity per phase: 108 kA
  - Warranty: \$75,000 connected equipment <sup>④</sup>
  - For further product ratings, see Volume 1, Tab 2.1 Surge Protection

#### Notes

- ① Order cover separately.
- ② With main lugs installed.
- ③ Rainproof loadcenters are furnished with hub closure plates. For rainproof hubs, refer to **Page V1-T1-24**.
- ④ For warranty details, visit [www.eaton.com/surgetrap](http://www.eaton.com/surgetrap).



#### 60-Circuit Plug-On Neutral Loadcenter



### Plug-On Neutral Loadcenter

#### Product Description

Code changes and higher safety standards are leading to more arc fault and ground fault circuit interrupter installations. Eaton offers a unique product solution that enables a direct connection of the breaker to the neutral bar, eliminating the need for wiring a pigtail.

#### Features and Benefits

- Time savings up to 25% per AFCI/GFCI installation
- Eliminates nuisance tripping due to loose pigtail connections
- Clean gutter space
- Easier troubleshooting due to less wiring
- Backed by a limited lifetime warranty

### Contents

<i>Description</i>	<i>Page</i>
Overview	V1-T1-2
CH Specialty Products	
Spa Panels	V1-T1-13
Surge Panel	V1-T1-14
Plug-On Neutral Loadcenter	
Type CH Renovation Loadcenter	V1-T1-17
Type CH Retrofit Interior Kits	V1-T1-18
CH Loadcenter Options and Accessories	V1-T1-21
CH Circuit Breakers	V1-T1-31

### Product Selection

#### Main Breaker Plug-On Neutral Loadcenters

Main Breaker Type	Main Ampere Rating	Max. Number 3/4-Inch Poles	Enclosure Type	Wire Size Range for Main Breaker	Catalog Number	Cover Catalog Number	
						Combination	Surface
CSR 25 kAIC	100	24	Indoor	#2–300 kcmil	CH24BPN100E	CH8EF	CH8ES
	200	32	Indoor	#2–300 kcmil	CH32BPN200J	CH8JF	CH8JS
	200	42	Indoor	#2–300 kcmil	CH42BPN200K	CH8KF	CH8KS
	200	60	Indoor	#2–300 kcmil	CH60BPN200N	CH8NF	CH8NS

#### Main Lug Only/Convertible Plug-On Neutral Loadcenters—With Factory Installed Main Lugs

Max. Ampere Rating	Max. Number 3/4-Inch Poles	Enclosure Type	Catalog Number	Wire Size Range for Main Breaker	Cover Catalog Number	
					Combination	Surface
125	24	Indoor	CH24NLPN125E <sup>①</sup>	#6–300 kcmil	CH8NLEF	CH8NLES
225	32	Indoor	CH32NLPN225J	#6–300 kcmil	CH8NLJF	CH8NLJS
225	42	Indoor	CH42NLPN225K	#6–300 kcmil	CH8NLKF	CH8NLKS
225	60	Indoor	CH60NLPN225N	#6–300 kcmil	CH8NLNF	—

#### Note

<sup>①</sup> Maximum 125 A main device.

Renovation Panel



### Contents

<i>Description</i>	<i>Page</i>
Overview . . . . .	V1-T1-2
CH Specialty Products	
Spa Panels . . . . .	V1-T1-13
Surge Panel . . . . .	V1-T1-14
Plug-On Neutral Loadcenter . . . . .	V1-T1-16
Type CH Renovation Loadcenter	
Type CH Retrofit Interior Kits . . . . .	V1-T1-18
CH Loadcenter Options and Accessories . . . . .	V1-T1-21
CH Circuit Breakers . . . . .	V1-T1-31

## Type CH Renovation Loadcenter

### Product Description

Eaton's Renovation Loadcenter is designed for the service contractor. With the addition of a five-circuit terminal block factory mounted in the top left corner of the loadcenter, the service contractor can terminate short-circuit wires instead of having to use expensive wire nuts. Also, the Renovation Loadcenter incorporates a twin-stacked neutral design that places the neutral and ground terminations higher in the loadcenter. Both of these features were added without increasing any size from a standard loadcenter. These features will eliminate the need for wire nuts and make for a much neater installation. There is a provision to field mount a second five-circuit terminal block (RN5TB) in the top right corner of the loadcenter. Choose amongst Eaton's Type CH breaker family for use in the Renovation Panel.

### Product Selection

#### Single-Phase—Main Circuit Breaker Loadcenters 25 kAIC<sup>①</sup>

#### Single-Phase, Three-Wire—120/240 Vac—Stacked Split Neutral

Main Breaker Type	Main Ampere Rating	Max. Number 3/4-Inch (19.1 mm) of Poles	Enclosure Type	Box Size	Wire Size Range Cu/Al 60 °C or 70 °C for Main Breakers	Loadcenter Catalog Number	Cover Catalog Number <sup>②</sup>	
							Combination	Surface
CH	100	20	Indoor	C	#6–1/0	CH22B100CRN	CH8CFF	CH8CS
CSR	150	32	Indoor	J	#2–300 kcmil	CH32B150JRN	CH8JF	CH8JS
CSR	200	32	Indoor	J	#2–300 kcmil	CH32B200JRN	CH8J	CH8JS
CSR	200	42	Indoor	K	#2–300 kcmil	CH42B200KRN	CH8KF	CH8KS

#### Branch Circuit Breakers (CH)

See **Pages V1-T1-2–V1-T1-12.**

#### Renovation Loadcenter

Description	Catalog Number
Five-circuit terminal block kit	<b>RN5TB</b>
Ground bar kits (two maximum per panel)	(See <b>Page V1-T1-24</b> )

#### Notes

- ① 100 A main breaker is rated 10 kAIC.
  - ② Combination style covers may be used in surface or flush applications.
- All main circuit breaker loadcenters are listed for use as service entrance equipment. Loadcenters are factory-bonded for service entrance applications. Remove bonding strap for separate neutral and ground bars for sub-feed applications.

#### Type CH Retrofit Interior



Type CH Retrofit Adjustable Interior



Type CH Retrofit Interior Collar and Assembly with Trim

#### Contents

<b>Description</b>	<b>Page</b>
Overview . . . . .	V1-T1-2
CH Specialty Products	
Spa Panels . . . . .	V1-T1-13
Surge Panel . . . . .	V1-T1-14
Plug-On Neutral Loadcenter . . . . .	V1-T1-16
Type CH Renovation Loadcenter . . . . .	V1-T1-17
Type CH Retrofit Interior Kits	
CH Loadcenter Options and Accessories . . . . .	V1-T1-21
CH Circuit Breakers . . . . .	V1-T1-31

### Type CH Retrofit Interior Kits

#### Product Description

Eaton’s unique Retrofit Interior allows the customer to cost-effectively and safely upgrade an electrical service without removing the existing enclosure from the wall.

#### Application Description

The Retrofit Interior is designed and tested specifically for renovating an outdated electrical panel in an apartment, a condominium or a single family home. These outdated panels are being recognized by local inspectors and other authorities as a possible hazard.

#### Opportunities to Retrofit

- Single- or three-phase
- Main lug only or main breaker
- Up to 42 circuits
- Up to 225 A interiors, 400 A available upon request
- Available with CH breakers (3/4-inch) with copper bus or BR breakers (1-inch) with aluminum bus
- The minimum lifetime warranty for residential breakers shall be as follows:
  - Limited lifetime warranty on all CH branch breakers and loadcenters
  - Refer to Eaton for complete warranty details

#### Features and Benefits

##### Upgrading Existing Electrical Infrastructure Is Simple

- Replaces vintage brands that have hard to find, expensive replacement breakers
- Safely upgrade to arc fault and ground fault breakers to meet current electrical codes
- Maximizes number of circuits available with compact design
- Eco-friendly in asbestos-filled environments
- Exclusive design

##### Save Time and Money Throughout the Installation

- Uses existing panel box and wires
- Eliminates expensive and time-consuming drywall/ paint repair
- Saves 2–3 hours of installation time compared to a complete panel changeout
- Eliminates precise measurements with field-adjustable kit

#### Standards and Certifications

Meets 2017 NEC wire bending requirements.

### CH Specialty Product Selection

To select the retrofit kit:

1. From the existing box size determine which retrofit groups are suitable (may be more than one).
2. Use type of interior, number of phases, and type of main to find the selection chart.
3. Select part number from chart (if main breaker, replace XXX with specific amp rating).

#### How to Order:

1. Measure the existing panel enclosure to determine appropriate kits for your project.
2. Match the existing dimensions with the table below to obtain the correct catalog number.
3. Order your retrofit kit from a local Eaton authorized distributor.

Need assistance or can't find retrofit to fit existing enclosure?

Phone:  
800-330-6479

E-mail:  
FlexCenterLincoln@Eaton.com

Locate an Eaton Certified Contractor at  
EatonCertified.com

### Retrofit Interior Kit Specifications

Catalog Number ①	Cover ②	Existing Enclosure Parameters—Inches (mm)				Phase	Main	Bus	Amperes ③	Spaces / Circuits	UL 67 Listed
		Minimum Depth	Maximum Depth	Minimum Width	Minimum Height						
<b>CH Retrofit Interiors and Covers</b>											
RWCH6L125N	CRWCH6ML****	3.13 (79.5)	4.13 (104.9)	7.00 (177.8)	10.00 (254.0)	Single	MLO	CH	125	6	No
RSCH10B125N	CRWCH12ML****	3.50 (88.9)	4.50 (114.3)	8.50 (215.9)	16.50 (419.1)	Single	MCB	CH	125	10	No
RSCH12L125N	CRWCH12ML****	3.50 (88.9)	4.50 (114.3)	8.50 (215.9)	16.50 (419.1)	Single	MLO	CH	125	12	No
RACH22B125_	CRACH24ML****	3.75 (95.3)	4.25 (108.0)	13.00 (330.2)	21.00 (533.4)	Single	MCB	CH	125	22	No
RACH24L125_	CRACH24ML****	3.75 (95.3)	4.25 (108.0)	13.00 (330.2)	21.00 (533.4)	Single	MLO	CH	125	24	No
RBCH24B200_	CRBCH24CS****	3.75 (95.3)	6.00 (152.4)	13.00 (330.2)	29.00 (736.6)	Single	MCB	CH	200	24	No
RBCH32L200_	CRBCH32ML****	3.75 (95.3)	6.00 (152.4)	13.00 (330.2)	29.00 (736.6)	Single	MLO	CH	200	32	No
RCCH32B200_	CRBCH32CS****	3.75 (95.3)	6.00 (152.4)	13.00 (330.2)	34.00 (863.6)	Single	MCB	CH	200	32	No

### Complete Assembly

**Note:** For complete assembly, interior and cover need to be ordered separately.

#### Adjustable Interior

- Factory installed ground and neutral bars positioned to accept existing wires
- Field adjustable depth matches existing panel box
- Adjustable height enables optional placement of the interior
- Field bondable for service entrance options



Adjustable Interior

#### Standard Trim and Collar

- Standard trim matches new interior
- New circuit directory for updated labeling
- Oversized collar eliminates expensive wall/paint repair



Collar and Assembly with Trim

#### Notes

① Catalog numbers shown with “\_” at the end need one of the following suffixes to denote depth:  
J = 3.75–4.25  
K = 4.25–5.00  
L = 5.00–6.00  
Example: RBCH24B200J would signify an interior set with a depth range of 3.75 to 4.25 inches.

② \*\*\*\*Denotes characters in the catalog number that relate to overall cover size. Example: CRWCH6ML2620 would signify a cover 26.00 inches H x 20.00 inches W, or CRBCH24CS3324 would be 33.00 inches H x 24.00 inches W.

③ Amperes for MB panels is maximum; catalog number will reflect actual amperage of breaker included.

For UL applications, maximum cover sizes may apply.

# 1.1

## Loadcenters and Circuit Breakers

### Type CH Loadcenters and Circuit Breakers

#### 1

#### Non-Metallic Loadcenter

##### Single-Phase—Main Lug Loadcenters, Non-Metallic

2460SNM



##### Single-Phase Three-Wire—120/240 Vac—Insulated/Bondable Neutral

Main Ampere Rating	Maximum Number 1-Inch (25.4 mm)		Enclosure Type	Trim Type	Box Size	Wire Size Range Cu/Al 60 °C or 75 °C for Main Lugs	Loadcenter Catalog Number
	Spaces	Circuits					
40 ①	2	4	Indoor	Flush (no door)	2	②	TT120FLGNM ②③
	2	4	Indoor	Surface (no door)	2		TT120SLGNM ②③
60	2	4	Indoor	Flush (no door)	2	#14-2	2460FNM
	2	4	Indoor	Surface (no door)	2		2460SNM
	2	4	Indoor	Flush (no door)	2		2460FGNM ③
	2	4	Indoor	Surface (no door)	2		2460SGNM ③
	2	4	Indoor	Surface (no door)	2		2460SGNM ③
	2	4	Outdoor	—	—		2460RNM-A2

#### Notes

- ① Suitable for use as service equipment when not more than six main disconnecting means are provided and when not used as a lighting and appliance panelboard.
- ② This device has no main lugs. A Type BR or BD breaker is required to be backed to supply power to branch breakers. This device is single-phase 120 Vac only. With the use of three Type BR breakers, there are two branch circuits available. With the use of three Type BD breakers, there are five branch circuits available.
- ③ Includes GB4NM ground bar.

### Options and Accessories—Mechanical Interlocks



### Contents

Description	Page
Overview	V1-T1-2
CH Specialty Products	
Spa Panels	V1-T1-13
Surge Panel	V1-T1-14
Plug-On Neutral Loadcenter	V1-T1-16
Type CH Renovation Loadcenter	V1-T1-17
Type CH Retrofit Interior Kits	V1-T1-18
CH Loadcenter Options and Accessories	
Technical Data and Specifications	V1-T1-26
Dimensions	V1-T1-29
CH Circuit Breakers	V1-T1-31

## CH Loadcenter Options and Accessories

### Product Selection

#### CHSF2125



#### Field Installation and Parts

##### Description

- Sub-feed lug blocks—two-pole, 125 A, 3/4-inch (19.1 mm) spaces needed
- Sub-feed lug blocks—three-pole, 125 A, 3/4-inch (19.1 mm) spaces needed
- Neutral/ground lug—add-on neutral or ground lug

##### Ordering Quantity<sup>①</sup>

##### Catalog Number

- 1 CHSF2125
- 1 CHSF3125
- 1 NL20
- 1 NL30
- 1 NL300

#### CHSF3125



- Filler plates—3/4-inch (19.1 mm) space circuit breaker space
- CSR main circuit breaker filler plate (with hardware)
- Door lock—12–42 circuits, and 100–225 A
- Sandlewood spray paint
- ANSI-61 light gray touchup paint for outdoor loadcenters

- 25 CHFP
- 1 CSRFP
- 1 TDL
- 1 SPCSW
- 1 SPC61

#### CHFP



- Isolated neutral assembly (computer circuits)
- Circuit directory—adhesive backed
- Cover screws

- 1 BINA
- 10 TCD
- 25 LCCS

#### TDL



- Cover replacement latch 14-5/16 inch (363.55 mm) wide loadcenters only
- Circuit marking strip (next to breakers)
- Circuit identification label (preprinted breaker labels next to breakers)

- 1 CHRLS
- 10 CHMS
- 25 CHBL

#### BINA



- Series rated caution label
- Branch circuit numbering strip
- Bonding strap with screw
- CH plug-on neutral ground bonding strap

- 25 SRL
- 20 CHNS
- 1 BSSUSE
- 1 BSCHPON

#### Note

① Must be purchased in multiples of ordering quantities indicated.

# 1.1

## Loadcenters and Circuit Breakers

### Type CH Loadcenters and Circuit Breakers

1

#### Main Breaker Kits

Maximum Main Ampere Rating	Catalog Number	
	25 kAIC	35 kAIC
100	CSR2100N	CSH2100N
150	CSR2150N	CSH2150N
200	CSR2200N	CSH2200N
225	CSR2225N	CSH2225N

#### Main Lug Kits

Maximum Main Ampere Rating	Catalog Number
125	CHL125N
225	CHL225N



#### Main Breaker Kits

Breaker Ampere Rating	Lug Size	Catalog Number
100	#2–300 kcmil	CSR2100
150	#2–300 kcmil	CSR2150N
200	#2–300 kcmil	CSR2200N
225	#2–300 kcmil	CSR2225N

#### Mechanical Interlock Covers

Covers mechanically interlock two breakers. Type A covers interlock two CH breakers mounted across from one another. Type B covers interlock a main Type CSR breaker with a Type CH.

#### Mechanical Interlocks

	Type	Fits Loadcenter Catalog Numbers	Mechanical Interlock Trim/Deadfront Catalog Numbers	
			Flush	Surface
<b>CH8BRM Type A</b> 	A	CH12L125B	CH8BFM	CH8BSM
		CH16L125B		
		CH12L3125B		
		CH14B100B		
		CH20L125C	CH8CFM	CH8CSM
		CH24L125C		
		CH18L3125C		
		CH24L3125C		
		CH22B100C		
		CH22N100C		
		CH24L150D	CH8DFM	CH8DSM
		CH32L150D		
		CH24L3225D		
		CH30L3150D		
		CH42L225G	CH8GFM	CH8GSM
CH42L3225G				
Inner cover of Box B raintight	—	CH8BRM		
Inner cover of Box C raintight	—	CH8CRM		
<b>Indoor</b>				
<b>CH8EFM Type B</b> 	B	CH24B150E	CH8EFM	CH8ESM
		CH24B200E		
		CH24BPN200E		
		CH32B150J	CH8JFM	CH8JSM
		CH32B200J		
		CH3242B200J		
		CH32BPN200J		
		CH32N200J		
		CH32B225J		
		CH42B200K	CH8KFM	CH8KSM
		CH42N200K		
		CH42BPN200K		
		CH42B225K		
		CH60BPN200N	CH8NFM	—

### CH8EFM Type B



### Mechanical Interlocks, continued

Type	Fits Loadcenter Catalog Numbers	Mechanical Interlock Trim/Deadfront Catalog Numbers		
		Flush	Surface	
<b>Outdoor</b>				
B	CH8B150RF	CH3RDF7M	—	
	CH8B200RF			
	CH8N200RF			
	CH12B200RF			
	CH24B150R			
	CH24B200R			
	CH32B150R	CH3RDF9M	—	
	CH32B200R			
	CH32N200R			
	CH32B225R			
	CH42B200R	CH3RDF10M	—	
	CH42N200R			
	CH42B225R			
	<b>Next Generation Power Center</b>			
B	CHPC32B150L	CHPC8B32LFM	—	
	CHPC32B200L			
	CHPC32N200L			
	CHPC42B150L	CHPC8B42LFM	—	
	CHPC42B200L			
	CHPC42N200L			
	CHPC32B125TR	CH3RDF15M	—	
	CHPC32B150TR			
	CHPC32B200TR			
	CHPC32N200TR			
	CHPC42B150TR	CH3RDF16M	—	
	CHPC42B200TR			
	CHPC42N200TR			
	CHPC32B150TR	CH3RDF17M	—	
	CHPC32B200TR			
	CHPC42B200BR	CH3RDF18M	—	
	<b>Vintage <sup>①</sup></b>			
		CH20JJM200	CH7JFREPLM	—
	CH24JJM150			
	CH30JJM150			
	CH30JJM200			
	CH30JJM150H			
	CH3040JMM200			
	CH304JJM150			
	CH304JJM200			
	CH304JJM200H			
	CH30KKM225	CH7KKFREPLM	—	
	CH40KKM200H			
	CH40KKM225			
	CH40KKM200H			
	CH40KKM225H			
	CH304KKM200			
	CH304KKM200H			
	CH304LLM225	CH7LLFREPLM	—	
	CH424LLM225H			

**Note**

<sup>①</sup> If vintage part number does not match exactly, the cover may not fit. Simple variations such as an "N" at the end of the part number contain minor design variations that will prevent our cover from working with that particular loadcenter.



# 1.1

## Loadcenters and Circuit Breakers

### Type CH Loadcenters and Circuit Breakers

1

#### DS100H1



#### Field Installation Rainproof Conduit Hubs

Description	Conduit Size Inches (mm)	Ordering Quantity <sup>①</sup>	Catalog Number
Group 1—for use with 70, 100 and 125 A MLO and MCB loadcenters and circuit breaker enclosures	0.75 (19.1)	1	DS075H1
	1.00 (25.4)	1	DS100H1
	1.25 (31.8)	1	DS125H1
	1.50 (38.1)	1	DS150H1
	2.00 (50.8)	1	DS200H1
Group 2—for use with 150, 200 and 225 A MLO and MCB loadcenters and circuit breaker enclosures	2.00 (50.8)	1	DS200H2
	2.50 (63.5)	1	DS250H2
	3.00 (76.2)	1	DS300H2
Adapter kit—allows installing a Group 1 hub on devices arranged for Group 2 hubs	—	1	DS900AP
Group 1—small blank hub closure plate	—	1	DS900CP1
Group 2—large blank hub closure plate	—	1	DS900CP2

#### GBK14



#### Ground Bar Kits

Description (See Legend)	Length Inches (mm)	Ordering Quantity <sup>②</sup>	Catalog Number
●○○○○●	2.54 (64.5)	1	GBK5 <sup>②</sup>
●○○○○●■	3.59 (91.2)	1	GBK520 <sup>②</sup>
●○○○○●○○○○	4.29 (109.0)	1	GBK10 <sup>②</sup>
●○○○○●○○○○■	5.34 (135.6)	1	GBK1020 <sup>②</sup>
— — — — —	4.61 (117.1)	1	GBK13 <sup>②</sup>
●○○○○●○○○○○○○○	5.69 (144.5)	1	GBK14 <sup>②</sup>
●○○○○●○○○○○○○○■	6.74 (171.2)	1	GBK1420 <sup>②</sup>
●○○○○●○○○○○○○○○○○○	8.14 (206.8)	1	GBK21 <sup>②</sup>
●○○○○●○○○○○○○○○○○○■	9.19 (233.4)	1	GBK2120 <sup>②</sup>
○○○○○○●○○○○●○○○○○○	7.94 (201.7)	1	CH9GP21 <sup>③④</sup>

#### Ground Bar Legend

- = (3) #14–#10 Cu/Al or (1) #14–#4 Cu/Al
- = (1) #6–2/0 Cu/Al
- = (1) 1/0–14 or (3) #10–12 Cu/Al
- ⋈ = (1) #14–1/0 Cu/Al or (3) #14–#10 Cu/Al
- = Mounting hole

#### Grounded “B” Phase Adapters

Maximum Amperes	Three-Phase Loadcenter Types of Panels	Kit Catalog Number <sup>⑤</sup>
125	12–32 circuit main lug	CHGRD1
225	Main lug and CHH main breaker panels	CHGRD2
	CC main CB panels	CHGRD3

#### Neutral Bar Accessories

Description	Catalog Number <sup>⑤</sup>
Replacement neutral for all B and C type boxes	CHN125C
Replacement neutral for all D type boxes	CHN125D
Replacement neutral for all E, G, J, K and L type boxes	CHN225L
Isolated Neutral Assembly (computer circuits)	BINA

#### Notes

- ① Must be purchased in multiples of ordering quantities indicated.
- ② Distance between mounting holes is 1-3/4 inches (44.5 mm).
- ③ For single- and three-phase 400 A loadcenters.
- ④ Distance between mounting holes is 2-13/32 inches.
- ⑤ Cannot be used in Safety Breaker Panels. Classic Plus Panels only.

### Decorator Cover Accessory

- For easy use with CH loadcenters mounted in living space
- Easily wallpapered or painted to match any decor
- Loadcenter accessory—exclusively from Eaton



*Now you see it ...*

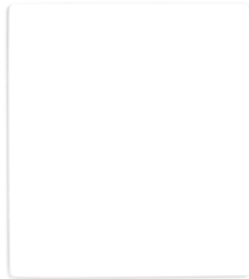

*... Now you don't.*

### Decorator Cover Accessory

Catalog Number	Existing CH Loadcenter Cover
CH8BF	CH8KDNB
CH8CF	CH8KDNC
CH8DF/EF	CH8KDND
CH8GF/JF	CH8KDNJ
CH8KF	CH8KDNK

### Loadcenter Goof Collars

Don't let an ugly drywall problem ruin a beautiful electrical installation.

Eaton's Goof Collar is designed to cover gaps between the finished drywall and loadcenter enclosure. This is often necessary when upgrading the electrical service and the drywall surrounding the panel is damaged. The collar allows 2 inches of overhang beyond the standard flush trim.



*Before*



*After*

### CH Goof Collars

Inches (mm)		Catalog Number	
Height	Width	Loadcenter Cover	Goof Collar
21.00 (533.4)	19.00 (482.6)	CH8BF	CH8BFC1921
26.00 (660.4)	19.00 (482.6)	CH8CF	CH8CFC1926
34.00 (863.6)	19.00 (482.6)	CH8DF	CH8DFC1934
		CH8EF	
		CHSUR8EF	
39.00 (990.6)	19.00 (482.6)	CH8GF	CH8JFC1939
		CH8JF	
42.00 (1066.8)	19.00 (482.6)	CH8KF	CH8KFC1942
		CHSUR8KF	
44.00 (1117.6)	19.00 (482.6)	CH8LF	CH8LFC1944
		CHSUR8LF	

**Technical Data and Specifications****General**

- A. The Contractor shall furnish and install loadcenters incorporating circuit breakers of the number, rating and type as specified herein and as shown on the contract drawings.
- B. The loadcenter and all components shall be designed, manufactured and tested in accordance with the latest applicable standards of UL and NEMA including:
  1. UL 67—standards for panelboards
  2. UL 50—standards for cabinets and boxes
  3. UL 489—standards for molded case circuit breakers
  4. Federal Spec Classification W-C 375
  5. UL 1699—all fault interrupting

**Qualifications**

- A. The manufacturer of the loadcenter shall be the manufacturer of the circuit breaker within the load center. All breakers shall be full size.
- B. For the equipment specified herein, the manufacturer shall be ISO® 9000 certified.
- C. The manufacturer of this equipment shall have produced similar electrical equipment for a minimum period of seven (7) years.

**Manufacturers**

- A. Eaton

**Ratings**

- A. Loadcenters shall be rated for 240 Vac and shall have short-circuit ratings as shown on the drawings or as herein scheduled, but not less than 10,000 amperes rms symmetrical.
- B. Breakers shall be full size and a minimum of 125 A frame. Breakers 10 –125 A trip size shall take up the same pole spacing.
- C. Loadcenters shall be labeled with a UL short-circuit rating. When series ratings are applied with integral or remote devices, a label shall be provided. Series ratings shall cover all trip ratings of installed frames. It shall state the conditions of the UL series ratings including:
  1. Size and type of upstream device.
  2. Branch devices that can be used.
  3. UL series short-circuit rating.

**Construction**

- A. All interiors, with the exception of the branch circuit breakers shall be completely factory assembled with main breakers, main lugs or no main device.
- B. Interiors shall be so designed that circuit breakers can be replaced without disturbing adjacent units and without removing the main bus connectors and shall be so designed that circuits may be changed without machining, drilling or tapping.
- C. Physical means must be provided to prevent the installation of more overcurrent devices than that number for which the enclosure was designed. Full size breakers are required.

**Bus**

- A. Busbars for the main and cross connectors shall be of silver flash plated copper construction in accordance with UL standards. Bussing shall be braced to 65 kAIC.
- B. Neutral bussing shall have a suitable lug for each outgoing feeder requiring a neutral connection of same ampacity as branch.

**Wiring/Termination**

- A. All wire connectors and terminals shall be of the anti-turn solderless type and suitable for copper or aluminum wire of the sizes indicated. All connectors shall meet the "Requirements for Wire Connectors and Soldering Lugs" UL 486B.
- B. All loadcenters where marked shall be suitable for use with 60/75 °C rated wire.

**Circuit Breakers**

- A. Circuit breakers shall be molded case type, 3/4-inch (19.1 mm) wide per pole. Multipole circuit breakers shall be of a stack pole design to provide electrical phase isolation and have an internal common trip.
- B. Each pole of the circuit breaker will have inverse time delay overload and instantaneous short-circuit protection by means of both thermal and magnetic sensors. Circuit breakers shall be quick-make/quick-break.
- C. The circuit breaker calibration shall not be affected by environmental changes in relative humidity. Breakers shall be calibrated after assembly.
- D. All circuit breakers shall be operated by a toggle-type handle and multipole circuit breakers shall have an internal common trip mechanism. The circuit breakers shall incorporate trip mechanisms that are mechanically trip-free from the handle. The handle position shall provide good visual trip indication.
- E. Contacts shall be of non-welding silver alloy.
- F. All branch breaker handles shall be of a different color than the case of the breaker.
- G. All terminals shall be listed for use with copper or aluminum conductors. Terminals shall be of the box lug design. The terminals shall meet UL 486B requirements and shall be suitable for use with either 60 °C or 75 °C wire.
- H. Breakers shall be SWD rated and/or HACR rated as required.
- I. Arc fault interrupting circuit breakers, (AFC), shall be provided on all 15 and 20 A single-phase 120/240 Vac circuits except those indicated as remote controlled breakers. AFI breakers shall be "Classified for mitigating the effects of arcing faults," or conforming to UL Standard 1699 and as defined by per Article 210.12 Section A of the NEC Code.

**Enclosures**

- A. Loadcenters shall have NEMA 1 general purpose or NEMA 3R rainproof enclosures as indicated on the drawings and shall be surface or flush mounted except where noted.
- B. For indoor applications, enclosures shall be rated NEMA 1. Enclosures shall be manufactured from cold-rolled code-gauge sheet steel having multiple knockouts and painted per paint specification. For outdoor applications, enclosures shall be rated NEMA 3R. Enclosures shall be manufactured from galvanized steel which shall be painted per the painted as specified. Enclosures shall be of sufficient size to meet or exceed NEC wire bending space.
- C. The cover shall have an easy adjustment feature for flush applications.
- D. Boxes shall be factory assembled into a single rigid structure.
- E. Provide circuit breaker marking labels and directories.

**Finish**

- A. Boxes and trims shall be finished with a high scratch-resistant aesthetically pleasing finish. The finish shall be polyurethane coating electrostatically applied to a thickness of 1.8 to 2 mils.

All loadcenters shall be provided with provisions for accepting a paintable or wall paperable decorator accessory cover. Where loadcenters are installed in living areas, provide manufacturer designed and tested decorator cover kits.

**CH Loadcenters****Description****Service**

Single-phase, three-wire, 120/240 Vac

Three-phase, four-wire, 208Y/120 Vac

Three-phase, three-wire, 240 V corner grounded delta

Three-phase, three-wire, 240 Vac delta

**Short-Circuit Current Rating**

10 kAIC: All single- and three-phase loadcenters 40–400 A, 2–42 circuits except when series ratings are applied

35 kAIC available on convertible units using CSH main breaker

25 kAIC: All factory-installed main breakers single-phase loadcenters rated 150–225 A using Type CSR main breakers

42 and 100 kAIC are available on some styles: single-phase and three-phase

**Main Breaker/Main Lug Loadcenters**

Single-phase

Three-phase

Main breaker: 100, 125, 150, 200, 225, 400 A

Main breaker: 150, 200, 225, 300, 400 A

Main lugs: 40, 70, 125, 150, 200, 225, 400 A

Main lugs: 125, 150, 200, 225, 400 A

**Convertible Loadcenters**

Main breaker or main lugs: single-phase up to 225 A

**Branch Breakers**

Type CH: 10–150 A. Single-, two- and three-pole. Selected amperages available in shunt trip, HACR and switching duty

Type CH-AFCI arc fault circuit interrupter

Ground fault circuit interrupters: 15–60 A

Type CHP: 10–125 A. Single-, two- and three-pole. three-position commercial trip

Type CH-HID: 15–30 A. Single-, two- and three-pole

Selected amperages available in HACR switching duty

CH-HM high magnetic

Type CHP-HID: 15–30 A. Single-, two- and three-pole

CH-M50 high ambient

Type CHP-GFCI: 15–30 A. Single-pole ground fault breakers

**Enclosures**

NEMA® Type 1 indoor

NEMA Type 3R outdoor

**Loadcenter and Breaker Accessories**

Branch circuit breaker:

Complete line of ground bar kits 5, 10, 14 and 21 circuits, some with additional #2/0 lugs

Auxiliary components

Each terminal will accommodate: (3) #14–#10 Cu/Al or (1) #14–#4 Cu/Al

Hold-down kits

Sub-feed lugs 125, 150 A—two- and three-pole

Handle ties

Shunt trips

Lockoffs

Universal rainproof conduit hubs Group One: 3/4, 1, 1-1/4, 1-1/2, 2 inches (19.1, 25.4, 31.8, 38.1, 50.8 mm)

Lockdogs

Group Two: 2, 2-1/2, 3 inches (50.8, 63.5, 76.2 mm)

Adapter plate

**Bussing**

Silver flash plated copper bus is a standard feature

### Dimensions

Approximate Dimensions in Inches (mm)

#### Residential/Commercial/Unit Enclosure—Box Sizes

**Note:** Box sizes do not include covers/fronts.

#### Residential Loadcenters

Box Size	Height	Width	Depth
<b>NEMA Type 1 Indoor</b>			
5	9.50 (241.3)	4.50 (114.3)	3.13 (79.4)
6	11.38 (288.9)	6.88 (174.6)	3.39 (86.1)
7	13.00 (330.2)	11.00 (279.4)	3.69 (93.7)
B	16.75 (425.5)	14.31 (363.5)	3.88 (98.4)
C	21.00 (533.4)	14.31 (363.5)	3.88 (98.4)
D	29.13 (739.8)	14.31 (363.5)	3.88 (98.4)
E	29.13 (739.8)	14.31 (363.5)	3.88 (98.4)
G	34.13 (866.8)	14.31 (363.5)	3.88 (98.4)
J	34.13 (866.8)	14.31 (363.5)	3.88 (98.4)
K	37.00 (939.8)	14.31 (363.5)	3.88 (98.4)
L	39.00 (990.6)	14.31 (363.5)	3.88 (98.4)
N	45.00 (1143.0)	14.31 (363.5)	3.88 (98.4)

#### NEMA Type 3R Outdoor

5R	9.50 (241.3)	4.50 (114.3)	3.13 (79.4)
6R	11.75 (298.5)	6.50 (165.1)	4.50 (114.3)
7R	13.00 (330.2)	11.00 (279.4)	3.69 (93.7)
B	16.75 (425.5)	14.31 (363.5)	5.19 (131.8)
C	21.00 (533.4)	14.31 (363.5)	5.19 (131.8)
D	29.13 (739.8)	14.31 (363.5)	5.19 (131.8)
E	29.13 (739.8)	14.31 (363.5)	5.19 (131.8)
G	34.13 (866.8)	14.31 (363.5)	5.19 (131.8)
J	34.13 (866.8)	14.31 (363.5)	5.19 (131.8)
K	37.00 (939.8)	14.31 (363.5)	5.19 (131.8)
L	39.00 (990.6)	14.31 (363.5)	5.19 (131.8)

#### Commercial Loadcenters

Box Size	Height	Width	Depth
<b>NEMA Type 1 Indoor</b>			
P	54.38 (1381.1)	21.00 (533.4)	6.00 (152.4)
PM	62.63 (1590.7)	21.00 (533.4)	6.00 (152.4)

#### Types ECB and ECC Unit Enclosures

Height	Width	Depth
<b>NEMA Type 1 Indoor</b>		
23.25 (590.6)	8.88 (225.4)	4.50 (114.3)
<b>NEMA Type 3R Outdoor</b>		
23.69 (601.7)	9.31 (236.5)	5.44 (138.1)

#### Residential Loadcenter Knockout

Residential NEMA Type 1 Indoor and NEMA Type 3R Outdoor Enclosures.

#### Knockouts for Box Sizes 5, 6, 7, 5R, 6R, 7R

Code	Diameter			
A	0.50 (12.7)	—	—	—
B	0.50 (12.7)	0.75 (19.1)	—	—
C	0.50 (12.7)	0.75 (19.1)	1.00 (25.4)	—
D	0.50 (12.7)	0.75 (19.1)	1.00 (25.4)	1.25 (31.8)
E	0.75 (19.1)	1.00 (25.4)	1.25 (31.8)	—
F	0.75 (19.1)	1.00 (25.4)	1.25 (31.8)	1.50 (38.1)
G	1.00 (25.4)	1.25 (31.8)	1.50 (38.1)	—
H	1.00 (25.4)	1.25 (31.8)	1.50 (38.1)	2.00 (50.8)
I	1.25 (31.8)	1.50 (38.1)	2.00 (50.8)	—

#### Knockout Positions

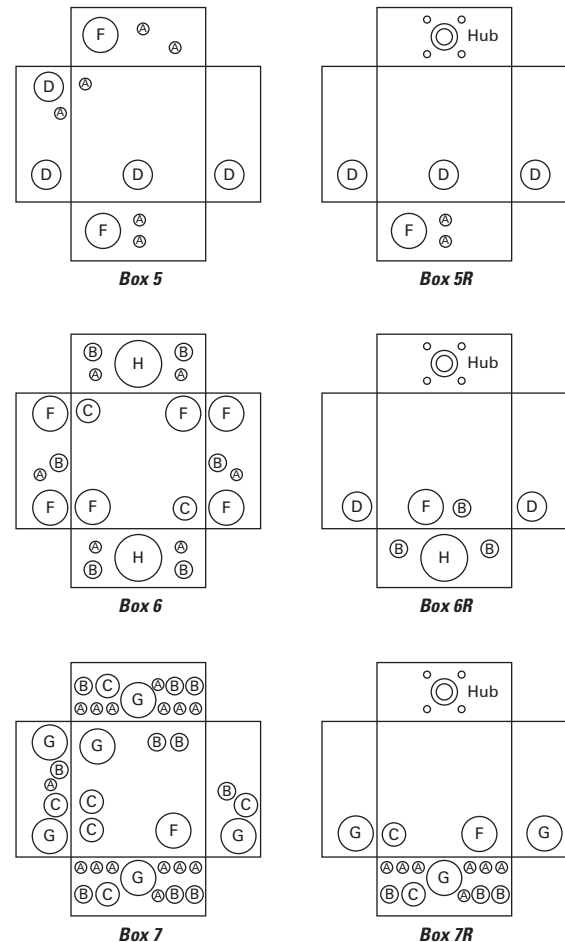

# 1.1

## Loadcenters and Circuit Breakers

### Type CH Loadcenters and Circuit Breakers

1

Approximate Dimensions in Inches (mm)

#### Residential and Commercial Loadcenter Knockout

Residential NEMA Type 1 indoor and NEMA Type 3R outdoor enclosures.

#### Knockouts for Box Sizes 8, 8R, P, PM, B, C, D, E, G, J, K, L, N and Outdoor Boxes 12–60 Circuits

Code	Diameter				
a	0.75 (19.1)	—	—	—	—
b	0.50 (12.7)	0.75 (19.1)	—	—	—
c	0.50 (12.7)	—	—	—	—
d	1.00 (25.4)	1.25 (31.8)	1.50 (38.1)	2.00 (50.8)	2.50 (63.5)
e	1.25 (31.8)	1.50 (38.1)	2.00 (50.8)	2.50 (63.5)	—
f	0.75 (19.1)	1.25 (31.8)	1.50 (38.1)	2.00 (50.8)	—
g	0.50 (12.7)	0.75 (19.1)	1.00 (25.4)	—	—
h	1.50 (38.1)	2.00 (50.8)	2.50 (63.5)	—	—
i	0.50 (12.7)	0.75 (19.1)	1.00 (25.4)	1.25 (31.8)	1.50 (38.1)
j	1.00 (25.4)	1.25 (31.8)	1.50 (38.1)	—	—
k	1.25 (31.8)	1.50 (38.1)	2.00 (50.8)	—	—
m	0.75 (19.1)	1.00 (25.4)	1.25 (31.8)	1.50 (38.1)	2.00 (50.8)
n	0.75 (19.1)	1.00 (25.4)	1.25 (31.8)	1.50 (38.1)	—
p	2.00 (50.8)	2.50 (63.5)	—	—	—

#### Knockout Diagram

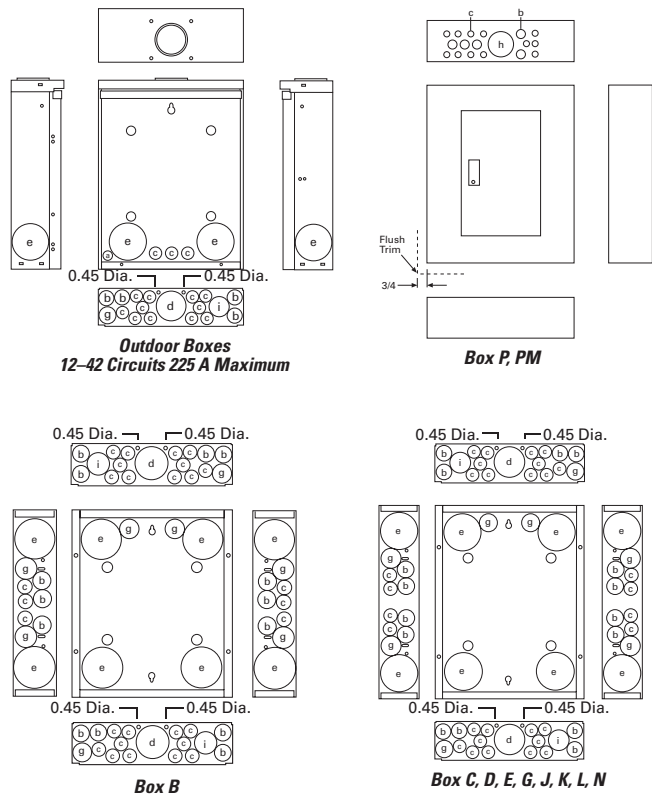

#### Type ECB and ECC Unit Enclosure Knockout

Code	Diameter				
<b>NEMA Type 1 Indoor (Flush and Surface Trims)</b>					
A	0.50 (12.7)	—	—	—	—
B	1.25 (31.8)	1.50 (38.1)	1.75 (44.5)	2.00 (50.8)	2.50 (63.5)
<b>NEMA Type 3R Outdoor</b>					
A	0.50 (12.7)	—	—	—	—
B	1.25 (31.8)	1.50 (38.1)	1.75 (44.5)	2.00 (50.8)	2.50 (63.5)

#### NEMA Type 1—Indoor

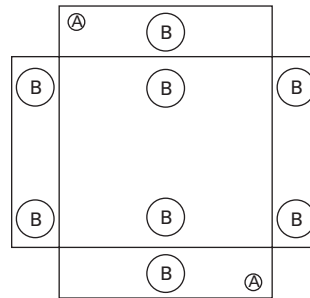

#### NEMA Type 3R—Outdoor

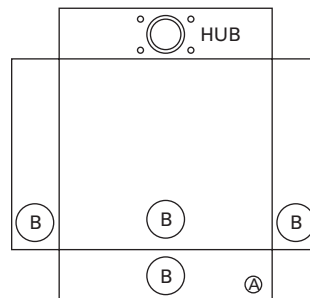

### Plug-On Circuit Breakers



## CH Circuit Breakers

### Product Description

Quick-make, quick-break switch mechanism combined with inverse time element tripping operation and trip-free handle design. Type CH circuit breakers trip to the OFF position, eliminating nuisance callbacks. The CHF family also includes a trip flag to differentiate between a trip and the breaker being turned off. The thermal-magnetic trip curve avoids nuisance tripping on mild overloads while reacting almost instantaneously to severe short-circuit conditions. Multipole breakers have internal common trip connection to operate all poles simultaneously. Handles are marked with ON-OFF indication and ampere rating of the breaker.

### Special Application Plug-On Circuit Breakers—Type CH 10 kAIC 120 Vac and 120/240 Vac

#### Branch Feeder Type Arc Fault Circuit Breakers

A branch feeder type arc fault circuit interrupter is a device intended to mitigate high current arcing faults in the complete circuit, including connected cords. High current arcing faults can occur from line to neutral or line to ground. These arcing faults are in parallel with the load and produce the most energy of all arcing faults.

The branch feeder type AFCI is required in the 1999 and 2002 National Electrical Code.

The Combination Type AFCI is required in all subsequent editions of the National Electrical Code.

#### Combination Type Arc Fault Circuit Breakers

A combination type arc fault circuit interrupter is a device that offers mitigation of high current arcing faults in the complete circuit, including connected cords. In addition it provides direct detection of persistent low current arcing faults down to 5 amps with associated mitigation of fire hazards in the cords connected to the outlets. High current arcing faults can occur from line to neutral or line to ground. These arcing faults are in parallel with the load and produce the most energy of all arcing faults. The current level of low current arcing faults is limited by the load.

#### Ground Fault Circuit Breakers—Ground Fault Application Notes

Single-pole Type CHGFI are designed for use in two-wire, 120 Vac circuits. The diagram on [Page V1-T1-40](#) shows a typical wiring configuration.

## Contents

### Description

	<i>Page</i>
Overview .....	<b>V1-T1-2</b>
CH Specialty Products .....	<b>V1-T1-13</b>
CH Loadcenter Options and Accessories .....	<b>V1-T1-21</b>
CH Circuit Breakers	
Product Selection .....	<b>V1-T1-32</b>
Options and Accessories .....	<b>V1-T1-38</b>
Technical Data and Specifications .....	<b>V1-T1-40</b>
Wiring Diagrams .....	<b>V1-T1-40</b>

Two-pole Type CHGFIs are designed for use in three-wire, 120/240 Vac circuits, 120 Vac multiwire circuits employing common, neutral and two-wire, 240 Vac circuits obtained from a 120/240 Vac source.

Diagrams on [Page V1-T1-40](#) illustrate typical wiring configurations for 120/240 Vac multiwire circuits.

The diagram on [Page V1-T1-40](#) depicts a 240 Vac, two-wire circuit. Note the “panel neutral” conductor connects to the neutral bar,

even though the neutral is not included in the load circuit. This connection is necessary to supply a 120 Vac power source to the ground fault sensing circuit.

The figures are shown with a 120/240 Vac, single-phase, three-wire power source, but are also applicable to a 120/208 Vac, three-phase, four-wire power supply. For all figures, the electrical operation of the Type CHGFI is not affected by the equipment ground.

### Features

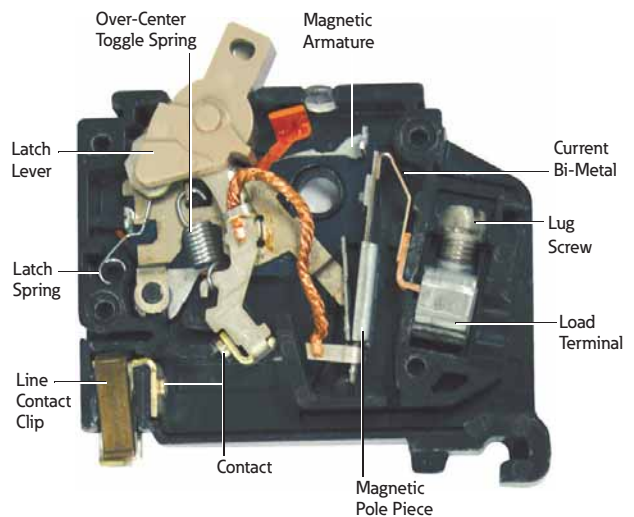



# 1.1

## Loadcenters and Circuit Breakers

### Type CH Loadcenters and Circuit Breakers

1



#### Product Selection

10 kAIC, 120 Vac, 120/240 Vac and 240 Vac

##### Type CH Plug-On Circuit Breakers





#### Type CH Breakers, 3/4-Inch (19.1 mm) per Pole 120, 120/240 or 240 Vac, 10 kAIC

Ampere Rating	Wire Size Range Cu/Al 60 °C or 75 °C	Catalog Number		
		Single-Pole 120/240 Vac Requires One 3/4-Inch (19.1 mm) Space 10 per Shelf Carton	Two-Pole 120/240 Vac Common Trip Requires Two 3/4-Inch (19.1 mm) Spaces 5 per Shelf Carton	Three-Pole 240 Vac Common Trip Requires Three 3/4-Inch (19.1 mm) Spaces 5 per Shelf Carton
10	(1) #14–8 ①	 <b>CH110</b>	 <b>CH210</b>	 <b>CH310</b>
15	(2) #14–10 ①② (1) #14–6 ③	<b>CH115</b> ⑥⑦	<b>CH215</b> ⑦	<b>CH315</b> ⑦
20		<b>CH120</b> ⑥⑦	<b>CH220</b> ⑦	<b>CH320</b> ⑦
25		<b>CH125</b> ⑦	<b>CH225</b> ⑦	<b>CH325</b> ⑦
30		<b>CH130</b> ⑦	<b>CH230</b> ⑦	<b>CH330</b> ⑦
35	#14–2 ① #14–6 ③	<b>CH135</b> ⑦	<b>CH235</b> ⑦	<b>CH335</b> ⑦
40	#10–1/0 ④	<b>CH140</b> ⑦	<b>CH240</b> ⑦	<b>CH340</b> ⑦
45	#14–2 #3/0	<b>CH145</b> ⑦	<b>CH245</b> ⑦	<b>CH345</b> ⑦
50		<b>CH150</b> ⑦	<b>CH250</b> ⑦	<b>CH350</b> ⑦
60		<b>CH160</b>	<b>CH260</b>	<b>CH360</b>
70		<b>CH170</b>	<b>CH270</b>	<b>CH370</b>
80		—	<b>CH280</b>	<b>CH3080</b>
90		—	<b>CH290</b>	<b>CH3090</b>
100		—	<b>CH2100</b>	<b>CH3100</b>
110		—	<b>CH2110</b>	—
125		—	<b>CH2125</b>	—

##### Type CH Plug-On Circuit Breakers



#### CHF Breakers with Mechanical Trip Flag

Ampere Rating	Wire Size Range Cu/Al 60 °C or 75 °C	Catalog Number	
		Single-Pole 120/240 Vac Requires One 3/4-Inch (19.1 mm) Space 10 per Shelf Carton	Two-Pole 120/240 Vac Common Trip Requires Two 3/4-Inch (19.1 mm) Spaces 5 per Shelf Carton
10	(1) #14–8 ①	 <b>CHF110</b>	 <b>CHF210</b>
15	(2) #14–10 ①②	<b>CHF115</b> ⑥⑦	<b>CHF215</b> ⑦
20		<b>CHF120</b> ⑥⑦	<b>CHF220</b> ⑦
25		<b>CHF125</b> ⑦	<b>CHF225</b> ⑦
30		<b>CHF130</b> ⑦	<b>CHF230</b> ⑦
35	#14–2 ①	<b>CHF135</b> ⑦	<b>CHF235</b> ⑦
40	#14–4 ④	<b>CHF140</b> ⑦	<b>CHF240</b> ⑦
45		<b>CHF145</b> ⑦	<b>CHF245</b> ⑦
50		<b>CHF150</b> ⑦	<b>CHF250</b> ⑦

##### Notes

- ① For single- and two-pole breakers.
- ② Solid and stranded wire can be used together.
- ③ For three-pole breakers.
- ④ Single-pole and two-pole 40–50 A.
- ⑥ Two-pole 150 A.
- ⑦ Switching duty rated.
- ⑦ HACR rated.

For factory-installed options, refer to **Page V1-T1-39**.

### Type CH AF/GF Single-Pole Circuit Breaker

Type CH AFCI Single-Pole Circuit Breaker



### Dual Purpose Arc Fault/Ground Fault 3/4-Inch (19.1 mm) Wide Circuit Breakers, Type CH, 120 Vac— 10 kAIC <sup>①②</sup>

Poles	Ampere Rating	Configuration	Catalog Number
Single-pole 10 kAIC	15	Combination AFCI GFCI	CHFAFGF115 <sup>③</sup>
	20	Combination AFCI GFCI	CHFAFGF120 <sup>③</sup>
Single-pole, plug-on neutral 10 kAIC	15	Combination AFCI GFCI	CHFAFGF115PN
	20	Combination AFCI GFCI	CHFAFGF120PN

### Plug-On Branch Feeder Type Arc Fault Circuit Breakers, Type CH 10 kAIC, 120 Vac and 120/240 Vac

Type CH AFCI Single-Pole Circuit Breaker



### Combination Type CH AFCI 3/4-Inch (19.1 mm) Wide Circuit Breakers

Poles	Ampere Rating	Catalog Number
<b>Standard Pigtail</b>		
Single-pole 10 kAIC	15	CHFCAF115
	20	CHFCAF120
Two-pole 10 kAIC	15	CH215CAF
	20	CH220CAF

Type CH AFCI Single-Pole Circuit Breaker



### Branch Type CH AFCI 3/4-Inch (19.1 mm) Wide FIRE-GUARD<sup>®</sup> Circuit Breakers

Poles	Ampere Rating	Configuration	Catalog Number
Single-pole 10 kAIC	15	AFCI	CH115AF <sup>③</sup>
	20	AFCI	CH120AF <sup>③</sup>
Two-pole 10 kAIC <sup>④⑤</sup>	15	AFCI common trip	CH215AF
	20	AFCI common trip	CH220AF

### Plug-On Combination Type Arc Fault Circuit Breakers and Ground Fault, Type CH 10 kAIC, 120 Vac and 120/240 Vac <sup>⑥</sup>

Type CH AFCI Single-Pole PON Combo Circuit Breaker



### Combination Type CH AFCI 3/4-Inch (19.1 mm) and CHGFCI Circuit Breakers

Poles	Ampere Rating	Configuration	Catalog Number
Single-pole 10 kAIC	15	AFCI plug-on neutral	CHFCAF115PN
	20	AFCI plug-on neutral	CHFCAF120PN
	15	GFCI plug-on neutral	CHFGFT115PN
	20		CHFGFT120PN
	25		CHFGFT125PN
	30		CHFGFT130PN

**Notes**

- ① Breaker qualifies as combination arc fault, per UL 1699.
- ② Breaker qualifies as personnel protection ground fault, (5 mA) per UL 943.
- ③ Clamshell packaging available with CS modification code on the end of catalog number.
- ④ Common trip refers to two-pole 240 V load application sourced by 120/240 Vac (see diagram on **Page V1-T1-40**).
- ⑤ Independent trip refers to two-pole multi-wire, home run or shared neutral circuits (see diagrams on **Page V1-T1-40**).
- ⑥ Requires plug-on neutral loadcenter.

# 1.1

## Loadcenters and Circuit Breakers

### Type CH Loadcenters and Circuit Breakers

1

#### Plug-On Ground Fault Circuit Breakers, Type CH 10 kAIC, 120 Vac and 120/240 Vac

##### Type CH Single-Pole



#### Type CH Ground Fault Circuit Breakers (5 Milliampere) 3/4-Inch (19.1 mm) per Pole 120 Vac or 120/240 Vac, 10 kAIC

Ampere Rating	Wire Size Range Cu/Al 60 °C or 75 °C ①	Catalog Number—1 per Shelf Carton	
		Single-Pole 120 Vac Requires One 3/4-Inch (19.1 mm) Space	Two-Pole 120/240 Vac Common Trip Requires Two 3/4-Inch (19.1 mm) Spaces
15	#14–6	CHFGFT115	CH215GFT
20	#14–6	CHFGFT120	CH220GFT
25	#14–6	CHFGFT125	CH225GFT
30	#14–6	CHFGFT130	CH230GFT
35	#14–6	—	CH235GFT
40	#14–6	—	CH240GFT
45	#14–6	—	CH245GFT
50	#14–6	—	CH250GFT
60	#14–6 ①	—	CH260GFT

##### Type CH Two-Pole



#### Type CH Ground Fault Equipment Protectors (30 Milliampere) 3/4-Inch (19.1 mm) per Pole 120 Vac or 120/240 Vac, 10 kAIC

Ampere Rating	Wire Size Range Cu/Al 60 °C or 75 °C ①	Catalog Number—1 per Shelf Carton	
		Single-Pole 120 Vac Requires One 3/4-Inch (19.1 mm) Space	Two-Pole 120/240 Vac Common Trip Requires Two 3/4-Inch (19.1 mm) Spaces
15	#14–6	CHFEP115	CH215EPD
20	#14–6	CHFEP120	CH220EPD
25	#14–6	CHFEP125	—
30	#14–6	CHFEP130	CH230EPD
40	#14–6	—	CH240EPD
50	#14–6	—	CH250EPD
60	#14–6 ①	—	CH260EPD

#### Type CH Switching Neutral Breakers—10 kAIC, 120 Vac and 120/240 Vac

Used to open the neutral along power line(s) for applications of gas pumps.

##### CH220SW



#### 3/4-Inch (19.1 mm) per Pole 120/240 or 240 Vac, 10 kAIC

Ampere Rating	Wire Size Range Cu/Al 60 °C or 75 °C	Catalog Number—1 per Shelf Carton	
		Two-Pole 120 Vac Common Trip Requires Two 3/4-Inch (19.1 mm) Spaces	Three-Pole 120/240 Vac Common Trip Requires Three 3/4-Inch (19.1 mm) Spaces
15	#14–8	CH215SW ②	CH315SW ③
20	#14–8	CH220SW ②	CH320SW ③
30	#14–8	CH230SW ②	CH330SW ③
40	#14–8	CH240SW ②	CH340SW ③
50	#14–8	CH250SW ②	CH350SW ③



#### Notes

- ① 60 A breaker listed for 75 °C Cu wire only.
- ② For circuit breakers with shunt trip, add ST suffix. Shunt trip requires one additional pole space.
- ③ Switching duty rated.

### Type CH-HID Circuit Breakers—10 kAIC, 120 Vac, 120/240 and 240 Vac

Suitable for use in circuits for fluorescent and high intensity discharge lighting. Also suitable for HACR applications.

#### 3/4-Inch (19.1 mm) per Pole 120 Vac, 120/240 and 240 Vac, 10 kAIC

Ampere Rating	Wire Size Range Cu/Al 60 °C or 75 °C	Single-Pole 120/240 Vac Requires One 3/4-Inch (19.1 mm) Space 10 per Shelf Carton Catalog Number	Two-Pole 240 Vac Common Trip Requires Two 3/4-Inch (19.1 mm) Spaces 5 per Shelf Carton Catalog Number	Three-Pole 240 Vac Common Trip Requires Three 3/4-Inch (19.1 mm) Spaces 5 per Shelf Carton Catalog Number
				
15	#14–8	CH115HID	CH215HID ①	CH315HID
20	#14–8	CH120HID	CH220HID	CH320HID
30	#14–8	CH130HID	CH230HID	CH330HID

### Type CHT Twin 10 kAIC, 120/240 Vac, Universal CTL and Non-CTL Plug-On Circuit Breakers

Suitable for CTL and Non-CTL loadcenters.

Type CH and CHT  
Circuit Breakers  
Mounted in Twin  
Breaker Panel

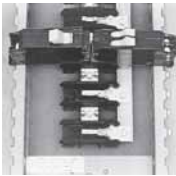

#### Twin (CTL) 3/4-Inch (19.1 mm) per Pole 120 Vac Class CTL 10 kAIC

Ampere Rating	Wire Size Range Cu/Al 60 °C or 75 °C	Single-Pole Requires One 3/4-Inch (19.1 mm) Space 10 per Shelf Carton Catalog Number
		 120/240 Vac 120/240 Vac
15–15	#14–8	CHT1515 ②③
15–20	#14–8	CHT1520 ②③
20–20	#14–8	CHT2020 ②③

#### Notes

- ① CH215HID is rated for 120/240 V.
- ② Switching duty rated.
- ③ HACR rated.

# 1.1

## Loadcenters and Circuit Breakers



### Type CH Loadcenters and Circuit Breakers

1

#### Type CHP Commercial Breakers—10 kAIC, 120 Vac, 120/240 Vac and 240 Vac

Note: CHP breakers feature on-off and trip positions for commercial applications.

#### 3/4-Inch (19.1 mm) per Pole 120, 120/240 or 240 Vac, 10 kAIC

Ampere Rating	Wire Size Range Cu/Al 60 °C or 75 °C	Single-Pole 120/240 Vac Requires One 3/4-Inch (19.1 mm) Space 10 per Shelf Carton Catalog Number	Two-Pole 120/240 Vac Common Trip Requires Two 3/4-Inch (19.1 mm) Spaces 5 per Shelf Carton Catalog Number	Three-Pole 240 Vac Common Trip Requires Three 3/4-Inch (19.1 mm) Spaces 5 per Shelf Carton Catalog Number
				
10	(1) #14–8 ①	CHP110	CHP210	CHP310
15	(2) #14–10 ①② (1) #14–6 ③	CHP115 ⑥⑦	CHP215 ⑦	CHP315 ⑦
20		CHP120 ⑥⑦	CHP220 ⑦	CHP320 ⑦
25		CHP125 ⑦	CHP225 ⑦	CHP325 ⑦
30		CHP130 ⑦	CHP230 ⑦	CHP330 ⑦
35	#14–2 ① #14–6 ③	CHP135 ⑦	CHP235 ⑦	CHP335 ⑦
40	#10–1/0 ④	CHP140 ⑦	CHP240 ⑦	CHP340 ⑦
45	#14–2 ⑤	CHP145 ⑦	CHP245 ⑦	CHP345 ⑦
50		CHP150 ⑦	CHP250 ⑦	CHP350 ⑦
60		CHP160 ⑦	CHP260 ⑦	CHP360 ⑦
70		CHP170	CHP270	CHP370
80		—	CHP280	—
90		—	CHP290	—
100		—	CHP2100	CHP3100
110		—	CHP2110	—
125		—	CHP2125	—

#### Notes

- ① For single- and two-pole breakers.
- ② Solid and stranded wire can be used together.
- ③ For three-pole breakers.
- ④ Single-pole 60–70 A, two-pole 80–125 A, three-pole 40–100 A.
- ⑤ Single-pole 40–50 A, two-pole 40–70 A.
- ⑥ Switching duty rated.
- ⑦ HACR rated.

CHP breakers offer on-off and trip positions for commercial applications.

### Type CHP Neutral Switching Breakers—10 kAIC, 120 Vac and 120/240 Vac

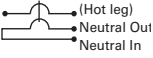
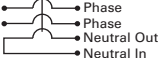

Used to open the neutral along power line(s) for applications of gas pumps.

#### 3/4-Inch (19.1 mm) per Pole 120 or 120/240 Vac, 10 kAIC

Ampere Rating	Wire Size Range Cu/Al 60 °C or 75 °C	Two-Pole 120 Vac Common Trip Requires Two 3/4-Inch (19.1 mm) Spaces 1 per Shelf Carton Catalog Number	Three-Pole 120/240 Vac Common Trip Requires Three 3/4-Inch (19.1 mm) Spaces 1 per Shelf Carton Catalog Number
			
15	#14–8	CHP215SW <sup>①</sup>	CHP315SW <sup>①</sup>
20	#14–8	CHP220SW <sup>①</sup>	CHP320SW <sup>①</sup>



### Type CH-M50 High Ambient Breaker

#### 3/4-Inch (19.1 mm) per Pole 120 or 120/240 Vac, 10 kAIC

Ampere Rating	Wire Size Range Cu/Al 60 °C or 75 °C	Single-Pole 120/240 Vac Requires One 3/4-Inch (19.1 mm) Space 10 per Shelf Carton Catalog Number	Two-Pole 120/240 Vac Common Trip Requires Two 3/4-Inch (19.1 mm) Spaces 5 per Shelf Carton Catalog Number
			
15	(1) #14–8	CH115M50	CH215M50
20	(2) #14–10	CH120M50	CH220M50
25		CH125M50	CH225M50
30		CH130M50	CH230M50
35		CH135M50	CH235M50
40		CH140M50	CH240M50
45		CH145M50	CH245M50
50		CH150M50	CH250M50
60		—	CH260M50
70		—	CH270M50

### Type CH-HM and CHP-HM High Magnetic Breakers

#### 3/4-Inch (19.1 mm) per Pole 120 or 120/240 Vac, 10 kAIC

Ampere Rating	Wire Size Range Cu/Al 60 °C or 75 °C	Single-Pole 120/240 Vac Requires One 3/4-Inch (19.1 mm) Space 10 per Shelf Carton Catalog Number	Two-Pole 120/240 Vac Common Trip Requires Two 3/4-Inch (19.1 mm) Spaces 5 per Shelf Carton Catalog Number
			
15	(1) #14–8	CH115HM	CH215HM
20	(2) #14–10	CH120HM	CH220HM
15	(1) #14–8	CHP115HM	CHP215HM
20	(2) #14–10	CHP120HM	CHP220HM

#### Note

<sup>①</sup> For circuit breakers with shunt trip, add ST suffix. Shunt trip requires one additional pole space, obtain pricing from [Page V1-T1-39](#).

# 1.1

## Loadcenters and Circuit Breakers

### Type CH Loadcenters and Circuit Breakers

1

#### Options and Accessories

CHHT



CHPL



CHPLGF



MCBPL



CHLO



CH125RB



CH9MB270



CHML



#### Field Installation Kits and Parts

Description	Ordering Quantity <sup>①</sup>	Catalog Number
<b>Handle Ties <sup>②</sup></b>		
Handle tie bar for physically joining the handles of two adjacent single-pole Type CH circuit breakers (molded plastic handle cover)	25	<b>CHHT</b>
<b>Handle Lockoffs <sup>③④</sup></b>		
Padlockable device for locking the handle of CH AFGF, CAF and GFT breakers into the ON or OFF position.		<b>CHFAFGFLOFF</b>
Padlockable device for locking the handle of single-, two- or three-pole Type CH circuit breakers (escutcheon mounted) <sup>⑤</sup>	1	<b>CHPL</b>
Padlockable device for locking the handle of a single-pole Type CHGFI circuit breaker (escutcheon mounted) <sup>⑤</sup>	1	<b>CHPLGF</b>
Padlockable bracket for locking the handle of two-, three- and four-pole Type CH circuit breakers	10	<b>CHPLOFF</b>
Padlockable device for locking the handle of main circuit breaker Types CC and CCH into the ON or OFF position.(screw mounted) <sup>⑥</sup>	1	<b>CCPL</b>
Padlockable device for locking the handle of main breaker Types BW and CSR into the ON or OFF position (escutcheon mounted) <sup>⑤</sup>	1	<b>MCBPL</b>
<b>Handle Lockdogs <sup>④⑦</sup></b>		
Device used to secure handle in ON or OFF position for single-pole Type CH circuit breakers (handle mounted) <sup>⑧</sup>	10	<b>CHLO</b>
<b>Hold-Down Kits <sup>⑨</sup></b>		
Hold-down retainer kit for single-, two-, three-pole Type CH circuit breakers. For 6–24 circuit 125 A single- and three-phase, 12–42 circuit single-phase 225 A and 24–42 circuit three-phase 225 A MLO Type CH loadcenters	1	<b>CH125RB</b>
Hold-down retainer kit for single-, two-, three-pole Type CH circuit breakers for 2–4 circuit MLO CH loadcenters.	1	<b>CH125RB24</b>
<b>Mounting Bases</b>		
Mounting base for two-pole Type CH circuit breaker—70 A maximum	1	<b>CH9MB270</b>
<b>Main Breaker Lug Kits</b>		
Types CC and CCH main breaker lug kit (2) 300 kcmil	1	<b>CCL300</b>
Type CSR main breaker lug kit (2) 300 kcmil	1	<b>MCBL300</b>
<b>Mechanical Interlock</b>		
Type CH for two-, three- and four-pole breakers	10	<b>CHML <sup>Ⓣ</sup></b>

#### Notes

- ① Must be purchased in multiples of ordering quantities indicated.
- ② Handle ties: typically used to join two similar independent single-pole breakers to form a two-pole noncommon trip breaker.
- ③ Handle lockoffs: devices that use a padlock to lock the circuit breaker's handle in the ON or OFF position.
- ④ Requires one additional pole space.
- ⑤ Escutcheon mounted: device mounted semipermanently to the face of the circuit breaker and secured by the loadcenter deadfront.
- ⑥ Screw mounted: device permanently mounted to the face of the circuit breaker by the use of a non-removable screw.
- ⑦ Handle lockdogs: devices that are used to secure a circuit breaker's handle in the ON or OFF position. Handle lockdogs are not padlockable devices.
- ⑧ Handle mounted: device mounted above or below handle using spring pressure.
- ⑨ Hold-down kits: devices used to secure the circuit breaker to the loadcenter for back-feed main application. See NEC Article 408.36(D).
- Ⓣ CHML not suitable to transfer emergency power.

### Shunt Trip Options

Description Type	Volts	Catalog Number Suffix Adder <sup>①</sup>
CSR	12 DC	<b>SR12</b>
CSR	24 DC	<b>SR24</b>
CSR	120 AC	<b>SR01</b>
CH	120 AC	<b>ST</b> <sup>②</sup>
CC	12 DC	<b>SR12</b>
CC	24 DC	<b>SR24</b>
CC	120 AC	<b>SR01</b>
CC	208 AC	<b>SR08</b>
CC	240 AC	<b>SR02</b>

### Handle Position Changeability Chart

Handle Lockoff and Lockdog Types	To Change Handle Position from ON to OFF or OFF to ON You Must...		
	Remove Padlock	Remove Device	Remove Loadcenter Deadfront
Lockoff escutcheon mounted	Remove	—	—
Lockoff screw mounted	Remove	—	—
Lockdog handle mounted	N/A	Remove	—

#### Notes

- ① Add suffix indicated to end of breaker catalog number.
- ② Requires one additional pole space.



# 1.1

## Loadcenters and Circuit Breakers

### Type CH Loadcenters and Circuit Breakers

1

#### Technical Data and Specifications

##### Ratings

Single- and two-pole CH breakers rated 15 and 20 A have low instantaneous magnetic trip levels. The 15 and 20 A breakers with “HM” suffix have high magnetic trip settings recommended for circuits with inherently high inrush currents. All Type CH breakers are marked for heating, air conditioning and refrigeration (HACR) equipment application. Single-pole 15–20 A breakers are also suitable for switching duty (SWD). Shunt trip coils operate on 120 Vac and require one additional pole space per breaker.

##### Wiring Diagrams

###### Typical Single-Pole

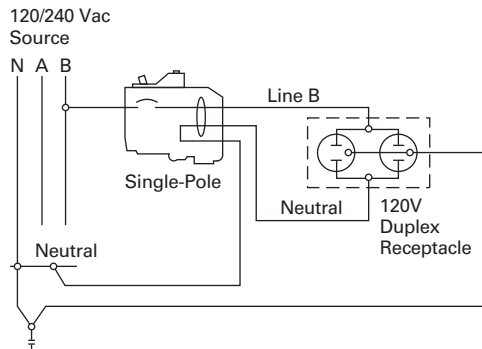

###### Two-Pole 240 V Load Application Sourced by 120/240 Vac

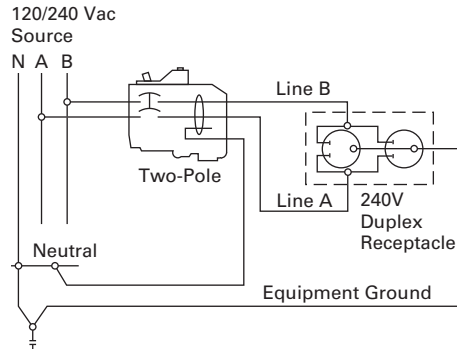

###### Single-Pole 120 V Load Application Sourced by 120/240 Vac

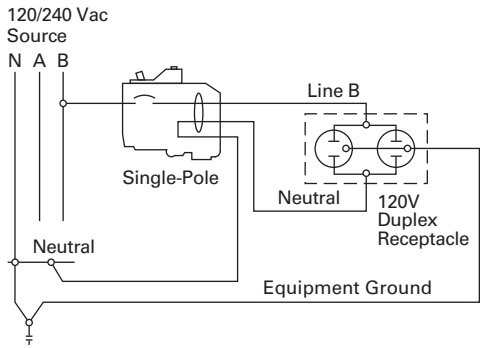

###### Two-Pole Shared Neutral with Duplex Receptacle Application

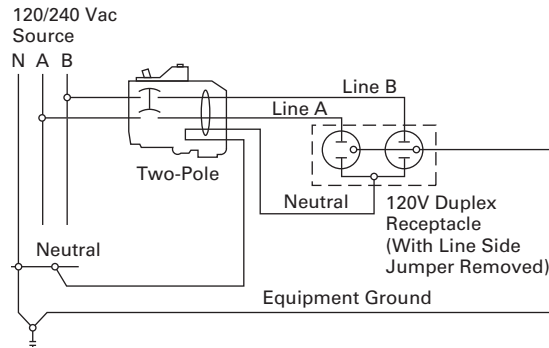

###### Two-Pole Shared Neutral with Multi-Duplex Receptacle Application

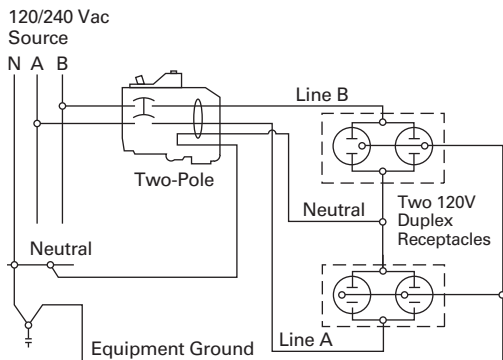

###### Single-Pole 120 V Duplex Receptacle Application

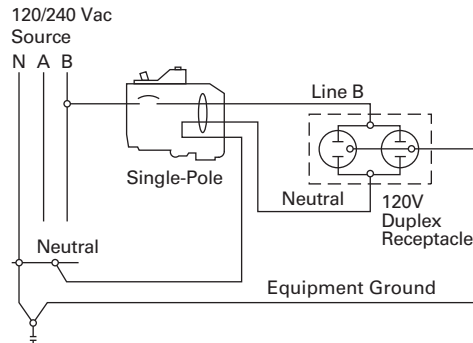

### Two-Pole 120 V Multi-Duplex Receptacle Application

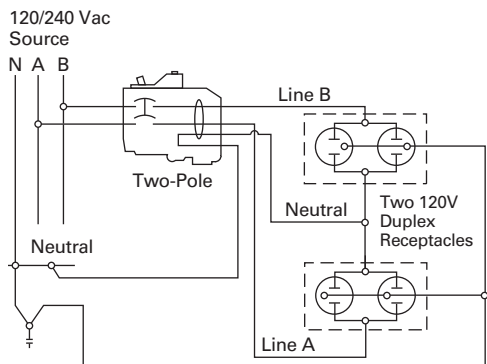

### Two-Pole 120 V Duplex Receptacle Application

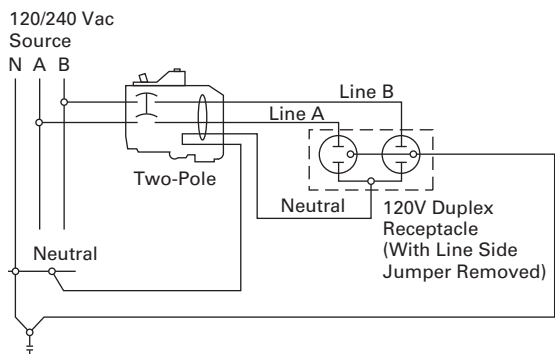

### Two-Pole 240 V Duplex Receptacle Application

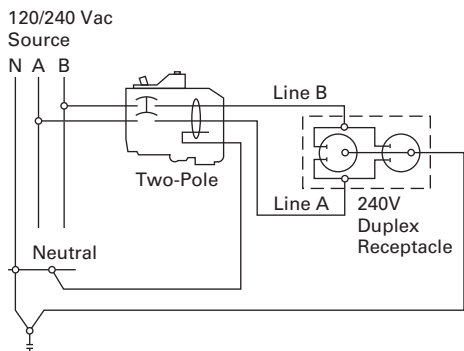

Type BR Loadcenters and Circuit Breakers



### Contents

<i>Description</i>	<i>Page</i>
Overview	
Standards and Certifications . . . . .	<b>V1-T1-43</b>
Catalog Number Selection . . . . .	<b>V1-T1-45</b>
Product Selection . . . . .	<b>V1-T1-46</b>
BR Specialty Products	
BR Plug-On Neutral Loadcenters . . . . .	<b>V1-T1-57</b>
BR Quick Connect Neutral Loadcenters . . . . .	<b>V1-T1-60</b>
Spa Panels . . . . .	<b>V1-T1-61</b>
Riser Panel . . . . .	<b>V1-T1-62</b>
Type BR Renovation Loadcenter . . . . .	<b>V1-T1-63</b>
BR Loadcenter Options and Accessories . . . . .	<b>V1-T1-66</b>
BR Circuit Breakers . . . . .	<b>V1-T1-80</b>

### Overview

#### Product Description

Loadcenters are enclosures specifically designed to house the branch circuit breakers and wiring required to distribute power to individual circuits. They contain either a main breaker when used at the service entrance point or a main lug when used as a sub-panel to add circuits to existing service. The main breaker protects the main entire panel and can be used as a service disconnect. The branch breakers protect the wires leading to individual electrical loads such as fixtures and outlets.

#### Features, Benefits and Functions

##### Loadcenter Construction

Eaton's Type BR loadcenters have standard tin-plated aluminum bus with a limited availability of copper bus. The sum of the handle ratings connected to any stab is limited to 150 A maximum on the 100 and 125 A loadcenters, and 200 A on loadcenters with 150 A or higher main bus. NEMA Type 1 boxes or enclosures are manufactured from galvanized steel. Raintight boxes are manufactured from galvanized steel, then finished using an electrostatic powder coat, baked urethane paint process.

##### Neutrals

Eaton Type CH loadcenters feature two types of neutrals:

##### Insulated/Bondable Split Neutral

Panels are supplied with split insulated neutrals with an insulated cross strap. For service entrance applications, the neutral must be bonded by using the bonding strap supplied with the panel. For non-service entrance (sub-panel) applications, the panel may be installed with the bonding strap not connected to the neutral. Separate ground bars must be used on non-service entrance panels.

##### Insulated/Bondable Single Neutral

Panels are supplied with a single insulated neutral. For service entrance applications, all that is required to bond the neutral is to loosen the bonding screw and the neutral screw directly beside it, insert the bonding strap into the neutral bar, and re-tighten both connections. The single neutral can be moved by the contractor to the other side of the panel, if desired. When used as a service entrance panel, unused neutral connections may be used for the termination of equipment grounds. For non-service entrance (sub-panel) applications, the panel may be installed with the bonding strap not connected to the neutral. Separate ground bars must be used on non-service entrance panels.

**Grounds**

In service entrance applications where the neutral is bonded, unused neutral holes may be used for terminating ground conductors. In sub-feed panels, the neutral must be isolated (non-bonded), and ground wires must be terminated on a separate ground bar.

The insulated/bondable single/split neutral panels have sufficient terminations for both ground and neutral conductors. The insulated/bondable single split neutral panels are supplied with a separate factory-installed ground bar if the catalog number contains a "G." If not, a separate ground bar should be installed. Insulated/Bondable Single Neutral panels are supplied without a ground bar (unless otherwise noted), and ground bar kits if needed must be purchased separately.

**Neutral and Ground Terminals**

The standard terminals on grounds and neutrals are rated to accept (3) #14–#10 Cu/Al or (1) #14–4, provided the cables terminated are of the same material. For larger cables, add-on neutral lugs may be ordered from the accessories on **Page V1-T1-71**.

**Note:** NEC allows only one current-carrying conductor per hole on neutrals unless otherwise noted.

**Bottom Fed Loadcenters**

For single-phase 225 A and below loadcenters that are bottom fed, a standard panel can be rotated 180 degrees to allow straight-in wiring of power cables to the main terminals. Because the main circuit breaker handle operates horizontally, the orientation of the main circuit breaker handle is consistent with the requirements of NEC 2008 Article 240.81.

**Gutter Splicing**

Loadcenters are not UL listed as wiring troughs. Therefore, gutter splicing of riser cables to tap off to the main device is not permitted. Refer to NEC 2008 Article 312.8.

**Fire Rating**

Due to the numerous openings in both loadcenter boxes and trims, they should not be mounted in firewalls. There is no approved method for sealing the enclosures for this application.

**Date Code**

The date of manufacture of each loadcenter is printed on the outside of the carton as well as inside the loadcenter. On the carton, the date code is printed on the end carton label. In the loadcenter, the date code is located on the small white label located on the right side wall (with the main device on top).

The date code is in the following format: F # # # &. The "F" is the numeric code for the Lincoln, IL plant, and the three numbers are the year and week of manufacturing, e.g., 023. The "!" sign at the end signifies the decade of the 2010. Therefore, the date code F023& would indicate that the product was manufactured in the 23rd week of 2010. The 1980s are represented by the "+" sign and the 1990s are represented by a "=" at the end of the code.

**Surge Protectors**

Complete home surge protection is available in multiple options, including a factory-installed option that provides the highest level of surge protection in a residential design. See Tab 3 for more details.

**Circuit Breaker Case Interrupting Capacity**

- 10 kAIC
- 22 kAIC
- 25 kAIC

**Warranty Information**

- 10-year limited loadcenter warranty
- 10-year limited branch breaker warranty

**Standards and Certifications****UL Listings**

All Eaton Type BR loadcenters are listed under UL File E52977 except the 2–8 circuit loadcenters, up through and including 125 A, which are listed under UL File E8741.



# 1.2

## Loadcenters and Circuit Breakers

### Type BR Loadcenters and Circuit Breakers

1

#### Type BR Loadcenter

Extra 1.5 inch Knockout (38.1 mm)

- Larger knockout provides easier installation and time savings

Top or Bottom Feed

- Straight-in wiring saves labor and material
- One panel for either top or bottom applications

2/0 Lug

- Easily removable and can be installed in any location on the neutral bar

Type BR AFCI Breakers

- Compact design for easier wiring and improved wireway access
- Optional LED indicates one of six trip codes for circuit diagnostics
- Provides a clean gutter space

Standard Tin-Plated Aluminum Bus

- Excellent conductivity and corrosion resistance
- Copper bus options available for select catalog numbers

Drywall Marking on Enclosure

- Indicates proper mounting depth for flush applications

"Tangential" Center Knockout

- Easier installation for conduit applications

Commercial Grade Main Breaker

- 25 kAIC series rated main breaker for superior protection

Neutral Bus (Strap)

- Is easily removable for sub-panel applications

Bonding Z-Strap

- Provides easy field conversion for service entrance applications

Twin Neutral Bars

- Minimum 150% neutral capacity

Steel Backpan

- Provides solid and reliable breaker mounting—single piece design for stability and durability

Single Keyhole Mounting

- One keyhole at the top and bottom provides easier mounting and leveling

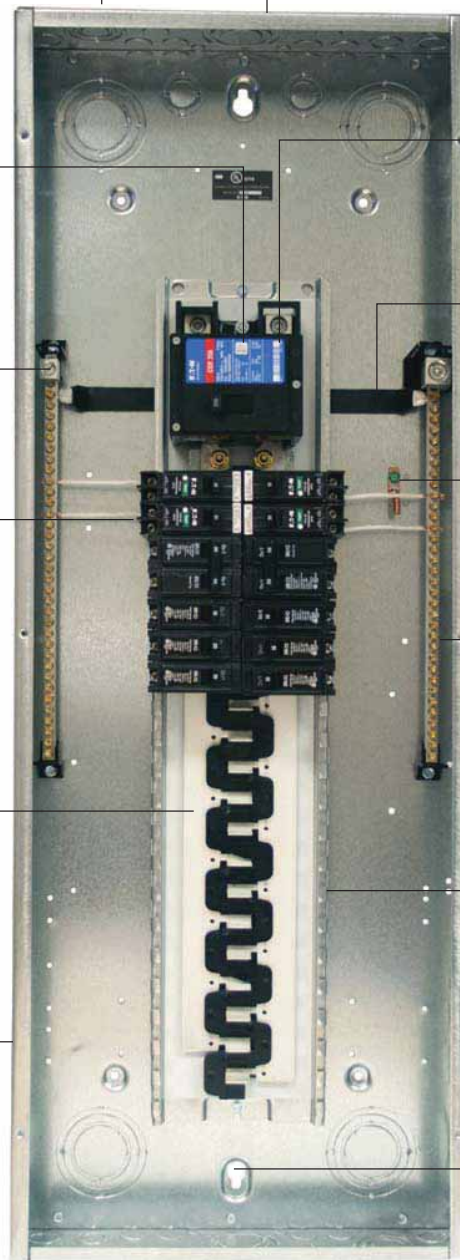

#### Warranty

10-year warranty on all Type BR loadcenters and circuit breakers.

### Catalog Number Selection

#### Single- and Three-Phase Through 600 A

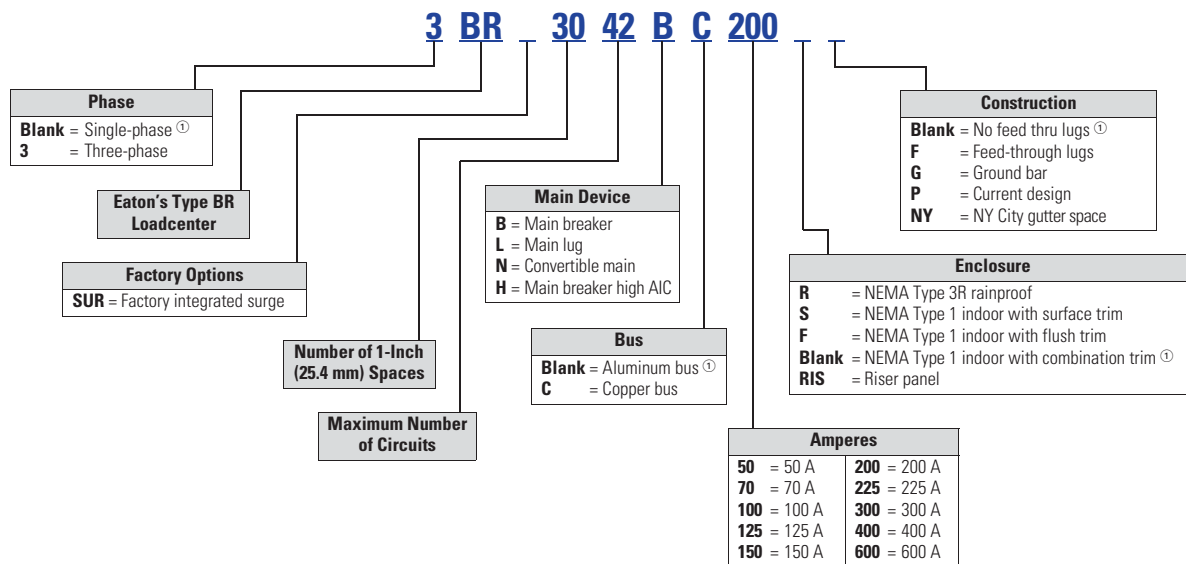

**Note**

① No character space used.

#### 1

#### Product Selection

##### Single-Phase—Main Circuit Breaker Loadcenters—10/25 kAIC

##### Single-Phase Three-Wire—120/240 Vac—Insulated/Bondable Split Neutral

Main Breaker Type	Main Ampere Rating	Maximum Number 1-Inch (25.4 mm)		Enclosure Type	Box Size	Wire Size Range Cu/Al 60 °C or 75 °C for Main Breaker	Loadcenter Catalog Number with Combination <sup>①</sup> or NEMA Type 3R Cover			
		Spaces	Circuits							
BR 10 kAIC	100	8	16	Indoor	B1	#4–1/0 <sup>②</sup>	BR816B100			
		10	20	Indoor	A1		BR1020B100S11			
		10	20	Indoor	A1		BR1020B100F11			
		10	20	Outdoor	B2R		BR1020B100RF <sup>③④</sup>			
		12	12	Indoor	B2		BR1212B100			
		12	20	Indoor	B2		BR1220B100			
		12	24	Outdoor	B2R		BR1224B100R <sup>④</sup>			
		16	16	Indoor	C1		BR1616B100			
		16	20	Indoor	C1		BR1620B100			
		16	24	Outdoor	C1R		BR1624B100R <sup>④</sup>			
		20	24	Outdoor	C3R		BR2024B100R <sup>④</sup>			
		20	20	Indoor	C2		BR2020B100			
		16	24	Indoor	C1		BR1624B100			
		30	30	Indoor	D1		BR3030B100			
			125	16	24		Indoor	C1	#4–2/0	BR1624B125
20	24			Indoor	C1	BR2024B125				
20	24			Outdoor	C3R	BR2024B125R <sup>④</sup>				
30	30			Indoor	D1	BR3030B125				
BRH <sup>⑤</sup> 22 kAIC	100	20	24	Indoor	C2	#4–1/0	BR2024H100 <sup>⑥</sup>			
CSR <sup>⑥</sup> 25 kAIC	150	8	16	Outdoor	C3R	#2–300 kcmil	BR816B150RF <sup>③④</sup>			
		16	30	Indoor	C4		BR1630B150			
		20	30	Indoor	C4		BR2030B150			
		20	30	Outdoor	D1R		BR2030B150R <sup>④</sup>			
		20	40	Indoor	D1		BR2040B150			
		20	40	Outdoor	D1R		BR2040B150R <sup>④</sup>			
		24	30	Indoor	G1		BR2430B150			
		30	30	Outdoor	G1R		BR3030B150R <sup>④</sup>			
		30	30	Indoor	G1		BR3030B150			
		30	40	Indoor	G1		BR3040B150			
			200	4	8		Outdoor	8R	#2–300 kcmil	BR48B200RF <sup>③⑦⑧</sup>
				8	16		Outdoor	C3R		BR816B200RF <sup>③④</sup>
16	32			Indoor	C4	BR1632B200				
20	40			Outdoor	D1R	BR2040B200R <sup>④</sup>				
20	40			Indoor	D1	BR2040B200				
24	40			Indoor	G1	BR2440B200				
30	40			Outdoor	G1R	BR3040B200R <sup>④</sup>				
40	40			Outdoor	L1R	BR4040B200R <sup>④</sup>				
60	120			Indoor	L3	BR60120B200				
	225	42	42	Indoor	L2	#1–250 kcmil	BR4242B225			
		42	42	Outdoor	L2R		BR4242B225R <sup>④</sup>			

#### Notes

- ① Combination style covers may be used in surface or flush applications.
- ② Wire range size for BR1020B100SP is #6–#1 Cu/Al.
- ③ Includes through-feed lugs for both phase and neutral conductors.
- ④ Rainproof panels are furnished with hub closure plates. For rainproof hubs, refer to **Page V1-T1-71**.
- ⑤ 22 kAIC series combination rating is obtained when Types BD, BR, BQ, BQC and GFTCB 10 kAIC branch breakers are used in series with Type BRH main breaker.
- ⑥ 25 kAIC series combination rating is obtained when Types BD, BR, BQ, BQC and GFTCB 10 kAIC branch circuit breakers are used in series with Type CSR main breaker.
- ⑦ Supplied with adapter plate to use DS Group1 hubs on **Page V1-T1-71**. If 2.50-inch (63.5 mm) hub is needed, remove adapter and use ARP00007CH25 hub.
- ⑧ Neutral is bonded—suitable for service entrance only—cannot be converted for sub-feed application.

All main circuit breaker loadcenters are listed for use as service entrance equipment and are shipped with neutral bonding strap preattached. The maximum rating of the panel is the main circuit breaker rating when used as service entrance equipment. Ground bar kits priced separately. See **Page V1-T1-71**.

### Main Circuit Breaker Loadcenters—10/22 kAIC

B4242DFN



### Single-Phase Three-Wire—120/240 Vac—Insulated/Bondable Split Neutral

Main Breaker Type	Main Ampere Rating	Maximum Number 1-Inch (25.4 mm)		Enclosure Type	Box Size	Wire Size Range Cu/Al 60 °C or 75 °C for Main Breaker	Commercial Loadcenter Catalog Number <sup>①②③</sup>	
		Spaces	Circuits				With Flush or NEMA Type 3R Cover	With Surface Cover
DK <sup>④</sup>	300	42	42	Indoor	24	(2) #3/0–250 kcmil	BR4242B300F	BR4242B300S
	400	42	42	Indoor	24	(2) #3/0–250 kcmil	BR4242B400F	BR4242B400S
		42	42	Outdoor	47	(2) #3/0–250 kcmil	BR4242B400R <sup>⑤</sup>	—
HLD <sup>⑥</sup>	600	42	42	Indoor	24	(2) #3/0–500 kcmil	—	BR4242B600S

#### Notes

- ① Ground bar kits priced separately. See **Page V1-T1-71**.
- ② The maximum rating of the panel is the main circuit breaker rating when used as service entrance equipment.
- ③ Door lock and key included with loadcenter.
- ④ Type DK main circuit breaker is rated 65 kAIC at 240 Vac and allows a 22 kAIC series rating on the panel when Types BR, BD and BJ branch circuit breakers are used.
- ⑤ Rainproof panels are furnished with hub closure plates. For rainproof hubs, refer to **Page V1-T1-71**.
- ⑥ Type HLD main circuit breaker is rated 65 kAIC at 240 Vac. Type HLD circuit breaker **is not** series rated with Types BR, BD and BJ branch circuit breakers.

Box sizes **Pages V1-T1-76 through V1-T1-79**.

Please contact the Lincoln Flex Center for any configurations not listed.



#### Single-Phase—Main Lug Loadcenters

#### Single-Phase Three-Wire—120/240 Vac—Insulated/Bondable Split Neutral

Main Ampere Rating	Maximum Number 1-Inch (25.4 mm)		Enclosure Type	Trim Type	Box Size	Wire Size Range Cu/Al 60 °C or 75 °C for Main Lugs	Loadcenter Catalog Number
	Spaces	Circuits					
70	Surface	Outdoor	Indoor	Surface (no door)	5	#8-#2	BR24L70SP ①②
			Indoor	Surface (no door)	5		BR24L70SGP ②③
	Outdoor	—	5R	BR24L70RP ①②④			
	Indoor	Flush (no door)	5	BR24L70FP ①②			
	Indoor	Flush (no door)	5	BR24L70FGP ②⑤			
125	Flush	Outdoor	Indoor	Surface (no door)	6	#14-1/0	BR24L125SP ①②
			Outdoor	—	6R		BR24L125RP ①②④
	Surface (No Door)	Outdoor	Indoor	—	6R	#14-1/0	BR24L125RSEP ②⑦⑧
			Indoor	—	6R		BR24L125RSE2P ②⑥⑦
	Flush (No Door)	Outdoor	Indoor	Flush (no door)	6	#14-1/0	BR24L125FP ①②
			Indoor	Surface (no door)	7		BR48L125SP ①⑨
			Indoor	Surface (no door)	7		BR48L125SGP ③⑨
			Outdoor	—	7R		BR48L125RP ①④⑨
			Indoor	Flush (no door)	7		BR48L125FP ①⑨
			Indoor	Flush (with door)	7		BR48L125FDP ①⑨
			Indoor	Flush (no door)	7		BR48L125FGP ③⑨
			Indoor	Surface (no door)	7		#14-#1
	Indoor	Surface (no door)	7	BR612L125SGP ⑩⑪			
	Outdoor	Outdoor	Indoor	Surface (with door)	7	#14-#1	BR612L125SDP ①⑩
			Indoor	Surface (with door)	7		BR612L125SDGP ⑩⑪
			Outdoor	—	7R		BR612L125RP ①④⑩
			Indoor	Flush (no door)	7		BR612L125FP ①⑩
			Indoor	Flush (no door)	7		BR612L125FGP ⑤⑩⑪
			Indoor	Flush (with door)	7		BR612L125FDP ⑩
			Indoor	Flush (with door)	7		BR612L125FDGP ⑤⑩⑪
Indoor			Surface (no door)	7	#14-#1		BR816L125SP ①⑩
Indoor	Surface (no door)	7	BR816L125SGP ⑩⑫				
Outdoor	Outdoor	Indoor	Surface (with door)	7	#14-#1	BR816L125SDP ①⑩	
		Indoor	Surface (with door)	7		BR816L125SDGP ⑩⑫	
		Outdoor	—	7R		BR816L125RP ①④⑩	
		Indoor	Flush (no door)	7		BR816L125FP ①⑩	
		Indoor	Flush (no door)	7		BR816L125FGP ⑤⑩⑫	
		Indoor	Flush (with door)	7		BR816L125FDP ①⑩	
		Indoor	Flush (with door)	7		BR816L125FDGP ⑤⑩⑪	
		Indoor	Flush (with door)	7		BR816L125FDGP ⑤⑩⑪	



#### Notes

- ① Ground bar kits priced separately. See **Page V1-T1-71**.
  - For 2/4 circuit loadcenters, use GBK5 or GBK520 ground bar.
  - For 4/8, 6/12 and 8/16 circuit loadcenters, use GBK10 ground bar.
  - Ground bars mount to the left side wall of the enclosure for the 4/8, 6/12 and 8/16 circuit loadcenters.
- ② Suitable for use as service equipment when not more than two service disconnecting mains are provided or when not used as a lighting and appliance panelboard.
- ③ Ground bar GBK5 is installed.
- ④ Rainproof panels are furnished with hub closure plates. For rainproof hubs, refer to **Page V1-T1-71**.
- ⑤ CSA and UL approved.
- ⑥ Neutral/ground holes (6) #14-6 and (3) #14-2/0 AWG Cu/Al.
- ⑦ For use as service entrance applications only.
- ⑧ Neutral/ground holes (6) #14-6 and (3) #14-1/0 AWG Cu/Al.
- ⑨ Suitable for use as service equipment when not more than two service disconnecting mains are provided or when not more than six service disconnecting mains are provided and when not used as a lighting and appliance panelboard.
- ⑩ Suitable for use as service equipment when a main breaker is used or when not more than six service disconnecting mains are provided and when not used as a lighting and appliance panelboard.
- ⑪ Ground bar GBK10 is installed.
- ⑫ Ground bar GBK14 is installed.

Box sizes **Pages V1-T1-76 through V1-T1-79**.

### Single-Phase—Main Lug Loadcenters

#### Single-Phase Three-Wire—120/240 Vac—Insulated/Bondable Split Neutral, continued

Main Ampere Rating	Maximum Number 1-Inch (25.4 mm)		Enclosure Type	Box Size	Wire Size Range Cu/Al 60 °C or 75 °C for Main Lugs	Loadcenter Catalog Number with Combination or NEMA Type 3R Cover ①			
	Spaces	Circuits							
<b>BR1224L125</b> 	125	12	12	Indoor	#6–2/0	<b>BR1212L125</b> ②③④⑤			
		12	24	Indoor		<b>BR1224L125</b> ②④⑤			
		12	24	Indoor		<b>BR1224L125G</b> ②④⑤			
		12	24	Indoor		<b>BR1224L125DG</b> ②④⑤⑥			
		12	24	Outdoor		<b>BR1224L125R</b> ②⑤⑦			
		16	16	Indoor		<b>BR1616L125</b> ②④⑤			
		16	24	Indoor		<b>BR1624L125</b> ②④			
		16	24	Indoor		<b>BR1624L125G</b> ②④			
		16	24	Outdoor		<b>BR1624L125R</b> ②⑦			
		20	20	Indoor		<b>BR2020L125</b> ②④⑤			
		20	24	Indoor		<b>BR2024L125</b> ②④			
		20	24	Indoor		<b>BR2024L125G</b> ②④⑧			
		20	24	Outdoor		<b>BR2024L125R</b> ②⑦			
		24	24	Indoor		<b>BR2424L125</b> ②④			
		24	24	Indoor		<b>BR2424L125G</b> ②④⑧			
		30	42	Indoor		<b>BR3042L125</b> ②④			
		150	16	30		Indoor	C2	#1–300 kcmil	<b>BR1630L150</b> ④⑨
			20	30		Indoor			<b>BR2030L150</b> ④⑨
<b>BR1224L200</b> 	200	8	16	Outdoor	#1–300 kcmil	<b>BR816L200RF</b> ⑤⑦⑩			
		12	24	Indoor		<b>BR1224L200</b> ④⑤⑨			
		12	24	Outdoor		<b>BR1224L200R</b> ⑤⑦⑨			
		20	40	Indoor		<b>BR2040L200</b> ④⑨			
		20	40	Indoor		<b>BR2040L200G</b> ④⑧⑨			
		20	40	Outdoor		<b>BR2040L200R</b> ⑦⑨			
		24	40	Indoor		<b>BR2440L200</b> ④⑨			
		30	40	Indoor		<b>BR3040L200</b> ④⑨			
		30	40	Outdoor		<b>BR3040L200R</b> ⑦⑨			
		40	40	Indoor		<b>BR4040L200</b> ④⑨			
		40	40	Indoor		<b>BR4040L200G</b> ④⑨			
		40	40	Outdoor		<b>BR4040L200R</b> ⑦⑨			
		60	120	Indoor		<b>BR60120L200</b> ⑩			
		225	42	42		Indoor	L1	#1–300 kcmil	<b>BR4242L225</b> ④
42	42		Outdoor	<b>BR4242L225R</b> ⑦					

#### Notes

- ① Ground bar kits priced separately unless otherwise noted. See **Page V1-T1-71**.
- ② Has notch for BREQS125 hold-down kit.
- ③ Single, movable neutral is provided.
- ④ Combination cover style.
- ⑤ Suitable for use as service equipment when not more than six main disconnecting means are provided and when not used as a lighting and appliance panelboard.
- ⑥ Ground bars GBK5 and GBK520 installed.
- ⑦ Rainproof panels are furnished with hub closure plates. For rainproof hubs, refer to **Page V1-T1-71**.
- ⑧ Ground bar GBK1220 installed.
- ⑨ Has notch for BRHDK125 hold-down kit.
- ⑩ Includes through-feed lugs for both phase and neutral conductors.
- ⑪ Includes main lugs. Loadcenters can convert to main breaker using kit.

# 1.2

## Loadcenters and Circuit Breakers

### Type BR Loadcenters and Circuit Breakers

1

#### Single-Phase—Main Lug Loadcenters—400 and 600 A

4242DFN



#### Single-Phase Three-Wire—120/240 Vac—Insulated/Bondable Split Neutral

Main Ampere Rating	Maximum Number 1-Inch (25.4 mm)		Enclosure Type	Box Size	Wire Size Range Cu/Al 60 °C or 75 °C for Main Lugs	Commercial Loadcenter Catalog Number <sup>①②③</sup>	
	Spaces	Circuits				With Flush or NEMA Type 3R Cover	With Surface Cover
400	12	24	Outdoor	42	(2) #3/0–400 kcmil	BR1224L400R <sup>④⑤</sup>	—
	42	42	Indoor	22		BR4242L400F	BR4242L400S
	42	42	Outdoor	46		BR4242L400R <sup>④</sup>	—
600	42	42	Indoor	22	(2) #2–500 kcmil	—	BR4242L600S

#### Notes

- ① Ground bar kits priced separately unless otherwise noted. See **Page V1-T1-71**.
- ② Has notch for BRHDK125 hold-down kit.
- ③ Ground bar GBK8 installed.
- ④ Rainproof panels are furnished with hub closure plates. For rainproof hubs, refer to **Page V1-T1-71**.
- ⑤ Suitable for use as service equipment when not more than six main disconnecting means are provided and when not used as a lighting and appliance panelboard.

**Convertible Loadcenters MCB or MLO—Base Units and Main Devices 10/22/25 kAIC, Complete Assembly Consists of: Loadcenter and Either Main Breaker Kit or Main Lug Kit**

**Note:** Interrupting rating depends on main circuit breaker selected.

BR3040N200



**Base Units—Single-Phase Three-Wire—120/240 Vac—Insulated/Bondable Split Neutral (Unless Otherwise Noted)**

Main Ampere Rating ①	Maximum Number 1-Inch (25.4 mm)		Enclosure Type	Box Size	Wire Size Range Cu/Al 60 °C or 75 °C for Main	Loadcenter Catalog Number With Combination or NEMA Type 3R Cover ②③
	Spaces	Circuits				
125 ④	12	24	Indoor	B2	See main breaker and main lug kit tables <b>Page V1-T1-54.</b>	BR1224N125 ⑤⑥
	12	24	Outdoor	B2R		BR1224N125R ⑤⑥⑦
	16	24	Indoor	C1		BR1624N125 ⑤
	16	24	Outdoor	C1R		BR1624N125R ⑤⑦
	20	24	Indoor	C2		BR2024N125 ⑤
	20	24	Outdoor	C3R		BR2024N125R ⑤⑦
200 ⑧	8	16	Outdoor	C3R	BR816N200RF ⑦⑨⑩⑪	
	12	24	Indoor	C4	BR1224N200 ⑩	
	12	24	Outdoor	C3R	BR1224N200R ⑦⑩	
	16	32	Indoor	C4	BR1632N200 ⑩	
	20	40	Indoor	D1	BR2040N200 ⑩	
	20	40	Indoor	D1	BR2040N200G ⑫	
	20	40	Outdoor	D1R	BR2040N200R ⑦⑩	
	20	40	Outdoor	D1R	BR2040N200RG ⑫	
	24	40	Indoor	G1	BR2440N200 ⑦⑩	
	30	40	Indoor	G1	BR3040N200 ⑩	
	30	40	Indoor	G1	BR3040N200G ⑫	
	30	40	Outdoor	G1R	BR3040N200R ⑦⑩	
	30	40	Outdoor	G1R	BR3040N200RG ⑫	
	40	40	Indoor	L1	BR4040N200G ⑫	
	40	40	Outdoor	L1R	BR4040N200R ⑦⑩	
	40	40	Outdoor	L1R	BR4040N200RG ⑫	
40	50	Indoor	L1	BR4050N200		
40	50	Outdoor	L1R	BR4050N200R		

**Notes**

- ① The maximum rating of the loadcenter is the main circuit breaker rating when used as service entrance equipment.
- ② 100, 125 and 200 A convertible base unit catalog numbers include interior, box and cover only. Main devices and accessories must be ordered separately for field installation. All convertible base units are listed as suitable for use as service entrance equipment when used per Article 408 of the NEC.
- ③ Ground bar kits priced separately except as noted, refer to **Page V1-T1-71.**
- ④ For main breaker, use Type BR. For main lug use Type BRSF.
- ⑤ BREQS125 hold-down screw comes with loadcenter for back-fed Types BR and BRH main circuit breakers.
- ⑥ Convertible to maximum of 100 A main circuit breaker and 125 A main lug.
- ⑦ Rainproof loadcenters are furnished with hub closure plates. For rainproof hubs, refer to **Page V1-T1-71.**
- ⑧ For main breaker, use Type BW or CSR. For main lug, use Type BRL.
- ⑨ Includes through-feed lugs for both phase and neutral conductors.
- ⑩ No hold-down provisions for back-fed Types BR and BRH main circuit breakers.
- ⑪ Insulated/bondable single neutral.
- ⑫ Includes GBK2120 ground bar.

# 1.2

## Loadcenters and Circuit Breakers

### Type BR Loadcenters and Circuit Breakers

1

#### Convertible Loadcenters MCB or MLO—Base Units and Main Devices 10/22/25 kAIC, Complete Assembly Consists of: Loadcenter and Either Main Breaker Kit or Main Lug Kit

**Note:** Interrupting rating depends on main circuit breaker selected.

#### BW2200



#### Main Devices—Two- and Three-Pole Main Circuit Breakers—120/240 Vac or 208Y/120 Vac or 240 Vac

Ampere Rating	Wire Size Range Cu/Al 60 °C or 75 °C for Main Breaker	10 kAIC Catalog Number	22/25 kAIC Catalog Number ①
<b>Two-Pole</b>			
100	#4–1/0	BR2100	BRH2100
110	#4–1/0	BR2110	BRH2110
125	#4–2/0	BR2125	BRH2125
125	#2–300 kcmil	BW2125	CSR2125N
150	#2–300 kcmil	BW2150	CSR2150N
175	#2–300 kcmil	BW2175	CSR2175N
200	#2–300 kcmil	BW2200	CSR2200N
<b>Three-Pole</b>			
100	#1	BR3100	BRH3100

#### BRL200



#### Main Devices—Two- and Three-Pole Main Lug Kits—120/240 Vac or 208Y/120 Vac or 240 Vac

Ampere Rating	Wire Size Range Cu/Al 60 °C or 75 °C for Main Lugs	Catalog Number
<b>Two-Pole</b>		
125	#6–2/0	BRSF125
150	#1–300 kcmil	BRL200
175	#1–300 kcmil	BRL200
200	#1–300 kcmil	BRL200
<b>Three-Pole</b>		
150	#6–3/0	3BRSF150

#### Main Circuit Breaker with Accessory

Example: BW22005R01 (Put description with catalog number on order. See **Page V1-T1-90**.)

#### Main Circuit Breaker Loadcenters—Copper Bus 10/22/25 kAIC

#### BR3030BC100



#### Main Circuit Breaker Loadcenters—With Copper Bus—Single-Phase Three-Wire—120/240 Vac—Insulated/Bondable Split Neutral

Main Breaker Type	Main Ampere Rating	Maximum Number 1-Inch (25.4 mm)		Enclosure Type	Box Size	Wire Size Range Cu/Al 60 °C or 75 °C for Main Breaker	Loadcenter Catalog Number with Combination Cover ②③
		Spaces	Circuits				
BR 10 kAIC	100	20	20	Indoor	C2	#4–1/0	BR2020BC100
		30	30	Indoor	D1	#4–1/0	BR3030BC100
BRH 22 kAIC ④	100	30	30	Indoor	D1	#4–1/0	BR3030HC100
		150		30	30	Indoor	G1
CSR 25 kAIC	200	20	40	Indoor	D1	#2–300 kcmil	BR2040BC200
		30	40	Indoor	G1	#2–300 kcmil	BR3040BC200
		40	40	Indoor	L1	#2–300 kcmil	BR4040BC200

#### Main Lug Only Loadcenters—Copper Bus

#### BR816LC125FDP



#### Single-Phase Three-Wire—120/240 Vac—Insulated/Bondable Single Neutral with Copper Bus

Main Ampere Rating	Maximum Number 1-Inch (25.4 mm)		Enclosure Type	Trim Type	Box Size	Wire Size Range Cu/Al 60 °C or 75 °C for Main Lugs	Loadcenter Catalog Number
	Spaces	Circuits					
125	8	16	Indoor	Surface (with door)	7	#14–1	BR816LC125SDP
	8	16	Indoor	Flush (with door)	7		BR816LC125FDP

#### Notes

- ① Series combination rating with Types BD, BR, BQ, BQC and GFTCB is 22 kAIC with BRH main and 25 kAIC with CSR main.
  - ② All main circuit breaker loadcenters are listed for use as service entrance equipment and are shipped with neutral bonding strap preattached. The maximum rating of the panel is the main circuit breaker rating when used as service entrance equipment.
  - ③ Ground bar kits priced separately. See **Page V1-T1-71**.
  - ④ 22 kAIC series combination rating is obtained when Types BD, BR, BQ, BQC and GFTCB 10 kAIC branch breakers are used in series with Type BRH main breaker.
- Box sizes **Pages V1-T1-76** through **V1-T1-79**.

### Convertible Loadcenters—Copper Bus 10/22/25 kAIC

BR3040NC200



### Convertible—Single-Phase, Three-Wire—120/240 Vac—Insulated/Bondable Split Neutral

Main Ampere Rating	Maximum Number 1-Inch (25.4 mm)		Enclosure Type	Box Size	Wire Size Range Cu/Al 60 °C or 75 °C for Main	Loadcenter Catalog Number (With Combination or NEMA Type 3R Cover) ①②③
	Spaces	Circuits				
125 10/22 kAIC ④⑤	12	24	Indoor	B2	See main breaker and main lug kit tables on <b>Page V1-T1-54</b> .	<b>BR1224NC125</b> ⑥⑦
	12	24	Outdoor	B2R		<b>BR1224NC125R</b> ⑥⑦⑧
	20	24	Indoor	C2		<b>BR2024NC125</b> ⑦
	20	24	Outdoor	C3R		<b>BR2024NC125R</b> ⑦⑧
200 10/25 kAIC ④⑤	20	40	Indoor	D1	<b>BR2040NC200</b>	
	20	40	Outdoor	D1R	<b>BR2040NC200R</b> ⑧	
	30	40	Indoor	G1	<b>BR3040NC200</b>	
	30	40	Outdoor	G1R	<b>BR3040NC200R</b> ⑧	
	40	40	Indoor	L1	<b>BR4040NC200</b>	
	40	40	Outdoor	L1R	<b>BR4040NC200R</b> ⑧	

#### Notes

- ① 100, 125 and 200 A convertible base unit catalog numbers include interior, box and cover only. Main devices and accessories must be ordered separately for field installation. All convertible base units are listed as suitable for use as service entrance equipment when used per Article 384 of the NEC.
- ② Ground bar kits priced separately, refer to **Page V1-T1-71**.
- ③ All main circuit breaker loadcenters are listed for use as service entrance equipment and are shipped with a neutral bonding strap preattached. The maximum main rating of the loadcenter is the main breaker rating when used as service entrance equipment.
- ④ Interrupting rating depends on main circuit breaker selected. See **Page V1-T1-71** for mains.
- ⑤ For main breaker, use Type BW or CSR. For main lug, use Type BRL.
- ⑥ Rainproof loadcenters are furnished with hub closure plates. For rainproof hubs, refer to **Page V1-T1-71**.
- ⑦ Hold-down screw BREQS125 comes with loadcenter for back-fed Types BR and BRH main circuit breakers.
- ⑧ For main breaker, use Type BR. For main lug, use Type BRSF.
- ⑨ Suitable for use as service equipment when not more than six main disconnecting means are provided and when not used as a lighting and appliance panelboard.

#### 1 Three-Phase—Type BR Main Circuit Breaker Loadcenters

#### Three-Phase, Four-Wire—Main Lug Loadcenters—Copper Bus—208Y/120 Vac or 240 Vac, Insulated/Bondable Split Neutral

Main Ampere Rating	Maximum Number 1-Inch (25.4 mm)		Enclosure Type	Box Size	Wire Size Range Cu/Al 60 °C or 75 °C for Main	Loadcenter Catalog Number (With Combination or NEMA Type 3R Cover)
	Spaces	Circuits				
125	12	24	Indoor	C1	#6–3/0	3BR1224LC125
125	12	24	Outdoor	C1R	#6–3/0	3BR1224LC125R
150	24	42	Indoor	D1	#4–300 kcmil	3BR2442LC150
150	24	42	Outdoor	D1R	#4–300 kcmil	3BR2442LC150R
200	12	24	Indoor	C4	#4–300 kcmil	3BR1224LC200
200	12	24	Outdoor	C3R	#4–300 kcmil	3BR1224LC200R
200	30	42	Indoor	G1	#4–300 kcmil	3BR3042LC200
200	30	42	Outdoor	G1R	#4–300 kcmil	3BR3042LC200R
200	42	42	Indoor	L1	#4–300 kcmil	3BR4242LC200
200	42	42	Outdoor	L1R	#4–300 kcmil	3BR4242LC200R
225	30	42	Indoor	L1	#4–300 kcmil	3BR3042LC225
225	30	42	Outdoor	L1R	#4–300 kcmil	3BR3042LC225R
400	42	42	Indoor	24	(2) 3/0–250 kcmil	3BR4242LC400S
	42	42	Outdoor	47		3BR4242BC400R
600	42	42	Indoor	24	(2) 3/0–500 kcmil	3BR4242LC600S

#### Three-Phase, Four-Wire—Main Circuit Breaker Loadcenters—Copper Bus—208Y/120 Vac or 240 Vac, Insulated/Bondable Split Neutral

Main Breaker Type	Main Ampere Rating	Maximum Number 1-Inch (25.4 mm)		Enclosure Type	Box Size	Wire Size Range Cu/Al 60 °C or 75 °C for Main Breaker	Loadcenter Catalog Number (With Combination or NEMA Type 3R Cover)
		Spaces	Circuits				
BR 10 kAIC	100	12	24	Indoor	C1	#14–1/0	3BR1224BC100
	100	12	24	Outdoor	C1R	#14–1/0	3BR1224BC100R
CC 10 kAIC	150	30	42	Indoor	L1	#6–4/0	3BR3042BC150
	150	30	42	Outdoor	L1R	#6–4/0	3BR3042BC150R
	200	42	42	Indoor	L2	2/0–300 kcmil	3BR4242BC200
	200	42	42	Outdoor	L2R	2/0–300 kcmil	3BR4242BC200R
	225	42	42	Indoor	L2	2/0–300 kcmil	3BR4242BC225
	225	42	42	Outdoor	L2R	2/0–300 kcmil	3BR4242BC225R
DK 22 kAIC	400	42	42	Indoor	24	(2) 3/0–250 kcmil	3BR4242BC400S
		42	42	Outdoor	47		3BR4242BC400R
HLD 10 kAIC	600	42	42	Indoor	24	(2) 3/0–500 kcmil	3BR4242BC600S

3BR4242B200



#### Three-Phase, Four-Wire—Main Circuit Breaker Loadcenters—Aluminum Bus—208Y/120 Vac or 240 Vac Insulated/Bondable Split Neutral

Main Breaker Type	Main Ampere Rating	Maximum Number 1-Inch (25.4 mm)		Enclosure Type	Box Size	Wire Size Range Cu/Al 60 °C or 75 °C for Main Breaker	Loadcenter Catalog Number <sup>(1)(2)</sup> (With Combination or NEMA Type 3R Cover)
		Spaces	Circuits				
BR 10 kAIC	100	12	24	Indoor	C1	#14–1/0	3BR1224B100
		12	24	Outdoor	C1R		3BR1224B100R <sup>(3)</sup>
CC 10 kAIC	125	30	42	Indoor	L1	#6–4/0	3BR3042B125
		30	42	Outdoor	L1R		3BR3042B150R <sup>(3)</sup>
	200	30	42	Indoor	L1	#1–250 kcmil	3BR3042B200
		30	42	Outdoor	L1R		3BR3042B200R <sup>(3)</sup>
		42	42	Indoor	L2		3BR4242B200
		42	42	Outdoor	L2R		3BR4242B200R <sup>(3)</sup>
CHH 100 kAIC	200	42	42	Indoor	L2	2/0–300 kcmil	3BR4242H200 <sup>(6)</sup>
CC 10 kAIC	225	42	42	Indoor	L2	2/0–300 kcmil	3BR4242B225
		42	42	Outdoor	L2R		3BR4242B225R <sup>(3)</sup>
DK <sup>(4)</sup> 22 kAIC	400	42	42	Indoor	24	(2) #3/0–250 kcmil	3BR4242B400S <sup>(7)</sup>
		42	42	Indoor	24		3BR4242B400F
		42	42	Outdoor	47		3BR4242B400R <sup>(3)</sup>
LD <sup>(5)</sup>	600	42	42	Indoor	24	(2) #3/0–500 kcmil	3BR4242B600F

#### Notes

- <sup>(1)</sup> All main circuit breaker loadcenters are listed for use as service entrance equipment and are shipped with a neutral bonding strap pre-attached (commercial loadcenters do not have a pre-attached bonding strip). The maximum main rating of the panel is the main circuit breaker rating when used as service entrance equipment.
- <sup>(2)</sup> Ground bar kits priced separately. See **Page V1-T1-71**.
- <sup>(3)</sup> Rainproof loadcenters are furnished with hub closure plates. For rainproof hubs, refer to **Page V1-T1-71**.
- <sup>(4)</sup> Type DK main circuit breaker is rated 65 kAIC at 240 Vac and allows a 22 kAIC series rating on the loadcenter when Types BR, BD and BJ branch circuit breakers are used.
- <sup>(5)</sup> The LD main circuit breaker is rated 65 kAIC at 240 Vac. Type LD circuit breaker **is not** series rated with Types BR, BD and BJ branch circuit breakers.
- <sup>(6)</sup> Includes CHH 100 kAIC rated MCB. 100 kAIC series rating combination is obtained when types BD, BR, BQ, BQC and GFGB branch breakers are used with CHH main.
- <sup>(7)</sup> With surface cover.

### 3BR1224L125



### Three-Phase, Four-Wire—Main Lug Loadcenters—Aluminum Bus—208Y/120 Vac or 240 Vac, Insulated/Bondable (Unless Otherwise Noted)

Main Ampere Rating	Maximum Number 1-Inch (25.4 mm)		Enclosure Type	Box Size	Wire Size Range Cu/Al 60 °C or 75 °C for Main Lugs	Loadcenter Catalog Number <sup>①</sup> (With Combination or NEMA Type 3R Cover)
	Spaces	Circuits				
100	3	3	Indoor	6	#6-1/0	3BR3L100S <sup>②③</sup>
	3	3	Outdoor	6R		3BR3L100R <sup>③④</sup>
125	12	24	Indoor	C1	#6-3/0	3BR1224L125 <sup>⑤⑥</sup>
	12	24	Outdoor	C1R		3BR1224L125R <sup>④⑤⑥</sup>
150	18	36	Indoor	C2	#6-4/0	3BR1836L150
	18	36	Outdoor	C3R		3BR1836L150R
	24	42	Indoor	D1	#4-300 kcmil	3BR2442L150
	24	42	Outdoor	D1R		3BR2442L150R <sup>④</sup>
200	12	24	Indoor	C4	#4-300 kcmil	3BR1224L200 <sup>⑥</sup>
	12	24	Outdoor	C3R		3BR1224L200R <sup>④⑥</sup>
	18	36	Indoor	C4	#4-300 kcmil	3BR1836L200
	18	36	Outdoor	C3R		3BR1836L200R
	30	42	Indoor	G1	#4-300 kcmil	3BR3042L200
	30	42	Outdoor	G1R		3BR3042L200R <sup>④</sup>
	42	42	Indoor	L1	#4-300 kcmil	3BR4242L200
	42	42	Outdoor	L1R		3BR4242L200R <sup>④</sup>
225	42	42	Indoor	L1	#4-300 kcmil	3BR4242L225
	42	42	Outdoor	L1R		3BR4242L225R <sup>④</sup>

### 3BR4242L400F



### Three-Phase, Four-Wire—Main Lug Loadcenters—Aluminum Bus—208Y/120 Vac or 240 Vac, Insulated/Bondable Split Neutral

Main Ampere Rating	Maximum Number 1-Inch (25.4 mm)		Enclosure Type	Box Size	Wire Size Range Cu/Al 60 °C or 75 °C for Main Lugs	Commercial Loadcenter Catalog Number <sup>⑦</sup>	
	Spaces	Circuits				With Flush or NEMA Type 3R Cover	With Surface Cover
400	42	42	Indoor	22	(1) 250-750 kcmil	3BR4242L400F	3BR4242L400S
	42	42	Outdoor	46	or (2) #3/0-250 kcmil	3BR4242L400R <sup>④</sup>	—
600	42	42	Indoor	22	(2) #2-500 kcmil	—	3BR4242L600S

#### Notes

- ① Ground bar kits priced separately. See **Page V1-T1-71**.
- ② Surface cover only.
- ③ Insulated/bondable single neutral.
- ④ Rainproof loadcenters are furnished with hub closure plates. For rainproof hubs, refer to **Page V1-T1-71**.
- ⑤ Has notch for BREQS125 hold-down kit.
- ⑥ Suitable for use as service equipment when not more than six main disconnecting means are provided and when not used as a lighting and appliance panelboard.
- ⑦ Door lock and key included with loadcenter.

Box sizes **Pages V1-T1-76** through **V1-T1-79**.



# 1.2

## Loadcenters and Circuit Breakers

### Type BR Loadcenters and Circuit Breakers

1

3BR3030N100



3BR4242N225NY



### Three-Phase, Four-Wire—Convertible Loadcenters—Aluminum Bus—208Y/120 Vac or 240 Vac, Insulated/Bondable Split Neutral

Main Ampere Rating <sup>①</sup>	Maximum Number 1-Inch (25.4 mm)		Enclosure Type	Box Size	Wire Size Range Cu/Al 60 °C or 75 °C for Main	Loadcenter Catalog Number <sup>②③</sup> (With Combination or NEMA Type 3R Cover)
	Spaces	Circuits				
100 <sup>④</sup>	30	30	Indoor	D1	See main breaker and main lug kit tables below.	3BR3030N100 <sup>⑤</sup>
	30	30	Outdoor	D1R		3BR3030N100R <sup>⑤⑥</sup>
125 <sup>④</sup>	12	24	Indoor	C1		3BR1224N125 <sup>⑤⑥⑦</sup>
	12	24	Outdoor	C1R		3BR1224N125R <sup>⑤⑥⑦⑧</sup>
200	30	42	Indoor	L1		3BR3042N200
225	42	42	Indoor	L2		3BR4242N225
	42	42	Indoor	B		3BR4242B225NY <sup>⑨</sup>

#### Notes

- ① The maximum rating of the loadcenter is the main circuit breaker rating when used as service entrance equipment.
- ② 100, 125 and 200 A convertible base unit catalog numbers include interior, box and cover only. Main devices and accessories must be ordered separately for field installation.  
All convertible base units are listed as suitable for use as service entrance equipment when used per Article 384 of the NEC.
- ③ Ground bar kits priced separately. See **Page V1-T1-71**.
- ④ For main breaker, use Type BR. For main lug, use Type BRSF.
- ⑤ BREQS125 hold-down screw comes with loadcenter for back-fed Types BR and BRH main circuit breakers.
- ⑥ Rainproof loadcenters are furnished with hub closure plates. For rainproof hubs, refer to **Page V1-T1-71**.
- ⑦ Convertible to maximum of 100 A main circuit breaker and 125 A main lug.
- ⑧ Suitable for use as service equipment when not more than six main disconnecting means are provided and when not used as a lighting and appliance panelboard.
- ⑨ Order 3BR42FTNY or 3BR42STNY cover separately.

Box sizes **Pages V1-T1-76 through V1-T1-79**.

**BR Plug-On Neutral Loadcenters**



### Contents

<b>Description</b>	<b>Page</b>
Overview .....	<b>V1-T1-42</b>
BR Specialty Products	
BR Plug-On Neutral Loadcenters	
Catalog Number Selection .....	<b>V1-T1-58</b>
Product Selection .....	<b>V1-T1-59</b>
BR Quick Connect Neutral Loadcenters .....	<b>V1-T1-60</b>
Spa Panels .....	<b>V1-T1-61</b>
Riser Panel .....	<b>V1-T1-62</b>
Type BR Renovation Loadcenter .....	<b>V1-T1-63</b>
BR Loadcenter Options and Accessories .....	<b>V1-T1-66</b>
BR Circuit Breakers .....	<b>V1-T1-80</b>

## BR Specialty Products

### BR Plug-On Neutral Loadcenters

#### Product Description

Quicker, easier and cleaner than the competition. Introducing the BR Plug-On Neutral portfolio from Eaton. Eaton's latest development in loadcenters and breakers has been redesigned to improve safety and ease of installation time, while offering a more professional look and feel.

#### Features and Benefits

- Redesigned the BR electronic breakers into a short-body to optimize gutter space and save time with an easier, more succinct installation process
- Unique self-leveling tabs to allow for quick drywall offset
- Added keyhole hanging feature on cover for ease of installation
- Common drive types on screw connections for added simplicity and convenience
- Inboard neutral to increase the gutter space for easier installation of conductors
- Backed-out neutral screws to allow for a quick connection of ground and neutral conductors
- Upgraded to embossed circuit numbers for a more clean and professional look

# 1.2

## Loadcenters and Circuit Breakers

### Type BR Loadcenters and Circuit Breakers

1

#### Catalog Number Selection

#### BR Plug-On Neutral Loadcenters

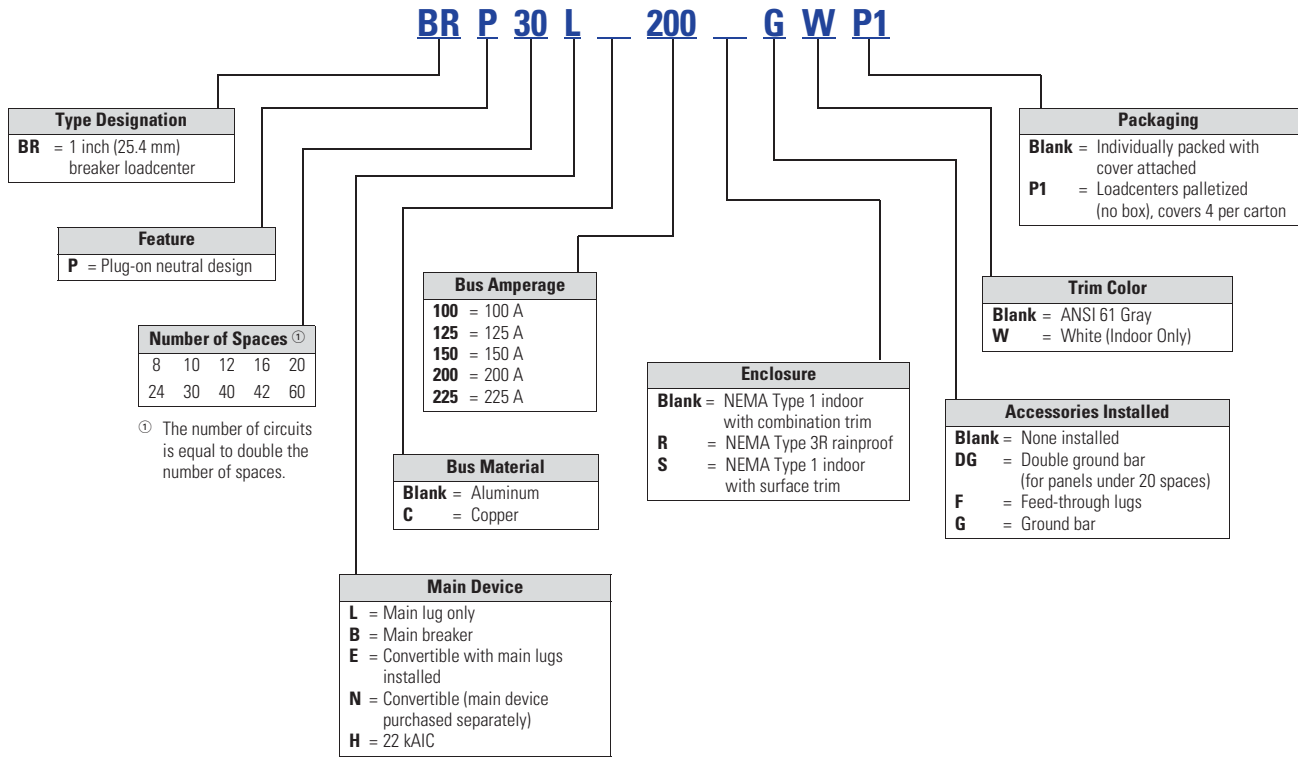

#### BR Electronic Circuit Breakers

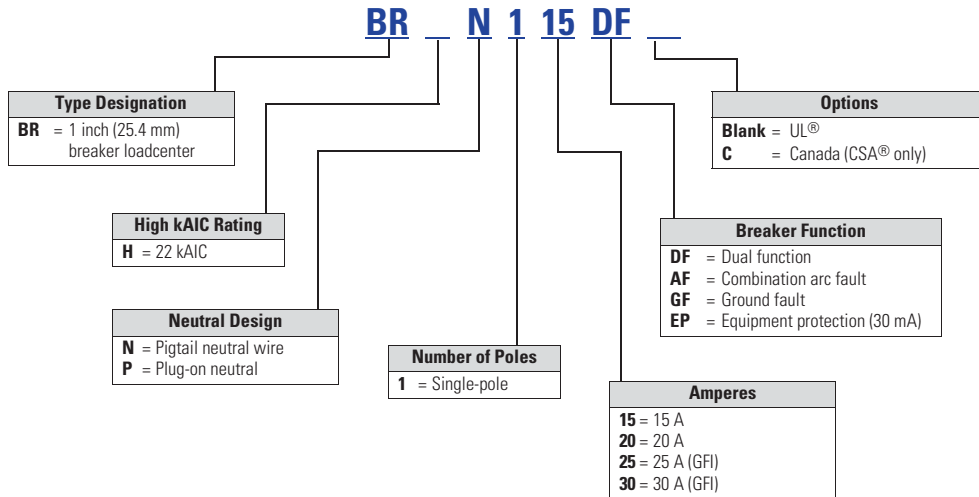

### Product Selection

BRP\_

#### BR Plug-On Neutral (PON) Loadcenters



Main Breaker Type	Main Ampere Rating	Spaces	Circuits	Enclosure Type	Box Size	Wire Size Range Cu/Al 60°C or 75°C for Main Breaker	Loadcenter Catalog Number with Combination or NEMA Type 3R Cover
CSR at 25 kAIC	200	30	60	Indoor	X6	#2–300 kcmil	<b>BRP30B200</b>
CSR at 25 kAIC	200	40	80	Indoor	X8	#2–300 kcmil	<b>BRP40B200</b>
—	200	30	60	Indoor	X5	#1–300 kcmil	<b>BRP30L200G</b>
—	200	40	80	Indoor	X8	①	<b>BRP40N200</b>

#### BR Electronic Breakers

Breaker Type	Plug-On Neutral Catalog Number	Pigtail Catalog Number	Ampere Rating	Poles	Wire Size	Breaker Type	LED Diagnostics Included
BR AFCI Breakers	<b>BRP115AF</b>	<b>BRN115AF</b>	15	Single-pole, 10 kAIC	#14–4	Combination AFCI	Yes
	<b>BRP120AF</b>	<b>BRN120AF</b>	20	Single-pole, 10 kAIC	#14–4	Combination AFCI	Yes
BR GFCI Breakers	<b>BRP115GF</b>	<b>BRN115GF</b>	15	Single-pole, 10 kAIC	#14–4	Personnel Protection GFCI	Yes
	<b>BRP120GF</b>	<b>BRN120GF</b>	20	Single-pole, 10 kAIC	#14–4	Personnel Protection GFCI	Yes
BR Dual Function Breakers	<b>BRP115DF</b>	<b>BRN115DF</b>	15	Single-pole, 10 kAIC	#14–4	Dual Function AFCI/GFCI	Yes
	<b>BRP120DF</b>	<b>BRN120DF</b>	20	Single-pole, 10 kAIC	#14–4	Dual Function AFCI/GFCI	Yes
BR 22 kAIC AFCI Breakers	—	<b>BRHN115AF</b>	15	Single-pole, 10 kAIC	#14–4	Combination AFCI	Yes
	—	<b>BRHN120AF</b>	20	Single-pole, 10 kAIC	#14–4	Combination AFCI	Yes
BR GFCI Breakers	—	<b>BRHN115GF</b>	15	Single-pole, 10 kAIC	#14–4	Personnel Protection GFCI	Yes
	—	<b>BRHN120GF</b>	20	Single-pole, 10 kAIC	#14–4	Personnel Protection GFCI	Yes
	—	<b>BRHN125GF</b>	25	Single-pole, 10 kAIC	#14–4	Personnel Protection GFCI	Yes
	—	<b>BRHN130GF</b>	30	Single-pole, 10 kAIC	#14–4	Personnel Protection GFCI	Yes
BR 30 mA GFCI Breakers	—	<b>BRN115EP</b>	15	Single-pole, 10 kAIC	#14–4	Equipment Protection	Yes
	—	<b>BRN120EP</b>	20	Single-pole, 10 kAIC	#14–4	Equipment Protection	Yes
	—	<b>BRN125EP</b>	25	Single-pole, 10 kAIC	#14–4	Equipment Protection	Yes
	—	<b>BRN130EP</b>	30	Single-pole, 10 kAIC	#14–4	Equipment Protection	Yes
BR 22 kAIC Dual Function Breakers	—	<b>BRHAFGF115</b>	15	Single-pole, 10 kAIC	#14–4	Dual Function AFCI/GFCI	Yes
	—	<b>BRHAFGF120</b>	20	Single-pole, 10 kAIC	#14–4	Dual Function AFCI/GFCI	Yes

**Note**

① See Main Breaker and Main Lug Kit tables, **Page V1-T1-52**.

#### BR Quick Connect Neutral Loadcenters



### BR Quick Connect Neutral Loadcenters

#### Product Description

The Type BR Quick Connect Neutral loadcenters coupled with Type BR Quick Connect Neutral electronic breakers provide a clean, quick connection for an installer looking to save time while providing a professional look.

#### Features and Benefits

- Full-length neutral bars provide over 300% neutral capacity while enhancing installation flexibility for the installer
- Backed-out neutral screws allow an installer to make a quick connection when terminating neutral and ground wires
- Extended circuits (30/60, 40/80) provide maximum flexibility to a contractor on every space possible
- Standard LED diagnostics on AFCI and AF/GF breakers provides installers best-in-class troubleshooting technology
- Cut-to-length neutral wires provides a clean, professional look versus traditional pigtail circuit breakers
- Solid-tip, stranded neutral wires provide a quick connection to the full length neutral bar

### Contents

<i>Description</i>	<i>Page</i>
Overview . . . . .	V1-T1-42
BR Specialty Products	
BR Plug-On Neutral Loadcenters . . . . .	V1-T1-57
BR Quick Connect Neutral Loadcenters	
Spa Panels . . . . .	V1-T1-61
Riser Panel . . . . .	V1-T1-62
Type BR Renovation Loadcenter . . . . .	V1-T1-63
BR Loadcenter Options and Accessories . . . . .	V1-T1-66
BR Circuit Breakers . . . . .	V1-T1-80

### Product Selection

#### BR Quick Connect Neutral Loadcenters ①

Main Device	Ampere Rating	Spaces	Circuits ②	Incoming Lug Size	Enclosure Type ③	Box Size	Ground Bar	Number of Neutral Terminations	Catalog Number
BR 10 kAIC	100	30	60	#4-1/0	Indoor	D1	④	96	BR3060BQN100
CSR 25 kAIC	150	30	60	#2-300 kcmil	Indoor	G1	④	102	BR3060BQN150
CSR 25 kAIC	200	30	60	#2-300 kcmil	Outdoor	L1R	④	94	BR3060BQN200R
CSR 25 kAIC	200	40	80	#2-300 kcmil	Outdoor	G1R	④	128	BR4080BQN200R
Main lug only	125	24	48	#6-2/0	Indoor	C2	GBK14	80	BR2448LQN125G
Main lug only	125	30	60	#6-2/0	Indoor	D1	GBK10	96	BR3060LQN125G
Main lug only	200	30	60	#1-300 kcmil	Indoor	D1	GBK1020 + GBK10	96	BR3060LQN200G
Main lug only	200	40	80	#1-300 kcmil	Indoor	G1	GBK1020 + GBK10	122	BR4080LQN200G
Main lug only	125	20	40	#6-2/0	Outdoor	C1R	GBK14	68	BR2040LQN125RG
Main lug only	200	30	60	#1-300 kcmil	Outdoor	D1R	GBK1420	94	BR3060LQN200RG
Convertible	200	30	60	—	Indoor	G1	④	102	BR3060NQN200
Convertible	200	40	80	—	Indoor	L1	④	128	BR4080NQN200
Convertible	200	30	60	—	Outdoor	G1R	④	94	BR3060NQN200R
Convertible	200	40	80	—	Outdoor	L1R	④	128	BR4080NQN200R

#### BR Quick Connect Neutral Electronic Breakers

Ampere Rating	Poles	Wire Size	Breaker Type	LED Diagnostics Included	Catalog Number
15	Single-pole 10 kAIC	#14-4	Combination AFCI	Yes	BRCAF115QN
20	Single-pole 10 kAIC	#14-4	Combination AFCI	Yes	BRCAF120QN
15	Single-pole 10 kAIC	#14-4	Arc fault/ground fault	Yes	BRLAFGF115QN
20	Single-pole 10 kAIC	#14-4	Arc fault/ground fault	Yes	BRLAFGF120QN

#### Notes

- ① BR Quick Connect Neutral loadcenters accept both standard and Quick Connect Neutral breakers.
- ② Loadcenters accept Type BR twin breakers.
- ③ Combination cover included with every indoor loadcenter.
- ④ Ground bar kit not included. Purchase separately.

### Spa Panels



## Spa Panels

### Product Description

Eaton's BR Spa Panels distribute power to outdoor loads and provide protection for people from electric shock. Save time and money with streamlined installation procedures and easy-access features. Spa panels meet NEC requirements by providing a ground fault circuit interruption device and a disconnect switch in a single simple device. Ships assembled prewired, factory tested and ready to install.

### Features

- 10-year warranty
- UL Listed
- Factory-installed two-pole ground fault circuit interrupter (GFCI)

### Product Selection

#### BR Spa Panel



#### Spa Panel—Meets NEC Article 680.40 Through 680.43—Requirements for GFCI Protection

Main Ampere Rating	Maximum Number 1-Inch (25.4 mm)		Enclosure Type	Box Size	Wire Size Range Cu/Al 60 °C or 75 °C for Main Lugs	Catalog Number
	Space	Poles				
40	—	—	Outdoor	5R	#8-#2	BR40SPAST <sup>①</sup>
50	—	—	Outdoor	5R	#8-#2	BR50SPAST <sup>②</sup>

#### Notes

- ① Includes a GFTCB240 breaker, factory installed.
- ② Includes a GFTCB250 breaker, factory installed.

## Contents

### Description

	Page
Overview	V1-T1-42
BR Specialty Products	
BR Plug-On Neutral Loadcenters	V1-T1-57
BR Quick Connect Neutral Loadcenters	V1-T1-60
Spa Panels	
Riser Panel	V1-T1-62
Type BR Renovation Loadcenter	V1-T1-63
BR Loadcenter Options and Accessories	V1-T1-66
BR Circuit Breakers	V1-T1-80

#### Riser Panel



#### Contents

<i>Description</i>	<i>Page</i>
Overview . . . . .	V1-T1-42
BR Specialty Products	
BR Plug-On Neutral Loadcenters . . . . .	V1-T1-57
BR Quick Connect Neutral Loadcenters . . . . .	V1-T1-60
Spa Panels . . . . .	V1-T1-61
Riser Panel	
Type BR Renovation Loadcenter . . . . .	V1-T1-63
BR Loadcenter Options and Accessories . . . . .	V1-T1-66
BR Circuit Breakers . . . . .	V1-T1-80

### Riser Panel

#### Product Description

Eaton's Riser Panel is a loadcenter with an offset interior to allow riser cables to pass through the enlarged gutter. By using lay-in tap lugs, the contractor is able to simply strip off a length of the riser cable's insulation, and tap off to the riser panel's main lugs. These panels are used in the construction of assisted living homes, dormitories, public housing complexes and apartments.

#### Product Selection

##### BR1224L125RIS



#### Riser Panel

Main Ampere Rating	Maximum Number 1-Inch (25.4 mm)		Enclosure Type	Box Size	Wire Size Range Cu/Al 60 °C or 75 °C for Main Lugs	Catalog Number
	Space	Circuits				
125	12	24	Indoor	C4	#6-2/0	<b>BR1224L125RIS</b>
125	12	24	Indoor	C4	#6-2/0	<b>BR1224L125RISBP</b> ①
125	20	24	Indoor	C4	#6-2/0	<b>BR2024L125RIS</b>
125	20	24	Indoor	C4	#6-2/0	<b>BR2024L125RISBP</b> ①
125	20	30	Indoor	C2	#6-2/0	<b>BR2030L125RIS</b>
200	30	40	Indoor	D1	#1-300	<b>BR3040L200RIS</b>

##### BRGUTTER (Shown with Loadcenter)



#### Riser Panel Accessories

##### Catalog Number

**BRGUTTER** ②  
**GTAP250**

#### Notes

- ① Bulk-packaged loadcenter without carton. Must be ordered in multiples of 16.
- ② Refer to **Page V1-T1-77** for dimensions. BRGUTTER is box size C2.

#### Accessories

For riser panels not shown, contact the Flex Center at 1-800-330-6479 for both CH and BR riser panels.

### BR Renovation Loadcenters

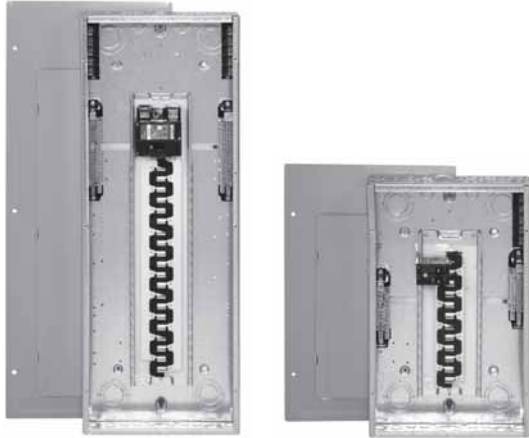

### Contents

Description	Page
Overview	V1-T1-42
BR Specialty Products	
BR Plug-On Neutral Loadcenters	V1-T1-57
BR Quick Connect Neutral Loadcenters	V1-T1-60
Spa Panels	V1-T1-61
Riser Panel	V1-T1-62
Type BR Renovation Loadcenter	
BR Loadcenter Options and Accessories	V1-T1-66
BR Circuit Breakers	V1-T1-80

## Type BR Renovation Loadcenter

### Product Description

- Available in 10, 20, 30 and 40 circuit main breaker styles
- Designed to replace existing loadcenters and fuse boxes
- Type BR loadcenter packaged with circuit breakers
- Factory-installed 5-circuit terminal block(s)
- Twin-stacked neutral design

### Features, Benefits and Functions

- Factory-installed terminal block(s) allows installer to terminate existing short wires without using wire nuts or junction boxes
- Twin-stacked neutrals are mounted up high in the loadcenter, which allows for all neutral and ground wires to be terminated in the top half of the loadcenter
- Specifically designed for the service contractor—this is the ONLY renovation line in the industry
- Single-pole and two-pole breakers included
- 10-year warranty on loadcenter and breakers

## Product Selection

### BR2020B100RN



### BR Value Packs ①

Main Breaker Type	Description	Wire Size Range	Number of 5-Circuit Terminal Blocks	Single-Pole Breakers	Two-Pole Breakers	Catalog Number
BR 10 kAIC	Single-phase 100 A 10k main breaker 10/20 circuit surface-mount box is 11.75" wide x 13" tall	#6-1/0	0	(2) BR115	(1) BR230	BR1020B100SRNV
	Single-phase 100 A 10k main breaker 10/20 circuit flush-mount box is 11.75" wide x 13" tall		0	(2) BR115	(1) BR230	BR1020B100FRNV

### Note

① Indoor enclosure type.



#### Type BR Retrofit Interior



**Type BR Retrofit Adjustable Interior**



**Type BR Retrofit Interior Collar and Assembly with Trim**

### Contents

<b>Description</b>	<b>Page</b>
Overview .....	<b>V1-T1-42</b>
BR Specialty Products	
BR Plug-On Neutral Loadcenters .....	<b>V1-T1-57</b>
BR Quick Connect Neutral Loadcenters .....	<b>V1-T1-60</b>
Spa Panels .....	<b>V1-T1-61</b>
Riser Panel .....	<b>V1-T1-62</b>
Type BR Renovation Loadcenter .....	<b>V1-T1-63</b>
BR Loadcenter Options and Accessories	
Type BR Retrofit Interior Kits	
BR Specialty Product Selection .....	<b>V1-T1-65</b>
Type BR Mechanical Interlock Kits .....	<b>V1-T1-68</b>
Technical Data and Specifications .....	<b>V1-T1-73</b>
Dimensions .....	<b>V1-T1-76</b>
BR Circuit Breakers .....	<b>V1-T1-80</b>

### Type BR Retrofit Interior Kits

#### Product Description

Eaton's unique Retrofit Interior allows the customer to cost-effectively and safely upgrade an electrical service without removing the existing enclosure from the wall.

#### Application Description

The Retrofit Interior is designed and tested specifically for renovating an outdated electrical panel in an apartment, a condominium or a single family home. These outdated panels are being recognized by local inspectors and other authorities as a possible hazard.

#### Opportunities to Retrofit

- Single- or three-phase
- Main lug only or main breaker
- Up to 42 circuits
- Up to 225 A interiors, 400 A available upon request
- Available with CH breakers (3/4-inch) with copper bus or BR breakers (1-inch) with aluminum bus
- The minimum lifetime warranty for residential breakers shall be as follows:
  - 10-year warranty on all BR branch breakers and loadcenters
  - Refer to Eaton for complete warranty details

#### Features and Benefits

##### **Upgrading Existing Electrical Infrastructure Is Simple**

- Replaces vintage brands that have hard to find, expensive replacement breakers
- Safety upgrade to arc fault and ground fault breakers to meet current electrical codes
- Maximizes number of circuits available with compact design
- Eco-friendly in asbestos-filled environments
- Exclusive design

##### **Save Time and Money Throughout the Installation**

- Uses existing panel box and wires
- Eliminates expensive and time-consuming drywall/paint repair
- Saves 2–3 hours of installation time compared to a complete panel changeout
- Eliminates precise measurements with field-adjustable kit

#### Standards and Certifications

- Meets 2017 NEC wire bending requirements
- UL 67 Listed (for UL listings for specific part numbers, see the table on the following page.



### BR Specialty Product Selection

To select the retrofit kit:

1. From the existing box size determine which retrofit groups are suitable (may be more than one).
2. Use type of interior, number of phases, and type of main to find the selection chart.
3. Select part number from chart (if main breaker, replace XXX with specific amp rating).

#### How to Order:

1. Measure the existing panel enclosure to determine appropriate kits for your project.
2. Match the existing dimensions with the table below to obtain the correct catalog number.
3. Order your retrofit kit from a local Eaton authorized distributor.

Need assistance or can't find retrofit to fit existing enclosure?

Call Eaton's Residential Flex Center at 1-800-330-6479 or email for all your retrofit needs. Go to [www.eaton.com/eccn](http://www.eaton.com/eccn) to locate an Eaton Certified Contractor.

### Retrofit Interior Kit Specifications

Five recommended groups: existing box height determines retro group size. Approximate Dimensions in Inches (mm).

Catalog Number ①	Cover ②	Existing Enclosure Parameters—Inches (mm)				Phase	Main	Bus	Amperes ③	Spaces / Circuits	UL 67 Listed
		Minimum Depth	Maximum Depth	Minimum Width	Minimum Height						
<b>BR Retrofit Interiors and Covers</b>											
RTBR8L100P	CRTBR8ML****	3.13 (79.5)	3.63 (92.2)	10.50 (266.7)	13.00 (330.2)	Single	MLO	BR	100	8/16	Yes
RUBR8L100_	CRUBR8ML****	3.75 (95.3)	6.00 (152.4)	10.50 (266.7)	13.00 (330.2)	Single	MLO	BR	100	8/16	Yes
RTBR12L100P	CRTBR12ML****	3.13 (79.5)	3.63 (92.2)	10.50 (266.7)	14.50 (368.3)	Single	MLO	BR	100	12/24	Yes
RTBR10B100P	CRTBR12ML****	3.13 (79.5)	3.63 (92.2)	10.50 (266.7)	14.50 (368.3)	Single	MLO	BR	100	10/20	Yes
RUBR12L100_	CRUBR12ML****	3.75 (95.3)	6.00 (152.4)	10.50 (266.7)	14.50 (368.3)	Single	MLO	BR	100	12/24	Yes
RUBR10B100_	CRUBR12ML****	3.75 (95.3)	6.00 (152.4)	10.50 (266.7)	14.50 (368.3)	Single	MB	BR	100	10/20	Yes
RTBR12L125P	CRTBR12ML****	3.13 (79.5)	3.63 (92.2)	11.00 (279.4)	17.00 (431.8)	Single	MLO	BR	125	12/24	Yes
RTBR10B125P	CRTBR12ML****	3.13 (79.5)	3.63 (92.2)	11.00 (279.4)	17.00 (431.8)	Single	MB	BR	125	10/20	Yes
RUBR12L125_	CRUBR12ML****	3.75 (95.3)	6.00 (152.4)	11.00 (279.4)	17.00 (431.8)	Single	MLO	BR	125	12/24	Yes
RUBR10B125_	CRUBR12ML****	3.75 (95.3)	6.00 (152.4)	11.00 (279.4)	17.00 (431.8)	Single	MB	BR	125	10/20	Yes
RABR20B125_	CRABR20ML****	3.75 (95.3)	6.00 (152.4)	13.00 (330.2)	21.00 (533.4)	Single	MCB	BR	125	20/24	No
RABR20L125_	CRABR20ML****	3.75 (95.3)	6.00 (152.4)	13.00 (330.2)	21.00 (533.4)	Single	MLO	BR	125	20/24	No
RBBR20B200_	CRBBR20BW****	3.75 (95.3)	6.00 (152.4)	13.00 (330.2)	29.00 (736.6)	Single	MLO	BR	200	20/40	No
RBBR20L200_	CRBBR20BW****	3.75 (95.3)	6.00 (152.4)	13.00 (330.2)	29.00 (736.6)	Single	MLO	BR	200	20/40	No
RBBR40L200_	CRBBR40ML****	3.75 (95.3)	6.00 (152.4)	13.00 (330.2)	34.00 (863.6)	Single	MLO	BR	200	30/40	No
RDBR40B200_	CRDBR40BW****	3.75 (95.3)	6.00 (152.4)	13.00 (330.2)	37.00 (939.8)	Single	MLO	BR	200	40/40	No

#### Complete Assembly

**Note:** For complete assembly, interior and cover need to be ordered separately.

#### Adjustable Interior

- Factory installed ground and neutral bars positioned to accept existing wires
- Field adjustable depth matches existing panel box
- Adjustable height enables optional placement of the interior
- Field bondable for service entrance options



Adjustable Interior

#### Standard Trim and Collar

- Standard trim matches new interior
- New circuit directory for updated labeling
- Oversized collar eliminates expensive wall/paint repair



Collar and Assembly with Trim

#### Notes

- ① Catalog numbers shown with "\_" at the end need one of the following suffixes to denote depth:  
J = 3.75–4.25  
K = 4.25–5.00  
L = 5.00–6.00  
Example: RUBR12L125J would signify an interior set with a depth range of 3.75 to 4.25 inches.
- ② \*\*\*\* Denotes characters in the catalog number that relate to overall cover size. Example: CRTBR12ML2620 would signify a cover 26.00 inches H x 20.00 inches W.
- ③ Amperes for MB panels is maximum; catalog number will reflect actual amperage of breaker included.

For UL applications, maximum cover sizes may apply.

Options and Accessories—Mechanical Interlocks



### Contents

<i>Description</i>	<i>Page</i>
Overview . . . . .	V1-T1-42
BR Specialty Products	
BR Plug-On Neutral Loadcenters . . . . .	V1-T1-57
BR Quick Connect Neutral Loadcenters . . . . .	V1-T1-60
Spa Panels . . . . .	V1-T1-61
Riser Panel . . . . .	V1-T1-62
Type BR Renovation Loadcenter . . . . .	V1-T1-63
BR Loadcenter Options and Accessories	
Type BR Retrofit Interior Kits . . . . .	V1-T1-64
Type BR Mechanical Interlock Kits . . . . .	V1-T1-68
Technical Data and Specifications . . . . .	V1-T1-73
Dimensions . . . . .	V1-T1-76
BR Circuit Breakers . . . . .	V1-T1-80

## BR Loadcenter Options and Accessories

### Product Selection

**BRSF125**



**3BRS225**



**BRL200**



**TDL**



### Field Installation Kits and Parts

Number of Poles	Ampere Rating	Number of 1-Inch (25.4 mm) Spaces Needed	Wire Size Range Cu/Al 60 °C or 75 °C	Ordering Quantity ①	Catalog Number
<b>Main and Sub-Feed Lug Blocks</b>					
2	125	2	#8–2/0	1	<b>BRSF125</b>
	150	2	#8–2/0	1	<b>BRSF150</b> ②
	225	4	#2–300 kcmil	1	<b>BRS225</b>
3	150	3	#8–2/0	1	<b>3BRSF150</b> ②
	225	6	#2–300 kcmil	1	<b>3BRS225</b>
<b>Main Lugs</b>					
Two-pole, 200 A stud mounted (includes deadfront filler plate)			#1–300 kcmil	1	<b>BRL200</b>
Neutral/ground lug			#2/0 maximum	1	<b>NL20</b>
Add-on neutral or ground lug			#3/0 maximum	1	<b>NL30</b>
			300 kcmil maximum	1	<b>NL300</b>
<b>Filler Plates</b>					
1-inch (25.4 mm) circuit breaker space				25	<b>BRFP</b>
BW main circuit breaker space (with hardware)				1	<b>BWFP</b>
Door lock—12–42 circuits, and 100–225 A				1	<b>TDL</b>
Door lock—4–8 circuits, 125 A				1	<b>CH9FL</b>
ANSI-61 light gray touchup paint for current loadcenters				1	<b>SPC61</b>
Isolated neutral assembly (computer circuits)				1	<b>BINA</b>
Circuit directory—adhesive backed				10	<b>TCD</b>
Cover screws				25	<b>LCCS</b>
Cover replacement latch (gray) 14-5/16 (363.5 mm) wide loadcenters only				1	<b>BRRL</b>
Circuit marking strip (next to breaker)				10	<b>BRMS</b>
Circuit identification label (preprinted breaker labels)				25	<b>CHBL</b>
Series rated caution label				25	<b>SRL</b>
Bonding strip with screw				1	<b>BSSUSE</b>

**Notes**

- ① Must be purchased in multiples of ordering quantities indicated.
- ② #8–2/0 wire size range is 75 °C rated only.

**Three-Phase Accessories****Three-Phase Main Breaker Kits— 10 kAIC**

<b>Ampere Rating</b>	<b>Wire Size Range Cu/Al 60 °C or 75 °C</b>	<b>Catalog Number</b>
100	#6–4/0	<b>CC3100N</b>
125	#6–4/0	<b>CC3125N</b>
150	#6–4/0	<b>CC3150N</b>
175	#2/0–300 kcmil	<b>CC3175N</b>
200	#2/0–300 kcmil	<b>CC3200N</b>
225	#2/0–300 kcmil	<b>CC3225N</b>

**Three-Phase Main Lugs Kit for Convertible Loadcenters**

<b>Ampere Rating</b>	<b>Wire Size Range Cu/Al 60 °C or 75 °C</b>	<b>Catalog Number</b>
225	#1–300 kcmil	<b>3BRL225</b>
225	#1–300 kcmil	<b>3BRS225</b> ①

**Note**

① For subfeed.

Box sizes **Pages V1-T1-76** through **V1-T1-79**.

#### Type BR Mechanical Interlock Kits



**Type BR Loadcenter with Mechanical Interlock Kit**

### Type BR Mechanical Interlock Kits

#### Product Description

With the aging electrical infrastructure and frequent severe storms, power outages are becoming more and more frequent, affecting thousands of people nationwide. Eaton mechanical interlock kit provides an easy and cost-effective solution when using backup emergency power.

This solution expands the robust line of emergency power products and accessories.

#### Features and Benefits

- Prevents utility and generator supplies from being on at the same time
- Protects utility linemen from dangerous generator backfeed
- Robust interlock design
- Offered in two unique styles for almost any BR loadcenter, which can reduce inventory levels
- Quick and easy installation—drill points or fixtures for pilot holes are provided on all applicable BR loadcenters; no additional assembly is required

### Contents

#### Description

	<i>Page</i>
Overview	V1-T1-42
BR Specialty Products	
BR Plug-On Neutral Loadcenters	V1-T1-57
BR Quick Connect Neutral Loadcenters	V1-T1-60
Spa Panels	V1-T1-61
Riser Panel	V1-T1-62
Type BR Renovation Loadcenter	V1-T1-63
BR Loadcenter Options and Accessories	
Type BR Retrofit Interior Kits	V1-T1-64
Type BR Mechanical Interlock Kits	V1-T1-68
Technical Data and Specifications	V1-T1-73
Dimensions	V1-T1-76
BR Circuit Breakers	V1-T1-80

#### Standards and Certifications

- UL 67 Listed—For use with BR loadcenters
- Meets NEC® Article 702



#### Product Selection



Each mechanical interlock kit includes:

- Interlock assembly
- Hold down kit ①
- New labels
- Necessary screws

Warranty information:

- 10-year warranty on all Type BR circuit breakers and loadcenters
- Refer to Eaton for complete warranty details

#### Mechanical Interlock Kits ②

	Description	Catalog Number
	Single	<b>BRMIKBR</b>
	Bulk pack ③	<b>BRMIKBRBP</b>
	Single	<b>BRMIKCSR</b>
	Bulk pack ③	<b>BRMIKCSRBP</b>

#### Notes

- ① For breakers under 70 A used in backfed applications, add “B” to the end of the catalog string to get the appropriate “hold-down” version.
- ② Clamshell packaged.
- ③ Bulk pack contains 10 units, individually packaged.

### Mechanical Interlock Cover

Covers mechanically interlock two breakers—Type BW or CSR main breaker with a Type BR branch breaker.

BR816B100



### Mechanical Interlock Cover

Fits Loadcenter Catalog Numbers	Mechanical Interlock Trim/Deadfront Catalog Numbers	Mechanical Interlock Kit Catalog Numbers
<b>Indoor</b>		
BR816B100	BRCOVC10M	BRMIKBR
BR816N100		
BR1212B100	BRCOVC12M	
BR1220B100		
BR1220H100		
BR1224N125	BRCOVC13M	
BR1616B100	BRCOVC16M	
BR1620B100		
BR1624B100		
BR1624B125	BRCOVC17M	
BR1624N125		
BR2020B100, BR2020BC100 BR2020H100, BR2020HC100	BRCOVC22M	
BR2024H100		
BR2020HC100		
BR2030B100		
BR2040B100		
BR2024B125	BRCOVC23M	
BR2024N125, BR2024NC125		
BR3030B100, BR3030BC100	BRCOVC59M	
BR3030H100, BR3030HC100		
<b>Raintight</b>		
BR1020B100R	BR3RDF1M	Field-installed interlock kits not available for these catalog numbers.
BR1224B100R		
BR1224N125R, BR1224NC125R		
BR1624B100R	BR3RDF2M	
BR1624N125R		
BR2024B100R, BR2024B125R	BR3RDF4M	
BR2024N125R, BR2024NC125R		

BR4040B200



## Mechanical Interlock Cover, continued

Fits Loadcenter Catalog Numbers	Mechanical Interlock Trim/Deadfront Catalog Numbers	Mechanical Interlock Kit Catalog Numbers
<b>Indoor</b>		
BR1630B150	BRCOV16C4FM	BRMIKCSR
BR1224N200		
BR1632B200		
BR1632N200		
BR2030B150	BRCOV20C4FM	
BR2030H150		
BR2040B150		
BR2040B200, BR2040BC200	BRCOV20D1FM	
BR2040H200		
BR2040N200, BR2040NC200		
BR2430B150, BR2430BC150	BRCOV30G1FM	
BR3030B150		
BR3030H150		
BR3040B150		
BR2440B200		
BR2440N200		
BR3040BC200		
BR3040N200, BR3040NC200		
BR4040BC200	BRCOV40L1FM	
BR4040N200, BR4040NC200		
BR4242B225	BRCOV42L2FM	
<b>Raintight</b>		
BR816B150RF	BR3RDF5M ①	
BR816B200RF		
BR816N200RF		
BR1224N200R		
BR2030B150R	BR3RDF11M ①	
BR2040B150R		
BR2040B200R		
BR2040B225R		
BR2040N200R		
BR3030B150R	BR3RDF12M ①	
BR3040B200R		
BR3040N200R		
BR4040B200R	BR3RDF13M ①	
BR4040N200R		
BR48B200RF	BR3RDF14M	
BR4242B225R	BR3RDF15M ①	
<b>Mechanical Interlock Loadcenter Replacement Covers ②</b>		
BR2020B100M, BR2020BC100M	BRCOV20C2FM	Field-installed interlock kits not available for these catalog numbers.
BR2024H100M		
BR3030BC100M	BRCOV30D1FM	

**Notes**

① Deadfront only.

② Can only be provided as replacement covers for factory-installed mechanically interlock loadcenters.

### DS300H2



### Field Installation Rainproof Conduit Hubs

#### Description

Group 1—for use with 70, 100 and 125 A MLO and MCB loadcenters and circuit breaker enclosures and the following 150 and 200 A panels: BR48B200RF

Group 2—for use with 150, 200 and 225 A MLO and MCB loadcenters and circuit breaker enclosures except for the following 200 A loadcenters: BR48B200RF. Also for use with 400 and 600 A loadcenters and New York City loadcenters manufactured after November 1, 2005

Type H conduit hubs for loadcenters PL0724R and S3100RN

Adapter kit—Allows installing a Group 1 hub on devices arranged for Group 2 hubs

Group 1 small blank hub plate with bump

Group 2 Large blank hub plate with bump

Conduit Size Inches (mm)	Ordering Quantity <sup>①</sup>	Catalog Number
0.75 (19.1)	1	<b>DS075H1</b>
1.00 (25.4)	1	<b>DS100H1</b>
1.25 (31.8)	1	<b>DS125H1</b>
1.50 (38.1)	1	<b>DS150H1</b>
2.00 (50.8)	1	<b>DS200H1</b>
2.00 (50.8)	1	<b>DS200H2</b>
2.50 (63.5)	1	<b>DS250H2</b>
3.00 (76.2)	1	<b>DS300H2</b>
0.75 (19.1)	1	<b>RH75P</b>
1.00 (25.4)	1	<b>RH100P</b>
1.25 (31.8)	1	<b>RH125P</b>
1.50 (38.1)	1	<b>RH150P</b>
—	1	<b>DS900AP</b>
—	1	<b>DS900CP1</b>
—	1	<b>DS900CP2</b>

### GBK14



### BRGBK39512



### Ground Bar Kits

Description (See Legend)	Length Inches (mm)	Ordering Quantity <sup>①</sup>	Catalog Number
●○○○○●○	2.54 (64.5)	1	<b>GBK5</b> <sup>②</sup>
●○○○○●■	3.59 (91.2)	1	<b>GBK520</b> <sup>②</sup>
●○○○○●○○○○○	4.29 (109.0)	1	<b>GBK10</b> <sup>②</sup>
●○○○○●○○○○○■	5.34 (135.6)	1	<b>GBK1020</b> <sup>②</sup>
— — — — —	4.61 (117.1)	1	<b>GBK13</b> <sup>②</sup>
●○○○○●○○○○○○○○○○	5.69 (144.5)	1	<b>GBK14</b> <sup>②</sup>
●○○○○●○○○○○○○○○○■	6.74 (171.2)	1	<b>GBK1420</b> <sup>②</sup>
●○○○○●○○○○○○○○○○○○○○○○	8.14 (206.8)	1	<b>GBK21</b> <sup>②</sup>
●○○○○●○○○○○○○○○○○○○○○○■	9.19 (233.4)	1	<b>GBK2120</b> <sup>②</sup>
⌞ — ⌞ ⌞ — ⌞ ⌞ — ⌞	5.78 (146.8)	1	<b>BRGBK39512</b> <sup>③④</sup>
○○○○○	1.84 (46.7)	1	<b>GB4NM</b> <sup>⑤</sup>

#### Ground Bar Legend

- (3) #14–10 Cu/Al or (1) #14–4 Cu/Al
- (1) #6–2/0 Cu/Al
- ⌞ (1) #14–1/0 Cu/Al or (3) #14–10 Cu/Al
- ⌞ (1) #14–6 Cu/Al or (2) #14–12 Cu/Al
- Mounting Hole

#### Notes

- <sup>①</sup> Must be purchased in multiples of ordering quantities indicated.
- <sup>②</sup> Distance between mounting holes is 1.75 inches (44.5 mm).
- <sup>③</sup> For single- and three-phase 400 and 600 A applications.
- <sup>④</sup> Distance between mounting holes is 2.34 inches (59.5 mm).
- <sup>⑤</sup> For non-metallic enclosures. Snaps into molded base.



# 1.2

## Loadcenters and Circuit Breakers

### Type BR Loadcenters and Circuit Breakers

1

#### Loadcenter Goof Collars

Don't let an ugly drywall problem ruin a beautiful electrical installation.

Eaton's Goof Collar is designed to cover gaps between the finished drywall and loadcenter enclosure.

This is often necessary when upgrading the electrical service and the drywall surrounding the panel is damaged. The collar allows 2 inches of overhang beyond the standard flush trim.



Before



After

#### BR Goof Collars

Inches (mm)		Catalog Number	
Height	Width	BR Box Size	Goof Collar
21.00 (533.4)	19.00 (482.6)	<b>B1</b>	<b>BRB1GC2119</b>
23.00 (584.2)	19.00 (482.6)	<b>B2</b>	<b>BRB2GC2319</b>
25.00 (635.0)	19.00 (482.6)	<b>C1</b>	<b>BRC1GC2519</b>
27.00 (685.8)	19.00 (482.6)	<b>C2</b>	<b>BRC2GC2719</b>
31.00 (787.4)	19.00 (482.6)	<b>C4</b>	<b>BRC4GC3119</b>
34.00 (863.6)	19.00 (482.6)	<b>D1</b>	<b>BRD1GC3419</b>
38.00 (965.2)	19.00 (482.6)	<b>G1</b>	<b>BRG1GC3819</b>
43.00 (1092.2)	19.00 (482.6)	<b>L1</b>	<b>BRL1G4319</b>
48.00 (1219.2)	19.00 (482.6)	<b>L2</b>	<b>BRL2GC4819</b>

#### Note

Type BD Duplex, BQ and BQC Quadplex circuit breakers can be installed in Circuit Limiting (CTL) listed BR loadcenters. Type BR twin breakers can be installed in Non-CTL BR loadcenters.

**Technical Data and Specifications****General**

- A. The Contractor shall furnish and install deadfront loadcenters incorporating circuit breakers of the number, rating and type as specified herein and as shown on the contract drawings.
- B. The loadcenter and all components shall be designed, manufactured and tested in accordance with the latest applicable standards of UL, NEMA and NEC including:
  - 1. UL 67—Standards for Panelboards.
  - C. UL 50—Standards for Cabinets and Boxes.
  - D. UL 489—Standards for Molded Case Circuit Breakers.
  - E. UL 869—Standards for Service Equipment.
  - F. Federal Specification W-C 375B—Circuit Breakers.
  - G. Federal Specification W-C P115b—Panel Power Distribution Type 1, Class 2.

**Qualifications**

- A. The manufacturer of the loadcenter shall be the manufacturer of the circuit breaker within the loadcenter.
- B. For the equipment specified herein, the manufacturer shall be ISO 9000 certified.
- C. The manufacturer of this equipment shall have produced similar electrical equipment for a minimum period of seven (7) years.

**Manufacturers**

- A. Eaton.

**Ratings**

- A. Loadcenters shall be rated for 120/240 Vac and shall have short-circuit ratings as shown on the drawings or as herein scheduled, but not less than 10,000 amperes rms symmetrical.
- B. Circuit breakers shall be a minimum of 125 A frame. Circuit breakers 15 through 125 A trip size shall take up the same pole spacing.
- C. Loadcenters shall be labeled with a UL short-circuit rating. When series combination ratings are applied with integral or remote upstream devices, a label shall be provided. Series combination ratings shall cover all trip ratings of installed frames. It shall state the conditions of the UL series ratings including:
  - 1. Size and type of upstream device.
  - 2. Branch devices that can be used.
  - 3. UL series short circuit rating.

**Construction**

- A. All interiors, with the exception of the branch circuit breakers, shall be completely factory assembled with main breakers, main lugs, or no main device.
- B. Interiors shall be designed so that circuit breakers can be replaced without disturbing adjacent units and without removing the main bus connectors and shall be designed so that circuits may be changed without machining, drilling, or tapping.
- C. Physical means shall be provided to prevent the installation of more overcurrent devices than that number for which the enclosure was designed, rated and approved. Half-size breakers shall have a UL listed rejection tab over the line terminals. Loadcenter interiors must have notched stabs to accept these rejection tab class CTL breakers, if required and approved.

**Bus**

- A. Busbars for the main and cross connectors shall be [tin-plated aluminum] [copper] in accordance with Underwriters Laboratories standards. Busing shall be braced throughout to conform to industry standard practice governing short-circuit stresses in loadcenters.

**Note:** Note to spec writer—select one (copper available in limited ratings).

- B. Neutral busing shall have a suitable lug for each outgoing feeder requiring a neutral connection of same ampacity as branch.

**Wiring/Termination**

- A. All wire connectors and terminals shall be of the anti-turn solderless type and shall be suitable for copper or aluminum wire of the sizes indicated. All connectors must meet the "Requirements for Wire Connectors and Soldering Lugs" as stated in UL 486B.
- B. All loadcenters where marked shall be suitable for use with 60 °C or 75 °C rated wire.

**Circuit Breakers**

- A. Circuit breakers shall be molded case type. Circuit breakers shall have four-rivet construction (GFI Type—5 rivets). Multipole circuit breakers shall be of a stack pole design to provide electrical phase isolation.
- B. Each pole of the circuit breaker will provide inverse time delay overload and instantaneous short-circuit protection by means of both thermal and magnetic sensors.
- C. The circuit breaker calibration shall not be affected by environmental changes in relative humidity. The thermal bimetal element shall be welded to the steel frame and calibration shall be set independent of the molded case by computer controlled equipment.
- D. All circuit breakers shall be operated by a toggle-type handle and multipole circuit breakers shall have an internal common trip mechanism. The circuit breakers shall incorporate trip mechanisms that are mechanically trip-free from the handle. The handle position shall provide visual trip indication.
- E. Contacts shall be of non-welding silver alloy.
- F. All circuit breakers shall have the trip rating inscribed on the handle on each circuit breaker pole. Also, unique color-coded cases that indicate the UL listed 10 kA or 22 kA interrupting ratings. Breakers shall be able to be used as main or branch disconnect devices.
- G. Branch circuit breakers may also be used in the 1/2-inch (12.7 mm) per pole ratings that include two-pole 1-inch (25.4 mm) wide modules and four-pole 2-inch (50.8 mm) wide modules. Two-pole circuit breakers must incorporate a common trip mechanism.
- H. Circuit breakers shall be completely enclosed in a molded case of thermoset material. No internal aluminum parts shall be used. All internal ferrous parts shall be plated to prevent corrosion.
- I. All terminals shall be listed for use with copper or aluminum conductors. Terminals shall be of the box lug or clamp type design. The terminals shall meet UL 486B requirements and shall be suitable for use with either 60 °C or 75 °C wire.
- J. The calibrated bimetal assembly shall be mechanically isolated from the load terminal using a flexible braided copper shunt wire, such that movement of the terminals due to twisting and overtorquing does not affect breaker calibration.
- K. Breakers shall be SWD rated and/or HACR rated as required.
- L. Arc Fault Interrupting circuit breakers, (AFI), shall be provided on all 15 and 20 A single-phase 120/240 Vac circuits except those indicated as remote controlled breakers. AFI breakers shall be “Classified for mitigating the effects of arcing faults,” or conforming to UL Standard 1699 and as defined by Article 210.12 Section A of the 1999 NEC Code.

**Surge Protection Devices**

See Volume 1, Tab 2 for complete details on surge protection.

**Enclosures**

- A. Loadcenter shall have NEMA Type 1 general purpose or NEMA Type 3R rainproof enclosures as indicated on the drawings and shall be surface or combination flush/surface mounted except where noted.
- B. Boxes shall be made from galvanized sheet steel having multiple knockouts. Rainproof boxes shall use galvanized steel or an approved coating system which meets or exceeds standards for outdoor NEMA Type 3R enclosures. Boxes shall be of sufficient size to provide at least a minimum code gutter space on all sides.
- C. The deadfront shall have an easy adjustment feature for flush applications.
- D. Boxes shall be factory assembled into a single rigid structure.
- E. Unless otherwise noted on drawings, hinged doors covering all circuit breaker handles shall be included in all trims. Trim doors shall not uncover any live parts in making the circuit breaker handles accessible. If key locks are required, all locks shall be keyed alike.
- F. Combination trims for flush and surface panels shall be flat and shall overlap the box by at least 5/8-inch (15.9 mm) all around. Trims shall be mounted by a screwdriver without the need for special tools.

**Finish**

- A. Trims shall be bonderized and finished with a light gray ANSI-61 enamel. The paint finish shall be of a type to which field applied paint will adhere.

**Factory Testing**

- A. The standard factory tests shall be performed on the equipment provided under this section. All tests shall be in accordance with the latest version of UL and NEMA.

### BR Loadcenters

#### Description

#### Service

Single-phase, three-wire, 120/240 Vac

Three-phase, four-wire, 208Y/120 Vac  
Three-phase, three-wire, 240 Vac delta

#### Short-Circuit Current Rating

10 kAIC: All single- and three-phase loadcenters 70–225 A, 8 to 42 circuits  
22 kAIC: All convertible loadcenters using 125 A rated Type BRH main breakers or selected factory installed 125 A rated Type BRH main breaker

25 kAIC: All convertible and factory-installed single-phase loadcenters rated 150 and 200 A using Type CSR main breakers

#### Main Breaker/Main Lug Loadcenters

Single-phase  
Main breaker: 100, 125, 150, 200, 225, 400, 600 A  
Main lugs: 70, 125, 150, 200, 225, 400, 600 A

Three-phase  
Main breaker: 100, 125, 150, 200, 225, 400, 600 A  
Main lugs: 100, 125, 150, 200, 225, 400, 600 A

#### Convertible Loadcenters

Main breaker: single-phase up to 200 A and three-phase up to 225 A

Main lugs: single-phase up to 200 A and three-phase up to 150 A

#### Branch Breakers

Types BR, BRH and BRHH: 10–150 A, single-, two- and three-pole; selected amperage available in switching duty, HACR, shunt trip and high magnetic setting  
Type GFTCB: 15–60 A  
Types BJ and BJH: 125–225 A; two- and three-pole  
Type BD Twin: 10–50 A; two of one-pole; take one 1-inch (25.4 mm) space

Type BQ and BQC Multibreaker: 15–30 A. Two of two-pole or one two-pole and two one-pole; takes two 1-inch (25.4 mm) spaces  
Type BRW: 15–30 A; two-pole water heater breakers  
Type BRSN: 15–30 A; two-pole switching neutral breakers  
Type BR 15–100 A; two-pole, 240 Vac delta breakers  
BR-AFCL arc fault circuit interrupter

#### Enclosures

NEMA Type 1 indoor  
NEMA Type 3R outdoor

NEMA 4X  
Meets or exceeds UL requirements for indoor or outdoor applications

#### Loadcenter and Breaker Accessories

Branch circuit breaker:  
Auxiliary components    Hold-down kits    Handle ties  
Lockoffs                    Lockdogs  
Complete line of ground bar kits 5, 10, 14 and 21 circuit, some with additional #2/0 lugs; each terminal will accommodate: (3) #14–#10 Cu/Al or (1) #14–#4 Cu/Al  
Main and sub-feed lugs 125, 150, 225 A—two- and three-pole  
Shunt trips

Surge protection:  
Single-phase plug-on surge protector    Single-phase bottle type surge protector  
Three-phase bottle type surge protector    Single-phase whole home surge protector  
Universal rainproof conduit hubs  
Group One: 3/4, 1, 1-1/4, 1-1/2, 2 inches (19.1, 25.4, 31.8, 38.1, 50.8 mm)  
Group Two: 2, 2-1/2, 3 inches (50.8, 63.5, 76.2 mm)  
Adapter plate

#### Bussing

Tin-plated aluminum as standard

Limited copper bus panels available

**Dimensions**

Approximate Dimensions in Inches (mm)

**Residential/Commercial/New York City Loadcenters, Unit Enclosures—Box Sizes****Note:** Box sizes do not include covers/fronts.**Residential Loadcenters—NEMA Type 1 Indoor**

Box Size	Height	Width	Depth
A1	15.00 (381.0)	11.25 (285.8)	3.75 (95.3)
B1	16.75 (425.5)	14.31 (363.5)	3.88 (98.4)
B2	18.75 (476.3)	14.31 (363.5)	3.88 (98.4)
C1	21.00 (533.4)	14.31 (363.5)	3.88 (98.4)
C2	23.00 (584.2)	14.31 (363.5)	3.88 (98.4)
C4	27.00 (685.8)	14.31 (363.5)	3.88 (98.4)
D1	29.13 (739.8)	14.31 (363.5)	3.88 (98.4)
G1	34.13 (866.8)	14.31 (363.5)	3.88 (98.4)
L1	39.00 (990.6)	14.31 (363.5)	3.88 (98.4)
L2	45.00 (1143.0)	14.31 (363.5)	3.88 (98.4)
L3	48.38 (1228.3)	14.31 (363.5)	3.88 (98.4)
2	8.63 (219.1)	5.00 (127.0)	3.50 (88.9)
3	9.44 (239.7)	4.50 (114.3)	3.00 (76.2)
4	13.00 (330.2)	11.00 (279.4)	3.56 (90.5)
5	9.44 (239.7)	4.50 (114.3)	3.00 (76.2)
6	12.00 (304.8)	6.88 (174.6)	4.50 (114.3)
7	13.00 (330.2)	11.00 (279.4)	3.56 (90.5)
9	14.50 (368.3)	6.50 (165.1)	3.50 (88.9)

**Residential Loadcenters—NEMA Type 3R Outdoor**

Box Size	Height	Width	Depth
B1R	16.75 (425.5)	14.31 (363.5)	5.19 (131.8)
B2R	18.75 (476.3)	14.31 (363.5)	5.19 (131.8)
C3R	25.00 (635.0)	14.31 (363.5)	5.19 (131.8)
D1R	29.13 (739.8)	14.31 (363.5)	5.19 (131.8)
G1R	34.13 (866.8)	14.31 (363.5)	5.19 (131.8)
L1R	39.00 (990.6)	14.31 (363.5)	5.19 (131.8)
L2R	45.00 (1143.0)	14.31 (363.5)	5.19 (131.8)
L3R	48.75 (1238.2)	14.31 (363.5)	5.19 (131.8)
2R	8.63 (219.1)	5.00 (127.0)	3.50 (88.9)
3R	9.44 (239.7)	4.50 (114.3)	3.00 (76.2)
4R	13.00 (330.2)	11.00 (279.4)	3.56 (90.5)
5R	9.44 (239.7)	4.50 (114.3)	3.00 (76.2)
6R	11.75 (298.5)	6.50 (165.1)	4.50 (114.3)
7R	13.00 (330.2)	11.00 (279.4)	3.56 (90.5)
8R	27.00 (685.8)	10.50 (266.7)	4.75 (120.7)
9R	14.25 (362.0)	6.50 (165.1)	4.00 (101.6)
C1R	21.00 (533.4)	14.31 (363.5)	5.19 (131.8)

**Residential Loadcenters—NEMA Type 1 Indoor (BR Plug-On Neutral)**

Box Size	Height	Width	Depth
X0	16.90 (429.3)	14.30 (363.2)	3.80 (96.5)
X1	18.90 (480.1)	14.30 (363.2)	3.80 (96.5)
X2	21.10 (535.9)	14.30 (363.2)	3.80 (96.5)
X3	23.10 (586.7)	14.30 (363.2)	3.80 (96.5)
X4	27.10 (688.3)	14.30 (363.2)	3.80 (96.5)
X5	29.20 (741.7)	14.30 (363.2)	3.80 (96.5)
X6	34.20 (868.7)	14.30 (363.2)	3.80 (96.5)
X7	37.10 (942.3)	14.30 (363.2)	3.80 (96.5)
X8	39.10 (993.1)	14.30 (363.2)	3.80 (96.5)
X9	45.10 (1145.5)	14.30 (363.2)	3.80 (96.5)
X10	48.60 (1234.4)	14.30 (363.2)	3.80 (96.5)

**Commercial Loadcenters—NEMA Type 1 Indoor**

Box Size	Height	Width	Depth
19	44.00 (1117.6)	16.16 (410.4)	6.25 (158.8)
20	44.00 (1117.6)	16.16 (410.4)	6.25 (158.8)
22	54.00 (1371.6)	16.22 (412.0)	6.31 (160.3)
24	66.50 (1689.1)	16.22 (412.0)	6.31 (160.3)

**Commercial Loadcenters—NEMA Type 3R Outdoor**

Box Size	Height	Width	Depth
42	38.00 (965.2)	16.31 (414.3)	6.38 (161.9)
43	44.00 (1117.6)	16.31 (414.3)	6.38 (161.9)
46	54.00 (1371.6)	16.31 (414.3)	6.38 (161.9)
47	66.56 (1690.7)	16.31 (414.3)	6.38 (161.9)

**New York City Loadcenters—NEMA Type 1 Indoor**

Box Size	Height	Width	Depth
A	38.00 (965.2)	18.13 (460.4)	5.00 (127.0)
B	44.00 (1117.6)	18.13 (460.4)	5.00 (127.0)
C	66.50 (1689.1)	18.13 (460.4)	6.25 (158.8)

**ECC Unit Enclosures—NEMA Type 1 Indoor**

Height	Width	Depth
23.25 (590.6)	8.88 (225.4)	4.50 (114.3)

**ECC Unit Enclosures—NEMA Type 3R Outdoor**

Height	Width	Depth
23.68 (601.7)	9.31 (236.5)	5.44 (138.1)

Approximate Dimensions in Inches (mm)

### Residential Loadcenter Knockouts

#### Knockouts for Box Sizes A1, B1, B2, C1, C2, C4, D1, G1, L1, L2, B1R, B2R, C1R, C3R, D1R, G1R, L1R, L2R

Code	Diameter				
A	0.50 (12.7)	0.75 (19.1)	—	—	—
B	0.50 (12.7)	—	—	—	—
C	0.50 (12.7)	1.25 (31.8)	1.50 (38.1)	2.00 (50.8)	2.50 (63.5)
D	1.25 (31.8)	1.25 (31.8)	2.00 (50.8)	2.50 (63.5)	—
E	0.50 (12.7)	0.75 (19.1)	1.00 (25.4)	—	—
F	0.50 (12.7)	0.75 (19.1)	1.00 (25.4)	1.50 (38.1)	2.00 (50.8)
G	1.25 (31.8)	1.50 (38.1)	2.00 (50.8)	—	—
H	0.50 (12.7)	0.75 (19.1)	1.00 (25.4)	1.25 (31.8)	1.50 (38.1)
I	1.00 (25.4)	1.25 (31.8)	1.50 (38.1)	2.00 (50.8)	2.50 (63.5)
J	1.00 (25.4)	1.25 (31.8)	1.50 (38.1)	—	—

#### Residential NEMA Type 1 Indoor and NEMA Type 3R Outdoor Enclosures

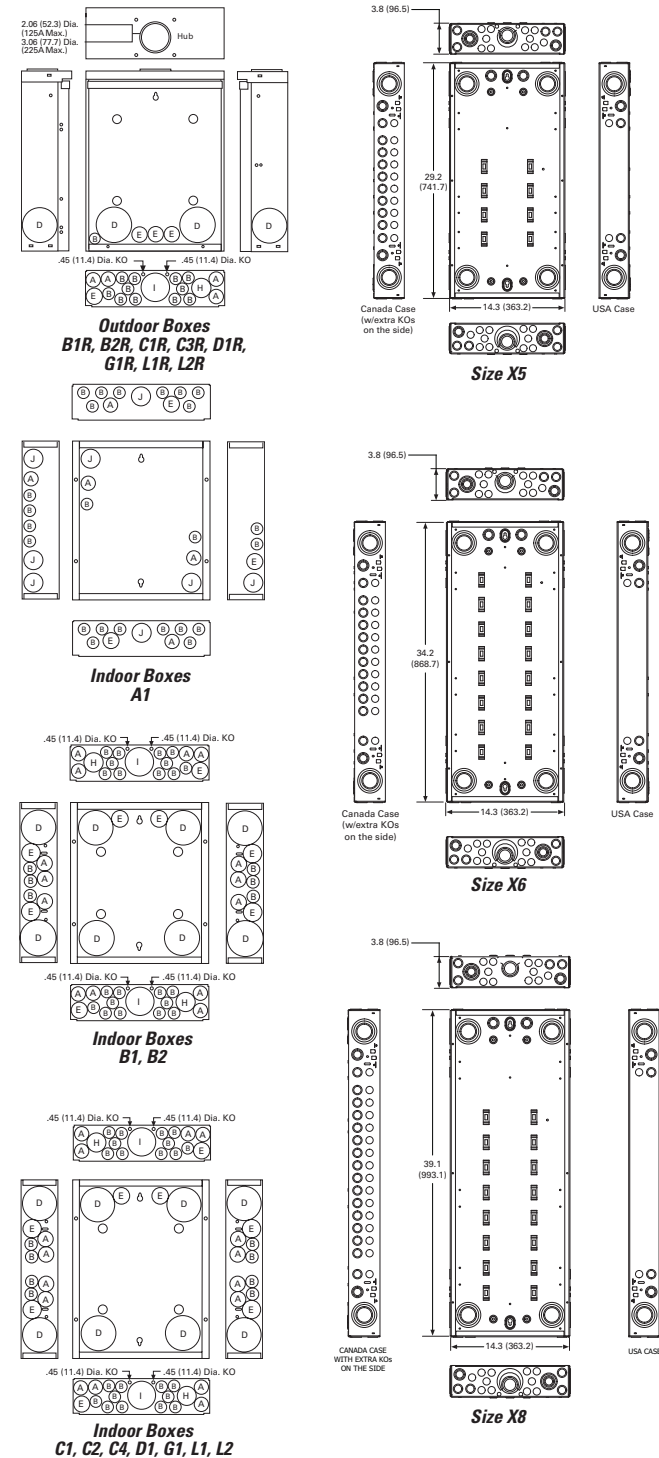

# 1.2

## Loadcenters and Circuit Breakers

### Type BR Loadcenters and Circuit Breakers

1

Approximate Dimensions in Inches (mm)

#### Knockouts for Box Sizes 3, 4, 5, 6, 7, 9, 2R, 3R, 4R, 5R, 6R, 7R, 8R, 9R

Code	Diameter			
A	0.50 (12.7)	—	—	—
B	0.50 (12.7)	0.75 (19.1)	—	—
C	0.50 (12.7)	0.75 (19.1)	1.00 (25.4)	—
D	0.50 (12.7)	0.75 (19.1)	1.00 (25.4)	1.25 (31.8)
E	0.75 (19.1)	1.00 (25.4)	1.25 (31.8)	—
F	0.75 (19.1)	1.00 (25.4)	1.25 (31.8)	1.50 (38.1)
G	1.00 (25.4)	1.25 (31.8)	1.50 (38.1)	—
H	1.00 (25.4)	1.25 (31.8)	1.50 (38.1)	2.00 (50.8)
I	1.25 (31.8)	1.50 (38.1)	2.00 (50.8)	—

#### Residential NEMA Type 1 Indoor and NEMA Type 3R Outdoor Enclosures

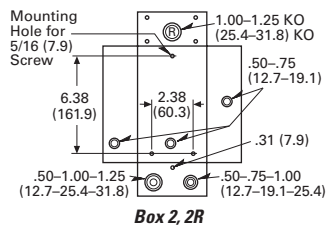

Box 2, 2R

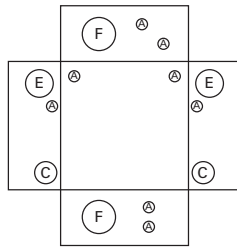

Box 3

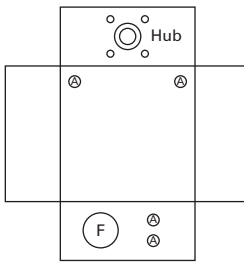

Box 3R

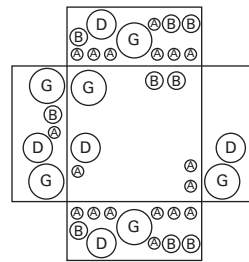

Box 4

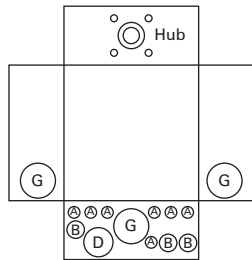

Box 4R

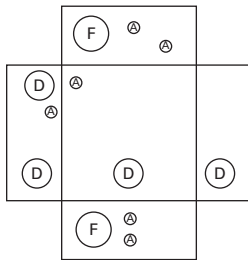

Box 5

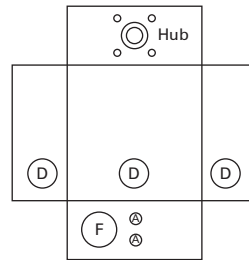

Box 5R

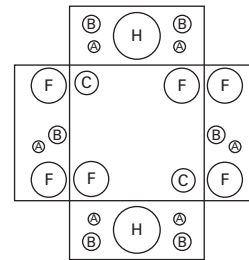

Box 6

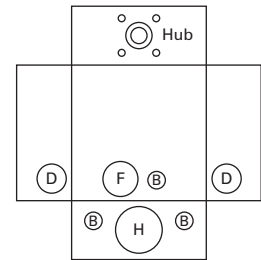

Box 6R

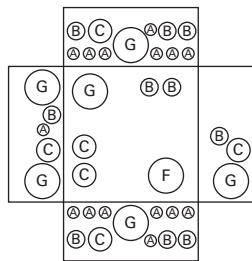

Box 7

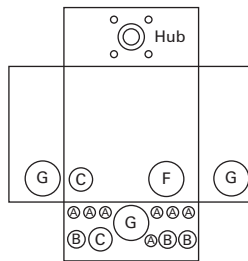

Box 7R

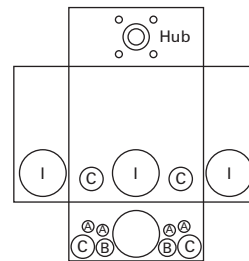

Box 8R

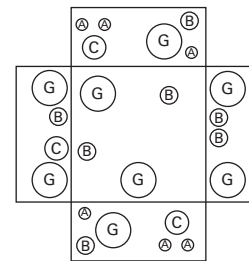

Box 9

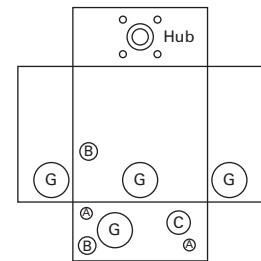

Box 9R

Approximate Dimensions in Inches (mm)

### Commercial Loadcenter Knockouts

#### NEMA Type 1 Indoor Commercial Enclosures Knockouts for Box Sizes 19, 20, 22, 24

Code	Diameter			
A	0.50 (12.7)	—	—	—
B	0.50 (12.7)	0.75 (19.1)	—	—
C	0.75 (19.1)	1.00 (25.4)	1.50 (38.1)	—
D	1.50 (38.1)	2.00 (50.8)	2.50 (63.5)	3.00 (76.2)
E	2.00 (50.8)	2.50 (63.5)	3.00 (76.2)	—
F	2.50 (63.5)	3.00 (76.2)	3.50 (88.9)	—

#### NEMA Type 3R Outdoor Commercial Enclosures Knockouts for Box Sizes 42, 43, 46, 47

Code	Diameter			
A	0.50 (12.7)	—	—	—
B	0.50 (12.7)	0.75 (19.1)	—	—
C	0.75 (19.1)	1.00 (25.4)	1.25 (31.8)	—
D	1.50 (38.1)	2.00 (50.8)	2.50 (63.5)	—
E	2.00 (50.8)	2.50 (63.5)	3.00 (76.2)	—
F	2.50 (63.5)	3.00 (76.2)	3.50 (88.9)	—
G	1.25 (31.8)	1.50 (38.1)	2.00 (50.8)	2.50 (63.5)
H	3.25 (82.6) Sq.	—	—	—

### Unit Enclosure Knockouts, Types ECB and ECC Knockouts

Code	Diameter			
<b>NEMA Type 1 Indoor (Flush and Surface Trims)</b>				
A	0.50 (12.7)	—	—	—
B	1.25 (31.8)	1.50 (38.1)	1.75 (44.5)	2.00 (50.8)
<b>NEMA Type 3R Outdoor</b>				
A	0.50 (12.7)	—	—	—
B	1.25 (31.8)	1.50 (38.1)	1.75 (44.5)	2.00 (50.8)

### Indoor Commercial Enclosures

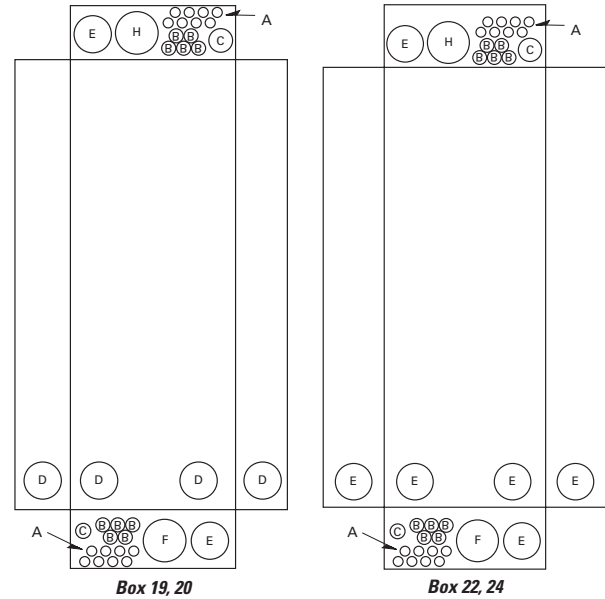

### Outdoor Commercial Enclosures

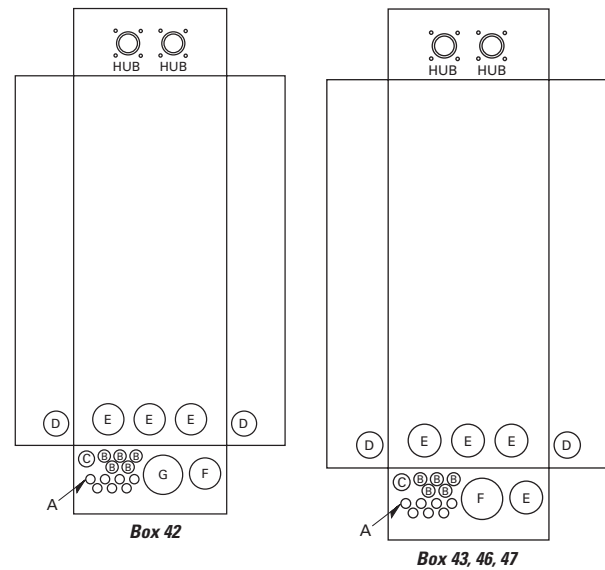

### Unit Enclosure Knockouts

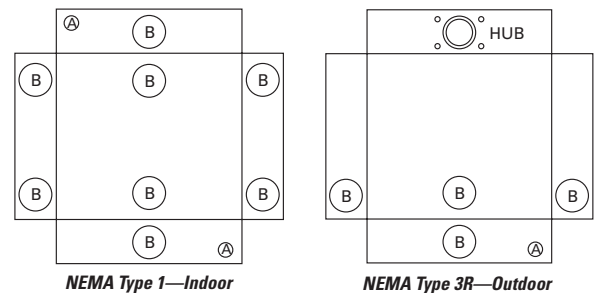



**BR Circuit Breakers**



**Contents**

<i>Description</i>	<i>Page</i>
Overview . . . . .	<b>V1-T1-42</b>
BR Specialty Products	
BR Plug-On Neutral Loadcenters . . . . .	<b>V1-T1-57</b>
BR Quick Connect Neutral Loadcenters . . . . .	<b>V1-T1-60</b>
Spa Panels . . . . .	<b>V1-T1-61</b>
Riser Panel . . . . .	<b>V1-T1-62</b>
Type BR Renovation Loadcenter . . . . .	<b>V1-T1-63</b>
BR Loadcenter Options and Accessories	
Type BR Retrofit Interior Kits . . . . .	<b>V1-T1-64</b>
Type BR Mechanical Interlock Kits . . . . .	<b>V1-T1-68</b>
BR Circuit Breakers	
Product Selection . . . . .	<b>V1-T1-81</b>
Options and Accessories . . . . .	<b>V1-T1-88</b>
Wiring Diagrams . . . . .	<b>V1-T1-90</b>

**BR Circuit Breakers**

**Product Description**

**Plug-On Branch Feeder Type Arc Fault Circuit Breakers, Type BR—10 kAIC, 120 Vac and 120/240 Vac**

A branch feeder type arc fault circuit interrupter is a device intended to mitigate high current arcing faults in the complete circuit, including connected cords. High current arcing faults can occur from line to neutral or line to ground. These arcing faults are in parallel with the load and produce the most energy of all arcing faults.

The branch feeder type AFCI is required in the 1999 and 2002 National Electrical Code.

The Combination Type AFCI is required in the 2005, 2008, and 2011 National Electrical Code.

**Plug-On Combination Type Arc Fault Circuit Breakers, Type BR—10 kAIC, 120 Vac and 120/240 Vac**

A combination type arc fault circuit interrupter is a device that includes all of the protection offered by the branch feeder AFCI (mitigation of high current arcing faults in the complete circuit, including connected cords). In addition it provides direct detection of persistent low current arcing faults down to 5 amps with associated mitigation of fire hazards in the cords connected to the outlets. High current arcing faults can occur from line to neutral or line to ground. These arcing faults are in parallel with the load and produce the most energy of all arcing faults. The current level of low current arcing faults is limited by the load.

**Plug-On Ground Fault Circuit Breakers, Type GFTCB and GFEP—10/22 kAIC, 120 Vac and 120/240 Vac**

**Ground Fault Application Notes**

Single-pole GFTCBs are designed for use in two-wire, 120 Vac circuits. See **Page V1-T1-90** for a typical wiring configuration.

Two-pole GFTCBs are designed for use in three-wire, 120/240 Vac circuits, 120 Vac multiwire circuits employing common, neutral and two-wire, 240 Vac circuits obtained from a 120/240 Vac source.

**Page V1-T1-90** shows typical wiring configurations for a 120/240 Vac multiwire circuits, and a 240 Vac, two-wire circuit. Note the “panel neutral” conductor connects to the neutral bar, even though the neutral is not included in the load circuit. This connection is necessary to supply a 120 Vac power source to the ground fault sensing circuit.

The figures are shown with a 120/240 Vac, single-phase, three-wire power source, but are also applicable to a 120/208 Vac, three-phase, four-wire power supply.

For all figures, the electrical operation of the GFTCB is not affected by the equipment ground.

**Non-CTL Plug-On Replacement—Circuit Breakers, Type BRD—10 kAIC, 120/240 Vac**

**Non-CTL 10 kAIC for Replacement Purposes Only**

For replacement in enclosures manufactured prior to 1968 with unnotched stabs. Circuit breakers do not have rejection tab.

### Product Selection

#### Plug-On Circuit Breakers, Types BR—10/22/42 kAIC, 120 Vac, 120/240 Vac and 240 Vac

BR120



BR215



BR320



BRH2100



BRX2125



#### Type BR Breakers, 1-Inch (25.4 mm) per Pole 120/240, 10, 22 and 42 kAIC

Ampere Rating	Wire Size Range Cu/Al 60 °C or 75 °C	Single-Pole 120/240 Vac Requires One 1-Inch (25.4 mm) Space 10 per Shelf Carton		Two-Pole 120/240 Vac Common Trip Requires Two 1-Inch (25.4 mm) Spaces 5 per Shelf Carton		42 kAIC		65 kAIC	
		10 kAIC Catalog Number	22 kAIC Catalog Number	10 kAIC Catalog Number	22 kAIC Catalog Number	Catalog Number	Catalog Number	Catalog Number	Catalog Number
10	#14–4	BR110	—	BR210	—	—	—	—	—
15	#14–4	BR115 ①②	BRH115	BR215 ③	BRH215	—	—	—	—
20	#14–4	BR120 ①②	BRH120	BR220 ③	BRH220	—	—	—	—
25	#14–4	BR125	BRH125	BR225 ③	BRH225	—	—	—	—
30	#14–4	BR130	BRH130	BR230 ③	BRH230	—	—	—	—
35	#14–4	BR135	BRH135	BR235 ③	BRH235	—	—	—	—
40	#14–4	BR140	BRH140	BR240 ③	BRH240 ③	—	—	—	—
45	#14–4	—	BRH145	BR245 ③	BRH245	—	—	—	—
50	#14–4	BR150	BRH150	BR250 ③	BRH250 ③	—	—	—	—
55	#14–3	BR150	BRH155	BR255	BRH255	—	—	—	—
60	#8–1/0	BR160	BRH160	BR260	BRH260	BRHH260	BRX260	—	—
70	#8–1/0	BR170	BRH170	BR270	BRH270	BRHH270	BRX270	—	—
80	#8–1/0	—	—	BR280	BRH280	BRHH280	BRX280	—	—
90	#8–1/0	—	—	BR290	BRH290	BRHH290	BRX290	—	—
100	#8–1/0	—	—	BR2100	BRH2100	BRHH2100	BRX2100	—	—
110	#8–1/0	—	—	BR2110	BRH2110	BRHH2110	BRX2110	—	—
125	#4–2/0	—	—	BR2125	BRH2125	BRHH2125	BRX2125	—	—
150	#4–2/0	—	—	BR2150 ④	—	—	—	—	—



#### Notes

- ① One pole, 1-inch (25.4 mm) per pole circuit breakers are available with high magnetic setting for switching large tungsten lamp loads. Add suffix H to catalog number.
- ② Switching duty rated.
- ③ On the black handle breaker, add suffix “B” to the catalog number to obtain a tapped molded opening for proper use with hold-down kits.
- ④ For use as a branch circuit breaker in 400 and 600 ampere panels only.

All Type BR single-, two- and three-pole circuit breakers carry listing for HACR application. For circuit breakers with a shunt trip, add ST suffix.

BR Breakers



**Type BR Breakers, 1-Inch (25.4 mm) per Pole 240 Vac, 10, 22 and 42 kAIC**

Three-Pole 240 Vac  
Common Trip Requires Three  
1-Inch (25.4 mm) Spaces  
5 per Shelf Carton



Ampere Rating	Wire Size Range Cu/Al 60 °C or 75 °C	10 kAIC Catalog Number	22 kAIC Catalog Number
10	#14-4	BR310	—
15	#14-4	BR315 ①	BRH315
20	#14-4	BR320 ①	BRH320
25	#14-4	BR325	BRH325
30	#14-4	BR330	BRH330
35	#14-4	BR335	BRH335
40	#14-4	BR340	BRH340
45	#14-4	BR345	BRH345
50	#14-4	BR350	BRH350
55	#14-3	BR355	BRH355
60	#4-1/0	BR360	BRH360
70	#4-1/0	BR370	BRH370
80	#4-1/0	BR380	BRH380
90	#4-1/0	BR390	BRH390
100	#4-1/0	BR3100	BRH3100

**Plug-On, Dual Purpose Arc Fault / Ground Fault Circuit Breakers, Type BR—10 kAIC, 120 Vac**

BRLAFGF115



**Type BR, 1-Inch (25.4 mm) wide Dual Purpose AF/GF Circuit Breakers ②③**

Poles	Ampere Rating	Configuration	Catalog Number
Single-pole 10 kAIC	15	Combination AFGI / GFCl	BRLAFGF115 ④
			BRAFGF115 ⑤
	20		BRLAFGF120 ④
			BRAFGF120 ⑤
Single-pole 22 kAIC	15	BRHAFGF115 ⑤	
	20	BRHAFGF120 ⑤	

**Plug-On Combination Type Arc Fault Circuit Breakers, Type BR—10 kAIC, 120 Vac and 120/240 Vac**

BRCAF115



**Type BR, 1-Inch (25.4 mm) wide Combination Type AFCI Circuit Breakers**

Poles	Ampere Rating	Configuration	Catalog Number
Single-pole 10 kAIC	15	AFCI	BRCAF115 ⑥
	20	AFCI	BRCAF120 ⑥
Single-pole 22 kAIC	15	AFCI	BRHCAF115 ⑥
	20	AFCI	BRHCAF120 ⑥
Two-pole 10 kAIC	15	AFCI	BRL215CAF
	20	AFCI	BRL220CAF

**Notes**

- ① One pole, 1-inch (25.4 mm) per pole circuit breakers are available with high magnetic setting for switching large tungsten lamp loads. Add suffix H to catalog number.
  - ② Breaker qualifies as combination arc fault, per UL 1699.
  - ③ Breaker qualifies as personnel protection ground fault, (5 mA) per UL 943.
  - ④ These catalog numbers will be obsoleted in Q3, 2018 and replaced with BRAFGF short body breakers.
  - ⑤ Short body replacing BRLAFGF breakers.
  - ⑥ Clamshell packaging available with CS modification code on the end of catalog number.
- All Type BR single-, two- and three-pole circuit breakers carry listing for HACR application. For circuit breakers with a shunt trip, add ST suffix. See **Volume 4** for bolt-on AF/GF breakers; QB1015AFGF, QB1020AFGF, QBH1015AFGF and QBH1020AFGF.

### Plug-On Ground Fault Circuit Breakers, Type GFTCB and GFEP—10/22 kAIC, 120 Vac and 120/240 Vac

Type GFTCB Single-Pole



Type GFTCB Two-Pole



#### Type GFTCB Ground Fault Circuit Breakers—5 Milliampere—1-Inch (25.4 mm) per Pole 120 Vac or 120/240 Vac, 10 kAIC

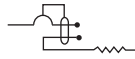

Single-Pole 120 Vac  
Requires One  
1-Inch (25.4 mm) Space  
1 per Shelf Carton  
Catalog Number ①



Two-Pole 120/240 Vac  
Common Trip Requires Two  
1-Inch (25.4 mm) Spaces  
1 per Shelf Carton  
Catalog Number

Ampere Rating	Wire Size Range Cu/Al 60 °C or 75 °C	Single-Pole 120 Vac Requires One 1-Inch (25.4 mm) Space 1 per Shelf Carton Catalog Number ①	Two-Pole 120/240 Vac Common Trip Requires Two 1-Inch (25.4 mm) Spaces 1 per Shelf Carton Catalog Number
15	#14–4	GFTCB115	GFTCB215
20	#14–4	GFTCB120	GFTCB220
25	#14–4	GFTCB125	GFTCB225
30	#14–4	GFTCB130	GFTCB230
40	#14–4	GFTCB140	GFTCB240
50	#14–4	—	GFTCB250 ②
60	#14–6	—	GFTCB260

#### Type GFTCBH Ground Fault Breakers—5 Milliampere—1-Inch (25.4 mm) per Pole 120 Vac or 120/240 Vac, 22 kAIC



Single-Pole 120 Vac  
Requires One  
1-Inch (25.4 mm) Space  
1 per Shelf Carton  
Catalog Number



Two-Pole 120/240 Vac  
Common Trip Requires Two  
1-Inch (25.4 mm) Spaces  
1 per Shelf Carton  
Catalog Number

Ampere Rating	Wire Size Range Cu/Al 60 °C or 75 °C	Single-Pole 120 Vac Requires One 1-Inch (25.4 mm) Space 1 per Shelf Carton Catalog Number	Two-Pole 120/240 Vac Common Trip Requires Two 1-Inch (25.4 mm) Spaces 1 per Shelf Carton Catalog Number
15	#14–4	GFTCBH115	GFTCBH215
20	#14–4	GFTCBH120	GFTCBH220
25	#14–4	GFTCBH125	GFTCBH225
30	#14–4	GFTCBH130	GFTCBH230

#### Type GFEP Ground Fault Equipment Protectors—30 Milliampere—1-Inch (25.4 mm) per Pole 120 Vac or 120/240 Vac, 10 kAIC

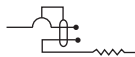

Single-Pole 120 Vac  
Requires One  
1-Inch (25.4 mm) Space  
1 per Shelf Carton  
Catalog Number



Two-Pole 120/240 Vac  
Common Trip Requires Two  
1-Inch (25.4 mm) Space  
1 per Shelf Carton  
Catalog Number

Ampere Rating	Wire Size Range Cu/Al 60 °C or 75 °C	Single-Pole 120 Vac Requires One 1-Inch (25.4 mm) Space 1 per Shelf Carton Catalog Number	Two-Pole 120/240 Vac Common Trip Requires Two 1-Inch (25.4 mm) Space 1 per Shelf Carton Catalog Number
15	#14–4	GFEP115	GFEP215
20	#14–4	GFEP120	GFEP220
25	#14–4	GFEP125	GFEP225
30	#14–4	GFEP130	GFEP230
40	#14–4	—	GFEP240
50	#14–4	—	GFEP250 ②

#### Notes

- ① Available with bell alarm or auxiliary switch. See circuit breaker accessories on [Page V1-T1-88](#).
- ② For use with copper wire only.

# 1.2

## Loadcenters and Circuit Breakers

### Type BR Loadcenters and Circuit Breakers

1

#### CTL Plug-On Circuit Breakers, Type BD Duplex, BQ and BQC Quadplex—10 kAIC, 120/240 Vac

BD2020

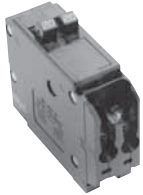

Type BD Duplex  
(UL Type BRD)

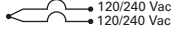

Single-Pole ①  
Requires One 1-Inch  
(25.4 mm) Space  
10 per Shelf Carton

BQ2302115

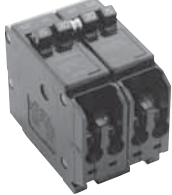

Type BQ Quadplex Independent Trip  
(UL Type BRD)

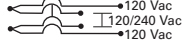

Two-Pole ② and Single-Pole ①  
Requires Two 1-Inch  
(25.4 mm) Spaces  
5 per Shelf Carton

Type BQ Quadplex Independent Trip  
(UL Type BRD)

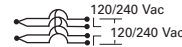

Two-Pole  
Requires Two 1-Inch  
(25.4 mm) Spaces  
5 per Shelf Carton  
120/240 Vac

BQ230230

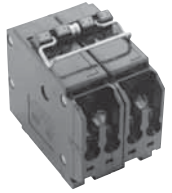

Ampere Rating	Catalog Number	Wire Size Range Cu/Al 65 °C or 75 °C	Ampere Rating			Catalog Number	Ampere Rating		
			Outer Left Single-Pole	Center Two-Pole Independent Trip	Outer Right Single-Pole		Outer Two-Pole Independent Trip	Center Two-Pole Independent Trip	Catalog Number
10–10	<b>BD1010</b>	#14–4	15	20	15	<b>BQ2202115</b>	15	15	<b>BQ215215</b>
15–15	<b>BD1515</b>	#14–4	20	20	20	<b>BQ2202120</b>	15	20	<b>BQ215220</b>
15–20	<b>BD1520</b>	#14–4	15	30	15	<b>BQ2302115</b>	15	30	<b>BQ215230</b>
15–30	<b>BD1530</b>	#14–4	20	30	20	<b>BQ2302120</b>	15	40	<b>BQ215240</b>
20–15	<b>BD2015</b>	#14–4	15	40	15	<b>BQ2402115</b>	15	50	<b>BQ215250</b>
20–20	<b>BD2020</b>	#14–4	20	40	20	<b>BQ2402120</b>	20	20	<b>BQ220220</b>
20–30	<b>BD2030</b>	#14–4	15	50	15	<b>BQ2502115</b>	20	30	<b>BQ220230</b>
25–25	<b>BD2525</b>	#14–4	20	50	20	<b>BQ2502120</b>	20	40	<b>BQ220240</b>
30–15	<b>BD3015</b>	#14–4	—	—	—	—	20	50	<b>BQ220250</b>
30–20	<b>BD3020</b>	#14–4	—	—	—	—	25	25	<b>BQ225225</b>
30–30	<b>BD3030</b>	#14–4	—	—	—	—	30	30	<b>BQ230230</b>
30–40	<b>BD3040</b>	#14–4	—	—	—	—	30	40	<b>BQ230240</b>
30–50	<b>BD3050</b>	#14–4	—	—	—	—	30	50	<b>BQ230250</b>
50–30	<b>BD5030</b>	#14–4	—	—	—	—	40	40	<b>BQ240240</b>
50–50	<b>BD5050</b>	#14–4	—	—	—	—	40	50	<b>BQ240250</b>
—	—	—	—	—	—	—	50	50	<b>BQ250250</b>

#### Notes

- ① All 15 and 20 A single poles are switch-duty rated.
- ② All Type BD duplex and BQ quadplex circuit breakers carry listing for HACR applications.
- ③ Available with bell alarm or auxiliary switch. See circuit breaker accessories on **Page V1-T1-88**.
- ④ For use with copper wire only.

### Non-CTL Plug-On Replacement—Circuit Breakers, Type BRD—10 kAIC, 120/240 Vac

BR2020

#### Class Non-CTL, 1-Inch (25.4 mm) per Pole 10 kAIC—Breakers Do Not Have Rejection Tab Feature



##### Type BR Duplex

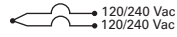

Single-Pole Requires One 1-Inch (25.4 mm) Space  
10 per Shelf Carton

##### Type Brand BRD Quadplex Independent Trip

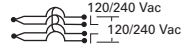

Two-Pole Requires Two 1-Inch (25.4 mm) Spaces  
5 per Shelf Carton

##### Type BRD Quadplex Common Trip Center and Outer Poles

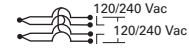

Two-Pole Requires Two 1-Inch (25.4 mm) Spaces  
5 per Shelf Carton

Ampere Rating	120 Vac		120/240 Vac		Catalog Number	120/240 Vac		Catalog Number
	Ampere Rating	Wire Size Range Cu/Al 65 °C or 75 °C	Ampere Rating	Center Two-Pole Independent Trip		Outer Two-Pole Independent Trip	Ampere Rating	
15-15	BR1515	#14-4	15	15	BR415	15	15	BRDC215215
15-20	BR1520	#14-4	20	20	BR420	30	30	BRDC230230
20-15	BR2015	#14-4	30	30	BR430	30	40	BRDC230240
20-20	BR2020	#14-4	20	30	BRD220230	30	50	BRDC230250
30-30	BR3030	#14-4	30	40	BRD230240	—	—	—
30-50	BR3050	#14-4	30	50	BRD230250	—	—	—

#### CTL and Non-CTL Breakers

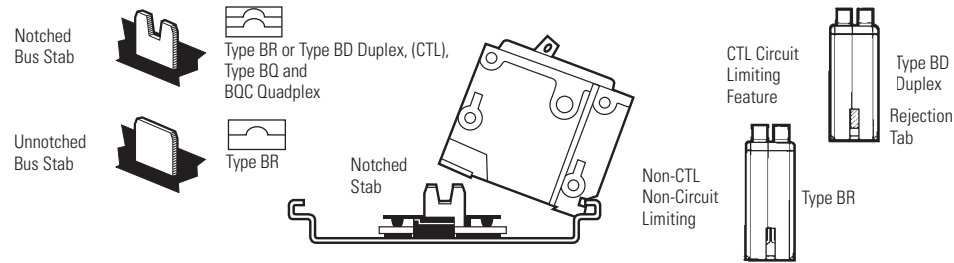

#### 1

#### Common Trip Quadplex Breakers

BQC2302115

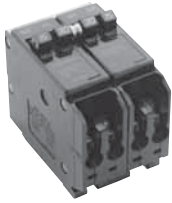

#### Class CTL, 1-Inch (25.4 mm) per Pole 10 kAIC—All Circuit Breakers Have Rejection Tab Feature

Type BQC Quadplex Common Trip Center Poles (UL Type BRD)

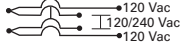

Two-Pole ① and Single-Pole ②  
Requires Two 1-Inch (25.4 mm) Spaces  
5 per Shelf Carton

120 Vac      120/240 Vac      120 Vac

BQC2302115

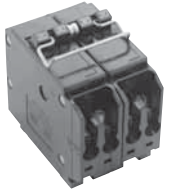

Type BQC Quadplex Common Trip Center and Outer Poles (UL Type BRD)

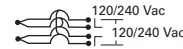

Two-Pole ①  
Requires Two 1-Inch (25.4 mm) Spaces  
5 per Shelf Carton

120/240 Vac

Ampere Rating		Wire Size Range			Ampere Rating		
Outer Left Single-Pole	Center Two-Pole Common Trip	Outer Right Single-Pole	Catalog Number	Cu/Al 65 °C or 75 °C	Outer Two-Pole Common Trip	Center Two-Pole Common Trip	Catalog Number
15	20	15	BQC2202115	#14–4	15	15	BQC215215
15	25	15	BQC2252115	#14–4	15	20	BQC215220
15	30	15	BQC2302115	#14–4	15	30	BQC215230
15	40	15	BQC2402115	#14–4	20	15	BQC220215
15	50	15	BQC2502115	#14–4	20	20	BQC220220
—	—	—	—	#14–4	20	30	BQC220230
—	—	—	—	#14–4	20	40	BQC220240
—	—	—	—	#14–4	20	50	BQC220250
20	15	20	BQC2152120	#14–4	25	25	BQC225225
20	20	20	BQC2202120	#14–4	25	30	BQC225230
20	25	20	BQC2252120	#14–4	30	15	BQC230215
20	30	20	BQC2302120	#14–4	30	30	BQC230230
20	40	20	BQC2402120	#14–4	30	40	BQC230240
20	50	20	BQC2502120	#14–4	30	50	BQC230250
30	50	20	BQC2502030	#14–4	40	30	BQC240230
—	—	—	—	#14–4	40	40	BQC240240
—	—	—	—	#14–4	40	50	BQC240250
—	—	—	—	#14–4	50	20	BQC250220
—	—	—	—	#14–4	50	50	BQC250250

#### Notes

- ① All Type BQC quadplex circuit breakers carry listing for HACR applications.
- ② All 15 and 20 ampere single poles are switch-duty rated.

### Plug-On Circuit Breakers, Types BJ and BJH—10/22 kAIC, 120/240 Vac and 240 Vac

For Use in Single-Phase and Three-Phase Loadcenters—150 Amperes and Above

#### Type BJ

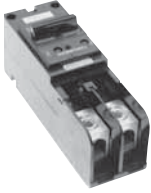

### Types BJ and BJH Breakers, 1-Inch (25.4 mm) per Pole, 120/240 or 240 Vac, 10, 22 kAIC



**Two-Pole 120/240 Vac**  
Common Trip Requires Four  
1-Inch (25.4 mm) Spaces <sup>①</sup>  
10 per Shelf Carton



**Three-Pole 240 Vac**  
Common Trip Requires Six  
1-Inch (25.4 mm) Spaces <sup>②</sup>  
5 per Shelf Carton

Ampere Rating	10 kAIC		Wire Size Range Cu/Al 60 °C or 75 °C	22 kAIC	
	Catalog Number	Catalog Number		Catalog Number	Catalog Number
125	BJ2125	BJH2125	#2–300 kcmil	BJ3125	BJH3125
150	BJ2150	BJH2150	#2–300 kcmil	BJ3150	BJH3150
175	BJ2175	BJH2175	#2–300 kcmil	BJ3175	BJH3175
200	BJ2200	BJH2200	#2–300 kcmil	BJ3200	BJH3200
225	BJ2225	BJH2225	#2–300 kcmil	BJ3225	BJH3225

### Plug-On Special Application Circuit Breakers—10 kAIC, 120 Vac, 120/240 Vac and 240 Vac

#### BRWH215

Water Heater Breaker



### Special Application Circuit Breakers, 1-Inch (25.4 mm) per Pole

#### Water Heater Breakers



**Two-Pole 120/240 Vac**  
Common Trip Requires Two  
1-Inch (25.4 mm) Spaces

With Isolated Line Terminals  
for Separately Metered  
Water Heaters

5 per Shelf Carton

10 kAIC

#### Switching Neutral Breakers

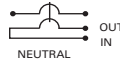

**Two-Pole 120 Vac**  
Common Trip Requires Two  
1-Inch (25.4 mm) Spaces

With Switching Neutral Pole  
for Gasoline Pump Applications

5 per Shelf Carton

10 kAIC

#### 240 V Breakers



**Two-Pole 240 Vac**  
Common Trip Requires Two  
1-Inch (25.4 mm) Spaces

Where Voltage to  
Ground is 240 Vac

5 per Shelf Carton

10 kAIC

#### Non-Automatic Molded Case Switches



**Two-Pole 240 Vac**  
Requires Two  
1-Inch (25.4 mm) Spaces

For Use as Disconnect Contains No  
Magnetic or Thermal Trip Properties

5 per Shelf Carton

5 kAIC

#### BRSN220

Switching Neutral Breaker



Ampere Rating	Catalog Number	Ampere Rating	Catalog Number	Wire Size Range Cu/Al 60 °C or 75 °C	Ampere Rating	Catalog Number	Ampere Rating	Catalog Number
15	BRWH215	15	BRSN215	#14–4	10	BR210H	—	—
20	BRWH220	20	BRSN220	#14–4	15	BR215H	—	—
30	BRWH230	25	BRSN225	#14–4	20	BR220H	—	—
—	—	30	BRSN230	#14–4	25	BR225H	—	—
—	—	—	—	#14–4	30	BR230H	—	—
—	—	—	—	#14–4	35	BR235H	—	—
—	—	—	—	#14–4	40	BR240H	—	—
—	—	—	—	#14–4	45	BR245H	—	—
—	—	—	—	#14–4	50	BR250H	50	BR250NA
—	—	—	—	#14–4	55	BR255H	—	—
—	—	—	—	#4–1/0	60	BR260H	60	BR260NA
—	—	—	—	#4–1/0	70	BR270H	—	—
—	—	—	—	#4–1/0	80	BR280H	—	—
—	—	—	—	#4–1/0	90	BR290H	—	—
—	—	—	—	#4–1/0	100	BR2100H	100	BR2100NA

#### Notes

<sup>①</sup> Breaker uses two 1-inch (25.4 mm) pole spaces on left side and two 1-inch (25.4 mm) pole spaces on right side of loadcenter.

<sup>②</sup> Breaker uses three 1-inch (25.4 mm) pole spaces on left side and three 1-inch (25.4 mm) pole spaces on right side of loadcenter.

If BJ or BJH breakers are used as a main or a back feed device, a hold-down kit is required. See **Page V1-T1-88**.



#### Options and Accessories

THS1



BHLW2



BRQLW



MCBPL (Installed)

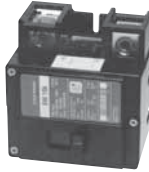

BHLW



BRLW2



#### Field Installation Kits and Parts

##### Description

Ordering Quantity <sup>①</sup> Catalog Number

##### New Products

Padlockable device for locking the handle of BR long body AF/GF breaker into the ON or OFF position **BRLAFGFLOFF**

Padlockable device for locking the handle of BR short body BRCAF, BRAFGF, QBCAF, QBAFGF breakers into the ON or OFF position **BRCAFLOFF**

##### Handle Ties <sup>②</sup>

Handle tie bar for physically joining the handles of two adjacent single-pole Type BR circuit breakers (metal cylinder pin type) 10 **BHT**

Handle tie bar for joining two independent outside poles of Types BQ and BQC Quadplex and outside poles of two Type BD duplex circuit breakers 10 **THOW**

Handle tie bar for joining two adjacent outside poles of Types BQ and BQC Quadplex and outside poles of two Type BD duplex circuit breakers 10 **THS1**

##### Handle Lockoffs <sup>③④</sup>

Padlockable device for locking the handle of single-, two- or three-pole Type BR Circuit Breakers and single-pole of a Type BD Duplex or one independent outside pole of a Type BQ or BQC Quadplex circuit breakers (escutcheon mounted) <sup>⑤</sup> 10 **BRLW**

Padlockable device for locking the handle of a single-pole Type BR circuit breaker (handle mounted) <sup>⑥</sup> 10 **BRLW1**

Padlockable device for locking the handle of a two- and three-pole Type BR circuit breaker (handle mounted) <sup>⑥</sup> 10 **BRLW2**

Padlockable device for locking the handle of a single-pole Type BD Duplex, BQ or BQC Quadplex breaker (handle mounted) <sup>⑥</sup> 10 **BRDL1**

Padlockable device for locking the handle of the two center poles and the two outer poles of a two-pole Types BQ and BQC quadplex circuit breakers (escutcheon mounted) <sup>⑤</sup> 10 **BRQLW**

Padlockable device for locking the handle of main circuit breaker Types CC and CHH into the ON or OFF position (screw mounted) <sup>⑦</sup> 1 **CCPL**

Padlockable device for locking the handle of main breaker Types BW and CSR into the ON or OFF position (escutcheon mounted) <sup>⑤</sup> 1 **MCBPL**

Device used to secure handle in ON or OFF position for single-, two- or three-pole Type BR circuit breakers and single-pole of Type BD duplex and one independent outside pole of Type BQ or BQC Quadplex circuit breakers (escutcheon mounted) <sup>⑤</sup> 10 **BHLW**

Device used to secure handle in ON or OFF position for single-pole Type BR circuit breakers (handle mounted) <sup>⑥</sup> 10 **BHLW1**

Device used to secure handle in ON or OFF position for two- and three-pole Type BR circuit breakers (handle mounted) <sup>⑥</sup> 10 **BHLW2**

Device used to secure handle in ON or OFF position for single-pole Type GFTCB ground fault circuit breakers (handle mounted) <sup>⑥</sup> 10 **BHGW**

Device used to secure handle in ON or OFF position for one independent outside pole of Types BQ and BQC Quadplex or single-pole Type BD duplex circuit breakers (handle mounted) <sup>⑥</sup> 10 **HLW1**

##### Notes

- ① Must be purchased in multiples of ordering quantities indicated.
- ② Handle ties: typically used to join two similar independent single-pole breakers to form a two-pole noncommon trip breaker.
- ③ Handle lockoffs: devices that use a padlock to lock the circuit breaker's handle in the ON or OFF position.
- ④ See table on **Page V1-T1-89** for handle position changeability chart.
- ⑤ Escutcheon mounted: device mounted semipermanently to the face of the circuit breaker and secured by the loadcenter deadfront.
- ⑥ Handle mounted: device mounted directly to the handle by the use of a set screw.
- ⑦ Screw mounted: device permanently mounted to the face of the circuit breaker by the use of a non-removable screw.
- ⑧ Hold-down kits: devices used to secure the circuit breaker to the loadcenter for back-feed main application. See NEC Article 408.36(D). Add "B" suffix to two-pole breaker for tapped hole for hold-down kit (ex. BR230B) for BR breakers below 60 A.

BRHDS125



BRHDK125



BRML



### Field Installation Kits and Parts, continued

Description	Ordering Quantity <sup>①</sup>	Catalog Number
<b>Hold-Down Kits <sup>③</sup></b>		
Hold-down retainer kit for three-pole Type BR circuit breakers in S3100 and 3100R loadcenters only	1	<b>BRHDB</b>
Hold-down screw kit for two- and three-pole Type BR circuit breakers in single-phase MLO loadcenters through 100–125 A	1	<b>BRHDS125</b>
Hold-down screw kit for two- and three-pole Type BR circuit breakers in MLO loadcenters 150–225 A	1	<b>BRHDK125</b>
Hold-down screw kit for two-pole Types BJ and BJH circuit breakers in MLO loadcenters 125–225 A	1	<b>BJHDS</b>
Hold-down screw kit for three-pole Types BJ and BJH circuit breakers in MLO loadcenters 125–225 A	1	<b>BJHDS3P</b>
<b>Main Breaker Lug Kits</b>		
Types CC and CHH main breaker lug kit (2) 300 kcmil	1	<b>CCL300</b>
Types BW/CSR main breaker lug kit (2) 300 kcmil	1	<b>MCBL300</b>
<b>Mechanical Interlocks</b>		
Types BR for two-, three- and four-pole breakers	10	<b>BRML</b>
<b>Padlock Brackets</b>		
BR padlock mounting bracket	10	<b>BRPLOFF</b>
BR three-pole lock-off bracket	10	<b>BRPLOFF3P</b>
BJ two-pole lock-off bracket	10	<b>BJL2P</b>
BJ three-pole lock-off bracket	10	<b>BJL3P</b>

### Shunt Trips, Auxiliary and Alarm Contacts

Description	Catalog Number <sup>②</sup> Suffix Adder
<b>Shunt Trip for Types BW/CSR</b>	
12 Volts	<b>SR12</b>
24 Volts	<b>SR24</b>
120 Volts	<b>SR01</b>
<b>Shunt Trip for Types BR</b>	
120 Volts	<b>ST</b>
<b>Auxiliary Contact for Types BW/CSR</b>	
1NO and 1NC	<b>AL1</b>
2NO and 2NC	<b>AL2</b>
<b>Alarm Contacts for Types BW/CSR</b>	
Types BW/CSR	<b>CR1</b>
<b>Alarm Contacts for Type GFTCB (Single-Pole)</b>	
Alarm contact for GFTCB (single-pole)	<b>W1</b>
1NO and 1NC	<b>W2</b>

### Handle Position Changeability Chart

To Change Handle Position from ON to OFF, or OFF to ON You Must...

Handle Lockoff and Lockdog Types	Remove Padlock	Remove Device	Remove Loadcenter Deadfront
Lockoff escutcheon mounted	Remove	—	—
Lockoff handle mounted	Remove	Remove	—
Lockoff screw mounted	Remove	—	—
Lockdog escutcheon mounted	N/A	Remove	Remove
Lockdog handle mounted	N/A	Remove	—

#### Notes

- ① Must be purchased in multiples of ordering quantities indicated.
- ② Add suffix indicated to end of breaker catalog number.

# 1.2

## Loadcenters and Circuit Breakers

Type BR Loadcenters and Circuit Breakers

### 1 Wiring Diagrams

#### Single-Pole 120 V Load Application Sourced by 120/240 Vac

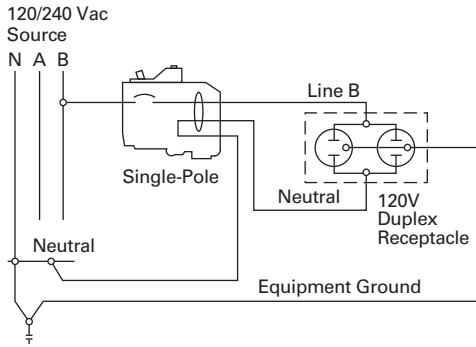

#### Two-Pole Shared Neutral with Duplex Receptacle Application

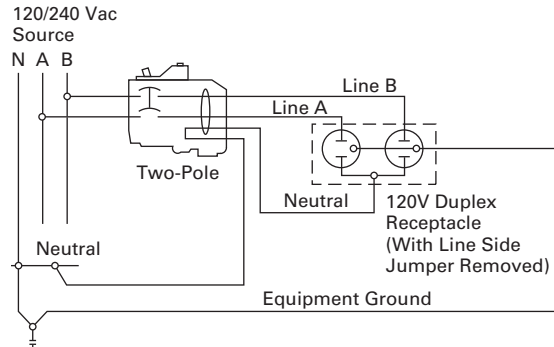

#### Two-Pole Shared Neutral with Multi-Duplex Receptacle Application

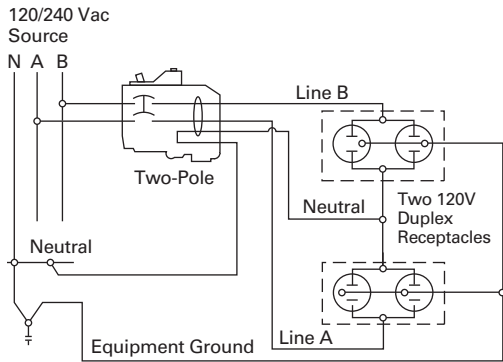

#### Single-Pole 120 V Load Application Sourced by 120/240 Vac

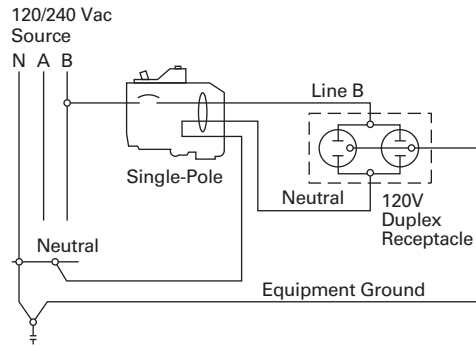

#### Two-Pole 240 V Load Application Sourced by 120/240 Vac

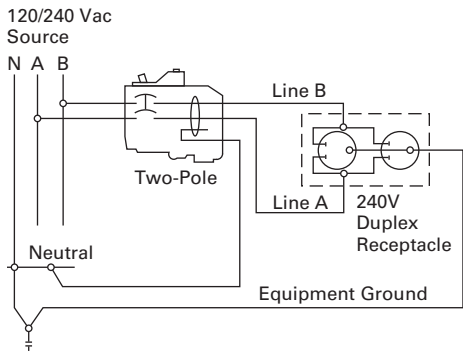

#### Single-Pole 120 V Duplex Receptacle Application

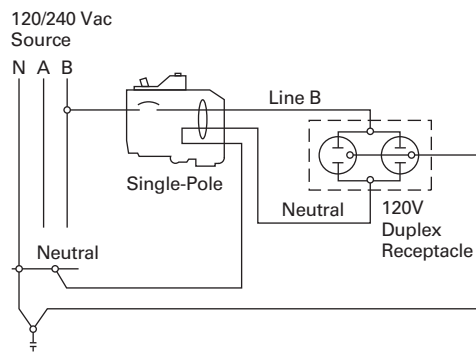

### Two-Pole 120 V Multi-Duplex Receptacle Application

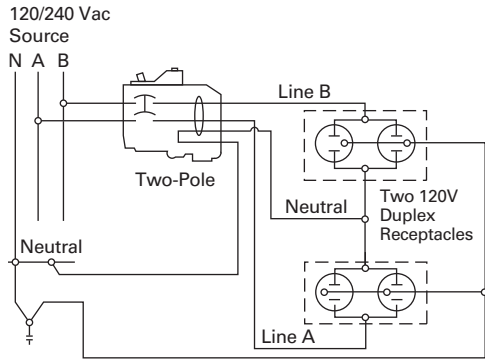

### Two-Pole 120 V Duplex Receptacle Application

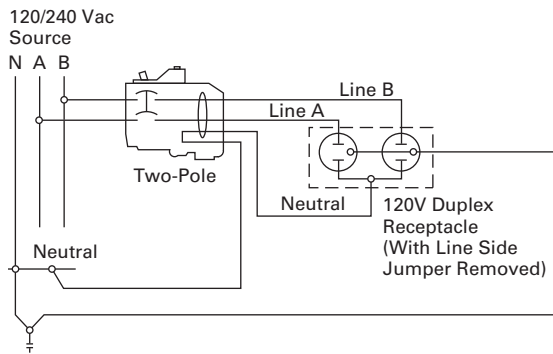

### Two-Pole 240 V Duplex Receptacle Application

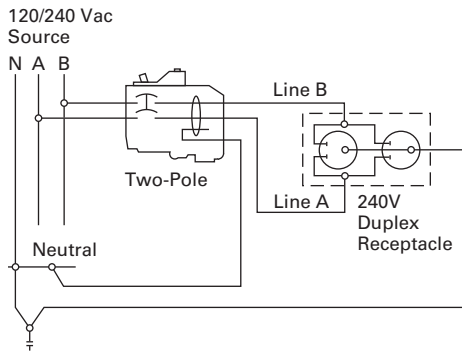



### Product Description

As a leader in the electrical distribution equipment business, Eaton has a unique product offering for equipment manufacturers, panel builders and virtually any OEM that has a need for power distribution within their equipment. The OEM interior offering consists of a wide variety of power distribution options utilizing components from Eaton's CH and BR loadcenter product lines. With high-volume, standardized products, OEMs can expect to receive high-quality products covering configurations meeting virtually any power distribution need.

Coupled with Eaton's expertise in circuit breaker design and manufacturing, OEM interiors provide solid power distribution and circuit protection in a compact, easy-to-install package. Interiors are offered from 2 to 42 circuits and from 70 to 225 A.

### Quality

Built in ISO 9002 certified manufacturing facilities, customers can be assured of the process quality in place for the manufacture of these products. Utilizing the latest in computer-controlled plating, painting, molding, stamping and welding processes, Eaton's customers have come to expect consistent high-quality from shipment to shipment.

### Two Products Offer Design Flexibility

As a manufacturer of two lines of loadcenters, Eaton is in a unique position to offer the broadest range of interiors in the market. Each line has its own unique characteristics that appeal to various segments of the market. OEM interiors are UL recognized components and are listed in either of the following UL files: E8741 or E52977.

### Contents

#### Description

	<i>Page</i>
Standards and Certifications . . . . .	<b>V1-T1-93</b>
Product Selection . . . . .	<b>V1-T1-93</b>

The CH interiors feature 100% copper bus and use the CH 3/4-inch (19.1 mm) wide circuit breaker, which minimizes panel space. Recognized by contractors for its sturdy design, the CH interior will appeal to those customers seeking an industrial quality bolted busbar and the space saving of 3/4-inch (19.1 mm) per bus stab. With a typical 12 circuit CH interior, this space savings amounts to an inch and a half savings over its 1-inch (25.4 mm) counterparts. The stab rating of the CH interiors is 140 A maximum meaning that the handle rating of breakers mounted across from one another may not exceed 140 A.

The BR interiors are manufactured of formed, plated aluminum or copper, and use Eaton's Type BR 1-inch (25.4 mm) wide circuit breaker. This design affords customers the most circuit flexibility as many of these interiors allow the installation of standard single- and two-pole breakers as well as duplex (two poles in a 1-inch (25.4 mm) space) or quadplex (four poles in a 2-inch (50.8 mm) space) breakers.

The stab rating of the BR interiors is 200 A maximum, meaning that the handle rating of the breakers that are mounted across from one another may not exceed 200 A.

The interiors are designed for either horizontal (single-row breaker mounting), or vertical (double-row breaker mounting). To comply with National Electrical Code (NEC) requirements, if mounted horizontally, when the breaker is ON, the handle should be in the UP position. When mounted vertically, the handle toggles from left to right, so this is not a concern.

### Standards and Certifications

#### Class CTL

National Electrical Code Paragraph 384.15 requires branch circuit panelboards to be provided with physical means to prevent the installation of more overcurrent devices than that number of which the enclosure was designed, rated and approved. Class CTL Duplex, Quadplex and twin breakers (identified by a catalog number prefix BD, BQ, BQC and CHT) are equipped with a UL listed rejection tab over the line terminal. All OEM interiors have appropriately notched stabs to accept these rejection tab Class CTL breakers.

Duplex, Quadplex and twin breakers manufactured without the rejection tab (identified by a catalog number prefix BR, BRD and CHT) are available for replacement purposes in older interiors.

#### Federal Specifications

All loadcenter enclosures meet Federal Specifications W-P-115b, Type 1, Class 2 requirements.

All 120/240 V breakers, both 1-inch (25.4 mm), 1/2-inch (12.7 mm) and 3/4-inch (19.1 mm) per pole meet the requirement of Federal Specifications W-C 375B/ Gen Type 1.

#### Canadian Standards Association Listing

All single-pole and two-pole, 120/240 V breakers, both 1-inch (25.4 mm), 1/2-inch (12.7 mm) and 3/4-inch (19.1 mm) per pole, 225 A maximum, are listed as Certified by the Canadian Standards Association, Guide No. 69-11.19, Class 1432, File 18328.

#### Underwriters Laboratories Listing

All grounding bars manufactured comply with Underwriters Laboratories standards and are listed under Guide No. DHJR, File E31424, Volume W, Section 17.

All circuit breakers 10 A and larger comply with the Underwriters Laboratories "Standard for Branch Circuit and Service Circuit-Breakers" UL 489; Guide No. 60 10.2 File E31424, and "Requirements for Wire Connectors and Soldering Lugs," UL 486B, Guide No. 461 10-C File E7830.

All Eaton breakers where marked, are suitable for use with 60/75 °C rated wire, unless otherwise specified.

All devices comply with the 22 kAIC–10 kAIC UL series connected components File DKSY2 of the Recognized Components Index.

#### Lighting and Appliance Panelboards

Lighting and appliance branch circuit panelboards are defined in NEC (Article 408) as "One having more than 10 percent of its overcurrent devices rated 30 A or less for which neutral connections are provided." Article 408 also limits the number of overcurrent devices (branch circuit poles) to a maximum of 42 in any one cabinet. When the 42 poles are exceeded, two or more separate panels are required.

For more details and engineering drawings, see BR.31.02.S.E.



### Product Selection

#### Type CH Loadcenter Interior Assemblies—Copper Bus

Ampere Rating	Maximum Number 1-Inch (24.5 mm) Spaces		UL File Reference	Main Terminal Size (Per Phase)	Standard Package Quantity	Catalog Number
	Single Poles					
<b>Single-Phase Single Row Breaker Mounting—120/240 Vac, Three-Wire</b>						
70	2	2	E8741	(1) #8–#2 AWG Cu/Al	1	CH9MB270
125	2	2	E8741	(1) 2/0–#6 AWG Cu/Al	20	CH2L125INT
<b>Single-Phase Double Row Breaker Mounting—120/240 Vac, Three-Wire</b>						
125	4	4	E8741	(1) 2/0–#14 AWG Cu/Al	20	CH4L125INT
125	8	8	E8741	(1) 2/0–#6 AWG Cu/Al	20	CH8L125INT
125	12	12	E8741	(1) 2/0–#6 AWG Cu/Al	20	CH12L125INT
125	16	16	E8741	(1) 2/0–#6 AWG Cu/Al	20	CH16L125INT
200	12	12	E8741	(1) 300 kcmil–#4 AWG Cu/Al	20	CH12L200INT
200	16	16	E8741	(1) 300 kcmil–#4 AWG Cu/Al	10	CH16L200INT
225	24	24	E8741	(1) 300 kcmil–#4 AWG Cu/Al	10	CH24L225INT
225	32	32	E8741	(1) 300 kcmil–#4 AWG Cu/Al	10	CH32L225INT
225	42	42	E8741	(1) 300 kcmil–#4 AWG Cu/Al	10	CH42L225INT
<b>Three-Phase Double Row Breaker Mounting—208Y/120 Vac, Four-Wire—240 Vac, Three-Wire—120/240 Vac, Four-Wire Delta</b>						
125	12	12	E8741	(1) 2/0–#6 AWG Cu/Al	10	CH12L3125INT
125	18	18	E8741	(1) 2/0–#6 AWG Cu/Al	10	CH18L3125INT
125	24	24	E8741	(1) 2/0–#6 AWG Cu/Al	10	CH24L3125INT
225	24	24	E8741	(1) 300 kcmil–#4 AWG Cu/Al	10	CH24L3225INT
225	30	30	E8741	(1) 300 kcmil–#4 AWG Cu/Al	10	CH30L3225INT
225	42	42	E8741	(1) 300 kcmil–#4 AWG Cu/Al	10	CH42L3225INT

1

BR Loadcenter Interior Assembly



#### Type BR Loadcenter Interior Assemblies—Aluminum Bus

Ampere Rating	Maximum Number 1-Inch (24.5 mm) Spaces	Single Poles	UL File Reference	Main Terminal Size (Per Phase)	Standard Package Quantity	Catalog Number
<b>Single-Phase Single Row Breaker Mounting—120/240 Vac, Three-Wire</b>						
70	2	4	E8741	(1) #8-#2 AWG Cu/Al	20	24INT70B
125	2	4	E8741	(1) 1/0-#14 AWG Cu 2/0-12 AWG Al	20	24INT125B
125	6	12	E52977	(1) 2/0-#14 AWG Cu/Al	20	612INT125SRB
<b>Single-Phase Double Row Breaker Mounting—120/240 Vac, Three-Wire</b>						
125	4	8	E8741	(1) 2/0-#14 AWG Cu/Al	20	48INT125B
125	6	12	E8741	(1) 2/0-#14 AWG Cu/Al	20	612INT125B
125	8	16	E8741	(1) 2/0-#14 AWG Cu/Al	20	816INT125B
125	12	12	E52977	(1) 2/0-#14 AWG Cu/Al	20	1212INT125B
125	12	24	E52977	(1) 2/0-#14 AWG Cu/Al	20	1224INT125B
125	16	24	E52977	(1) 2/0-#14 AWG Cu/Al	20	1624INT125B
125	20	24	E52977	(1) 2/0-#14 AWG Cu/Al	10	2024INT125B
125	24	24	E52977	(1) 2/0-#14 AWG Cu/Al	10	2424INT125B
200	8	16	E52977	(1) 300 kcmil-#1 AWG Cu/Al	20	816INT200B
200	12	24	E52977	(1) 300 kcmil-#1 AWG Cu/Al	20	1224INT200B
200	30	40	E52977	(1) 300 kcmil-#1 AWG Cu/Al	10	3040INT200B
225	42	42	E52977	(1) 300 kcmil-#1 AWG Cu/Al	10	4242INT225B
<b>Three-Phase Double Row Breaker Mounting—208Y/120 Vac, Four-Wire—240 Vac, Three-Wire—120/240 Vac, Four-Wire Delta</b>						
125	12	24	E52977	(1) 2/0-#8 AWG Cu/Al	10	1224INT3125B
150	18	36	E52977	(1) 300 kcmil-#2 AWG Cu/Al	10	1836INT3150B
150	24	42	E52977	(1) 300 kcmil-#2 AWG Cu/Al	10	2442INT3150B
200	30	42	E52977	(1) 300 kcmil-#2 AWG Cu/Al	10	3042INT3200B
225	42	42	E52977	(1) 300 kcmil-#2 AWG Cu/Al	10	4242INT3225B

#### Type BR Loadcenter Interior Assemblies—Copper Bus

Ampere Rating	Maximum Number 1-Inch (24.5 mm) Spaces	Single Poles	UL File Reference	Main Terminal Size (Per Phase)	Standard Package Quantity	Catalog Number
<b>Single-Phase Double Row Breaker Mounting—120/240 Vac, Three-Wire</b>						
125	8	16	E5297	(1) 2/0-#14 AWG Cu/Al	20	816INT125BC
125	12	12	E5297	(1) 2/0-#14 AWG Cu/Al	20	1212INT125BC
200	12	24	E5297	(1) 300 kcmil-#1 AWG Cu/Al	20	1224INT200BC
<b>Three-Phase Double Row Breaker Mounting—208Y/120 Vac, Four-Wire—240 Vac, Three-Wire—120/240 Vac, Four-Wire Delta</b>						
125	12	24	E52977	(1) 2/0-#8 AWG Cu/Al	10	1224INT3125BC
200	12	24	E52977	(1) 300 kcmil-#2 AWG Cu/Al	10	1224INT3200BC

### Neutral Assemblies

Ampere Rating	UL File Rating	Main Incoming Terminal Wire Size Range 60 °C or 75 °C	Number of Terminals		Standard Package Quantity	Figure	Dimensions—Inches (mm)		Catalog Number
			#14–4 AWG Cu/Al	#6–1/0 AWG Cu #6–2/0 AWG Al			Overall Length A	Mounting B	
125	E52977	#6–1/0 AWG Cu #6–2/0 AWG Al	10	—	20	1	5.938 (150.83)	5.400 (137.16)	10NEU125B
125	E52977	#6–1/0 AWG Cu #6–2/0 AWG Al	17	—	20	1	8.388 (213.06)	7.850 (199.40)	17NEU125B
125	E52977	#6–1/0 AWG Cu #6–2/0 AWG Al	20	—	20	1	9.438 (239.73)	8.900 (226.06)	20NEU125B
225	E52977	#1–300 kcmil Cu/Al	24	1	20	2	10.913 (277.19)	10.300 (261.62)	24NEU225B
225	E52977	#1–300 kcmil Cu/Al	35	1	20	2	15.813 (401.65)	15.200 (386.08)	35NEU225B
125	—	—	4	2	1	3	2.266 (57.56)	0.594 (15.09)	BINA

**Figure 1**

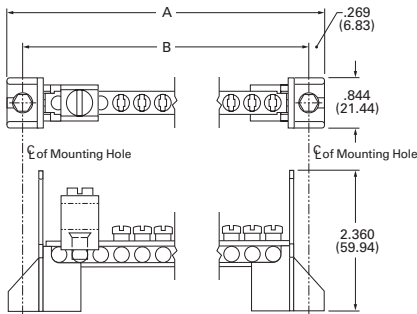

**Figure 2**

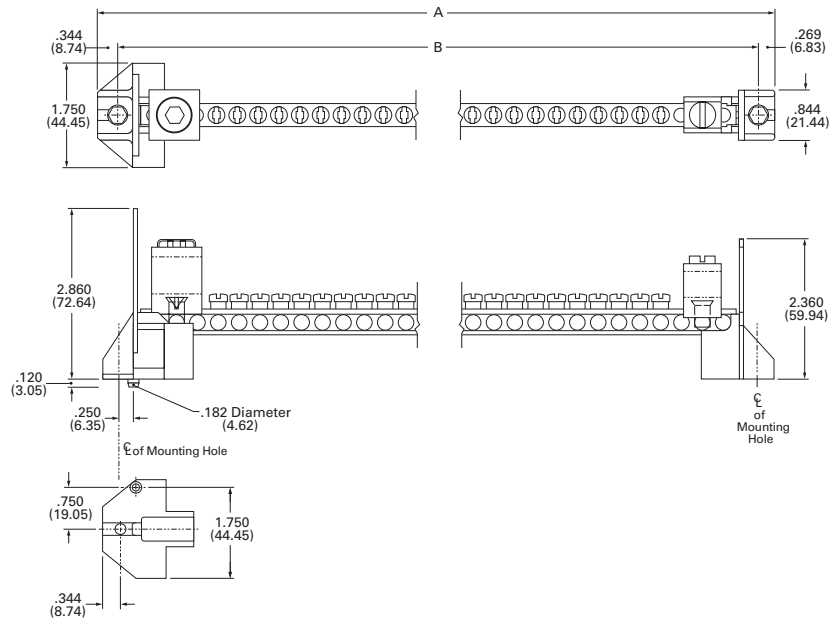

**Figure 3**

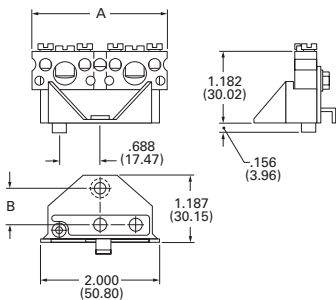



#### Add-on Lugs for Neutral Assemblies

Description	Wire Size Range Cu/Al 60 °C or 75 °C	Ordering Quantity <sup>①</sup>	Catalog Number
Neutral/ground lug	#2/0 maximum	1	NL20
Add-on neutral or ground lug	#3/0 maximum	1	NL30
	300 kcmil maximum	1	NL300

#### GBK14



#### BRGBK39512



#### Ground Bar Kits

Description (See Legend)	Length Inches (mm)	Ordering Quantity <sup>①</sup>	Catalog Number
●○○○○●	2.54 (64.5)	1	GBK5 <sup>②</sup>
●○○○○●○	3.59 (91.2)	1	GBK520 <sup>②</sup>
●○○○○●○○○○	4.29 (109.0)	1	GBK10 <sup>②</sup>
●○○○○●○○○○○■	5.34 (135.6)	1	GBK1020 <sup>②</sup>
— — — — —	4.61 (117.1)	1	GBK13 <sup>②</sup>
●○○○○●○○○○○○○○	5.69 (144.5)	1	GBK14 <sup>②</sup>
●○○○○●○○○○○○○○○■	6.74 (171.2)	1	GBK1420 <sup>②</sup>
●○○○○●○○○○○○○○○○○○○○	8.14 (206.8)	1	GBK21 <sup>②</sup>
●○○○○●○○○○○○○○○○○○○○○■	9.19 (233.4)	1	GBK2120 <sup>②</sup>
⌵ — — — — — ⌵	5.78 (146.8)	1	BRGBK39512 <sup>③④</sup>

#### Ground Bar Legend

- (3) #14–10 Cu/Al or (1) #14–4 Cu/Al
- (1) #6–2/0 Cu/Al
- ⌵ (1) #14–1/0 Cu/Al or (3) #14–10 Cu/Al
- (1) #14–6 Cu/Al or (2) #14–12 Cu/Al
- Mounting Hole

#### Notes

- ① Must be purchased in multiples of ordering quantities indicated.
- ② Distance between mounting holes is 1.75 inches (44.5 mm).
- ③ For single- and three-phase 400 and 600 A applications.
- ④ Distance between mounting holes is 2.34 inches (59.5 mm).

### Enclosed Breakers



### Contents

#### Description

Product Selection .....	V1-T1-98
Dimensions .....	V1-T1-98

#### Page

V1-T1-98
V1-T1-98

### Product Overview

Eaton enclosed breakers offer all the advantages of circuit breakers packed in an enclosure for 240 Vac applications and include a wide range of accessories.

### Product Description

- 100–225 A, 240 Vac maximum
- NEMA 1 general purpose—surface or flush mounting
- NEMA 3R rainproof surface mounting

### Standards and Certifications

- UL 489
- CSA 22.2
- NEMA 250



## Product Selection

### Single-Phase and Three-Phase Circuit Breaker Enclosures—10/25 kAIC

#### ECC225R



#### Type ECC Circuit Breaker Enclosure—Order Type CC Circuit Breaker Separately

Main Ampere Rating	Unit Enclosure Type	Mounting Type	Circuit Breaker Type	Wire Size Range Cu/Al 60 °C or 75 °C	Catalog Number
<b>Single- and Three-Phase—240 Vac Maximum</b>					
100	Indoor	Surface	CCVH factory installed (25 kAIC)	#4–4/0	<b>ECCVH100S</b> ①②③
150	Indoor	Surface	CCVH factory installed (25 kAIC)	#4–4/0	<b>ECCVH150S</b> ①②③
200	Indoor	Surface	CCVH factory installed (25 kAIC)	#2/0–300 kcmil	<b>ECCVH200S</b> ①②③
100	Outdoor	—	CCVH factory installed (25 kAIC)	#4–4/0	<b>ECCVH100R</b> ①②④
150	Outdoor	—	CCVH factory installed (25 kAIC)	#4–4/0	<b>ECCVH150R</b> ①②④
200	Outdoor	—	CCVH factory installed (25 kAIC)	#2/0–300 kcmil	<b>ECCVH200R</b> ①②④
225	Indoor	Flush	CC/CCV/CCH	⑥	<b>ECC225F</b> ②③⑤
225	Indoor	Surface	CC/CCV/CCH	⑥	<b>ECC225S</b> ②③⑤
225	Outdoor	—	CC/CCV/CCH	⑥	<b>ECC225R</b> ②③④⑤

#### CCV2200



#### Circuit Breaker 240 Vac for Use in Type ECC Enclosures

Ampere Rating	Wire Size Range Cu/Al 60 °C or 75 °C for Line Terminals	Type CCV and CC 10 kAIC Catalog Number	Type CCVH/CCH 25 kAIC Catalog Number
<b>Two-Pole</b>			
60	#2–300 kcmil	<b>CCV2060</b>	<b>CCVH2060</b>
70		<b>CCV2070</b>	<b>CCVH2070</b>
80		<b>CCV2080</b>	<b>CCVH2080</b>
90		<b>CCV2090</b>	<b>CCVH2090</b>
100		<b>CCV2100</b>	<b>CCVH2100</b>
125		<b>CCV2125</b>	<b>CCVH2125</b>
150		<b>CCV2150</b>	<b>CCVH2150</b>
175		<b>CCV2175</b>	<b>CCVH2175</b>
200		<b>CCV2200</b>	<b>CCVH2200</b>
225		<b>CCV2225</b>	<b>CCVH2225</b>
<b>Three-Pole</b>			
100	#2–300 kcmil	<b>CC3100</b>	<b>CCH3100</b>
125		<b>CC3125</b>	<b>CCH3125</b>
150		<b>CC3150</b>	<b>CCH3150</b>
175		<b>CC3175</b>	<b>CCH3175</b>
200		<b>CC3200</b>	<b>CCH3200</b>
225		<b>CC3225</b>	<b>CCH3225</b>

#### Shunt Trips and Auxiliary Contacts

Description Type	Volts	Catalog Number Suffix Adder ⑦
<b>Shunt Trip</b>		
CC	12 DC	<b>SR12</b>
CC	24 DC	<b>SR24</b>
CC	120 AC	<b>SR01</b>
CC	208 AC	<b>SR08</b>
CC	240 AC	<b>SR02</b>
CCV	48–127 AC/48–60 DC	<b>SR01</b>
CCV	9–24 AC/12–24 DC	<b>SR02</b>
CCV	208–380 AC/100–127 DC	<b>SR04</b>
<b>Auxiliary Contact</b>		
CC 1N0 and 1NC	—	<b>AL1</b>

#### Dimensions

Approximate Dimensions in Inches (mm)

#### ECC Unit Enclosures—NEMA Type 1 Indoor

Height	Width	Depth
23.25 (590.6)	8.88 (225.4)	4.50 (114.3)

#### ECC Unit Enclosures—NEMA Type 3R Outdoor

Height	Width	Depth
23.68 (601.7)	9.31 (236.5)	5.44 (138.1)

#### Notes

- ① Factory installed CCVH breaker.
- ② Approved for service entrance.
- ③ One ground lug accepting (1) #14–#2 is factory installed. Also, there are pre-drilled holes to accept a GBK5 ground bar.
- ④ Rainproof panels are furnished with hub closures plates. For rainproof hubs, refer to **Page V1-T1-71**.
- ⑤ Order circuit breaker separately.
- ⑥ Wire size is determined by the circuit breaker installed in enclosure.
- ⑦ Add suffix indicated to end of breaker catalog number.

### Classified Breakers



### Contents

<i>Description</i>	<i>Page</i>
Product Selection . . . . .	V1-T1-100
Accessories . . . . .	V1-T1-102
Technical Data. . . . .	V1-T1-102
Wiring Diagrams. . . . .	V1-T1-103

### Product Description

Eaton UL classified Replacement Circuit Breakers are available in both 3/4-inch Type CHQ and 1-inch Type CL, single- and two-pole configurations. These breakers are classified as direct replacements by Underwriters Laboratories. In addition to a UL listing, they also come with a 15-year warranty.

### Specified vs. UL Classified

Specified breakers are listed by the manufacturer of the panelboard for use in a particular panel. This doesn't mean that the panelboard manufacturer produced the specified breaker; it merely means that the panelboard manufacturer has tested the breaker in the panel. In fact, through the years, Eaton has manufactured thousands of breakers for other panelboard manufacturers.

UL classified breakers are produced by one manufacturer for use in place of the breakers specified on the panelboard. Like specified breakers, UL classified breakers have been tested in the panels for which they are approved.

### Testing

Classified breakers are tested extensively in numerous General Electric®, Siemens®, Murray®, Thomas & Betts®, Square D®, and Crouse-Hinds® panels. The tests are conducted with witnesses from Underwriters Laboratories Inc. and involve short-circuit, temperature, and insertion/withdrawal applications. This level of testing ensures that the breakers meet identified standards and have been found suitable by UL for the specified purpose.

### Understanding Classified Breaker Terminology

#### Definitions

Specified circuit breaker—each manufacturer lists the brands of circuit breakers that can be used in their panelboards. Often, manufacturers will not list competitors as specified, even though they are suitable replacements.

Classified circuit breaker—a breaker that is considered suitable, by a qualified third-party organization, for use in another manufacturer's panelboard.

Listed breaker—the listing of a circuit breaker is by an independent third party. Eaton classified breakers are listed by UL.

Labeled breaker—a breaker with a label affixed by an independent third party.

#### 1

### Product Selection



#### Type CHQ Replacement Breakers for Square D Type QO Loadcenters

10 kAIC, 120 and 120/240 Vac

CHQ120 CHQ230



#### Type CHQ Classified Breakers 3/4-Inch (19.1 mm) per Pole 120 or 120/240 Vac, 10 kAIC

Ampere Rating	Wire Size Range Cu/Al 60 °C or 75 °C	 Single-Pole 120/240 Vac Requires One 3/4-Inch (19.1 mm) Space 10 per Shelf Carton		 Two-Pole 120/240 Vac Common Trip Requires Two 3/4-Inch (19.1 mm) Spaces 5 per Shelf Carton	
		Catalog Number	Catalog Number		
15	(1) #14–8	CHQ115	CHQ215		
20	(2) #14–10	CHQ120	CHQ220		
25		CHQ125	CHQ225		
30		CHQ130	CHQ230		
35		CHQ135	CHQ235		
40		CHQ140	CHQ240		
45		CHQ145	CHQ245		
50		CHQ150	CHQ250		
60		—	CHQ260		

#### Type CHQ Surge Arrester

Catalog Number



CHQSA

### Type CL Replacement Breakers for Square D HOMELINE, General Electric, Crouse-Hinds, Thomas & Betts, Murray and ITE®/Siemens Loadcenters

CL\_

#### Type CL Breakers, 1-Inch (25.4 mm) per Pole, 10 kAIC



Ampere Rating	Wire Size Range Cu/Al 60 °C or 75 °C	 Single-Pole 120/240 V Requires One 1-Inch (25.4 mm) Space 10 per Shelf Carton Catalog Number		 Two-Pole 120/240 V Common Trip Requires Two 1-Inch (25.4 mm) Spaces 5 per Shelf Carton Catalog Number	
15	#14-4	CL115	CL215		
20	#14-4	CL120	CL220		
25	#14-4	CL125	CL225		
30	#14-4	CL130	CL230		
35	#14-4	CL135	CL235		
40	#14-4	CL140	CL240		
45	#14-4	CL145	CL245		
50	#14-4	CL150	CL250		

CL\_AF

#### Type CL Classified Arc and Ground Fault Breakers (5 Milliampere), 1-Inch (25.4 mm) per Pole, 10 kAIC



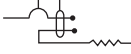

Ampere Rating	Wire Size Range Cu/Al 60 °C or 75 °C	 Single-Pole 120/240 V Requires One 1-Inch (25.4 mm) Space 1 per Shelf Carton Catalog Number	
<b>Arc Fault Breakers</b>			
15	#14-4	CL115AF	
15	#14-4	CL115CAF	
20	#14-4	CL120AF	
20	#14-4	CL120CAF	
<b>Ground Fault Breakers</b>			
15	#14-4	CL115GFT	
20	#14-4	CL120GFT	
30	#14-4	CL130GFT	

CLR\_

#### Type CL Classified Latching Remote Control Smart Breakers™, 1-Inch (25.4 mm) per Pole, 10 kAIC



Ampere Rating	Wire Size Range Cu/Al 60 °C or 75 °C	 Single-Pole 120 V Requires One 1-Inch (25.4 mm) Space 10 per Shelf Carton Catalog Number		 Two-Pole 120/240 V Common Trip Requires Two 1-Inch (25.4 mm) Spaces 5 per Shelf Carton Catalog Number	
15	(2) #14-10	CLRP115	CLRP215		
20	(2) #14-10	CLRP120	CLRP220		
25	(1) #8-6	CLRP125	CLRP225		
30	(1) #8-6	CLRP130	CLRP230		

**Accessories****CHQ Breaker Accessories**

Description	Catalog Number
Breaker handle lock	CHLO

**Technical Data****Arc Fault Application Notes**

An arc fault circuit interrupter is a device intended to provide protection from the effects of arc faults by recognizing characteristics unique to arcing and by functioning to de-energize the circuit when the arc fault is detected. As of January 1, 2002, the National Electrical Code (NEC) requires all branch circuits that supply 125 V, single-phase, 15 and 20 A receptacle outlets installed in dwelling unit bedrooms shall be protected by an arc fault circuit interrupter(s). This includes ceiling lighting (recessed, ceiling fans, etc.) as well as smoke detectors and all other bedroom outlets. The 2005 NEC introduced the application of the Combination Type AFCI for bedroom circuits required as of January 1, 2008. The 2008 NEC expands this application to other living areas.

**Ground Fault Application Notes**

Single-pole GFTCBs are designed for use in two-wire, 120 Vac circuits. Drawing on **Page V1-T1-103** shows a typical wiring configuration.

Two-pole GFTCBs are designed for use in three-wire, 120/240 Vac circuits, 120 Vac multiwire circuits employing common, neutral and two-wire, 240 Vac circuits obtained from a 120/240 Vac source.

Drawings on **Page V1-T1-103** illustrate typical wiring configurations for 120/240 Vac multiwire circuits.

Drawing on **Page V1-T1-103** depicts a 240 Vac, two-wire circuit. Note the “panel neutral” conductor connects to the neutral bar, even though the neutral is not included in the load circuit. This connection is necessary to supply a 120 Vac power source to the ground fault sensing circuit.

The figures are shown with a 120/240 Vac, single-phase, three-wire power source, but are also applicable to a 120/208 Vac, three-phase, four-wire power supply. For all figures, the electrical operation of the GFTCB is not affected by the equipment ground.

**Wiring Diagrams**

**Single-Pole 120 V Load Application Sourced by 120/240 Vac**

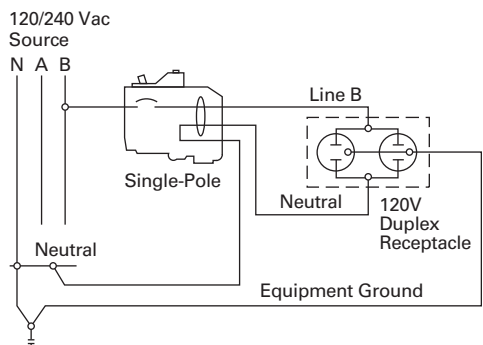

**Two-Pole 240 V Load Application Sourced by 120/240 Vac**

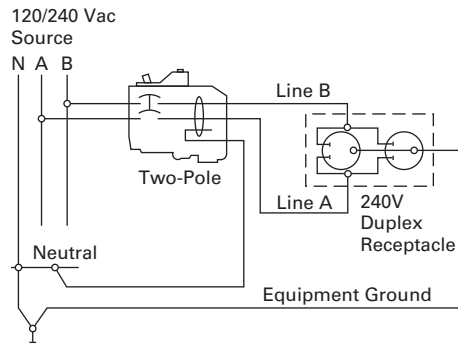

**Two-Pole Shared Neutral with Multi-Duplex Receptacle Application**

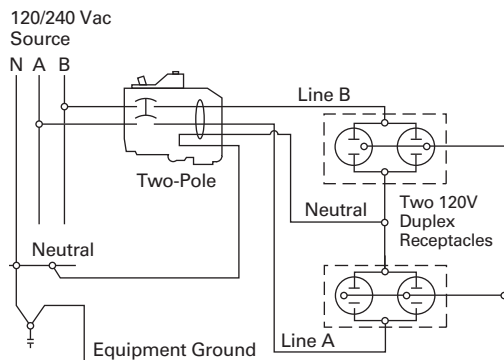

**Two-Pole Shared Neutral with Duplex Receptacle Application**

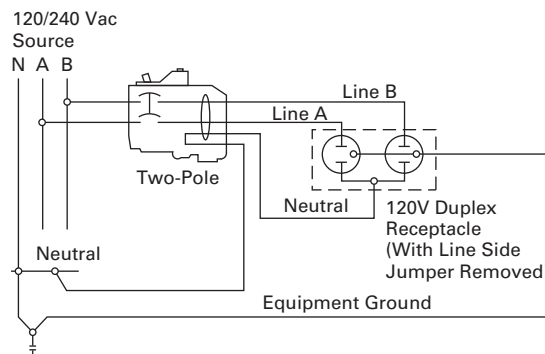

**Single-Pole 120 V Duplex Receptacle Application**

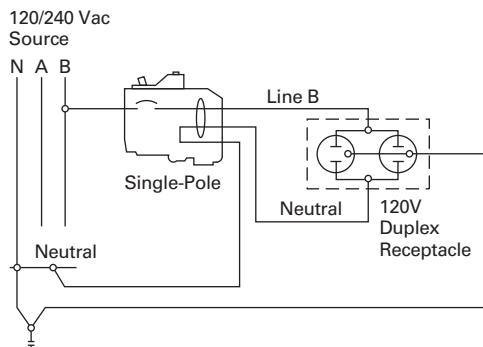

**Two-Pole 120 V Duplex Receptacle Application**

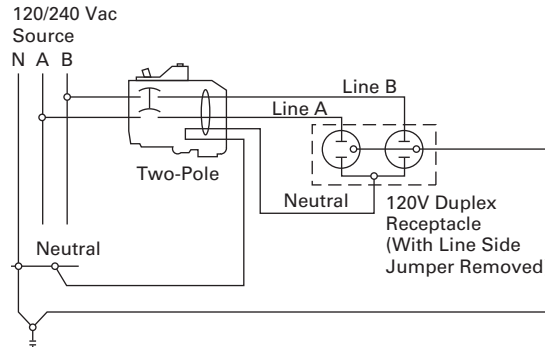

**Two-Pole 120 V Multi-Duplex Receptacle Application**

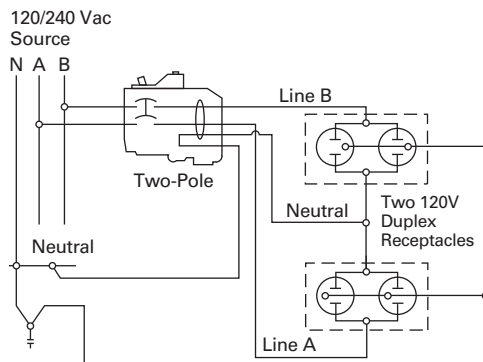

**Two-Pole 240 V Duplex Receptacle Application**

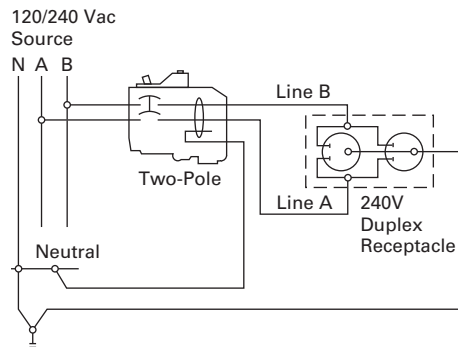



Residential Loadcenters and Breaker Family



<b>1.1</b>	<b>Type CH Loadcenters and Circuit Breakers</b>	
	Overview .....	V1-T1-2
	Single-Phase .....	V1-T1-6
	Three-Phase .....	V1-T1-11
	CH Specialty Products .....	V1-T1-13
	Spa Panels .....	V1-T1-13
	Surge Panel .....	V1-T1-14
	Plug-On Neutral Loadcenter .....	V1-T1-16
	Type CH Renovation Loadcenter .....	V1-T1-17
	Type CH Retrofit Interior Kits .....	V1-T1-18
	Non-Metallic Loadcenter .....	V1-T1-20
	CH Loadcenter Options and Accessories .....	V1-T1-21
	CH Circuit Breakers .....	V1-T1-31
<b>1.2</b>	<b>Type BR Loadcenters and Circuit Breakers</b>	
	Overview .....	V1-T1-42
	Single-Phase .....	V1-T1-54
	Three-Phase .....	V1-T1-54
	BR Specialty Products .....	V1-T1-57
	BR Plug-On Neutral Loadcenters .....	V1-T1-57
	BR Quick Connect Neutral Loadcenters .....	V1-T1-60
	Spa Panels .....	V1-T1-61
	Riser Panel .....	V1-T1-62
	Type BR Renovation Loadcenter .....	V1-T1-63
	Type BR Retrofit Interior Kits .....	V1-T1-64
	BR Loadcenter Options and Accessories .....	V1-T1-66
	BR Circuit Breakers .....	V1-T1-80
<b>1.3</b>	<b>Loadcenter Interiors/OEM Loadcenters</b>	
	Product Description .....	V1-T1-92
	Standards and Certifications .....	V1-T1-93
	Product Selection .....	V1-T1-93
<b>1.4</b>	<b>Enclosed Breakers</b>	
	Product Description .....	V1-T1-97
	Standards and Certifications .....	V1-T1-97
	Product Selection .....	V1-T1-98
	Dimensions .....	V1-T1-98
<b>1.5</b>	<b>Classified Circuit Breakers</b>	
	Product Description .....	V1-T1-99
	Product Selection .....	V1-T1-100
	Accessories .....	V1-T1-102
	Technical Data .....	V1-T1-102
	Wiring Diagrams .....	V1-T1-103



# Revision notes

## Volume 1—Residential and Light Commercial, CA08100002E

Tab 1—Loadcenters and Circuit Breakers

Revision date	Section	Change page(s)	Description
09/25/2018	—	V1-T1-1	Tab TOC updates
09/25/2018	1.2	V1-T1-46, V1-T1-49	Content edits
09/25/2018	1.2	V1-T1-51	Content edits
09/25/2018	1.2	V1-T1-57	Insert new product
09/25/2018	1.2	V1-T1-58, V1-T1-59	Content edits
09/25/2018	1.2	V1-T1-73, V1-T1-74	Content edits
09/25/2018	1.4	V1-T1-95	Content edits



*Powering Business Worldwide*

Eaton Type CH Convertible Family



### Overview

#### Product Description

Loadcenters are enclosures specifically designed to house the branch circuit breakers and wiring required to distribute power to individual circuits. They contain either a main breaker when used at the service entrance point or a main lug when used as a sub-panel to add circuits to existing service. The main breaker protects the main entire panel and can be used as a service disconnect. The branch breakers protect the wires leading to individual electrical loads such as fixtures and outlets.

#### Features, Benefits and Functions

##### Loadcenter Construction

Eaton's Type CH loadcenters feature silver flash plated copper bus in all interiors. Stabs are rated 200 A throughout the CH line. Therefore, the sum of the handle ratings connected to any one stab is limited to 200 A maximum. NEMA 1 boxes are manufactured from cold rolled 16 gauge sheet steel. Raintight boxes are manufactured from galvanized steel. All boxes and trims are finished using an electrostatic powder coat, baked urethane paint process.

##### Neutrals

Eaton Type CH loadcenters feature two types of neutrals:

##### Insulated/Bondable Split Neutral

Panels are supplied with split insulated neutrals with an insulated cross strap. For service entrance applications, the neutral must be bonded by using the bonding strap supplied with the panel. For non-service entrance (sub-panel) applications, the panel may be installed with the bonding strap not connected to the neutral. Separate ground bars must be used on non-service entrance panels.

### Contents

<b>Description</b>	<b>Page</b>
Overview	
Standards and Certifications . . . . .	<b>V1-T1-3</b>
Catalog Number Selection . . . . .	<b>V1-T1-5</b>
Product Selection . . . . .	<b>V1-T1-6</b>
CH Specialty Products . . . . .	<b>V1-T1-13</b>
CH Loadcenter Options and Accessories . . . . .	<b>V1-T1-21</b>
CH Circuit Breakers . . . . .	<b>V1-T1-31</b>

##### Insulated/Bondable Single Neutral

Panels are supplied with a single insulated neutral. For service entrance applications, all that is required to bond the neutral is to loosen the bonding screw and the neutral screw directly beside it, insert the bonding strap into the neutral bar, and re-tighten both connections. The single neutral can be moved by the contractor to the other side of the panel, if desired. When used as a service entrance panel, unused neutral connections may be used for the termination of equipment grounds. For non-service entrance (sub-panel) applications, the panel may be installed with the bonding strap not connected to the neutral. Separate ground bars must be used on non-service entrance panels.

##### Inboard Plug-On Neutral

Code changes and higher safety standards are leading to more arc fault circuit interrupter (AFCI) installations. With the electrical contractor in mind, Eaton has revolutionized the way Combination AFCIs are installed with the Plug-on Neutral line of loadcenters and breakers.

This unique product solution enables the contractor to connect the breaker directly to the neutral bar, eliminating the need for wiring a pigtail.

##### Grounds

In service entrance applications where the neutral is bonded, unused neutral holes may be used for terminating ground conductors. In sub-feed panels, the neutral must be isolated (non-bonded), and ground wires must be terminated on a separate ground bar.

The insulated/bondable single/split neutral panels have sufficient terminations for both ground and neutral conductors. The insulated/bondable single split neutral panels are supplied with a separate factory-installed ground bar if the catalog number contains a "G." If not, a separate ground bar should be installed. Insulated/Bondable Single Neutral panels are supplied without a ground bar (unless otherwise noted), and ground bar kits, if needed, must be purchased separately.

**Neutral and Ground Terminals**

The standard terminals on grounds and neutrals are rated to accept (3)—#14—#10 Cu/Al or (1)—#14—4 wires. For larger cables, add-on neutral lugs may be ordered from the Accessories.

**Note:** NEC® allows only one current carrying conductor per hole on neutrals unless otherwise noted.

**Bottom-Fed Loadcenters**

When the power cable is brought into the loadcenter from below the panel; then the main lug panels, and single-phase, 225 A and below, loadcenters can be rotated 180 degrees to allow straight-in wiring of power cables to the main terminals. Because the CSR main circuit breaker handle operates horizontally, the orientation of the main circuit breaker handle is consistent with the requirements of NEC Article 240.81.

**Gutter Splicing**

Loadcenters are not UL listed as wiring troughs. Therefore, gutter splicing of riser cables to tap off to the main device is not permitted. Refer to NEC Article 373.8.

**Fire Rating**

Due to the numerous openings in both loadcenter boxes and trims, they should not be mounted in firewalls. There is no approval method for sealing the enclosures for this application.

**Date Code**

The date of manufacture of each loadcenter is printed on the outside of the carton as well as inside the loadcenter. On the carton, the date code is printed on the end carton label. In the loadcenter, the date code is located on the small white label located on the right side wall (with the main device on top).

The date code is in the following format: F # # # &. The “F” is the numeric code for the Lincoln, IL plant, and the three numbers are the year and week of manufacture, e.g., 023. The “&” sign at the end signifies the decade of the 2000s. The “!” at the end signifies the decade of the 2010s. Therefore, the date code F023& would indicate that the product was manufactured in the 23rd week of 2000. The 1980s are represented by a “+” sign and the 1990s are represented by a “=” at the end of the code.

**Plug-On Type CH Breakers**

Quick-make, quick-break switch mechanism combined with inverse time element tripping operation and trip-free handle design. Type CH circuit breakers trip to the OFF position eliminating nuisance callbacks. The thermal-magnetic trip curve avoids nuisance tripping on mild overloads while reacting almost instantaneously to severe short-circuit conditions. CHF breakers include a ‘trip flag’ to differentiate between a tripped breaker and one that has been turned off. Multipole breakers have internal common trip connection to operate all poles simultaneously. Handles are marked with ON-OFF indication and ampere rating of the breaker. Type CH breakers meet UL Standard 489, NEMA standards, and Federal Spec Classification W-C 375 b/Gen. They are UL listed under File Number E11713, E8741, E3624 and E51287; and CSA® certified file number LR87196, except Type CHT breakers.

**Type CH Circuit Breaker Ratings**

Single- and double-pole CH breakers rated 15 and 20 A have low instantaneous magnetic trip levels. The 15 and 20 A breakers with “HM” suffix have high magnetic trip settings recommended for circuits with inherently high inrush currents. All Type CH breakers are marked for heating, air conditioning and refrigeration (HACR) equipment application. Single-pole 15–20 A breakers are also suitable for switching duty (SWD). Shunt trip coils operate on 120 Vac and require one additional pole space per breaker.

**Standards and Certifications****UL® Listings**

All Eaton Type CH loadcenters are listed under the UL 67 certification in file E8741.



# 1.1

## Loadcenters and Circuit Breakers

### Type CH Loadcenters and Circuit Breakers

1

#### Type CH Loadcenter

Extra 1.5 inch Knockout (38.1 mm)

- Larger knockout provides easier installation and time savings for renovation installations

Top or Bottom Feed

- Straight-in wiring saves labor and material
- One panel for either top or bottom applications

2/0 Lug

- Easily removable and can be installed in any location on the neutral bar

Commercial Grade Main Breaker

- 25 kAIC series rated main breaker in 150 A–225 A loadcenters. 35, 42 and 100 kAIC series ratings are available
- Optional convertible design—reduces inventory requirements

One Piece Silver-Flashed Copper Bus

- Provides superior conductivity, corrosion resistance and durability

Drywall Marking on Enclosure

- Indicates proper mounting depth for flush applications

Steel Backpan

- Provides solid and reliable breaker mounting—single piece design for stability and durability

“Tangential” Center Knockout

- Easier installation for conduit applications

Unique Sandalwood Finish

- Aesthetically appealing, scratch-resistant powder coating

Neutral Bus (Strap)

- Easily removable for sub-panel applications

Bonding Z-Strap

- Provides easy field conversion for service entrance applications

Twin Neutral Bars

- Minimum 150% neutral capacity

Type CHF AFCI/GFCI/Thermal-Magnetic Breakers

- Advanced electronics effectively reduce nuisance tripping
- CHF AFCI breakers have a standard diagnostic LED indicating 1 of 7 trip codes
- Mechanical flag for trip indication (on thermal-magnetic AFCI and GFCI)
- All CH breakers provide industry exclusive 2-position handle with simple 1 step reset

Single Keyhole Mounting

- One keyhole at the top and bottom provides easier mounting and leveling

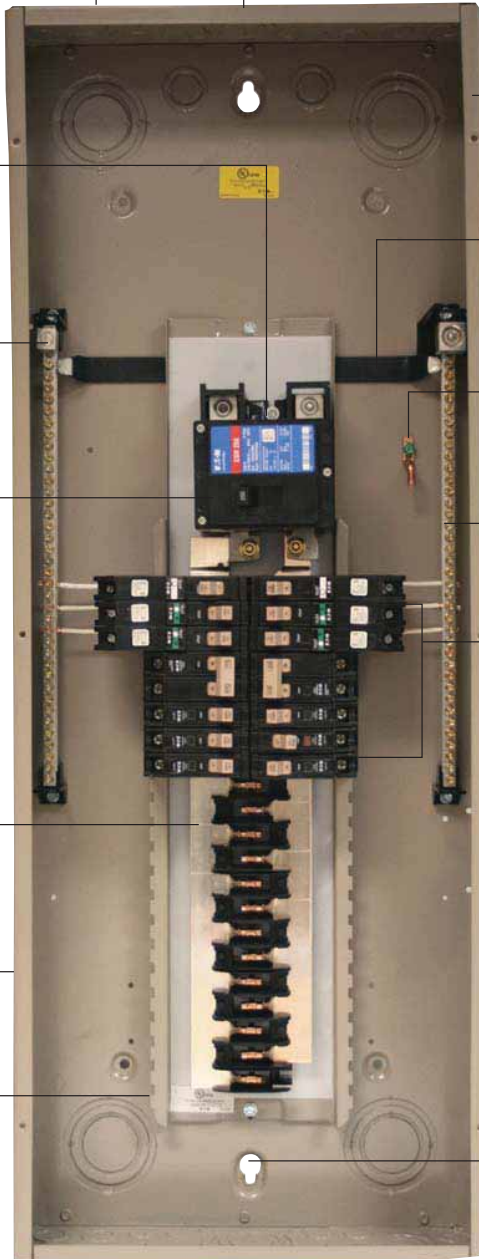

#### Warranty

The minimum warranty for residential loadcenters, breakers and surge protection devices shall be as follows:

- Lifetime loadcenter warranty
- Lifetime warranty on CH circuit breakers
- Lifetime warranty on CHSPT2ULTRA including \$75,000 connected equipment warranty
- 1-year warranty on plug-in surge protective device (CHSA)

### Catalog Number Selection

#### Loadcenters 100–225 A and 12–42 Circuits

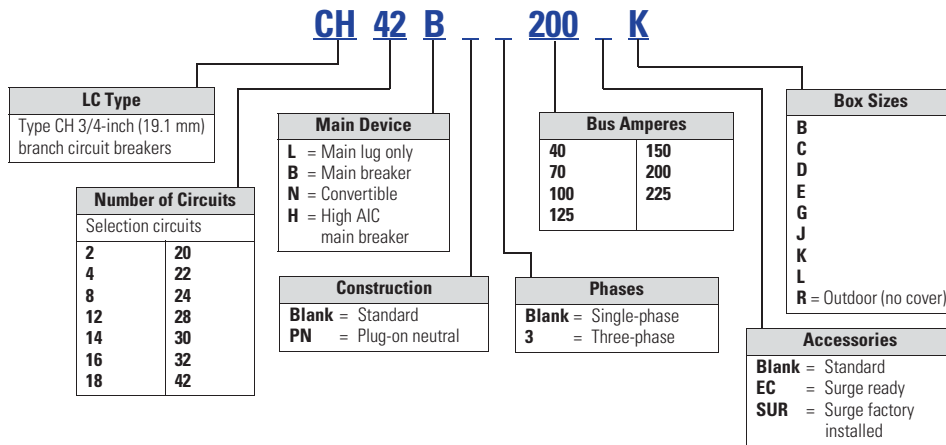

#### Indoor Covers Ordered Separately

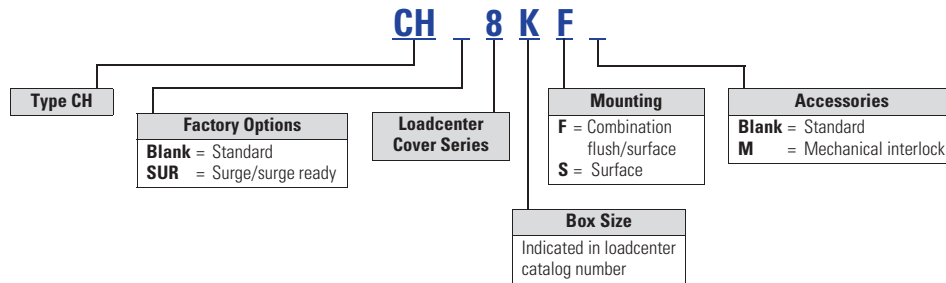

**Note:** All combinations are not valid, refer to the catalog section.

# 1.1

## Loadcenters and Circuit Breakers

### Type CH Loadcenters and Circuit Breakers

#### 1

#### Product Selection

#### Single-Phase—Main Circuit Breaker Loadcenters—10/25 kAIC

CH42B200K



#### Single-Phase Three-Wire—120/240 Vac—Insulated/Bondable Split Neutral (Unless Otherwise Noted)

Main Breaker Type	Main Ampere Rating	Maximum Number 3/4-Inch (19.1 mm) of Poles	Enclosure Type	Box Size	Wire Size Range Cu/Al 60 °C or 75 °C for Main Breaker	Loadcenter <sup>①②</sup> Catalog Number	Loadcenter Cover Catalog Number	Combination <sup>③</sup>	Surface	
CH 10 kAIC	100	14	Indoor	B	#6–1/0	CH14B100B <sup>④</sup>	CH8BF	CH8BS		
		14	Outdoor	B	#6–1/0	CH14B100R <sup>⑤</sup>	—	—		
		18	Indoor	C	#6–1/0	CH18B100C <sup>④</sup>	CH8CF	CH8CS		
		18	Outdoor	C	#6–1/0	CH18B100R <sup>⑤</sup>	—	—		
		22	Indoor	C	#6–1/0	CH22B100C <sup>④</sup>	CH8CF	CH8CS		
		22	Outdoor	C	#6–1/0	CH22B100R <sup>⑤</sup>	—	—		
		30	Indoor	D	#6–1/0	CH30B100D <sup>④</sup>	CH8DF	CH8DS		
		30	Outdoor	D	#6–1/0	CH30B100R <sup>⑤</sup>	—	—		
	125	22	Indoor	C	#6–1/0	CH22B125C <sup>④</sup>	CH8CF	CH8CS		
		22	Outdoor	C	#6–1/0	CH22B125R <sup>⑤</sup>	—	—		
		30	Indoor	D	#6–1/0	CH30B125D <sup>④</sup>	CH8DF	CH8DS		
		30	Outdoor	D	#6–1/0	CH30B125R <sup>⑤</sup>	—	—		
		CSR 25 kAIC	150	8	Outdoor	E	#2–300 kcmil	CH8B150RF <sup>⑥</sup>	—	—
				24	Indoor	E	#2–300 kcmil	CH24B150E <sup>④</sup>	CH8EF	CH8ES
24	Outdoor			E	#2–300 kcmil	CH24B150R <sup>⑤</sup>	—	—		
32	Indoor			J	#2–300 kcmil	CH32B150J <sup>④</sup>	CH8JF	CH8JS		
32	Outdoor			J	#2–300 kcmil	CH32B150R <sup>⑤</sup>	—	—		
200	8		Outdoor	E	#2–300 kcmil	CH8B200RF <sup>⑥</sup>	—	—		
	24		Indoor	E	#2–300 kcmil	CH24B200E <sup>④</sup>	CH8EF	CH8ES		
	24		Outdoor	E	#2–300 kcmil	CH24B200R <sup>⑤</sup>	—	—		
	32		Indoor	J	#2–300 kcmil	CH32B200J <sup>④</sup>	CH8JF	CH8JS		
	32		Outdoor	J	#2–300 kcmil	CH32B200R <sup>⑤</sup>	—	—		
225	42	Indoor	K	#2–300 kcmil	CH42B200K <sup>④</sup>	CH8KF	CH8KS			
	42	Outdoor	K	#2–300 kcmil	CH42B200R <sup>⑤</sup>	—	—			
	32	Indoor	J	#2–300 kcmil	CH32B225J <sup>④</sup>	CH8JF	CH8JS			
	32	Outdoor	J	#2–300 kcmil	CH32B225R <sup>⑤</sup>	—	—			
DK 10 kAIC	300	42	Indoor	PM	(2) 3/0–250 kcmil	CH42PM300	CH7PMF <sup>⑦</sup>	CH7PMS		
		42	Indoor	PM	(2) 3/0–250 kcmil	CH42PM400	CH7PMF <sup>⑦</sup>	CH7PMS		
	400	42	Indoor	PM	(2) 3/0–250 kcmil	CH42PM300	CH7PMF <sup>⑦</sup>	CH7PMS		
		42	Indoor	PM	(2) 3/0–250 kcmil	CH42PM400	CH7PMF <sup>⑦</sup>	CH7PMS		

#### Notes

- ① All main circuit breaker loadcenters are listed for use as service entrance equipment.
- ② Ground bar kits priced separately. See **Page V1-T1-24**.
- ③ Combination style covers may be used in surface or flush applications.
- ④ Can be top or bottom fed by rotating the enclosure and trim 180 degrees.
- ⑤ Rainproof panels are furnished with hub closure plates. For rainproof hubs, refer to **Page V1-T1-24**.
- ⑥ Panel includes #4–300 kcmil feed-through lugs.
- ⑦ This cover is for flush applications only (not combination).

Box sizes **Pages V1-T1-29** and **V1-T1-30**.

### Single-Phase—High Interrupting Rated Main Circuit Breaker Loadcenters—100 kAIC

#### Single-Phase Three-Wire—120/240 Vac—Insulated/Bondable Split Neutral

Main Breaker Type	Main Ampere Rating	Maximum Number 3/4-Inch (19.1 mm) Poles	Enclosure Type	Box Size	Wire Size Range Cu/Al 60 °C or 75 °C for Main Breaker	Loadcenter <sup>①</sup> Catalog Number	Loadcenter Cover Catalog Number Combination <sup>②</sup>	Surface
CHB4 100 kAIC <sup>⑤</sup>	100	32	Indoor	L	#6–1/0	CH32H100L <sup>③</sup>	CH8LF	CH8LS
		32	Outdoor	L	#6–1/0	CH32H100R <sup>④</sup>	—	—
CHH 100 kAIC <sup>⑤</sup>	150	32	Indoor	L	#2/0–300 kcmil	CH32H150L	CH8LF	CH8LS
		32	Outdoor	L	#2/0–300 kcmil	CH32H150R <sup>④</sup>	—	—
	200	32	Indoor	L	#2/0–300 kcmil	CH32H200L	CH8LF	CH8LS
		32	Outdoor	L	#2/0–300 kcmil	CH32H200R <sup>④</sup>	—	—
		42	Indoor	L	#2/0–300 kcmil	CH42H200L	CH8LF	CH8LS
		42	Outdoor	L	#2/0–300 kcmil	CH42H200R <sup>④</sup>	—	—
	225	42	Indoor	L	#2/0–300 kcmil	CH42H225L	CH8LF	CH8LS
		42	Outdoor	L	#2/0–300 kcmil	CH42H225R <sup>④</sup>	—	—

#### Notes

- ① All main circuit breaker loadcenters are listed for use as service entrance equipment.
- ② Combination style covers may be used in surface or flush applications.
- ③ Loadcenter can be top or bottom fed by rotating the enclosure and trim 180 degrees.
- ④ Rainproof panels are furnished with hub closure plates. For rainproof hubs, refer to **Page V1-T1-24**.
- ⑤ Series rated for 100 kAIC with all Types CH, CHT and CHP breakers.



# 1.1





## Loadcenters and Circuit Breakers

### Type CH Loadcenters and Circuit Breakers

1

#### Single-Phase—Main Lug Loadcenters

#### Single-Phase Three-Wire—120/240 Vac—Insulated/Bondable Single Neutral

Main Ampere Rating	Maximum Number 3/4-Inch (19.1 mm)		Enclosure Type	Type of Trim (Included)	Box Size	Wire Size Range Cu/Al 60 °C or 75 °C for Main Lugs	Loadcenter Catalog Number
	Space	Poles					
<b>Surface Outdoor</b> 	2	4 ①	Indoor	Surface (no door)	5	#14–6	<b>CH2L40SP</b> ②③
	2	4 ①	Outdoor	—	5R	#14–6	<b>CH2L40RP</b> ②③④
	2	4 ①	Indoor	Flush (no door)	5	#14–6	<b>CH2L40FP</b> ②③
<b>Flush Outdoor</b> 	2	4 ①	Indoor	Surface (no door)	5	#14–2	<b>CH2L70SP</b> ②③
	2	4 ①	Outdoor	—	5R	#14–2	<b>CH2L70RP</b> ②③④
	2	4 ①	Indoor	Flush (no door)	5	#14–2	<b>CH2L70FP</b> ②③
<b>Surface (No Door)</b> 	2	4 ①	Indoor	Surface (no door)	6	#14–1/0	<b>CH2L125SP</b> ②③
	2	4 ①	Outdoor	—	6R	#14–1/0	<b>CH2L125RP</b> ②③④
	2	2	Outdoor	—	—	#14–1/0	<b>CH2L125RSE2P</b> ④⑤⑥
	2	4 ①	Indoor	Flush (no door)	6	#14–1/0	<b>CH2L125FP</b> ②③
	4	8 ①	Indoor	Surface (no door)	7	#14–1/0	<b>CH4L125SP</b> ②⑦
	4	8 ①	Outdoor	—	7R	#14–1/0	<b>CH4L125RP</b> ②④⑦
	4	8 ①	Indoor	Flush (no door)	7	#14–1/0	<b>CH4L125FP</b> ②⑦
	6	12 ①	Outdoor	—	6R	#14–1/0	<b>CH6L125R</b> ②⑥⑦
	8	16 ①	Indoor	Surface (no door)	7	#6–1/0	<b>CH8L125SP</b> ②⑧
	8	16 ①	Outdoor	—	7R	#6–1/0	<b>CH8L125RP</b> ②⑥⑦
<b>Flush (No Door)</b> 	8	16 ①	Indoor	Surface (no door)	7	#6–1/0	<b>CH8L125SP</b> ②⑧
	8	16 ①	Outdoor	—	7R	#6–1/0	<b>CH8L125RP</b> ②⑥⑦
<b>Outdoor</b> 	8	16 ①	Indoor	Flush (no door)	7	#6–1/0	<b>CH8L125FP</b> ②⑥

#### Notes

- ① Requires the use of Type CHT breakers.
- ② Ground bar kits priced separately, see **Page V1-T1-24**.
  - For 2/4 and 6/12 circuit loadcenters, use Type GBK5 or GBK520 ground bar
  - For 4/8 and 8/16 circuit loadcenters, use Type GBK10 ground bar
  - Ground bars mount to the left side wall of the enclosure for the 4/8, 6/12 and 8/16 circuit loadcenters
- ③ Suitable for use as service equipment when not more than two service disconnecting mains are provided or when not used as a lighting and appliance panelboard.
- ④ Rainproof panels are furnished with hub closure plates. For rainproof hubs, refer to **Page V1-T1-24**.
- ⑤ For use as service entrance applications only.
- ⑥ Neutral/ground holes (6) #14–6 and (3) #14–2/0 AWG Cu/Al.
- ⑦ Suitable for use as service equipment when not more than two service disconnecting mains are provided or when not more than six service disconnecting mains are provided and when not used as a lighting and appliance panelboard.
- ⑧ Suitable for use as service equipment when a main breaker is used or when not more than six service disconnecting mains are provided and when not used as a lighting and appliance panelboard.

Box sizes **Pages V1-T1-29 and V1-T1-30**.

CH42L225G



### Single-Phase Three-Wire—120/240 Vac—Insulated/Bondable Split Neutral—Factory-Installed Ground Bar

Main Ampere Rating	Maximum Number 3/4-Inch (19.1 mm) Poles	Enclosure Type	Box Size	Wire Size Range Cu/Al 60 °C or 75 °C for Main Lugs	Loadcenter Catalog Number	Loadcenter Cover	
						Catalog Number Combination	Surface
125	12	Indoor	B	#6–2/0	CH12L125B ①	CH8BF	CH8BS
	12	Outdoor	B	#6–2/0	CH12L125R ①②	—	—
	16	Indoor	B	#6–2/0	CH16L125B ①	CH8BF	CH8BS
	16	Outdoor	B	#6–2/0	CH16L125R ①②	—	—
	20	Indoor	C	#6–2/0	CH20L125C ①	CH8CF	CH8CS
	20	Outdoor	C	#6–2/0	CH20L125R ①②	—	—
	24	Indoor	C	#6–2/0	CH24L125C ①	CH8CF	CH8CS
	24	Outdoor	C	#6–2/0	CH24L125R ①②	—	—
150	24	Indoor	D	#4–300 kcmil	CH24L150D ①	CH8DF	CH8DS
	24	Outdoor	D	#4–300 kcmil	CH24L150R ②③	—	—
	32	Indoor	D	#4–300 kcmil	CH32L150D ①	CH8DF	CH8DS
	32	Outdoor	D	#4–300 kcmil	CH32L150R ②③	—	—
200	12	Indoor	D	#4–300 kcmil	CH12L200D ①	CH8DF	CH8DS
	12	Outdoor	D	#4–300 kcmil	CH12L200R ②③	—	—
	16	Indoor	D	#4–300 kcmil	CH16L200D ①	CH8DF	CH8DS
	16	Outdoor	D	#4–300 kcmil	CH16L200R ②③	—	—
225	24	Indoor	D	#4–300 kcmil	CH24L225D ①	CH8DF	CH8DS
	24	Outdoor	D	#4–300 kcmil	CH24L225R ②③	—	—
	32	Indoor	D	#4–300 kcmil	CH32L225D ①	CH8DF	CH8DS
	32	Outdoor	D	#4–300 kcmil	CH32L225R ②③	—	—
	42	Indoor	G	#4–300 kcmil	CH42L225G ③	CH8GF	CH8GS
	42	Outdoor	G	#4–300 kcmil	CH42L225R ②③	—	—
400	42	Indoor	P	(2) 1/0–300 kcmil (1) 750 kcmil	CH42PL400 ④	CH7PF ⑤	CH7PS

**Notes**

- ① Suitable for use as service equipment when not more than six disconnecting means are provided and when not used as a lighting and appliance panelboard.
- ② Rainproof panels are furnished with hub closure plates. For rainproof hubs, refer to **Page V1-T1-24**.
- ③ Suitable for use as service equipment when a circuit breaker is used as a main breaker. The main breaker is backfed and requires hold-down bracket kit catalog number **CH125RB**.
- ④ Suitable for use as service equipment when a circuit breaker is used as a main breaker. The main breaker is backfed and must be a Type CHB.  
**The breaker cannot be a Type CH.**
- ⑤ This cover is for flush application only (not combination).

Box sizes **Pages V1-T1-29** and **V1-T1-30**.

# 1.1

## Loadcenters and Circuit Breakers

### Type CH Loadcenters and Circuit Breakers

1

#### Convertible Loadcenters MCB or MLO—Base Units and Main Devices—10/25/35 kAIC

Complete assembly consists of: loadcenter, cover, and either main breaker kit or main lug kit.

#### Indoor—Single-Phase—Three-Wire—120/240 V—Insulated/Bondable Split Neutral—Top or Bottom Feed

Maximum Main Ampere Rating	Maximum Number of Single Poles	Box Size	Loadcenter Box and Panel Catalog Number ①	Loadcenter Cover Catalog Number		Main Lug Kit		Main Breaker Kit		Catalog Number	
				Combination	Surface	Wire Size	Catalog Number	kAIC Rating	Wire Size		
125	22	C	CH22N125C	CH8CF	CH8CS	#10–1/0	CHL125N	10	#10–1/0	CH2100N ③	—
										CH2125N ③	—
200	32	J	CH32N200J	CH8JF	CH8JS	#4–300 kcmil	CHL225N	25/35 ②	#2–300 kcmil	CSR2125N	CSH2125N ④
										CSR2150N	CSH2150N ④
										CSR2175N	CSH2175N ④
										CSR2200N	CSH2200N ④
225	42	K	CH42N225K	CH8KF	CH8KS	#4–300 kcmil	CHL225N	25/35 ②	#2–300 kcmil	CSR2125N	CSH2125N ④
										CSR2150N	CSH2150N ④
										CSR2175N	CSH2175N ④
										CSR2200N	CSH2200N ④
										CSR2225N	CSH2225N ④

#### Outdoor—Single-Phase—Three-Wire—120/240 V—Insulated/Bondable Split Neutral (Unless Otherwise Noted)

Maximum Main Ampere Rating	Maximum Number of Single Poles	Box Size	Loadcenter Box and Panel Catalog Number ①	Main Lug Kit		Main Breaker Kit		Catalog Number	
				Wire Size	Catalog Number	kAIC Rating	Wire Size		
125	22	C	CH22N125R ⑤	#10–1/0	CHL125N	10	#10–1/0	CH2100N ③	—
								CH2125N ③	—
200	8	E	CH8N200RF ⑥⑦	#4–300 kcmil	CHL225N	25/35 ②	#2–300 kcmil	CSR2125N	CSH2125N
								CSR2150N	CSH2150N
								CSR2175N	CSH2175N
								CSR2200N	CSH2200N
200	32	J	CH32N200R ⑤	#4–300 kcmil	CHL225N	25/35 ②	#2–300 kcmil	CSR2125N	CSH2125N ④
								CSR2150N	CSH2150N ④
								CSR2175N	CSH2175N ④
								CSR2200N	CSH2200N ④
225	42	K	CH42N225R ⑤	#4–300 kcmil	CHL225N	25/35 ②	#2–300 kcmil	CSR2125N	CSH2125N ④
								CSR2150N	CSH2150N ④
								CSR2175N	CSH2175N ④
								CSR2200N	CSH2200N ④
								CSR2225N	CSH2225N ④

#### Notes

- ① Panel does not include main. Order main breaker or main lug kit separately.
- ② If 35 kAIC is required, use CSH breaker.
- ③ Hold-down kit included.
- ④ 35 kAIC series combination rating is obtained when Types CH, CHT and CHP branch breakers are used with CSH main.
- ⑤ Rainproof panels are furnished with hub closure plates. For rainproof hubs, refer to **Page V1-T1-24**.
- ⑥ Includes feed-through lugs for both phase and neutral conductors.
- ⑦ Insulated/bondable single neutral.

Interrupting rating depends on main circuit breaker selected.

### Three-Phase—Main Circuit Breaker Loadcenters—10 kAIC

CH42B3200L



#### Three-Phase Four-Wire—208Y/120 Vac or 240 Vac Insulated/Bondable Split Neutral

Main Breaker Type	Main Ampere Rating	Maximum Number 3/4-Inch (19.1 mm) Poles	Enclosure Type	Box Size	Wire Size Range Cu/Al 60 °C or 75 °C for Main Breaker	Loadcenter Catalog Number <sup>①②</sup>	Loadcenter Cover Catalog Number	
							Combination	Surface
CC 10 kAIC	150	30	Indoor	L	#1–4/0	CH30B3150L	CH8LF	CH8LS
			Outdoor	L	#1–4/0	CH30B3150R <sup>③</sup>	—	—
	200	30	Indoor	L	#2/0–300 kcmil	CH30B3200L	CH8LF	CH8LS
			Outdoor	L	#2/0–300 kcmil	CH30B3200R <sup>③</sup>	—	—
		42	Indoor	L	#2/0–300 kcmil	CH42B3200L	CH8LF	CH8LS
			Outdoor	L	#2/0–300 kcmil	CH42B3200R <sup>③</sup>	—	—
	225	30	Indoor	L	#2/0–300 kcmil	CH30B3225L	CH8LF	CH8LS
			Outdoor	L	#2/0–300 kcmil	CH30B3225R <sup>③</sup>	—	—
		42	Indoor	L	#2/0–300 kcmil	CH42B3225L	CH8LF	CH8LS
			Outdoor	L	#2/0–300 kcmil	CH42B3225R <sup>③</sup>	—	—
	400	42	Indoor	PM	(2) 3/0–350 kcmil	CH424PM400	CH7PMF <sup>④</sup>	CH7PMS

### Three-Phase—High Interrupting Rated Main Circuit Breaker Loadcenters—100 kAIC

#### Three-Phase Four-Wire—208Y/120 Vac or 240 Vac Insulated/Bondable Split Neutral

Main Breaker Type	Main Ampere Rating	Maximum Number 3/4-Inch (19.1 mm) of Poles	Enclosure Type	Box Size	Wire Size Range Cu/Al 60 °C or 75 °C for Main Breaker	Loadcenter Catalog Number <sup>①②</sup>	Loadcenter Cover Catalog Number	
							Combination	Surface
CHH 100 kAIC <sup>⑤</sup>	200	30	Indoor	L	#2/0–300 kcmil	CH30H3200L	CH8LF	CH8LS
			Outdoor	L	#2/0–300 kcmil	CH30H3200R <sup>③</sup>	—	—
		42	Indoor	L	#2/0–300 kcmil	CH42H3200L	CH8LF	CH8LS
			Outdoor	L	#2/0–300 kcmil	CH42H3200R <sup>③</sup>	—	—
	225	42	Indoor	L	#2/0–300 kcmil	CH42H3225L	CH8LF	CH8LS
			Outdoor	L	#2/0–300 kcmil	CH42H3225R <sup>③</sup>	—	—

#### Notes

- ① All main circuit breaker loadcenters are listed for use as service entrance equipment.
- ② Ground bar kits priced separately. For ground bar kits, see **Page V1-T1-24**.
- ③ Rainproof loadcenters are furnished with hub closure plates. For rainproof hubs, refer to **Page V1-T1-24**.
- ④ This cover for flush application only (not combination).
- ⑤ 100 kAIC series combination rating is obtained when Types CH and CHP branch breakers are used with CHH main.

# 1.1

## Loadcenters and Circuit Breakers

### Type CH Loadcenters and Circuit Breakers

1

#### Three-Phase—Main Lug Loadcenters

#### Three-Phase Four-Wire—208Y/120 Vac or 240 Vac Insulated/Bondable Split Neutral (Unless Otherwise Noted)

Main Ampere Rating	Maximum Number 3/4-Inch (19.1 mm)		Enclosure Type	Type of Trim Included	Box Size	Wire Size Range Cu/Al 60 °C or 75 °C for Main Lugs	Loadcenter Catalog Number	Loadcenter Cover Catalog Number	
	Spaces	Poles						Combination	Single
125	6	12 <sup>①</sup>	Indoor	Surface, no door	7	#14–1/0	CH6L3125SP <sup>②③④</sup>	—	—
	6	12 <sup>①</sup>	Outdoor	—	7R	#14–1/0	CH6L3125RP <sup>②③④⑤</sup>	—	—
	6	12 <sup>①</sup>	Indoor	Flush, no door	7	#14–1/0	CH6L3125FP <sup>②③④</sup>	—	—
	12	12	Indoor	—	B	#6–2/0	CH12L3125B <sup>⑥⑦</sup>	CH8BF	CH8BS
	12	12	Outdoor	—	B	#6–2/0	CH12L3125R <sup>⑥⑥⑦</sup>	—	—
	18	18	Indoor	—	C	#6–2/0	CH18L3125C <sup>⑥⑦</sup>	CH8CF	CH8CS
	18	18	Outdoor	—	C	#6–2/0	CH18L3125R <sup>⑥⑦⑧</sup>	—	—
	24	24	Indoor	—	C	#6–2/0	CH24L3125C <sup>⑥⑦</sup>	CH8CF	CH8CS
150	30	30	Indoor	—	D	#4–300 kcmil	CH30L3150D <sup>⑥⑦</sup>	CH8DF	CH8DS
	30	30	Outdoor	—	D	#4–300 kcmil	CH30L3150R <sup>⑥⑥⑨</sup>	—	—
225	24	24	Indoor	—	D	#4–300 kcmil	CH24L3225D <sup>⑥⑦</sup>	CH8DF	CH8DS
	24	24	Outdoor	—	D	#4–300 kcmil	CH24L3225R <sup>⑥⑥⑨</sup>	—	—
	30	30	Indoor	—	D	#4–300 kcmil	CH30L3225D <sup>⑥⑦</sup>	CH8DF	CH8DS
	30	30	Outdoor	—	D	#4–300 kcmil	CH30L3225R <sup>⑥⑥⑨</sup>	—	—
	42	42	Indoor	—	G	#4–300 kcmil	CH42L3225G <sup>⑥⑨</sup>	CH8GF	CH8GS
	42	42	Outdoor	—	G	#4–300 kcmil	CH42L3225R <sup>⑥⑥⑨</sup>	—	—
400	42	42	Indoor	—	P	(2) 1/0–300 kcmil (1) 750 kcmil	CH424PL400 <sup>⑩⑪</sup>	CH7PF <sup>Ⓜ</sup>	CH7PS

#### Notes

- ① Requires the use of Type CHT breakers.
- ② Suitable for use as service equipment when not more than two service disconnecting means are provided or when not more than six service disconnecting means are provided and when not used as a lighting and appliance panelboard.
- ③ Ground bar kits priced separately, see **Page V1-T1-24**.  
– Use GBK10 ground bar  
– Ground bars mount to the left side wall of the enclosure.
- ④ Insulated/bondable single neutral.
- ⑤ Rainproof loadcenters are furnished with hub closure plates. For rainproof hubs, refer to **Page V1-T1-24**.
- ⑥ Ground bar Type GBK14 is installed.
- ⑦ Suitable for use as service equipment when a circuit breaker is used as a main breaker. The main breaker is backfed and requires hold-down bracket kit catalog number Type **CH125RB**. Suitable for use as service equipment when not more than six service disconnecting means are provided and when not used as a lighting and appliance panelboard.
- ⑧ Ground bar Type GBK21 is installed.
- ⑨ Suitable for use as service equipment when a circuit breaker is used as a main breaker. The main breaker is backfed and requires hold-down kit catalog number Type **CH125RB**.
- ⑩ For ground bar kits, see **Page V1-T1-24**.
- ⑪ Suitable for use as service equipment when a circuit breaker is used as a main breaker. The main breaker is backfed and must be a Type CHB.  
**The breaker cannot be a Type CH.**
- Ⓜ This cover for flush application only (not combination).

Box sizes **Pages V1-T1-29** and **V1-T1-30**.

### Spa Panels



### Contents

Description	Page
Overview	V1-T1-2
CH Specialty Products	
Spa Panels	
Surge Panel	V1-T1-14
Plug-On Neutral Loadcenter	V1-T1-16
Type CH Renovation Loadcenter	V1-T1-17
Type CH Retrofit Interior Kits	V1-T1-18
CH Loadcenter Options and Accessories	V1-T1-21
CH Circuit Breakers	V1-T1-31

## CH Specialty Products

### Spa Panels

#### Product Description

Eaton's CH Spa Panels are premium factory-assembled "combination" units that provide ground fault protection, as well as a convenient way to turn spa pumps on and off. The NEC requires that all pool and spa pumps be protected by a ground fault interrupter and a disconnect switch mounted within 10 feet of the tub or the spa.

#### Features

- Two extra circuits for additional loads
- Limited lifetime warranty
- UL Listed
- Tough powder-coated galvanized steel enclosure
- Factory-installed two-pole ground fault circuit interrupter (GFCI)

#### Product Selection

##### CH Spa Panel



#### Single-Phase Three-Wire—120/240 Vac Insulated/Bondable Neutral—Factory-Installed Ground Bar

Main Ampere Rating	Circuit Breaker Included	Enclosure Type	Type of Trim Included	Box Size	Wire Size Range Cu/Al 60 °C or 75 °C for Main Lugs	Catalog Number
30	CH230GFT	Outdoor	—	5R	#14–1/0	CH30SPAST <sup>①</sup>
40	CH240GFT	Outdoor	—	5R	#14–1/0	CH40SPAST <sup>②</sup>
50	CH250GFT	Outdoor	—	5R	#14–1/0	CH50SPAST <sup>③</sup>
60	CH260GFT	Outdoor	—	5R	#14–1/0	CH60SPAST <sup>④</sup>

#### Notes

- ① Includes a CH230GFT breaker, factory installed, and two extra circuits for convenience.
- ② Includes a CH240GFT breaker, factory installed, and two extra circuits for convenience.
- ③ Includes a CH250GFT breaker, factory installed, and two extra circuits for convenience.
- ④ Includes a CH260GFT breaker, factory installed, and two extra circuits for convenience.

Surge Panel



### Surge Panel

#### Product Description

Eaton's Type CH Surge Loadcenter includes a factory-mounted and wired surge suppressor device. There is a knockout in the cover that allows the user to view the status indication lights on the surge suppressor. The CH Surge Loadcenter reduces the surge current, helping protect sensitive home electronic equipment.

Save labor by installing a factory-mounted surge protective device.

#### Factory-Installed Surge Protection

- Includes a CHSPT2ULTRA and a two-pole 50 A circuit breaker
- Increases the effectiveness of surge protection due to reduced lead length
- A modified deadfront allows for easy viewing of indicating lights

#### Surge Ready

- Provides a mounting provision for CHSPT2ULTRA
- A modified deadfront allows for easy viewing of indicating lights

#### Product Selection

##### Surge Installed Loadcenters

Ampere Rating	Type	Number of Circuits	Loadcenter Catalog Number	Loadcenter Cover	
				Catalog Number	Surface
225	Convertible	42	CHSUR42N225L ①	CHSUR8LF	CHSUR8LS
225	Convertible ②	42	CHSUR42L225L2 ①	CHSUR8LF	CHSUR8LS
200	Main breaker	42	CHSUR42B200L2 ①	CHSUR8LF	CHSUR8LS
225	Convertible	32	CHSUR32N225K ①	CHSUR8KF	CHSUR8KS
225	Convertible ②	32	CHSUR32L225K ①	CHSUR8KF	CHSUR8KS
200	Main breaker	32	CHSUR32B200K ①	CHSUR8KF	CHSUR8KS
150	Main breaker	32	CHSUR32B150K ①	CHSUR8KF	CHSUR8KS
100	Main breaker	32	CHSUR32B100K ①	CHSUR8KF	CHSUR8KS
125	Convertible ②	24	CHSUR24L125E ①	CHSUR8EF	CHSUR8ES
100	Main breaker	24	CHSUR24B100E ①	CHSUR8EF	CHSUR8ES
200	Convertible	40/40	BRSUR4040N200	Cover included	
200	Main lug	40/40	BRSUR4040L200	Cover included	
200	Main breaker	40/40	BRSUR4040B200	Cover included	
200	Convertible	30/40	BRSUR3040N200	Cover included	
200	Main lug	30/40	BRSUR3040L200	Cover included	
200	Main breaker	30/40	BRSUR3040B200	Cover included	

#### Notes

- ① Order cover separately.
- ② With main lugs installed.

### Contents

Description	Page
Overview	V1-T1-2
CH Specialty Products	
Spa Panels	V1-T1-13
Surge Panel	
Plug-On Neutral Loadcenter	V1-T1-16
Type CH Renovation Loadcenter	V1-T1-17
Type CH Retrofit Interior Kits	V1-T1-18
CH Loadcenter Options and Accessories	V1-T1-21
CH Circuit Breakers	V1-T1-31

### Surge Ready Loadcenters (provision only, CHSPT2ULTRA and breaker not included)

Ampere Rating	Type	Number of Circuits	Loadcenter Catalog Number <sup>①</sup>	Loadcenter Cover Catalog Number Combination	Loadcenter Cover Catalog Number Surface
225	Convertible	42	CHEC42N225L	CHSUR8LF	CHSUR8LS
225	Convertible <sup>②</sup>	42	CHEC42L225L	CHSUR8LF	CHSUR8LS
200	Main breaker	42	CHEC42B200L	CHSUR8LF	CHSUR8LS
225	Convertible <sup>②</sup>	32	CHEC32L225K	CHSUR8KF	CHSUR8KS
225	Convertible	32	CHEC32N225K	CHSUR8KF	CHSUR8KS
225	Convertible	32	CHEC32N225R <sup>③</sup>	—	—
200	Main breaker	32	CHEC32B200K	CHSUR8KF	CHSUR8KS
150	Main breaker	32	CHEC32B150K	CHSUR8KF	CHSUR8KS
100	Main breaker	32	CHEC32B100K	CHSUR8KF	CHSUR8KS
125	Convertible <sup>②</sup>	24	CHEC24L125E	CHSUR8EF	CHSUR8ES
100	Main breaker	24	CHEC24B100E	CHSUR8EF	CHSUR8ES

### Technical Data and Specifications

#### Ratings

- Loadcenter
  - 25 kAIC main breaker, main lug only, and convertible main breaker/main lug
  - Factory installed or provision for field-installed surge suppressor
  - Top or bottom feed
- Surge protective device (CHSPT2ULTRA)
  - Nominal discharge current: 20 kA ( $I_n$ )
  - Surge current capacity per phase: 108 kA
  - Warranty: \$75,000 connected equipment <sup>④</sup>
  - For further product ratings, see Volume 1, Tab 2.1 Surge Protection

#### Notes

- ① Order cover separately.
- ② With main lugs installed.
- ③ Rainproof loadcenters are furnished with hub closure plates. For rainproof hubs, refer to **Page V1-T1-24**.
- ④ For warranty details, visit [www.eaton.com/surgetrap](http://www.eaton.com/surgetrap).



#### 60-Circuit Plug-On Neutral Loadcenter



### Contents

<i>Description</i>	<i>Page</i>
Overview .....	V1-T1-2
CH Specialty Products	
Spa Panels .....	V1-T1-13
Surge Panel .....	V1-T1-14
Plug-On Neutral Loadcenter	
Type CH Renovation Loadcenter .....	V1-T1-17
Type CH Retrofit Interior Kits .....	V1-T1-18
CH Loadcenter Options and Accessories .....	V1-T1-21
CH Circuit Breakers .....	V1-T1-31

### Plug-On Neutral Loadcenter

#### Product Description

Code changes and higher safety standards are leading to more arc fault and ground fault circuit interrupter installations. Eaton offers a unique product solution that enables a direct connection of the breaker to the neutral bar, eliminating the need for wiring a pigtail.

#### Features and Benefits

- Time savings up to 25% per AFCI/GFCI installation
- Eliminates nuisance tripping due to loose pigtail connections
- Clean gutter space
- Easier troubleshooting due to less wiring
- Backed by a limited lifetime warranty

#### Product Selection

##### Main Breaker Plug-On Neutral Loadcenters

Main Breaker Type	Main Ampere Rating	Max. Number 3/4-Inch Poles	Enclosure Type	Wire Size Range for Main Breaker	Catalog Number	Cover Catalog Number	
						Combination	Surface
CSR 25 kAIC	100	24	Indoor	#2–300 kcmil	CH24BPN100E	CH8EF	CH8ES
	200	32	Indoor	#2–300 kcmil	CH32BPN200J	CH8JF	CH8JS
	200	42	Indoor	#2–300 kcmil	CH42BPN200K	CH8KF	CH8KS
	200	60	Indoor	#2–300 kcmil	CH60BPN200N	CH8NF	CH8NS

##### Main Lug Only/Convertible Plug-On Neutral Loadcenters—With Factory Installed Main Lugs

Max. Ampere Rating	Max. Number 3/4-Inch Poles	Enclosure Type	Catalog Number	Wire Size Range for Main Breaker	Cover Catalog Number	
					Combination	Surface
125	24	Indoor	CH24NLPN125E ①	#6–300 kcmil	CH8NLEF	CH8NLES
225	32	Indoor	CH32NLPN225J	#6–300 kcmil	CH8NLJF	CH8NLJS
225	42	Indoor	CH42NLPN225K	#6–300 kcmil	CH8NLKF	CH8NLKS
225	60	Indoor	CH60NLPN225N	#6–300 kcmil	CH8NLNF	—

#### Note

① Maximum 125 A main device.

Renovation Panel



### Contents

<i>Description</i>	<i>Page</i>
Overview . . . . .	V1-T1-2
CH Specialty Products	
Spa Panels . . . . .	V1-T1-13
Surge Panel . . . . .	V1-T1-14
Plug-On Neutral Loadcenter . . . . .	V1-T1-16
Type CH Renovation Loadcenter	
Type CH Retrofit Interior Kits . . . . .	V1-T1-18
CH Loadcenter Options and Accessories . . . . .	V1-T1-21
CH Circuit Breakers . . . . .	V1-T1-31

## Type CH Renovation Loadcenter

### Product Description

Eaton's Renovation Loadcenter is designed for the service contractor. With the addition of a five-circuit terminal block factory mounted in the top left corner of the loadcenter, the service contractor can terminate short-circuit wires instead of having to use expensive wire nuts. Also, the Renovation Loadcenter incorporates a twin-stacked neutral design that places the neutral and ground terminations higher in the loadcenter. Both of these features were added without increasing any size from a standard loadcenter. These features will eliminate the need for wire nuts and make for a much neater installation. There is a provision to field mount a second five-circuit terminal block (RN5TB) in the top right corner of the loadcenter. Choose amongst Eaton's Type CH breaker family for use in the Renovation Panel.

### Product Selection

#### Single-Phase—Main Circuit Breaker Loadcenters 25 kAIC<sup>①</sup>

#### Single-Phase, Three-Wire—120/240 Vac—Stacked Split Neutral

Main Breaker Type	Main Ampere Rating	Max. Number 3/4-Inch (19.1 mm) of Poles	Enclosure Type	Box Size	Wire Size Range Cu/Al 60 °C or 70 °C for Main Breakers	Loadcenter Catalog Number	Cover Catalog Number <sup>②</sup>	
							Combination	Surface
CH	100	20	Indoor	C	#6–1/0	CH22B100CRN	CH8CFF	CH8CS
CSR	150	32	Indoor	J	#2–300 kcmil	CH32B150JRN	CH8JF	CH8JS
CSR	200	32	Indoor	J	#2–300 kcmil	CH32B200JRN	CH8J	CH8JS
CSR	200	42	Indoor	K	#2–300 kcmil	CH42B200KRN	CH8KF	CH8KS

#### Branch Circuit Breakers (CH)

See **Pages V1-T1-2–V1-T1-12.**

#### Renovation Loadcenter

Description	Catalog Number
Five-circuit terminal block kit	<b>RN5TB</b>
Ground bar kits (two maximum per panel)	(See <b>Page V1-T1-24</b> )

#### Notes

- ① 100 A main breaker is rated 10 kAIC.
  - ② Combination style covers may be used in surface or flush applications.
- All main circuit breaker loadcenters are listed for use as service entrance equipment. Loadcenters are factory-bonded for service entrance applications. Remove bonding strap for separate neutral and ground bars for sub-feed applications.

#### Type CH Retrofit Interior



Type CH Retrofit Adjustable Interior



Type CH Retrofit Interior Collar and Assembly with Trim

### Contents

<b>Description</b>	<b>Page</b>
Overview . . . . .	V1-T1-2
CH Specialty Products	
Spa Panels . . . . .	V1-T1-13
Surge Panel . . . . .	V1-T1-14
Plug-On Neutral Loadcenter . . . . .	V1-T1-16
Type CH Renovation Loadcenter . . . . .	V1-T1-17
Type CH Retrofit Interior Kits	
CH Loadcenter Options and Accessories . . . . .	V1-T1-21
CH Circuit Breakers . . . . .	V1-T1-31

### Type CH Retrofit Interior Kits

#### Product Description

Eaton’s unique Retrofit Interior allows the customer to cost-effectively and safely upgrade an electrical service without removing the existing enclosure from the wall.

#### Application Description

The Retrofit Interior is designed and tested specifically for renovating an outdated electrical panel in an apartment, a condominium or a single family home. These outdated panels are being recognized by local inspectors and other authorities as a possible hazard.

#### Opportunities to Retrofit

- Single- or three-phase
- Main lug only or main breaker
- Up to 42 circuits
- Up to 225 A interiors, 400 A available upon request
- Available with CH breakers (3/4-inch) with copper bus or BR breakers (1-inch) with aluminum bus
- The minimum lifetime warranty for residential breakers shall be as follows:
  - Limited lifetime warranty on all CH branch breakers and loadcenters
  - Refer to Eaton for complete warranty details

#### Features and Benefits

##### Upgrading Existing Electrical Infrastructure Is Simple

- Replaces vintage brands that have hard to find, expensive replacement breakers
- Safely upgrade to arc fault and ground fault breakers to meet current electrical codes
- Maximizes number of circuits available with compact design
- Eco-friendly in asbestos-filled environments
- Exclusive design

##### Save Time and Money Throughout the Installation

- Uses existing panel box and wires
- Eliminates expensive and time-consuming drywall/paint repair
- Saves 2–3 hours of installation time compared to a complete panel changeout
- Eliminates precise measurements with field-adjustable kit

#### Standards and Certifications

Meets 2017 NEC wire bending requirements.

### CH Specialty Product Selection

To select the retrofit kit:

1. From the existing box size determine which retrofit groups are suitable (may be more than one).
2. Use type of interior, number of phases, and type of main to find the selection chart.
3. Select part number from chart (if main breaker, replace XXX with specific amp rating).

#### How to Order:

1. Measure the existing panel enclosure to determine appropriate kits for your project.
2. Match the existing dimensions with the table below to obtain the correct catalog number.
3. Order your retrofit kit from a local Eaton authorized distributor.

Need assistance or can't find retrofit to fit existing enclosure?

Phone:  
800-330-6479

E-mail:  
FlexCenterLincoln@Eaton.com

Locate an Eaton Certified Contractor at  
EatonCertified.com

### Retrofit Interior Kit Specifications

Catalog Number <sup>①</sup>	Cover <sup>②</sup>	Existing Enclosure Parameters—Inches (mm)				Phase	Main	Bus	Amperes <sup>③</sup>	Spaces / Circuits	UL 67 Listed
		Minimum Depth	Maximum Depth	Minimum Width	Minimum Height						
<b>CH Retrofit Interiors and Covers</b>											
RWCH6L125N	CRWCH6ML****	3.13 (79.5)	4.13 (104.9)	7.00 (177.8)	10.00 (254.0)	Single	MLO	CH	125	6	No
RSCH10B125N	CRWCH12ML****	3.50 (88.9)	4.50 (114.3)	8.50 (215.9)	16.50 (419.1)	Single	MCB	CH	125	10	No
RSCH12L125N	CRWCH12ML****	3.50 (88.9)	4.50 (114.3)	8.50 (215.9)	16.50 (419.1)	Single	MLO	CH	125	12	No
RACH22B125_	CRACH24ML****	3.75 (95.3)	4.25 (108.0)	13.00 (330.2)	21.00 (533.4)	Single	MCB	CH	125	22	No
RACH24L125_	CRACH24ML****	3.75 (95.3)	4.25 (108.0)	13.00 (330.2)	21.00 (533.4)	Single	MLO	CH	125	24	No
RBCH24B200_	CRBCH24CS****	3.75 (95.3)	6.00 (152.4)	13.00 (330.2)	29.00 (736.6)	Single	MCB	CH	200	24	No
RBCH32L200_	CRBCH32ML****	3.75 (95.3)	6.00 (152.4)	13.00 (330.2)	29.00 (736.6)	Single	MLO	CH	200	32	No
RCCH32B200_	CRBCH32CS****	3.75 (95.3)	6.00 (152.4)	13.00 (330.2)	34.00 (863.6)	Single	MCB	CH	200	32	No

### Complete Assembly

**Note:** For complete assembly, interior and cover need to be ordered separately.

#### Adjustable Interior

- Factory installed ground and neutral bars positioned to accept existing wires
- Field adjustable depth matches existing panel box
- Adjustable height enables optional placement of the interior
- Field bondable for service entrance options



Adjustable Interior

#### Standard Trim and Collar

- Standard trim matches new interior
- New circuit directory for updated labeling
- Oversized collar eliminates expensive wall/paint repair



Collar and Assembly with Trim

#### Notes

① Catalog numbers shown with “\_” at the end need one of the following suffixes to denote depth:  
J = 3.75–4.25  
K = 4.25–5.00  
L = 5.00–6.00  
Example: RBCH24B200J would signify an interior set with a depth range of 3.75 to 4.25 inches.

② \*\*\*\*Denotes characters in the catalog number that relate to overall cover size. Example: CRWCH6ML2620 would signify a cover 26.00 inches H x 20.00 inches W, or CRBCH24CS3324 would be 33.00 inches H x 24.00 inches W.

③ Amperes for MB panels is maximum; catalog number will reflect actual amperage of breaker included.

For UL applications, maximum cover sizes may apply.

# 1.1

## Loadcenters and Circuit Breakers

### Type CH Loadcenters and Circuit Breakers

#### 1

#### Non-Metallic Loadcenter

##### Single-Phase—Main Lug Loadcenters, Non-Metallic

2460SNM



##### Single-Phase Three-Wire—120/240 Vac—Insulated/Bondable Neutral

Main Ampere Rating	Maximum Number 1-Inch (25.4 mm)		Enclosure Type	Trim Type	Box Size	Wire Size Range Cu/Al 60 °C or 75 °C for Main Lugs	Loadcenter Catalog Number
	Spaces	Circuits					
40 <sup>①</sup>	2	4	Indoor	Flush (no door)	2	<sup>②</sup>	TT120FLGNM <sup>②③</sup>
	2	4	Indoor	Surface (no door)	2		TT120SLGNM <sup>②③</sup>
60	2	4	Indoor	Flush (no door)	2	#14–2	2460FNM
	2	4	Indoor	Surface (no door)	2		2460SNM
	2	4	Indoor	Flush (no door)	2		2460FGNM <sup>③</sup>
	2	4	Indoor	Surface (no door)	2		2460SGNM <sup>③</sup>
	2	4	Indoor	Surface (no door)	2		2460SGNM <sup>③</sup>
	2	4	Outdoor	—	—		2460RNM-A2

#### Notes

- ① Suitable for use as service equipment when not more than six main disconnecting means are provided and when not used as a lighting and appliance panelboard.
- ② This device has no main lugs. A Type BR or BD breaker is required to be backed to supply power to branch breakers. This device is single-phase 120 Vac only. With the use of three Type BR breakers, there are two branch circuits available. With the use of three Type BD breakers, there are five branch circuits available.
- ③ Includes GB4NM ground bar.

### Options and Accessories—Mechanical Interlocks



### Contents

Description	Page
Overview	V1-T1-2
CH Specialty Products	
Spa Panels	V1-T1-13
Surge Panel	V1-T1-14
Plug-On Neutral Loadcenter	V1-T1-16
Type CH Renovation Loadcenter	V1-T1-17
Type CH Retrofit Interior Kits	V1-T1-18
CH Loadcenter Options and Accessories	
Technical Data and Specifications	V1-T1-26
Dimensions	V1-T1-29
CH Circuit Breakers	V1-T1-31

## CH Loadcenter Options and Accessories

### Product Selection

#### CHSF2125



#### Field Installation and Parts

##### Description

Sub-feed lug blocks—two-pole, 125 A, 3/4-inch (19.1 mm) spaces needed

Sub-feed lug blocks—three-pole, 125 A, 3/4-inch (19.1 mm) spaces needed

Neutral/ground lug—add-on neutral or ground lug

##### Ordering Quantity <sup>①</sup>

##### Catalog Number

1 CHSF2125

1 CHSF3125

1 NL20

1 NL30

1 NL300

#### CHSF3125



Filler plates—3/4-inch (19.1 mm) space circuit breaker space

CSR main circuit breaker filler plate (with hardware)

Door lock—12–42 circuits, and 100–225 A

Sandlewood spray paint

ANSI-61 light gray touchup paint for outdoor loadcenters

25 CHFP

1 CSRFP

1 TDL

1 SPCSW

1 SPC61

#### CHFP



Isolated neutral assembly (computer circuits)

1 BINA

#### TDL



Circuit directory—adhesive backed

10 TCD

Cover screws

25 LCCS

Cover replacement latch 14-5/16 inch (363.55 mm) wide loadcenters only

1 CHRLS

Circuit marking strip (next to breakers)

10 CHMS

Circuit identification label (preprinted breaker labels next to breakers)

25 CHBL

Series rated caution label

25 SRL

Branch circuit numbering strip

20 CHNS

Bonding strap with screw

1 BSSUSE

CH plug-on neutral ground bonding strap

1 BSCHPON

#### BINA



#### Note

<sup>①</sup> Must be purchased in multiples of ordering quantities indicated.

# 1.1

## Loadcenters and Circuit Breakers

### Type CH Loadcenters and Circuit Breakers

1

#### Main Breaker Kits

Maximum Main Ampere Rating	Catalog Number	
	25 kAIC	35 kAIC
100	CSR2100N	CSH2100N
150	CSR2150N	CSH2150N
200	CSR2200N	CSH2200N
225	CSR2225N	CSH2225N

#### Main Lug Kits

Maximum Main Ampere Rating	Catalog Number
125	CHL125N
225	CHL225N



#### Main Breaker Kits

Breaker Ampere Rating	Lug Size	Catalog Number
100	#2–300 kcmil	CSR2100
150	#2–300 kcmil	CSR2150N
200	#2–300 kcmil	CSR2200N
225	#2–300 kcmil	CSR2225N

#### Mechanical Interlock Covers

Covers mechanically interlock two breakers. Type A covers interlock two CH breakers mounted across from one another. Type B covers interlock a main Type CSR breaker with a Type CH.

#### Mechanical Interlocks

	Type	Fits Loadcenter Catalog Numbers	Mechanical Interlock Trim/Deadfront Catalog Numbers	
			Flush	Surface
<b>CH8BRM Type A</b> 	A	CH12L125B	CH8BFM	CH8BSM
		CH16L125B		
		CH12L3125B		
		CH14B100B		
		CH20L125C	CH8CFM	CH8CSM
		CH24L125C		
		CH18L3125C		
		CH24L3125C		
		CH22B100C		
		CH22N100C		
		CH24L150D	CH8DFM	CH8DSM
		CH32L150D		
		CH24L3225D		
		CH30L3150D		
		CH42L225G	CH8GFM	CH8GSM
CH42L3225G				
Inner cover of Box B raintight	—	CH8BRM		
Inner cover of Box C raintight	—	CH8CRM		
<b>Indoor</b>				
<b>CH8EFM Type B</b> 	B	CH24B150E	CH8EFM	CH8ESM
		CH24B200E		
		CH24BPN200E		
		CH32B150J	CH8JFM	CH8JSM
		CH32B200J		
		CH3242B200J		
		CH32BPN200J		
		CH32N200J		
		CH32B225J		
		CH42B200K	CH8KFM	CH8KSM
		CH42N200K		
		CH42BPN200K		
		CH42B225K		
		CH60BPN200N	CH8NFM	—

### CH8EFM Type B



### Mechanical Interlocks, continued

Type	Fits Loadcenter Catalog Numbers	Mechanical Interlock Trim/Deadfront Catalog Numbers		
		Flush	Surface	
<b>Outdoor</b>				
B	CH8B150RF	CH3RDF7M	—	
	CH8B200RF			
	CH8N200RF			
	CH12B200RF			
	CH24B150R			
	CH24B200R			
	CH32B150R	CH3RDF9M	—	
	CH32B200R			
	CH32N200R			
	CH32B225R			
	CH42B200R	CH3RDF10M	—	
	CH42N200R			
	CH42B225R			
	<b>Next Generation Power Center</b>			
B	CHPC32B150L	CHPC8B32LFM	—	
	CHPC32B200L			
	CHPC32N200L			
	CHPC42B150L	CHPC8B42LFM	—	
	CHPC42B200L			
	CHPC42N200L			
	CHPC32B125TR	CH3RDF15M	—	
	CHPC32B150TR			
	CHPC32B200TR			
	CHPC32N200TR			
	CHPC42B150TR	CH3RDF16M	—	
	CHPC42B200TR			
	CHPC42N200TR			
	CHPC32B150TR	CH3RDF17M	—	
	CHPC32B200TR			
	CHPC42B200BR	CH3RDF18M	—	
	<b>Vintage <sup>①</sup></b>			
		CH20JJM200	CH7JFREPLM	—
	CH24JJM150			
	CH30JJM150			
	CH30JJM200			
	CH30JJM150H			
	CH3040JMM200			
	CH304JJM150			
	CH304JJM200			
	CH304JJM200H			
	CH30KKM225	CH7KKFREPLM	—	
	CH40KKM200H			
	CH40KKM225			
	CH40KKM200H			
	CH40KKM225H			
	CH304KKM200			
	CH304KKM200H			
	CH304LLM225	CH7LLFREPLM	—	
	CH424LLM225H			

**Note**

<sup>①</sup> If vintage part number does not match exactly, the cover may not fit. Simple variations such as an "N" at the end of the part number contain minor design variations that will prevent our cover from working with that particular loadcenter.



# 1.1

## Loadcenters and Circuit Breakers

### Type CH Loadcenters and Circuit Breakers

1

#### DS100H1



#### Field Installation Rainproof Conduit Hubs

Description	Conduit Size Inches (mm)	Ordering Quantity <sup>①</sup>	Catalog Number
Group 1—for use with 70, 100 and 125 A MLO and MCB loadcenters and circuit breaker enclosures	0.75 (19.1)	1	DS075H1
	1.00 (25.4)	1	DS100H1
	1.25 (31.8)	1	DS125H1
	1.50 (38.1)	1	DS150H1
	2.00 (50.8)	1	DS200H1
Group 2—for use with 150, 200 and 225 A MLO and MCB loadcenters and circuit breaker enclosures	2.00 (50.8)	1	DS200H2
	2.50 (63.5)	1	DS250H2
	3.00 (76.2)	1	DS300H2
Adapter kit—allows installing a Group 1 hub on devices arranged for Group 2 hubs	—	1	DS900AP
Group 1—small blank hub closure plate	—	1	DS900CP1
Group 2—large blank hub closure plate	—	1	DS900CP2

#### GBK14



#### Ground Bar Kits

Description (See Legend)	Length Inches (mm)	Ordering Quantity <sup>②</sup>	Catalog Number
●○○○○●○	2.54 (64.5)	1	GBK5 <sup>②</sup>
●○○○○●■	3.59 (91.2)	1	GBK520 <sup>②</sup>
●○○○○●○○○○○	4.29 (109.0)	1	GBK10 <sup>②</sup>
●○○○○●○○○○○■	5.34 (135.6)	1	GBK1020 <sup>②</sup>
— — — — —	4.61 (117.1)	1	GBK13 <sup>②</sup>
●○○○○●○○○○○○○○○	5.69 (144.5)	1	GBK14 <sup>②</sup>
●○○○○●○○○○○○○○○■	6.74 (171.2)	1	GBK1420 <sup>②</sup>
●○○○○●○○○○○○○○○○○	8.14 (206.8)	1	GBK21 <sup>②</sup>
●○○○○●○○○○○○○○○○○■	9.19 (233.4)	1	GBK2120 <sup>②</sup>
○○○○○○●○○○○○●○○○○○	7.94 (201.7)	1	CH9GP21 <sup>③④</sup>

#### Ground Bar Legend

- = (3) #14–#10 Cu/Al or (1) #14–#4 Cu/Al
- = (1) #6–2/0 Cu/Al
- = (1) 1/0–14 or (3) #10–12 Cu/Al
- ⋈ = (1) #14–1/0 Cu/Al or (3) #14–#10 Cu/Al
- = Mounting hole

#### Grounded “B” Phase Adapters

Maximum Amperes	Three-Phase Loadcenter Types of Panels	Kit Catalog Number <sup>⑤</sup>
125	12–32 circuit main lug	CHGRD1
225	Main lug and CHH main breaker panels	CHGRD2
	CC main CB panels	CHGRD3

#### Neutral Bar Accessories

Description	Catalog Number <sup>⑤</sup>
Replacement neutral for all B and C type boxes	CHN125C
Replacement neutral for all D type boxes	CHN125D
Replacement neutral for all E, G, J, K and L type boxes	CHN225L
Isolated Neutral Assembly (computer circuits)	BINA

#### Notes

- ① Must be purchased in multiples of ordering quantities indicated.
- ② Distance between mounting holes is 1-3/4 inches (44.5 mm).
- ③ For single- and three-phase 400 A loadcenters.
- ④ Distance between mounting holes is 2-13/32 inches.
- ⑤ Cannot be used in Safety Breaker Panels. Classic Plus Panels only.

### Decorator Cover Accessory

- For easy use with CH loadcenters mounted in living space
- Easily wallpapered or painted to match any decor
- Loadcenter accessory—exclusively from Eaton



*Now you see it ...*

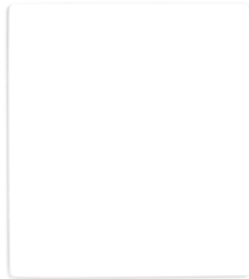

*... Now you don't.*

### Decorator Cover Accessory

Catalog Number	Existing CH Loadcenter Cover
CH8BF	CH8KDNB
CH8CF	CH8KDNC
CH8DF/EF	CH8KDND
CH8GF/JF	CH8KDNJ
CH8KF	CH8KDNK

### Loadcenter Goof Collars

Don't let an ugly drywall problem ruin a beautiful electrical installation.

Eaton's Goof Collar is designed to cover gaps between the finished drywall and loadcenter enclosure. This is often necessary when upgrading the electrical service and the drywall surrounding the panel is damaged. The collar allows 2 inches of overhang beyond the standard flush trim.



*Before*



*After*

### CH Goof Collars

Inches (mm)		Catalog Number	
Height	Width	Loadcenter Cover	Goof Collar
21.00 (533.4)	19.00 (482.6)	CH8BF	CH8BFC1921
26.00 (660.4)	19.00 (482.6)	CH8CF	CH8CFC1926
34.00 (863.6)	19.00 (482.6)	CH8DF	CH8DFC1934
		CH8EF	
		CHSUR8EF	
39.00 (990.6)	19.00 (482.6)	CH8GF	CH8JFC1939
		CH8JF	
42.00 (1066.8)	19.00 (482.6)	CH8KF	CH8KFC1942
		CHSUR8KF	
44.00 (1117.6)	19.00 (482.6)	CH8LF	CH8LFC1944
		CHSUR8LF	

**Technical Data and Specifications****General**

- A. The Contractor shall furnish and install loadcenters incorporating circuit breakers of the number, rating and type as specified herein and as shown on the contract drawings.
- B. The loadcenter and all components shall be designed, manufactured and tested in accordance with the latest applicable standards of UL and NEMA including:
  1. UL 67—standards for panelboards
  2. UL 50—standards for cabinets and boxes
  3. UL 489—standards for molded case circuit breakers
  4. Federal Spec Classification W-C 375
  5. UL 1699—all fault interrupting

**Qualifications**

- A. The manufacturer of the loadcenter shall be the manufacturer of the circuit breaker within the load center. All breakers shall be full size.
- B. For the equipment specified herein, the manufacturer shall be ISO® 9000 certified.
- C. The manufacturer of this equipment shall have produced similar electrical equipment for a minimum period of seven (7) years.

**Manufacturers**

- A. Eaton

**Ratings**

- A. Loadcenters shall be rated for 240 Vac and shall have short-circuit ratings as shown on the drawings or as herein scheduled, but not less than 10,000 amperes rms symmetrical.
- B. Breakers shall be full size and a minimum of 125 A frame. Breakers 10 –125 A trip size shall take up the same pole spacing.
- C. Loadcenters shall be labeled with a UL short-circuit rating. When series ratings are applied with integral or remote devices, a label shall be provided. Series ratings shall cover all trip ratings of installed frames. It shall state the conditions of the UL series ratings including:
  1. Size and type of upstream device.
  2. Branch devices that can be used.
  3. UL series short-circuit rating.

**Construction**

- A. All interiors, with the exception of the branch circuit breakers shall be completely factory assembled with main breakers, main lugs or no main device.
- B. Interiors shall be so designed that circuit breakers can be replaced without disturbing adjacent units and without removing the main bus connectors and shall be so designed that circuits may be changed without machining, drilling or tapping.
- C. Physical means must be provided to prevent the installation of more overcurrent devices than that number for which the enclosure was designed. Full size breakers are required.

**Bus**

- A. Busbars for the main and cross connectors shall be of silver flash plated copper construction in accordance with UL standards. Bussing shall be braced to 65 kAIC.
- B. Neutral bussing shall have a suitable lug for each outgoing feeder requiring a neutral connection of same ampacity as branch.

**Wiring/Termination**

- A. All wire connectors and terminals shall be of the anti-turn solderless type and suitable for copper or aluminum wire of the sizes indicated. All connectors shall meet the "Requirements for Wire Connectors and Soldering Lugs" UL 486B.
- B. All loadcenters where marked shall be suitable for use with 60/75 °C rated wire.

**Circuit Breakers**

- A. Circuit breakers shall be molded case type, 3/4-inch (19.1 mm) wide per pole. Multipole circuit breakers shall be of a stack pole design to provide electrical phase isolation and have an internal common trip.
- B. Each pole of the circuit breaker will have inverse time delay overload and instantaneous short-circuit protection by means of both thermal and magnetic sensors. Circuit breakers shall be quick-make/quick-break.
- C. The circuit breaker calibration shall not be affected by environmental changes in relative humidity. Breakers shall be calibrated after assembly.
- D. All circuit breakers shall be operated by a toggle-type handle and multipole circuit breakers shall have an internal common trip mechanism. The circuit breakers shall incorporate trip mechanisms that are mechanically trip-free from the handle. The handle position shall provide good visual trip indication.
- E. Contacts shall be of non-welding silver alloy.
- F. All branch breaker handles shall be of a different color than the case of the breaker.
- G. All terminals shall be listed for use with copper or aluminum conductors. Terminals shall be of the box lug design. The terminals shall meet UL 486B requirements and shall be suitable for use with either 60 °C or 75 °C wire.
- H. Breakers shall be SWD rated and/or HACR rated as required.
- I. Arc fault interrupting circuit breakers, (AFC), shall be provided on all 15 and 20 A single-phase 120/240 Vac circuits except those indicated as remote controlled breakers. AFC breakers shall be "Classified for mitigating the effects of arcing faults," or conforming to UL Standard 1699 and as defined by per Article 210.12 Section A of the NEC Code.

**Enclosures**

- A. Loadcenters shall have NEMA 1 general purpose or NEMA 3R rainproof enclosures as indicated on the drawings and shall be surface or flush mounted except where noted.
- B. For indoor applications, enclosures shall be rated NEMA 1. Enclosures shall be manufactured from cold-rolled code-gauge sheet steel having multiple knockouts and painted per paint specification. For outdoor applications, enclosures shall be rated NEMA 3R. Enclosures shall be manufactured from galvanized steel which shall be painted per the painted as specified. Enclosures shall be of sufficient size to meet or exceed NEC wire bending space.
- C. The cover shall have an easy adjustment feature for flush applications.
- D. Boxes shall be factory assembled into a single rigid structure.
- E. Provide circuit breaker marking labels and directories.

**Finish**

- A. Boxes and trims shall be finished with a high scratch-resistant aesthetically pleasing finish. The finish shall be polyurethane coating electrostatically applied to a thickness of 1.8 to 2 mils.

All loadcenters shall be provided with provisions for accepting a paintable or wall paperable decorator accessory cover. Where loadcenters are installed in living areas, provide manufacturer designed and tested decorator cover kits.

**CH Loadcenters****Description****Service**

Single-phase, three-wire, 120/240 Vac

Three-phase, four-wire, 208Y/120 Vac

Three-phase, three-wire, 240 V corner grounded delta

Three-phase, three-wire, 240 Vac delta

**Short-Circuit Current Rating**

10 kAIC: All single- and three-phase loadcenters 40–400 A, 2–42 circuits except when series ratings are applied

35 kAIC available on convertible units using CSH main breaker

25 kAIC: All factory-installed main breakers single-phase loadcenters rated 150–225 A using Type CSR main breakers

42 and 100 kAIC are available on some styles: single-phase and three-phase

**Main Breaker/Main Lug Loadcenters**

Single-phase

Three-phase

Main breaker: 100, 125, 150, 200, 225, 400 A

Main breaker: 150, 200, 225, 300, 400 A

Main lugs: 40, 70, 125, 150, 200, 225, 400 A

Main lugs: 125, 150, 200, 225, 400 A

**Convertible Loadcenters**

Main breaker or main lugs: single-phase up to 225 A

**Branch Breakers**

Type CH: 10–150 A. Single-, two- and three-pole. Selected amperages available in shunt trip, HACR and switching duty

Type CH-AFCI arc fault circuit interrupter

Ground fault circuit interrupters: 15–60 A

Type CHP: 10–125 A. Single-, two- and three-pole. three-position commercial trip

Type CH-HID: 15–30 A. Single-, two- and three-pole

Selected amperages available in HACR switching duty

CH-HM high magnetic

Type CHP-HID: 15–30 A. Single-, two- and three-pole

CH-M50 high ambient

Type CHP-GFCI: 15–30 A. Single-pole ground fault breakers

**Enclosures**

NEMA® Type 1 indoor

NEMA Type 3R outdoor

**Loadcenter and Breaker Accessories**

Branch circuit breaker:

Complete line of ground bar kits 5, 10, 14 and 21 circuits, some with additional #2/0 lugs

Auxiliary components

Each terminal will accommodate: (3) #14–#10 Cu/Al or (1) #14–#4 Cu/Al

Hold-down kits

Sub-feed lugs 125, 150 A—two- and three-pole

Handle ties

Shunt trips

Lockoffs

Universal rainproof conduit hubs Group One: 3/4, 1, 1-1/4, 1-1/2, 2 inches (19.1, 25.4, 31.8, 38.1, 50.8 mm)

Lockdogs

Group Two: 2, 2-1/2, 3 inches (50.8, 63.5, 76.2 mm)

Adapter plate

**Bussing**

Silver flash plated copper bus is a standard feature

### Dimensions

Approximate Dimensions in Inches (mm)

#### Residential/Commercial/Unit Enclosure—Box Sizes

**Note:** Box sizes do not include covers/fronts.

#### Residential Loadcenters

Box Size	Height	Width	Depth
<b>NEMA Type 1 Indoor</b>			
5	9.50 (241.3)	4.50 (114.3)	3.13 (79.4)
6	11.38 (288.9)	6.88 (174.6)	3.39 (86.1)
7	13.00 (330.2)	11.00 (279.4)	3.69 (93.7)
B	16.75 (425.5)	14.31 (363.5)	3.88 (98.4)
C	21.00 (533.4)	14.31 (363.5)	3.88 (98.4)
D	29.13 (739.8)	14.31 (363.5)	3.88 (98.4)
E	29.13 (739.8)	14.31 (363.5)	3.88 (98.4)
G	34.13 (866.8)	14.31 (363.5)	3.88 (98.4)
J	34.13 (866.8)	14.31 (363.5)	3.88 (98.4)
K	37.00 (939.8)	14.31 (363.5)	3.88 (98.4)
L	39.00 (990.6)	14.31 (363.5)	3.88 (98.4)
N	45.00 (1143.0)	14.31 (363.5)	3.88 (98.4)

#### NEMA Type 3R Outdoor

5R	9.50 (241.3)	4.50 (114.3)	3.13 (79.4)
6R	11.75 (298.5)	6.50 (165.1)	4.50 (114.3)
7R	13.00 (330.2)	11.00 (279.4)	3.69 (93.7)
B	16.75 (425.5)	14.31 (363.5)	5.19 (131.8)
C	21.00 (533.4)	14.31 (363.5)	5.19 (131.8)
D	29.13 (739.8)	14.31 (363.5)	5.19 (131.8)
E	29.13 (739.8)	14.31 (363.5)	5.19 (131.8)
G	34.13 (866.8)	14.31 (363.5)	5.19 (131.8)
J	34.13 (866.8)	14.31 (363.5)	5.19 (131.8)
K	37.00 (939.8)	14.31 (363.5)	5.19 (131.8)
L	39.00 (990.6)	14.31 (363.5)	5.19 (131.8)

#### Commercial Loadcenters

Box Size	Height	Width	Depth
<b>NEMA Type 1 Indoor</b>			
P	54.38 (1381.1)	21.00 (533.4)	6.00 (152.4)
PM	62.63 (1590.7)	21.00 (533.4)	6.00 (152.4)

#### Types ECB and ECC Unit Enclosures

Height	Width	Depth
<b>NEMA Type 1 Indoor</b>		
23.25 (590.6)	8.88 (225.4)	4.50 (114.3)
<b>NEMA Type 3R Outdoor</b>		
23.69 (601.7)	9.31 (236.5)	5.44 (138.1)

#### Residential Loadcenter Knockout

Residential NEMA Type 1 Indoor and NEMA Type 3R Outdoor Enclosures.

#### Knockouts for Box Sizes 5, 6, 7, 5R, 6R, 7R

Code	Diameter			
A	0.50 (12.7)	—	—	—
B	0.50 (12.7)	0.75 (19.1)	—	—
C	0.50 (12.7)	0.75 (19.1)	1.00 (25.4)	—
D	0.50 (12.7)	0.75 (19.1)	1.00 (25.4)	1.25 (31.8)
E	0.75 (19.1)	1.00 (25.4)	1.25 (31.8)	—
F	0.75 (19.1)	1.00 (25.4)	1.25 (31.8)	1.50 (38.1)
G	1.00 (25.4)	1.25 (31.8)	1.50 (38.1)	—
H	1.00 (25.4)	1.25 (31.8)	1.50 (38.1)	2.00 (50.8)
I	1.25 (31.8)	1.50 (38.1)	2.00 (50.8)	—

#### Knockout Positions

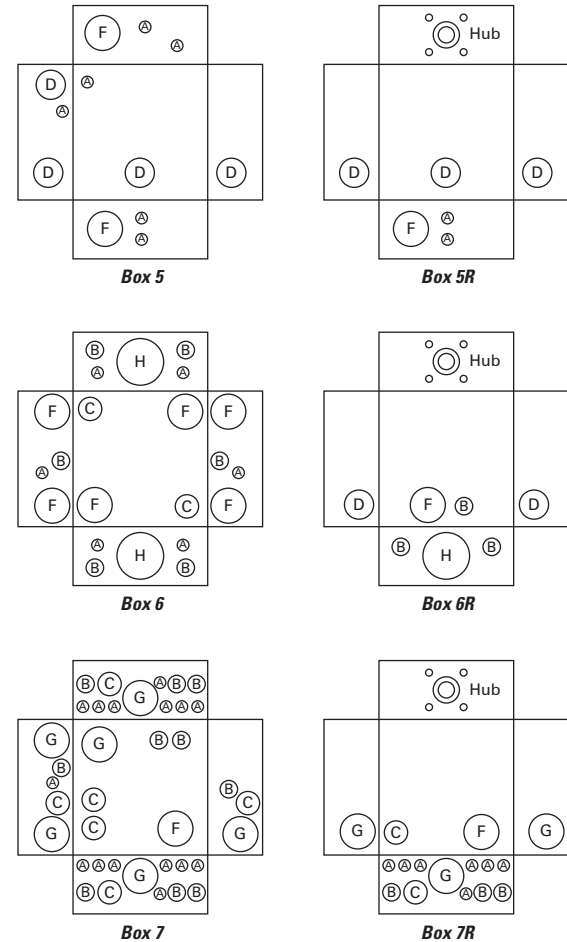

# 1.1

## Loadcenters and Circuit Breakers

### Type CH Loadcenters and Circuit Breakers

1

Approximate Dimensions in Inches (mm)

#### Residential and Commercial Loadcenter Knockout

Residential NEMA Type 1 indoor and NEMA Type 3R outdoor enclosures.

#### Knockouts for Box Sizes 8, 8R, P, PM, B, C, D, E, G, J, K, L, N and Outdoor Boxes 12–60 Circuits

Code	Diameter				
a	0.75 (19.1)	—	—	—	—
b	0.50 (12.7)	0.75 (19.1)	—	—	—
c	0.50 (12.7)	—	—	—	—
d	1.00 (25.4)	1.25 (31.8)	1.50 (38.1)	2.00 (50.8)	2.50 (63.5)
e	1.25 (31.8)	1.50 (38.1)	2.00 (50.8)	2.50 (63.5)	—
f	0.75 (19.1)	1.25 (31.8)	1.50 (38.1)	2.00 (50.8)	—
g	0.50 (12.7)	0.75 (19.1)	1.00 (25.4)	—	—
h	1.50 (38.1)	2.00 (50.8)	2.50 (63.5)	—	—
i	0.50 (12.7)	0.75 (19.1)	1.00 (25.4)	1.25 (31.8)	1.50 (38.1)
j	1.00 (25.4)	1.25 (31.8)	1.50 (38.1)	—	—
k	1.25 (31.8)	1.50 (38.1)	2.00 (50.8)	—	—
m	0.75 (19.1)	1.00 (25.4)	1.25 (31.8)	1.50 (38.1)	2.00 (50.8)
n	0.75 (19.1)	1.00 (25.4)	1.25 (31.8)	1.50 (38.1)	—
p	2.00 (50.8)	2.50 (63.5)	—	—	—

#### Knockout Diagram

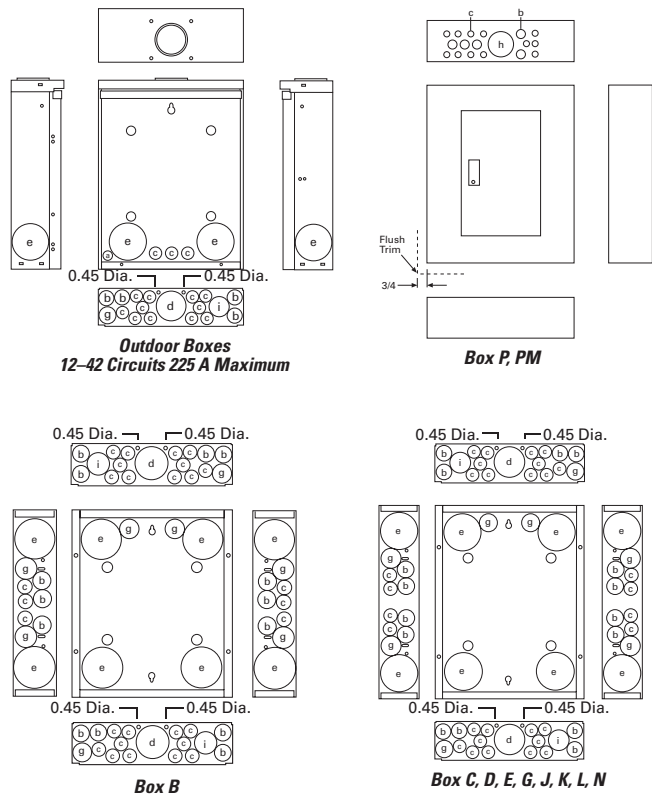

#### Type ECB and ECC Unit Enclosure Knockout

Code	Diameter				
<b>NEMA Type 1 Indoor (Flush and Surface Trims)</b>					
A	0.50 (12.7)	—	—	—	—
B	1.25 (31.8)	1.50 (38.1)	1.75 (44.5)	2.00 (50.8)	2.50 (63.5)
<b>NEMA Type 3R Outdoor</b>					
A	0.50 (12.7)	—	—	—	—
B	1.25 (31.8)	1.50 (38.1)	1.75 (44.5)	2.00 (50.8)	2.50 (63.5)

#### NEMA Type 1—Indoor

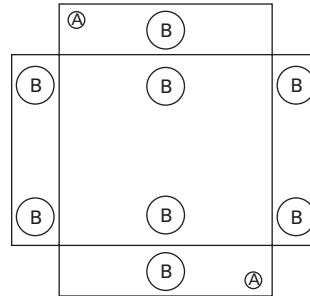

#### NEMA Type 3R—Outdoor

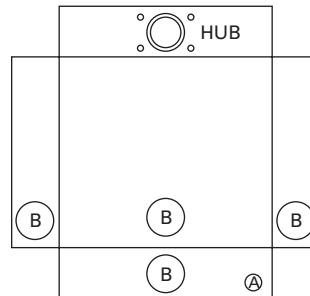

### Plug-On Circuit Breakers



## CH Circuit Breakers

### Product Description

Quick-make, quick-break switch mechanism combined with inverse time element tripping operation and trip-free handle design. Type CH circuit breakers trip to the OFF position, eliminating nuisance callbacks. The CHF family also includes a trip flag to differentiate between a trip and the breaker being turned off. The thermal-magnetic trip curve avoids nuisance tripping on mild overloads while reacting almost instantaneously to severe short-circuit conditions. Multipole breakers have internal common trip connection to operate all poles simultaneously. Handles are marked with ON-OFF indication and ampere rating of the breaker.

### Special Application Plug-On Circuit Breakers—Type CH 10 kAIC 120 Vac and 120/240 Vac

#### Branch Feeder Type Arc Fault Circuit Breakers

A branch feeder type arc fault circuit interrupter is a device intended to mitigate high current arcing faults in the complete circuit, including connected cords. High current arcing faults can occur from line to neutral or line to ground. These arcing faults are in parallel with the load and produce the most energy of all arcing faults.

The branch feeder type AFCI is required in the 1999 and 2002 National Electrical Code.

The Combination Type AFCI is required in all subsequent editions of the National Electrical Code.

#### Combination Type Arc Fault Circuit Breakers

A combination type arc fault circuit interrupter is a device that offers mitigation of high current arcing faults in the complete circuit, including connected cords. In addition it provides direct detection of persistent low current arcing faults down to 5 amps with associated mitigation of fire hazards in the cords connected to the outlets. High current arcing faults can occur from line to neutral or line to ground. These arcing faults are in parallel with the load and produce the most energy of all arcing faults. The current level of low current arcing faults is limited by the load.

#### Ground Fault Circuit Breakers—Ground Fault Application Notes

Single-pole Type CHGFI are designed for use in two-wire, 120 Vac circuits. The diagram on Page V1-T1-40 shows a typical wiring configuration.

## Contents

### Description

	<i>Page</i>
Overview .....	V1-T1-2
CH Specialty Products .....	V1-T1-13
CH Loadcenter Options and Accessories .....	V1-T1-21
CH Circuit Breakers	
Product Selection .....	V1-T1-32
Options and Accessories .....	V1-T1-38
Technical Data and Specifications .....	V1-T1-40
Wiring Diagrams .....	V1-T1-40

Two-pole Type CHGFIs are designed for use in three-wire, 120/240 Vac circuits, 120 Vac multiwire circuits employing common, neutral and two-wire, 240 Vac circuits obtained from a 120/240 Vac source.

Diagrams on Page V1-T1-40 illustrate typical wiring configurations for 120/240 Vac multiwire circuits.

The diagram on Page V1-T1-40 depicts a 240 Vac, two-wire circuit. Note the “panel neutral” conductor connects to the neutral bar,

even though the neutral is not included in the load circuit. This connection is necessary to supply a 120 Vac power source to the ground fault sensing circuit.

The figures are shown with a 120/240 Vac, single-phase, three-wire power source, but are also applicable to a 120/208 Vac, three-phase, four-wire power supply. For all figures, the electrical operation of the Type CHGFI is not affected by the equipment ground.

### Features

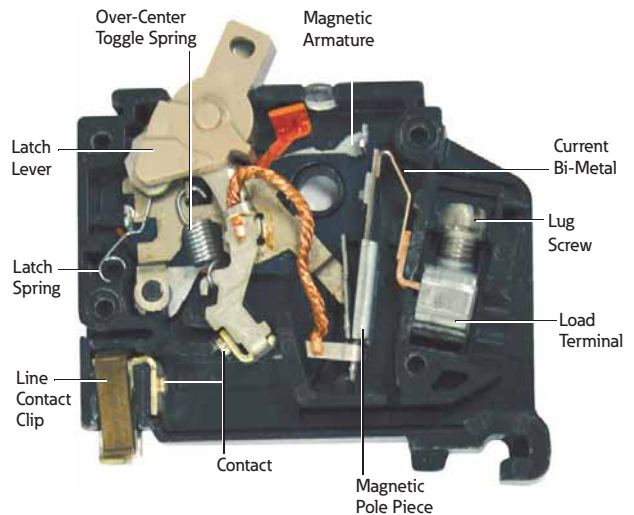



# 1.1

## Loadcenters and Circuit Breakers

### Type CH Loadcenters and Circuit Breakers

1



#### Product Selection

10 kAIC, 120 Vac, 120/240 Vac and 240 Vac

##### Type CH Plug-On Circuit Breakers





#### Type CH Breakers, 3/4-Inch (19.1 mm) per Pole 120, 120/240 or 240 Vac, 10 kAIC

Ampere Rating	Wire Size Range Cu/Al 60 °C or 75 °C	Catalog Number		
		Single-Pole 120/240 Vac Requires One 3/4-Inch (19.1 mm) Space 10 per Shelf Carton	Two-Pole 120/240 Vac Common Trip Requires Two 3/4-Inch (19.1 mm) Spaces 5 per Shelf Carton	Three-Pole 240 Vac Common Trip Requires Three 3/4-Inch (19.1 mm) Spaces 5 per Shelf Carton
10	(1) #14–8 ①	 <b>CH110</b>	 <b>CH210</b>	 <b>CH310</b>
15	(2) #14–10 ①② (1) #14–6 ③	<b>CH115</b> ⑥⑦	<b>CH215</b> ⑦	<b>CH315</b> ⑦
20		<b>CH120</b> ⑥⑦	<b>CH220</b> ⑦	<b>CH320</b> ⑦
25		<b>CH125</b> ⑦	<b>CH225</b> ⑦	<b>CH325</b> ⑦
30		<b>CH130</b> ⑦	<b>CH230</b> ⑦	<b>CH330</b> ⑦
35	#14–2 ① #14–6 ③	<b>CH135</b> ⑦	<b>CH235</b> ⑦	<b>CH335</b> ⑦
40	#10–1/0 ④	<b>CH140</b> ⑦	<b>CH240</b> ⑦	<b>CH340</b> ⑦
45	#14–2 #3/0	<b>CH145</b> ⑦	<b>CH245</b> ⑦	<b>CH345</b> ⑦
50		<b>CH150</b> ⑦	<b>CH250</b> ⑦	<b>CH350</b> ⑦
60		<b>CH160</b>	<b>CH260</b>	<b>CH360</b>
70		<b>CH170</b>	<b>CH270</b>	<b>CH370</b>
80		—	<b>CH280</b>	<b>CH3080</b>
90		—	<b>CH290</b>	<b>CH3090</b>
100		—	<b>CH2100</b>	<b>CH3100</b>
110		—	<b>CH2110</b>	—
125		—	<b>CH2125</b>	—

##### Type CH Plug-On Circuit Breakers



#### CHF Breakers with Mechanical Trip Flag

Ampere Rating	Wire Size Range Cu/Al 60 °C or 75 °C	Catalog Number	
		Single-Pole 120/240 Vac Requires One 3/4-Inch (19.1 mm) Space 10 per Shelf Carton	Two-Pole 120/240 Vac Common Trip Requires Two 3/4-Inch (19.1 mm) Spaces 5 per Shelf Carton
10	(1) #14–8 ①	 <b>CHF110</b>	 <b>CHF210</b>
15	(2) #14–10 ①②	<b>CHF115</b> ⑥⑦	<b>CHF215</b> ⑦
20		<b>CHF120</b> ⑥⑦	<b>CHF220</b> ⑦
25		<b>CHF125</b> ⑦	<b>CHF225</b> ⑦
30		<b>CHF130</b> ⑦	<b>CHF230</b> ⑦
35	#14–2 ①	<b>CHF135</b> ⑦	<b>CHF235</b> ⑦
40	#14–4 ④	<b>CHF140</b> ⑦	<b>CHF240</b> ⑦
45		<b>CHF145</b> ⑦	<b>CHF245</b> ⑦
50		<b>CHF150</b> ⑦	<b>CHF250</b> ⑦

##### Notes

- ① For single- and two-pole breakers.
- ② Solid and stranded wire can be used together.
- ③ For three-pole breakers.
- ④ Single-pole and two-pole 40–50 A.
- ⑥ Two-pole 150 A.
- ⑦ Switching duty rated.
- ⑦ HACR rated.

For factory-installed options, refer to **Page V1-T1-39**.

### Type CH AF/GF Single-Pole Circuit Breaker

Type CH AFCI Single-Pole Circuit Breaker



### Dual Purpose Arc Fault/Ground Fault 3/4-Inch (19.1 mm) Wide Circuit Breakers, Type CH, 120 Vac— 10 kAIC <sup>①②</sup>

Poles	Ampere Rating	Configuration	Catalog Number
Single-pole 10 kAIC	15	Combination AFCI GFCI	CHFAFGF115 <sup>③</sup>
	20	Combination AFCI GFCI	CHFAFGF120 <sup>③</sup>
Single-pole, plug-on neutral 10 kAIC	15	Combination AFCI GFCI	CHFAFGF115PN
	20	Combination AFCI GFCI	CHFAFGF120PN

### Plug-On Branch Feeder Type Arc Fault Circuit Breakers, Type CH 10 kAIC, 120 Vac and 120/240 Vac

Type CH AFCI Single-Pole Circuit Breaker



### Combination Type CH AFCI 3/4-Inch (19.1 mm) Wide Circuit Breakers

Poles	Ampere Rating	Catalog Number
<b>Standard Pigtail</b>		
Single-pole 10 kAIC	15	CHFCAF115
	20	CHFCAF120
Two-pole 10 kAIC	15	CH215CAF
	20	CH220CAF

Type CH AFCI Single-Pole Circuit Breaker



### Branch Type CH AFCI 3/4-Inch (19.1 mm) Wide FIRE-GUARD<sup>®</sup> Circuit Breakers

Poles	Ampere Rating	Configuration	Catalog Number
Single-pole 10 kAIC	15	AFCI	CH115AF <sup>③</sup>
	20	AFCI	CH120AF <sup>③</sup>
Two-pole 10 kAIC <sup>④⑤</sup>	15	AFCI common trip	CH215AF
	20	AFCI common trip	CH220AF

### Plug-On Combination Type Arc Fault Circuit Breakers and Ground Fault, Type CH 10 kAIC, 120 Vac and 120/240 Vac <sup>⑥</sup>

Type CH AFCI Single-Pole PON Combo Circuit Breaker



### Combination Type CH AFCI 3/4-Inch (19.1 mm) and CHGFCI Circuit Breakers

Poles	Ampere Rating	Configuration	Catalog Number
Single-pole 10 kAIC	15	AFCI plug-on neutral	CHFCAF115PN
	20	AFCI plug-on neutral	CHFCAF120PN
	15	GFCI plug-on neutral	CHFGFT115PN
	20		CHFGFT120PN
	25		CHFGFT125PN
	30		CHFGFT130PN

**Notes**

- ① Breaker qualifies as combination arc fault, per UL 1699.
- ② Breaker qualifies as personnel protection ground fault, (5 mA) per UL 943.
- ③ Clamshell packaging available with CS modification code on the end of catalog number.
- ④ Common trip refers to two-pole 240 V load application sourced by 120/240 Vac (see diagram on Page V1-T1-40).
- ⑤ Independent trip refers to two-pole multi-wire, home run or shared neutral circuits (see diagrams on Page V1-T1-40).
- ⑥ Requires plug-on neutral loadcenter.

# 1.1

## Loadcenters and Circuit Breakers

### Type CH Loadcenters and Circuit Breakers

1

#### Plug-On Ground Fault Circuit Breakers, Type CH 10 kAIC, 120 Vac and 120/240 Vac

##### Type CH Single-Pole



#### Type CH Ground Fault Circuit Breakers (5 Milliampere) 3/4-Inch (19.1 mm) per Pole 120 Vac or 120/240 Vac, 10 kAIC

Ampere Rating	Wire Size Range Cu/Al 60 °C or 75 °C ①	Catalog Number—1 per Shelf Carton	
		Single-Pole 120 Vac Requires One 3/4-Inch (19.1 mm) Space	Two-Pole 120/240 Vac Common Trip Requires Two 3/4-Inch (19.1 mm) Spaces
15	#14–6	CHFGFT115	CH215GFT
20	#14–6	CHFGFT120	CH220GFT
25	#14–6	CHFGFT125	CH225GFT
30	#14–6	CHFGFT130	CH230GFT
35	#14–6	—	CH235GFT
40	#14–6	—	CH240GFT
45	#14–6	—	CH245GFT
50	#14–6	—	CH250GFT
60	#14–6 ①	—	CH260GFT

##### Type CH Two-Pole



#### Type CH Ground Fault Equipment Protectors (30 Milliampere) 3/4-Inch (19.1 mm) per Pole 120 Vac or 120/240 Vac, 10 kAIC

Ampere Rating	Wire Size Range Cu/Al 60 °C or 75 °C ①	Catalog Number—1 per Shelf Carton	
		Single-Pole 120 Vac Requires One 3/4-Inch (19.1 mm) Space	Two-Pole 120/240 Vac Common Trip Requires Two 3/4-Inch (19.1 mm) Spaces
15	#14–6	CHFEP115	CH215EPD
20	#14–6	CHFEP120	CH220EPD
25	#14–6	CHFEP125	—
30	#14–6	CHFEP130	CH230EPD
40	#14–6	—	CH240EPD
50	#14–6	—	CH250EPD
60	#14–6 ①	—	CH260EPD

#### Type CH Switching Neutral Breakers—10 kAIC, 120 Vac and 120/240 Vac

Used to open the neutral along power line(s) for applications of gas pumps.

##### CH220SW



#### 3/4-Inch (19.1 mm) per Pole 120/240 or 240 Vac, 10 kAIC

Ampere Rating	Wire Size Range Cu/Al 60 °C or 75 °C	Catalog Number—1 per Shelf Carton	
		Two-Pole 120 Vac Common Trip Requires Two 3/4-Inch (19.1 mm) Spaces	Three-Pole 120/240 Vac Common Trip Requires Three 3/4-Inch (19.1 mm) Spaces
15	#14–8	CH215SW ②	CH315SW ③
20	#14–8	CH220SW ②	CH320SW ③
30	#14–8	CH230SW ②	CH330SW ③
40	#14–8	CH240SW ②	CH340SW ③
50	#14–8	CH250SW ②	CH350SW ③



##### Notes

- ① 60 A breaker listed for 75 °C Cu wire only.
- ② For circuit breakers with shunt trip, add ST suffix. Shunt trip requires one additional pole space.
- ③ Switching duty rated.

### Type CH-HID Circuit Breakers—10 kAIC, 120 Vac, 120/240 and 240 Vac

Suitable for use in circuits for fluorescent and high intensity discharge lighting. Also suitable for HACR applications.

#### 3/4-Inch (19.1 mm) per Pole 120 Vac, 120/240 and 240 Vac, 10 kAIC

Ampere Rating	Wire Size Range Cu/Al 60 °C or 75 °C	Single-Pole 120/240 Vac Requires One 3/4-Inch (19.1 mm) Space 10 per Shelf Carton Catalog Number	Two-Pole 240 Vac Common Trip Requires Two 3/4-Inch (19.1 mm) Spaces 5 per Shelf Carton Catalog Number	Three-Pole 240 Vac Common Trip Requires Three 3/4-Inch (19.1 mm) Spaces 5 per Shelf Carton Catalog Number
				
15	#14–8	CH115HID	CH215HID ①	CH315HID
20	#14–8	CH120HID	CH220HID	CH320HID
30	#14–8	CH130HID	CH230HID	CH330HID

### Type CHT Twin 10 kAIC, 120/240 Vac, Universal CTL and Non-CTL Plug-On Circuit Breakers

Suitable for CTL and Non-CTL loadcenters.

Type CH and CHT  
Circuit Breakers  
Mounted in Twin  
Breaker Panel

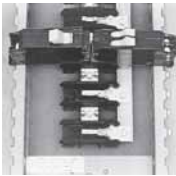

#### Twin (CTL) 3/4-Inch (19.1 mm) per Pole 120 Vac Class CTL 10 kAIC

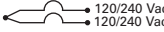
Ampere Rating	Wire Size Range Cu/Al 60 °C or 75 °C	Single-Pole Requires One 3/4-Inch (19.1 mm) Space 10 per Shelf Carton Catalog Number
		 120/240 Vac 120/240 Vac
15–15	#14–8	CHT1515 ②③
15–20	#14–8	CHT1520 ②③
20–20	#14–8	CHT2020 ②③

#### Notes

- ① CH215HID is rated for 120/240 V.
- ② Switching duty rated.
- ③ HACR rated.

# 1.1

## Loadcenters and Circuit Breakers



### Type CH Loadcenters and Circuit Breakers

1

#### Type CHP Commercial Breakers—10 kAIC, 120 Vac, 120/240 Vac and 240 Vac

Note: CHP breakers feature on-off and trip positions for commercial applications.

#### 3/4-Inch (19.1 mm) per Pole 120, 120/240 or 240 Vac, 10 kAIC

Ampere Rating	Wire Size Range Cu/Al 60 °C or 75 °C	Single-Pole 120/240 Vac Requires One 3/4-Inch (19.1 mm) Space 10 per Shelf Carton Catalog Number	Two-Pole 120/240 Vac Common Trip Requires Two 3/4-Inch (19.1 mm) Spaces 5 per Shelf Carton Catalog Number	Three-Pole 240 Vac Common Trip Requires Three 3/4-Inch (19.1 mm) Spaces 5 per Shelf Carton Catalog Number
				
10	(1) #14–8 ①	<b>CHP110</b>	<b>CHP210</b>	<b>CHP310</b>
15	(2) #14–10 ①② (1) #14–6 ③	<b>CHP115</b> ⑥⑦	<b>CHP215</b> ⑦	<b>CHP315</b> ⑦
20		<b>CHP120</b> ⑥⑦	<b>CHP220</b> ⑦	<b>CHP320</b> ⑦
25		<b>CHP125</b> ⑦	<b>CHP225</b> ⑦	<b>CHP325</b> ⑦
30		<b>CHP130</b> ⑦	<b>CHP230</b> ⑦	<b>CHP330</b> ⑦
35	#14–2 ① #14–6 ③	<b>CHP135</b> ⑦	<b>CHP235</b> ⑦	<b>CHP335</b> ⑦
40	#10–1/0 ④	<b>CHP140</b> ⑦	<b>CHP240</b> ⑦	<b>CHP340</b> ⑦
45	#14–2 ⑤	<b>CHP145</b> ⑦	<b>CHP245</b> ⑦	<b>CHP345</b> ⑦
50		<b>CHP150</b> ⑦	<b>CHP250</b> ⑦	<b>CHP350</b> ⑦
60		<b>CHP160</b> ⑦	<b>CHP260</b> ⑦	<b>CHP360</b> ⑦
70		<b>CHP170</b>	<b>CHP270</b>	<b>CHP370</b>
80		—	<b>CHP280</b>	—
90		—	<b>CHP290</b>	—
100		—	<b>CHP2100</b>	<b>CHP3100</b>
110		—	<b>CHP2110</b>	—
125		—	<b>CHP2125</b>	—

#### Notes

- ① For single- and two-pole breakers.
- ② Solid and stranded wire can be used together.
- ③ For three-pole breakers.
- ④ Single-pole 60–70 A, two-pole 80–125 A, three-pole 40–100 A.
- ⑤ Single-pole 40–50 A, two-pole 40–70 A.
- ⑥ Switching duty rated.
- ⑦ HACR rated.

CHP breakers offer on-off and trip positions for commercial applications.

### Type CHP Neutral Switching Breakers—10 kAIC, 120 Vac and 120/240 Vac

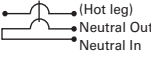
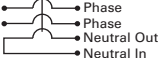

Used to open the neutral along power line(s) for applications of gas pumps.

#### 3/4-Inch (19.1 mm) per Pole 120 or 120/240 Vac, 10 kAIC

Ampere Rating	Wire Size Range Cu/Al 60 °C or 75 °C	Two-Pole 120 Vac Common Trip Requires Two 3/4-Inch (19.1 mm) Spaces 1 per Shelf Carton Catalog Number	Three-Pole 120/240 Vac Common Trip Requires Three 3/4-Inch (19.1 mm) Spaces 1 per Shelf Carton Catalog Number
			
15	#14–8	CHP215SW <sup>①</sup>	CHP315SW <sup>①</sup>
20	#14–8	CHP220SW <sup>①</sup>	CHP320SW <sup>①</sup>



### Type CH-M50 High Ambient Breaker

#### 3/4-Inch (19.1 mm) per Pole 120 or 120/240 Vac, 10 kAIC

Ampere Rating	Wire Size Range Cu/Al 60 °C or 75 °C	Single-Pole 120/240 Vac Requires One 3/4-Inch (19.1 mm) Space 10 per Shelf Carton Catalog Number	Two-Pole 120/240 Vac Common Trip Requires Two 3/4-Inch (19.1 mm) Spaces 5 per Shelf Carton Catalog Number
			
15	(1) #14–8	CH115M50	CH215M50
20	(2) #14–10	CH120M50	CH220M50
25		CH125M50	CH225M50
30		CH130M50	CH230M50
35		CH135M50	CH235M50
40		CH140M50	CH240M50
45		CH145M50	CH245M50
50		CH150M50	CH250M50
60		—	CH260M50
70		—	CH270M50

### Type CH-HM and CHP-HM High Magnetic Breakers

#### 3/4-Inch (19.1 mm) per Pole 120 or 120/240 Vac, 10 kAIC

Ampere Rating	Wire Size Range Cu/Al 60 °C or 75 °C	Single-Pole 120/240 Vac Requires One 3/4-Inch (19.1 mm) Space 10 per Shelf Carton Catalog Number	Two-Pole 120/240 Vac Common Trip Requires Two 3/4-Inch (19.1 mm) Spaces 5 per Shelf Carton Catalog Number
			
15	(1) #14–8	CH115HM	CH215HM
20	(2) #14–10	CH120HM	CH220HM
15	(1) #14–8	CHP115HM	CHP215HM
20	(2) #14–10	CHP120HM	CHP220HM

#### Note

<sup>①</sup> For circuit breakers with shunt trip, add ST suffix. Shunt trip requires one additional pole space, obtain pricing from [Page V1-T1-39](#).

# 1.1

## Loadcenters and Circuit Breakers

### Type CH Loadcenters and Circuit Breakers

1

#### Options and Accessories

CHHT



CHPL



CHPLGF



MCBPL



CHLO



CH125RB



CH9MB270



CHML



#### Field Installation Kits and Parts

Description	Ordering Quantity <sup>①</sup>	Catalog Number
<b>Handle Ties <sup>②</sup></b>		
Handle tie bar for physically joining the handles of two adjacent single-pole Type CH circuit breakers (molded plastic handle cover)	25	<b>CHHT</b>
<b>Handle Lockoffs <sup>③④</sup></b>		
Padlockable device for locking the handle of CH AFGF, CAF and GFT breakers into the ON or OFF position.		<b>CHFAFGFLOFF</b>
Padlockable device for locking the handle of single-, two- or three-pole Type CH circuit breakers (escutcheon mounted) <sup>⑤</sup>	1	<b>CHPL</b>
Padlockable device for locking the handle of a single-pole Type CHGFI circuit breaker (escutcheon mounted) <sup>⑤</sup>	1	<b>CHPLGF</b>
Padlockable bracket for locking the handle of two-, three- and four-pole Type CH circuit breakers	10	<b>CHPLOFF</b>
Padlockable device for locking the handle of main circuit breaker Types CC and CCH into the ON or OFF position.(screw mounted) <sup>⑥</sup>	1	<b>CCPL</b>
Padlockable device for locking the handle of main breaker Types BW and CSR into the ON or OFF position (escutcheon mounted) <sup>⑤</sup>	1	<b>MCBPL</b>
<b>Handle Lockdogs <sup>④⑦</sup></b>		
Device used to secure handle in ON or OFF position for single-pole Type CH circuit breakers (handle mounted) <sup>⑧</sup>	10	<b>CHLO</b>
<b>Hold-Down Kits <sup>⑨</sup></b>		
Hold-down retainer kit for single-, two-, three-pole Type CH circuit breakers. For 6–24 circuit 125 A single- and three-phase, 12–42 circuit single-phase 225 A and 24–42 circuit three-phase 225 A MLO Type CH loadcenters	1	<b>CH125RB</b>
Hold-down retainer kit for single-, two-, three-pole Type CH circuit breakers for 2–4 circuit MLO CH loadcenters.	1	<b>CH125RB24</b>
<b>Mounting Bases</b>		
Mounting base for two-pole Type CH circuit breaker—70 A maximum	1	<b>CH9MB270</b>
<b>Main Breaker Lug Kits</b>		
Types CC and CCH main breaker lug kit (2) 300 kcmil	1	<b>CCL300</b>
Type CSR main breaker lug kit (2) 300 kcmil	1	<b>MCBL300</b>
<b>Mechanical Interlock</b>		
Type CH for two-, three- and four-pole breakers	10	<b>CHML <sup>Ⓣ</sup></b>

#### Notes

- ① Must be purchased in multiples of ordering quantities indicated.
- ② Handle ties: typically used to join two similar independent single-pole breakers to form a two-pole noncommon trip breaker.
- ③ Handle lockoffs: devices that use a padlock to lock the circuit breaker's handle in the ON or OFF position.
- ④ Requires one additional pole space.
- ⑤ Escutcheon mounted: device mounted semipermanently to the face of the circuit breaker and secured by the loadcenter deadfront.
- ⑥ Screw mounted: device permanently mounted to the face of the circuit breaker by the use of a non-removable screw.
- ⑦ Handle lockdogs: devices that are used to secure a circuit breaker's handle in the ON or OFF position. Handle lockdogs are not padlockable devices.
- ⑧ Handle mounted: device mounted above or below handle using spring pressure.
- ⑨ Hold-down kits: devices used to secure the circuit breaker to the loadcenter for back-feed main application. See NEC Article 408.36(D).
- Ⓣ CHML not suitable to transfer emergency power.

### Shunt Trip Options

Description Type	Volts	Catalog Number Suffix Adder <sup>①</sup>
CSR	12 DC	<b>SR12</b>
CSR	24 DC	<b>SR24</b>
CSR	120 AC	<b>SR01</b>
CH	120 AC	<b>ST <sup>②</sup></b>
CC	12 DC	<b>SR12</b>
CC	24 DC	<b>SR24</b>
CC	120 AC	<b>SR01</b>
CC	208 AC	<b>SR08</b>
CC	240 AC	<b>SR02</b>

### Handle Position Changeability Chart

Handle Lockoff and Lockdog Types	To Change Handle Position from ON to OFF or OFF to ON You Must...		
	Remove Padlock	Remove Device	Remove Loadcenter Deadfront
Lockoff escutcheon mounted	Remove	—	—
Lockoff screw mounted	Remove	—	—
Lockdog handle mounted	N/A	Remove	—

#### Notes

- ① Add suffix indicated to end of breaker catalog number.
- ② Requires one additional pole space.



# 1.1

## Loadcenters and Circuit Breakers

### Type CH Loadcenters and Circuit Breakers

1

#### Technical Data and Specifications

##### Ratings

Single- and two-pole CH breakers rated 15 and 20 A have low instantaneous magnetic trip levels. The 15 and 20 A breakers with “HM” suffix have high magnetic trip settings recommended for circuits with inherently high inrush currents. All Type CH breakers are marked for heating, air conditioning and refrigeration (HACR) equipment application. Single-pole 15–20 A breakers are also suitable for switching duty (SWD). Shunt trip coils operate on 120 Vac and require one additional pole space per breaker.

##### Wiring Diagrams

###### Typical Single-Pole

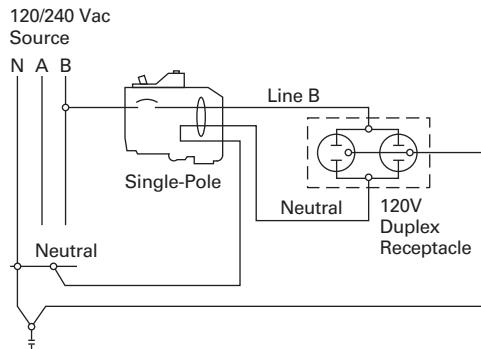

###### Two-Pole 240 V Load Application Sourced by 120/240 Vac

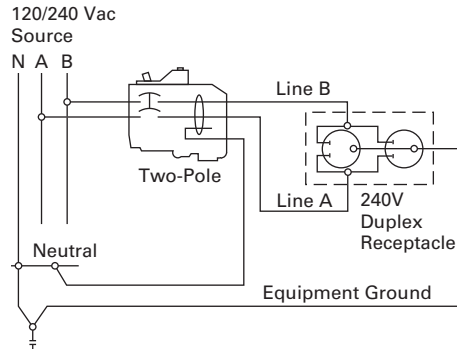

###### Single-Pole 120 V Load Application Sourced by 120/240 Vac

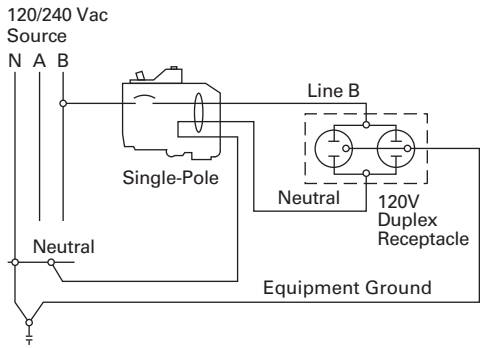

###### Two-Pole Shared Neutral with Duplex Receptacle Application

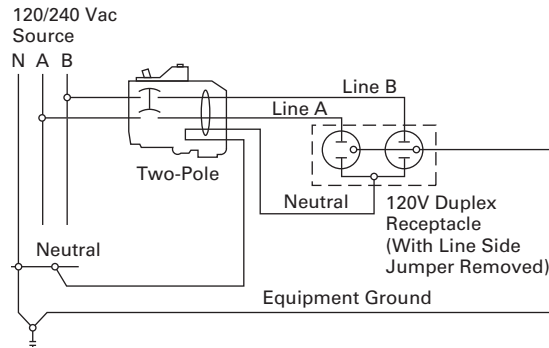

###### Two-Pole Shared Neutral with Multi-Duplex Receptacle Application

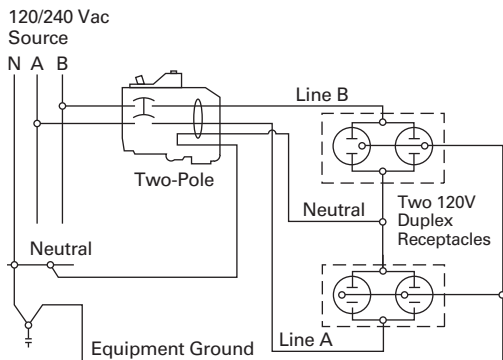

###### Single-Pole 120 V Duplex Receptacle Application

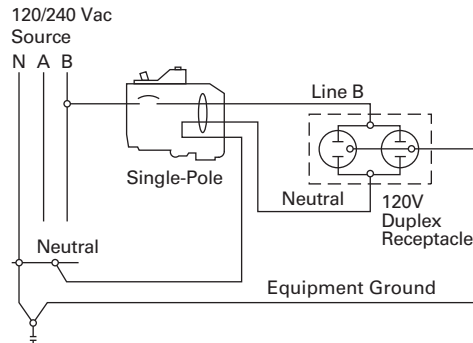

### Two-Pole 120 V Multi-Duplex Receptacle Application

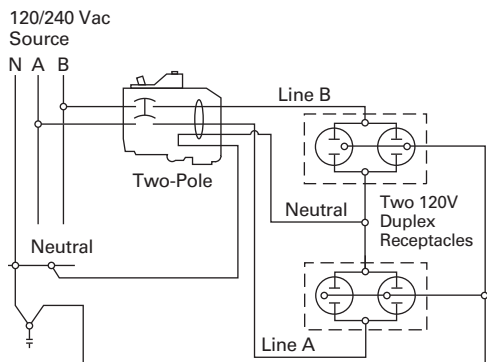

### Two-Pole 120 V Duplex Receptacle Application

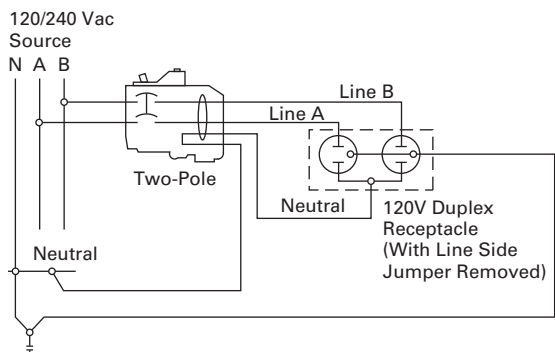

### Two-Pole 240 V Duplex Receptacle Application

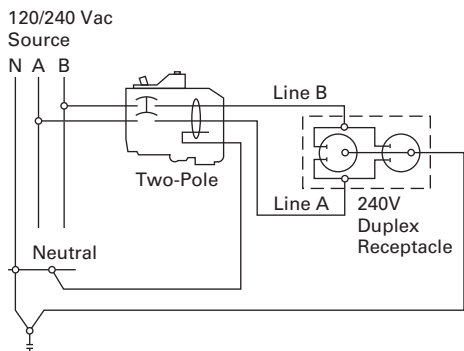

Type BR Loadcenters and Circuit Breakers



### Contents

<i>Description</i>	<i>Page</i>
Overview	
Standards and Certifications . . . . .	<b>V1-T1-43</b>
Catalog Number Selection . . . . .	<b>V1-T1-45</b>
Product Selection . . . . .	<b>V1-T1-46</b>
BR Specialty Products	
BR Plug-On Neutral Loadcenters . . . . .	<b>V1-T1-57</b>
BR Quick Connect Neutral Loadcenters . . . . .	<b>V1-T1-60</b>
Spa Panels . . . . .	<b>V1-T1-61</b>
Riser Panel . . . . .	<b>V1-T1-62</b>
Type BR Renovation Loadcenter . . . . .	<b>V1-T1-63</b>
BR Loadcenter Options and Accessories . . . . .	<b>V1-T1-66</b>
BR Circuit Breakers . . . . .	<b>V1-T1-80</b>

### Overview

#### Product Description

Loadcenters are enclosures specifically designed to house the branch circuit breakers and wiring required to distribute power to individual circuits. They contain either a main breaker when used at the service entrance point or a main lug when used as a sub-panel to add circuits to existing service. The main breaker protects the main entire panel and can be used as a service disconnect. The branch breakers protect the wires leading to individual electrical loads such as fixtures and outlets.

#### Features, Benefits and Functions

##### Loadcenter Construction

Eaton's Type BR loadcenters have standard tin-plated aluminum bus with a limited availability of copper bus. The sum of the handle ratings connected to any stab is limited to 150 A maximum on the 100 and 125 A loadcenters, and 200 A on loadcenters with 150 A or higher main bus. NEMA Type 1 boxes or enclosures are manufactured from galvanized steel. Raintight boxes are manufactured from galvanized steel, then finished using an electrostatic powder coat, baked urethane paint process.

##### Neutrals

Eaton Type CH loadcenters feature two types of neutrals:

##### Insulated/Bondable Split Neutral

Panels are supplied with split insulated neutrals with an insulated cross strap. For service entrance applications, the neutral must be bonded by using the bonding strap supplied with the panel. For non-service entrance (sub-panel) applications, the panel may be installed with the bonding strap not connected to the neutral. Separate ground bars must be used on non-service entrance panels.

##### Insulated/Bondable Single Neutral

Panels are supplied with a single insulated neutral. For service entrance applications, all that is required to bond the neutral is to loosen the bonding screw and the neutral screw directly beside it, insert the bonding strap into the neutral bar, and re-tighten both connections. The single neutral can be moved by the contractor to the other side of the panel, if desired. When used as a service entrance panel, unused neutral connections may be used for the termination of equipment grounds. For non-service entrance (sub-panel) applications, the panel may be installed with the bonding strap not connected to the neutral. Separate ground bars must be used on non-service entrance panels.

**Grounds**

In service entrance applications where the neutral is bonded, unused neutral holes may be used for terminating ground conductors. In sub-feed panels, the neutral must be isolated (non-bonded), and ground wires must be terminated on a separate ground bar.

The insulated/bondable single/split neutral panels have sufficient terminations for both ground and neutral conductors. The insulated/bondable single split neutral panels are supplied with a separate factory-installed ground bar if the catalog number contains a "G." If not, a separate ground bar should be installed. Insulated/Bondable Single Neutral panels are supplied without a ground bar (unless otherwise noted), and ground bar kits if needed must be purchased separately.

**Neutral and Ground Terminals**

The standard terminals on grounds and neutrals are rated to accept (3) #14–#10 Cu/Al or (1) #14–4, provided the cables terminated are of the same material. For larger cables, add-on neutral lugs may be ordered from the accessories on **Page V1-T1-71**.

**Note:** NEC allows only one current-carrying conductor per hole on neutrals unless otherwise noted.

**Bottom Fed Loadcenters**

For single-phase 225 A and below loadcenters that are bottom fed, a standard panel can be rotated 180 degrees to allow straight-in wiring of power cables to the main terminals. Because the main circuit breaker handle operates horizontally, the orientation of the main circuit breaker handle is consistent with the requirements of NEC 2008 Article 240.81.

**Gutter Splicing**

Loadcenters are not UL listed as wiring troughs. Therefore, gutter splicing of riser cables to tap off to the main device is not permitted. Refer to NEC 2008 Article 312.8.

**Fire Rating**

Due to the numerous openings in both loadcenter boxes and trims, they should not be mounted in firewalls. There is no approved method for sealing the enclosures for this application.

**Date Code**

The date of manufacture of each loadcenter is printed on the outside of the carton as well as inside the loadcenter. On the carton, the date code is printed on the end carton label. In the loadcenter, the date code is located on the small white label located on the right side wall (with the main device on top).

The date code is in the following format: F # # # &. The "F" is the numeric code for the Lincoln, IL plant, and the three numbers are the year and week of manufacturing, e.g., 023. The "!" sign at the end signifies the decade of the 2010. Therefore, the date code F023& would indicate that the product was manufactured in the 23rd week of 2010. The 1980s are represented by the "+" sign and the 1990s are represented by a "=" at the end of the code.

**Surge Protectors**

Complete home surge protection is available in multiple options, including a factory-installed option that provides the highest level of surge protection in a residential design. See Tab 3 for more details.

**Circuit Breaker Case Interrupting Capacity**

- 10 kAIC
- 22 kAIC
- 25 kAIC

**Warranty Information**

- 10-year limited loadcenter warranty
- 10-year limited branch breaker warranty

**Standards and Certifications****UL Listings**

All Eaton Type BR loadcenters are listed under UL File E52977 except the 2–8 circuit loadcenters, up through and including 125 A, which are listed under UL File E8741.



# 1.2

## Loadcenters and Circuit Breakers

### Type BR Loadcenters and Circuit Breakers

1

#### Type BR Loadcenter

Extra 1.5 inch Knockout (38.1 mm)

- Larger knockout provides easier installation and time savings

Top or Bottom Feed

- Straight-in wiring saves labor and material
- One panel for either top or bottom applications

2/0 Lug

- Easily removable and can be installed in any location on the neutral bar

Type BR AFCI Breakers

- Compact design for easier wiring and improved wireway access
- Optional LED indicates one of six trip codes for circuit diagnostics
- Provides a clean gutter space

Standard Tin-Plated Aluminum Bus

- Excellent conductivity and corrosion resistance
- Copper bus options available for select catalog numbers

Drywall Marking on Enclosure

- Indicates proper mounting depth for flush applications

"Tangential" Center Knockout

- Easier installation for conduit applications

Commercial Grade Main Breaker

- 25 kAIC series rated main breaker for superior protection

Neutral Bus (Strap)

- Is easily removable for sub-panel applications

Bonding Z-Strap

- Provides easy field conversion for service entrance applications

Twin Neutral Bars

- Minimum 150% neutral capacity

Steel Backpan

- Provides solid and reliable breaker mounting—single piece design for stability and durability

Single Keyhole Mounting

- One keyhole at the top and bottom provides easier mounting and leveling

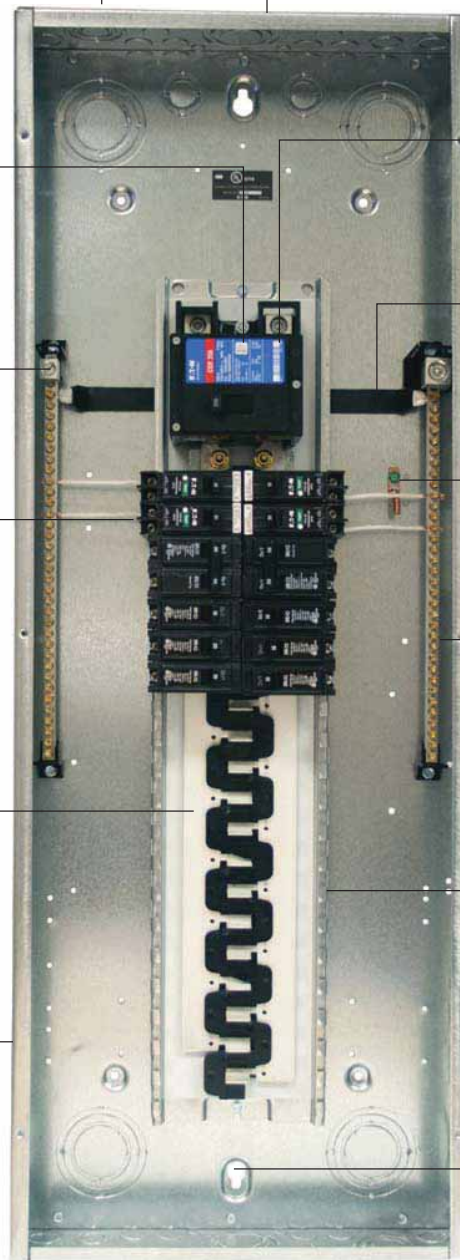

#### Warranty

10-year warranty on all Type BR loadcenters and circuit breakers.

### Catalog Number Selection

#### Single- and Three-Phase Through 600 A

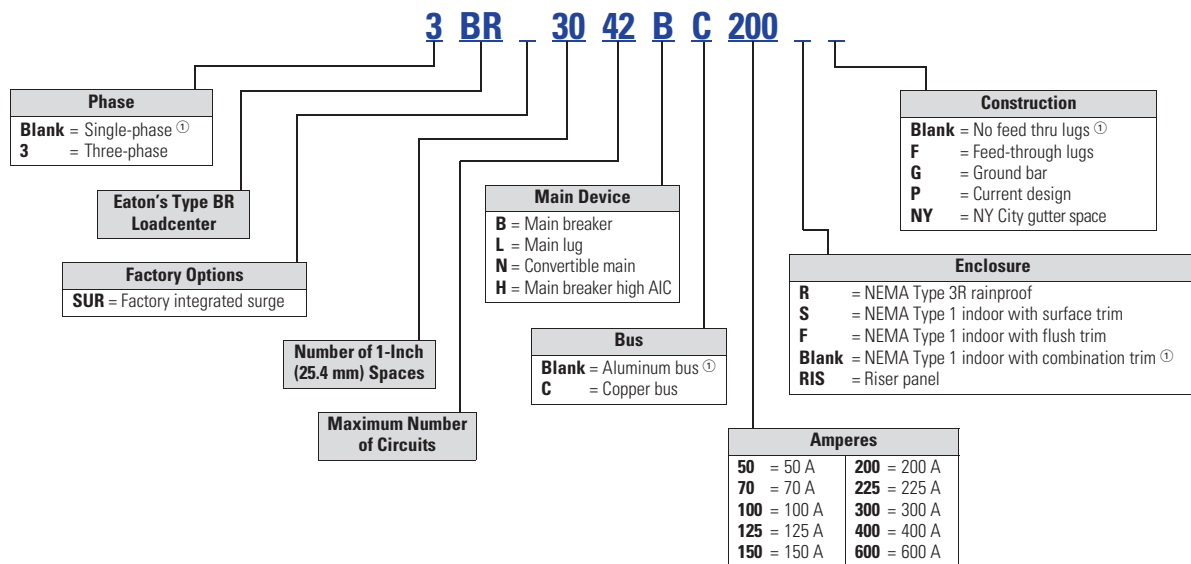

**Note**

① No character space used.

#### 1

#### Product Selection

##### Single-Phase—Main Circuit Breaker Loadcenters—10/25 kAIC

##### Single-Phase Three-Wire—120/240 Vac—Insulated/Bondable Split Neutral

Main Breaker Type	Main Ampere Rating	Maximum Number 1-Inch (25.4 mm)		Enclosure Type	Box Size	Wire Size Range Cu/Al 60 °C or 75 °C for Main Breaker	Loadcenter Catalog Number with Combination <sup>①</sup> or NEMA Type 3R Cover			
		Spaces	Circuits							
BR 10 kAIC	100	8	16	Indoor	B1	#4–1/0 <sup>②</sup>	BR816B100			
		10	20	Indoor	A1		BR1020B100S11			
		10	20	Indoor	A1		BR1020B100F11			
		10	20	Outdoor	B2R		BR1020B100RF <sup>③④</sup>			
		12	12	Indoor	B2		BR1212B100			
		12	20	Indoor	B2		BR1220B100			
		12	24	Outdoor	B2R		BR1224B100R <sup>④</sup>			
		16	16	Indoor	C1		BR1616B100			
		16	20	Indoor	C1		BR1620B100			
		16	24	Outdoor	C1R		BR1624B100R <sup>④</sup>			
		20	24	Outdoor	C3R		BR2024B100R <sup>④</sup>			
		20	20	Indoor	C2		BR2020B100			
		16	24	Indoor	C1		BR1624B100			
		30	30	Indoor	D1		BR3030B100			
			125	16	24		Indoor	C1	#4–2/0	BR1624B125
20	24			Indoor	C1	BR2024B125				
20	24			Outdoor	C3R	BR2024B125R <sup>④</sup>				
30	30			Indoor	D1	BR3030B125				
BRH <sup>⑤</sup> 22 kAIC	100	20	24	Indoor	C2	#4–1/0	BR2024H100 <sup>⑥</sup>			
CSR <sup>⑥</sup> 25 kAIC	150	8	16	Outdoor	C3R	#2–300 kcmil	BR816B150RF <sup>③④</sup>			
		16	30	Indoor	C4		BR1630B150			
		20	30	Indoor	C4		BR2030B150			
		20	30	Outdoor	D1R		BR2030B150R <sup>④</sup>			
		20	40	Indoor	D1		BR2040B150			
		20	40	Outdoor	D1R		BR2040B150R <sup>④</sup>			
		24	30	Indoor	G1		BR2430B150			
		30	30	Outdoor	G1R		BR3030B150R <sup>④</sup>			
		30	30	Indoor	G1		BR3030B150			
		30	40	Indoor	G1		BR3040B150			
			200	4	8		Outdoor	8R	#2–300 kcmil	BR48B200RF <sup>③⑦⑧</sup>
				8	16		Outdoor	C3R		BR816B200RF <sup>③④</sup>
16	32			Indoor	C4	BR1632B200				
20	40			Outdoor	D1R	BR2040B200R <sup>④</sup>				
20	40			Indoor	D1	BR2040B200				
24	40			Indoor	G1	BR2440B200				
30	40			Outdoor	G1R	BR3040B200R <sup>④</sup>				
40	40			Outdoor	L1R	BR4040B200R <sup>④</sup>				
60	120			Indoor	L3	BR60120B200				
	225	42	42	Indoor	L2	#1–250 kcmil	BR4242B225			
		42	42	Outdoor	L2R		BR4242B225R <sup>④</sup>			

#### Notes

- ① Combination style covers may be used in surface or flush applications.
- ② Wire range size for BR1020B100SP is #6–#1 Cu/Al.
- ③ Includes through-feed lugs for both phase and neutral conductors.
- ④ Rainproof panels are furnished with hub closure plates. For rainproof hubs, refer to **Page V1-T1-71**.
- ⑤ 22 kAIC series combination rating is obtained when Types BD, BR, BQ, BQC and GFTCB 10 kAIC branch breakers are used in series with Type BRH main breaker.
- ⑥ 25 kAIC series combination rating is obtained when Types BD, BR, BQ, BQC and GFTCB 10 kAIC branch circuit breakers are used in series with Type CSR main breaker.
- ⑦ Supplied with adapter plate to use DS Group1 hubs on **Page V1-T1-71**. If 2.50-inch (63.5 mm) hub is needed, remove adapter and use ARP00007CH25 hub.
- ⑧ Neutral is bonded—suitable for service entrance only—cannot be converted for sub-feed application.

All main circuit breaker loadcenters are listed for use as service entrance equipment and are shipped with neutral bonding strap preattached. The maximum rating of the panel is the main circuit breaker rating when used as service entrance equipment. Ground bar kits priced separately. See **Page V1-T1-71**.

### Main Circuit Breaker Loadcenters—10/22 kAIC

B4242DFN



### Single-Phase Three-Wire—120/240 Vac—Insulated/Bondable Split Neutral

Main Breaker Type	Main Ampere Rating	Maximum Number 1-Inch (25.4 mm)		Enclosure Type	Box Size	Wire Size Range Cu/Al 60 °C or 75 °C for Main Breaker	Commercial Loadcenter Catalog Number <sup>①②③</sup>	
		Spaces	Circuits				With Flush or NEMA Type 3R Cover	With Surface Cover
DK <sup>④</sup>	300	42	42	Indoor	24	(2) #3/0–250 kcmil	BR4242B300F	BR4242B300S
	400	42	42	Indoor	24	(2) #3/0–250 kcmil	BR4242B400F	BR4242B400S
		42	42	Outdoor	47	(2) #3/0–250 kcmil	BR4242B400R <sup>⑤</sup>	—
HLD <sup>⑥</sup>	600	42	42	Indoor	24	(2) #3/0–500 kcmil	—	BR4242B600S

#### Notes

- ① Ground bar kits priced separately. See **Page V1-T1-71**.
- ② The maximum rating of the panel is the main circuit breaker rating when used as service entrance equipment.
- ③ Door lock and key included with loadcenter.
- ④ Type DK main circuit breaker is rated 65 kAIC at 240 Vac and allows a 22 kAIC series rating on the panel when Types BR, BD and BJ branch circuit breakers are used.
- ⑤ Rainproof panels are furnished with hub closure plates. For rainproof hubs, refer to **Page V1-T1-71**.
- ⑥ Type HLD main circuit breaker is rated 65 kAIC at 240 Vac. Type HLD circuit breaker **is not** series rated with Types BR, BD and BJ branch circuit breakers.

Box sizes **Pages V1-T1-76 through V1-T1-79**.

Please contact the Lincoln Flex Center for any configurations not listed.



#### Single-Phase—Main Lug Loadcenters

#### Single-Phase Three-Wire—120/240 Vac—Insulated/Bondable Split Neutral

Main Ampere Rating	Maximum Number 1-Inch (25.4 mm)		Enclosure Type	Trim Type	Box Size	Wire Size Range Cu/Al 60 °C or 75 °C for Main Lugs	Loadcenter Catalog Number
	Spaces	Circuits					
70	Surface	Outdoor	Indoor	Surface (no door)	5	#8-#2	BR24L70SP ①②
			Indoor	Surface (no door)	5		BR24L70SGP ②③
	Outdoor	—	5R	BR24L70RP ①②④			
	Indoor	Flush (no door)	5	BR24L70FP ①②			
	Indoor	Flush (no door)	5	BR24L70FGP ②⑤			
125	Flush	Outdoor	Indoor	Surface (no door)	6	#14-1/0	BR24L125SP ①②
			Outdoor	—	6R		BR24L125RP ①②④
	Surface (No Door)	Outdoor	Indoor	Surface (no door)	6	#14-1/0	BR24L125RSEP ②⑦⑧
			Indoor	Surface (no door)	6		BR24L125RSE2P ②⑥⑦
	Flush (No Door)	Outdoor	Indoor	Flush (no door)	6	#14-1/0	BR24L125FFP ①②
			Indoor	Surface (no door)	7		BR48L125SP ①⑨
			Indoor	Surface (no door)	7		BR48L125SGP ③⑨
			Outdoor	—	7R		BR48L125RP ①④⑨
			Indoor	Flush (no door)	7		BR48L125FFP ①⑨
			Indoor	Flush (with door)	7		BR48L125FDP ①⑨
			Indoor	Flush (no door)	7		BR48L125FGP ③⑨
			Indoor	Surface (no door)	7		#14-#1
	Outdoor	Outdoor	Indoor	Surface (no door)	7	#14-#1	BR612L125SGP ⑩⑪
			Indoor	Surface (with door)	7		BR612L125SDP ①⑩
			Indoor	Surface (with door)	7		BR612L125SDGP ⑩⑪
			Outdoor	—	7R		BR612L125RP ①④⑩
			Indoor	Flush (no door)	7		BR612L125FFP ①⑩
			Indoor	Flush (no door)	7		BR612L125FGP ⑤⑩⑪
			Indoor	Flush (with door)	7		BR612L125FDP ⑩
			Indoor	Flush (with door)	7		BR612L125FDGP ⑤⑩⑪
Indoor			Surface (no door)	7	#14-#1		BR816L125SP ①⑩
Indoor			Surface (no door)	7			BR816L125SGP ⑩⑫
Indoor			Surface (with door)	7			BR816L125SDP ①⑩
Indoor			Surface (with door)	7			BR816L125SDGP ⑩⑫
Outdoor	—	7R	BR816L125RP ①④⑩				
Indoor	Flush (no door)	7	BR816L125FFP ①⑩				
Indoor	Flush (no door)	7	BR816L125FGP ⑤⑩⑫				
Indoor	Flush (with door)	7	BR816L125FDP ①⑩				
Indoor	Flush (with door)	7	BR816L125FDGP ⑤⑩⑪				



#### Notes

- ① Ground bar kits priced separately. See **Page V1-T1-71**.
  - For 2/4 circuit loadcenters, use GBK5 or GBK520 ground bar.
  - For 4/8, 6/12 and 8/16 circuit loadcenters, use GBK10 ground bar.
  - Ground bars mount to the left side wall of the enclosure for the 4/8, 6/12 and 8/16 circuit loadcenters.
- ② Suitable for use as service equipment when not more than two service disconnecting mains are provided or when not used as a lighting and appliance panelboard.
- ③ Ground bar GBK5 is installed.
- ④ Rainproof panels are furnished with hub closure plates. For rainproof hubs, refer to **Page V1-T1-71**.
- ⑤ CSA and UL approved.
- ⑥ Neutral/ground holes (6) #14-6 and (3) #14-2/0 AWG Cu/Al.
- ⑦ For use as service entrance applications only.
- ⑧ Neutral/ground holes (6) #14-6 and (3) #14-1/0 AWG Cu/Al.
- ⑨ Suitable for use as service equipment when not more than two service disconnecting mains are provided or when not more than six service disconnecting mains are provided and when not used as a lighting and appliance panelboard.
- ⑩ Suitable for use as service equipment when a main breaker is used or when not more than six service disconnecting mains are provided and when not used as a lighting and appliance panelboard.
- ⑪ Ground bar GBK10 is installed.
- ⑫ Ground bar GBK14 is installed.

Box sizes **Pages V1-T1-76** through **V1-T1-79**.

### Single-Phase—Main Lug Loadcenters

#### Single-Phase Three-Wire—120/240 Vac—Insulated/Bondable Split Neutral, continued

Main Ampere Rating	Maximum Number 1-Inch (25.4 mm)		Enclosure Type	Box Size	Wire Size Range Cu/Al 60 °C or 75 °C for Main Lugs	Loadcenter Catalog Number with Combination or NEMA Type 3R Cover ①			
	Spaces	Circuits							
BR1224L125 	125	12	12	Indoor	#6–2/0	BR1212L125 ②③④⑤			
		12	24	Indoor		B1	BR1224L125 ②④⑤		
		12	24	Indoor		B1	BR1224L125G ②④⑤		
		12	24	Indoor		B1	BR1224L125DG ②④⑤⑥		
		12	24	Outdoor		B1R	BR1224L125R ②⑤⑦		
		16	16	Indoor		B2	BR1616L125 ②④⑤		
		16	24	Indoor		B2	BR1624L125 ②④		
		16	24	Indoor		B2	BR1624L125G ②④		
		16	24	Outdoor		B2R	BR1624L125R ②⑦		
		20	20	Indoor		C1	BR2020L125 ②④⑤		
		20	24	Indoor		C1	BR2024L125 ②④		
		20	24	Indoor		C1	BR2024L125G ②④⑧		
		20	24	Outdoor		C1R	BR2024L125R ③⑦		
		24	24	Indoor		C2	BR2424L125 ②④		
		24	24	Indoor		C2	BR2424L125G ②④⑧		
		30	42	Indoor		D1	BR3042L125 ②④		
		150	16	30		Indoor	C2	#1–300 kcmil	BR1630L150 ④⑨
			20	30		Indoor	C2		BR2030L150 ④⑨
		BR1224L200 	200	8		16	Outdoor	#1–300 kcmil	BR816L200RF ⑤⑦⑩
12	24			Indoor	B2	BR1224L200 ④⑤⑨			
12	24			Outdoor	B2R	BR1224L200R ⑤⑦⑨			
20	40			Indoor	C2	BR2040L200 ④⑨			
20	40			Indoor	C2	BR2040L200G ④⑧⑨			
20	40			Outdoor	C3R	BR2040L200R ⑦⑨			
24	40			Indoor	C4	BR2440L200 ④⑨			
30	40			Indoor	D1	BR3040L200 ④⑨			
30	40			Outdoor	D1R	BR3040L200R ⑦⑨			
40	40			Indoor	G1	BR4040L200 ④⑨			
40	40			Indoor	G1	BR4040L200G ④⑨			
40	40			Outdoor	G1R	BR4040L200R ⑦⑨			
60	120			Indoor	L3	BR60120L200 ⑩			
225	42			42	Indoor	L1	#1–300 kcmil		BR4242L225 ④
	42			42	Outdoor	L1R			BR4242L225R ⑦

#### Notes

- ① Ground bar kits priced separately unless otherwise noted. See **Page V1-T1-71**.
- ② Has notch for BREQS125 hold-down kit.
- ③ Single, movable neutral is provided.
- ④ Combination cover style.
- ⑤ Suitable for use as service equipment when not more than six main disconnecting means are provided and when not used as a lighting and appliance panelboard.
- ⑥ Ground bars GBK5 and GBK520 installed.
- ⑦ Rainproof panels are furnished with hub closure plates. For rainproof hubs, refer to **Page V1-T1-71**.
- ⑧ Ground bar GBK1220 installed.
- ⑨ Has notch for BRHDK125 hold-down kit.
- ⑩ Includes through-feed lugs for both phase and neutral conductors.
- ⑪ Includes main lugs. Loadcenters can convert to main breaker using kit.

# 1.2

## Loadcenters and Circuit Breakers

### Type BR Loadcenters and Circuit Breakers

1

#### Single-Phase—Main Lug Loadcenters—400 and 600 A

4242DFN



#### Single-Phase Three-Wire—120/240 Vac—Insulated/Bondable Split Neutral

Main Ampere Rating	Maximum Number 1-Inch (25.4 mm)		Enclosure Type	Box Size	Wire Size Range Cu/Al 60 °C or 75 °C for Main Lugs	Commercial Loadcenter Catalog Number <sup>①②③</sup>	
	Spaces	Circuits				With Flush or NEMA Type 3R Cover	With Surface Cover
400	12	24	Outdoor	42	(2) #3/0–400 kcmil	BR1224L400R <sup>④⑤</sup>	—
	42	42	Indoor	22		BR4242L400F	BR4242L400S
	42	42	Outdoor	46		BR4242L400R <sup>④</sup>	—
600	42	42	Indoor	22	(2) #2–500 kcmil	—	BR4242L600S

#### Notes

- ① Ground bar kits priced separately unless otherwise noted. See **Page V1-T1-71**.
- ② Has notch for BRHDK125 hold-down kit.
- ③ Ground bar GBK8 installed.
- ④ Rainproof panels are furnished with hub closure plates. For rainproof hubs, refer to **Page V1-T1-71**.
- ⑤ Suitable for use as service equipment when not more than six main disconnecting means are provided and when not used as a lighting and appliance panelboard.

**Convertible Loadcenters MCB or MLO—Base Units and Main Devices 10/22/25 kAIC, Complete Assembly Consists of: Loadcenter and Either Main Breaker Kit or Main Lug Kit**

**Note:** Interrupting rating depends on main circuit breaker selected.

BR3040N200



**Base Units—Single-Phase Three-Wire—120/240 Vac—Insulated/Bondable Split Neutral (Unless Otherwise Noted)**

Main Ampere Rating <sup>①</sup>	Maximum Number 1-Inch (25.4 mm)		Enclosure Type	Box Size	Wire Size Range Cu/Al 60 °C or 75 °C for Main	Loadcenter Catalog Number With Combination or NEMA Type 3R Cover <sup>②③</sup>
	Spaces	Circuits				
125 <sup>④</sup>	12	24	Indoor	B2	See main breaker and main lug kit tables <b>Page V1-T1-54.</b>	BR1224N125 <sup>⑤⑥</sup>
	12	24	Outdoor	B2R		BR1224N125R <sup>⑤⑥⑦</sup>
	16	24	Indoor	C1		BR1624N125 <sup>⑤</sup>
	16	24	Outdoor	C1R		BR1624N125R <sup>⑤⑦</sup>
	20	24	Indoor	C2		BR2024N125 <sup>⑤</sup>
	20	24	Outdoor	C3R		BR2024N125R <sup>⑤⑦</sup>
200 <sup>⑧</sup>	8	16	Outdoor	C3R	BR816N200RF <sup>⑦⑧⑩⑪</sup>	
	12	24	Indoor	C4	BR1224N200 <sup>⑩</sup>	
	12	24	Outdoor	C3R	BR1224N200R <sup>⑦⑩</sup>	
	16	32	Indoor	C4	BR1632N200 <sup>⑩</sup>	
	20	40	Indoor	D1	BR2040N200 <sup>⑩</sup>	
	20	40	Indoor	D1	BR2040N200G <sup>⑫</sup>	
	20	40	Outdoor	D1R	BR2040N200R <sup>⑦⑩</sup>	
	20	40	Outdoor	D1R	BR2040N200RG <sup>⑫</sup>	
	24	40	Indoor	G1	BR2440N200 <sup>⑦⑩</sup>	
	30	40	Indoor	G1	BR3040N200 <sup>⑩</sup>	
	30	40	Indoor	G1	BR3040N200G <sup>⑫</sup>	
	30	40	Outdoor	G1R	BR3040N200R <sup>⑦⑩</sup>	
	30	40	Outdoor	G1R	BR3040N200RG <sup>⑫</sup>	
	40	40	Indoor	L1	BR4040N200G <sup>⑫</sup>	
	40	40	Outdoor	L1R	BR4040N200R <sup>⑦⑩</sup>	
	40	40	Outdoor	L1R	BR4040N200RG <sup>⑫</sup>	
40	50	Indoor	L1	BR4050N200		
40	50	Outdoor	L1R	BR4050N200R		

**Notes**

- ① The maximum rating of the loadcenter is the main circuit breaker rating when used as service entrance equipment.
- ② 100, 125 and 200 A convertible base unit catalog numbers include interior, box and cover only. Main devices and accessories must be ordered separately for field installation. All convertible base units are listed as suitable for use as service entrance equipment when used per Article 408 of the NEC.
- ③ Ground bar kits priced separately except as noted, refer to **Page V1-T1-71.**
- ④ For main breaker, use Type BR. For main lug use Type BRSF.
- ⑤ BREQS125 hold-down screw comes with loadcenter for back-fed Types BR and BRH main circuit breakers.
- ⑥ Convertible to maximum of 100 A main circuit breaker and 125 A main lug.
- ⑦ Rainproof loadcenters are furnished with hub closure plates. For rainproof hubs, refer to **Page V1-T1-71.**
- ⑧ For main breaker, use Type BW or CSR. For main lug, use Type BRL.
- ⑨ Includes through-feed lugs for both phase and neutral conductors.
- ⑩ No hold-down provisions for back-fed Types BR and BRH main circuit breakers.
- ⑪ Insulated/bondable single neutral.
- ⑫ Includes GBK2120 ground bar.

# 1.2

## Loadcenters and Circuit Breakers

### Type BR Loadcenters and Circuit Breakers

1

#### Convertible Loadcenters MCB or MLO—Base Units and Main Devices 10/22/25 kAIC, Complete Assembly Consists of: Loadcenter and Either Main Breaker Kit or Main Lug Kit

**Note:** Interrupting rating depends on main circuit breaker selected.

#### BW2200



#### Main Devices—Two- and Three-Pole Main Circuit Breakers—120/240 Vac or 208Y/120 Vac or 240 Vac

Ampere Rating	Wire Size Range Cu/Al 60 °C or 75 °C for Main Breaker	10 kAIC Catalog Number	22/25 kAIC Catalog Number ①
<b>Two-Pole</b>			
100	#4–1/0	BR2100	BRH2100
110	#4–1/0	BR2110	BRH2110
125	#4–2/0	BR2125	BRH2125
125	#2–300 kcmil	BW2125	CSR2125N
150	#2–300 kcmil	BW2150	CSR2150N
175	#2–300 kcmil	BW2175	CSR2175N
200	#2–300 kcmil	BW2200	CSR2200N
<b>Three-Pole</b>			
100	#1	BR3100	BRH3100

#### BRL200



#### Main Devices—Two- and Three-Pole Main Lug Kits—120/240 Vac or 208Y/120 Vac or 240 Vac

Ampere Rating	Wire Size Range Cu/Al 60 °C or 75 °C for Main Lugs	Catalog Number
<b>Two-Pole</b>		
125	#6–2/0	BRSF125
150	#1–300 kcmil	BRL200
175	#1–300 kcmil	BRL200
200	#1–300 kcmil	BRL200
<b>Three-Pole</b>		
150	#6–3/0	3BRSF150

#### Main Circuit Breaker with Accessory

Example: BW22005R01 (Put description with catalog number on order. See **Page V1-T1-90**.)

#### Main Circuit Breaker Loadcenters—Copper Bus 10/22/25 kAIC

#### BR3030BC100



#### Main Circuit Breaker Loadcenters—With Copper Bus—Single-Phase Three-Wire—120/240 Vac—Insulated/Bondable Split Neutral

Main Breaker Type	Main Ampere Rating	Maximum Number 1-Inch (25.4 mm)		Enclosure Type	Box Size	Wire Size Range Cu/Al 60 °C or 75 °C for Main Breaker	Loadcenter Catalog Number with Combination Cover ②③
		Spaces	Circuits				
BR 10 kAIC	100	20	20	Indoor	C2	#4–1/0	BR2020BC100
		30	30	Indoor	D1	#4–1/0	BR3030BC100
BRH 22 kAIC ④	100	30	30	Indoor	D1	#4–1/0	BR3030HC100
		150		30	30	Indoor	G1
CSR 25 kAIC	200	20	40	Indoor	D1	#2–300 kcmil	BR2040BC200
		30	40	Indoor	G1	#2–300 kcmil	BR3040BC200
		40	40	Indoor	L1	#2–300 kcmil	BR4040BC200

#### Main Lug Only Loadcenters—Copper Bus

#### BR816LC125FDP



#### Single-Phase Three-Wire—120/240 Vac—Insulated/Bondable Single Neutral with Copper Bus

Main Ampere Rating	Maximum Number 1-Inch (25.4 mm)		Enclosure Type	Trim Type	Box Size	Wire Size Range Cu/Al 60 °C or 75 °C for Main Lugs	Loadcenter Catalog Number
	Spaces	Circuits					
125	8	16	Indoor	Surface (with door)	7	#14–1	BR816LC125SDP
	8	16	Indoor	Flush (with door)	7		BR816LC125FDP

#### Notes

- ① Series combination rating with Types BD, BR, BQ, BQC and GFTCB is 22 kAIC with BRH main and 25 kAIC with CSR main.
  - ② All main circuit breaker loadcenters are listed for use as service entrance equipment and are shipped with neutral bonding strap preattached. The maximum rating of the panel is the main circuit breaker rating when used as service entrance equipment.
  - ③ Ground bar kits priced separately. See **Page V1-T1-71**.
  - ④ 22 kAIC series combination rating is obtained when Types BD, BR, BQ, BQC and GFTCB 10 kAIC branch breakers are used in series with Type BRH main breaker.
- Box sizes **Pages V1-T1-76** through **V1-T1-79**.

### Convertible Loadcenters—Copper Bus 10/22/25 kAIC

BR3040NC200



### Convertible—Single-Phase, Three-Wire—120/240 Vac—Insulated/Bondable Split Neutral

Main Ampere Rating	Maximum Number 1-Inch (25.4 mm)		Enclosure Type	Box Size	Wire Size Range Cu/Al 60 °C or 75 °C for Main	Loadcenter Catalog Number (With Combination or NEMA Type 3R Cover) ①②③
	Spaces	Circuits				
125 10/22 kAIC ④⑤	12	24	Indoor	B2	See main breaker and main lug kit tables on <b>Page V1-T1-54</b> .	<b>BR1224NC125</b> ⑥⑦
	12	24	Outdoor	B2R		<b>BR1224NC125R</b> ⑥⑦⑧
	20	24	Indoor	C2		<b>BR2024NC125</b> ⑦
	20	24	Outdoor	C3R		<b>BR2024NC125R</b> ⑦⑧
200 10/25 kAIC ④⑤	20	40	Indoor	D1	<b>BR2040NC200</b>	
	20	40	Outdoor	D1R	<b>BR2040NC200R</b> ⑧	
	30	40	Indoor	G1	<b>BR3040NC200</b>	
	30	40	Outdoor	G1R	<b>BR3040NC200R</b> ⑧	
	40	40	Indoor	L1	<b>BR4040NC200</b>	
	40	40	Outdoor	L1R	<b>BR4040NC200R</b> ⑧	

#### Notes

- ① 100, 125 and 200 A convertible base unit catalog numbers include interior, box and cover only. Main devices and accessories must be ordered separately for field installation. All convertible base units are listed as suitable for use as service entrance equipment when used per Article 384 of the NEC.
- ② Ground bar kits priced separately, refer to **Page V1-T1-71**.
- ③ All main circuit breaker loadcenters are listed for use as service entrance equipment and are shipped with a neutral bonding strap preattached. The maximum main rating of the loadcenter is the main breaker rating when used as service entrance equipment.
- ④ Interrupting rating depends on main circuit breaker selected. See **Page V1-T1-71** for mains.
- ⑤ For main breaker, use Type BW or CSR. For main lug, use Type BRL.
- ⑥ Rainproof loadcenters are furnished with hub closure plates. For rainproof hubs, refer to **Page V1-T1-71**.
- ⑦ Hold-down screw BREQS125 comes with loadcenter for back-fed Types BR and BRH main circuit breakers.
- ⑧ For main breaker, use Type BR. For main lug, use Type BRSF.
- ⑨ Suitable for use as service equipment when not more than six main disconnecting means are provided and when not used as a lighting and appliance panelboard.

#### 1 Three-Phase—Type BR Main Circuit Breaker Loadcenters

#### Three-Phase, Four-Wire—Main Lug Loadcenters—Copper Bus—208Y/120 Vac or 240 Vac, Insulated/Bondable Split Neutral

Main Ampere Rating	Maximum Number 1-Inch (25.4 mm)		Enclosure Type	Box Size	Wire Size Range Cu/Al 60 °C or 75 °C for Main	Loadcenter Catalog Number (With Combination or NEMA Type 3R Cover)
	Spaces	Circuits				
125	12	24	Indoor	C1	#6–3/0	3BR1224LC125
125	12	24	Outdoor	C1R	#6–3/0	3BR1224LC125R
150	24	42	Indoor	D1	#4–300 kcmil	3BR2442LC150
150	24	42	Outdoor	D1R	#4–300 kcmil	3BR2442LC150R
200	12	24	Indoor	C4	#4–300 kcmil	3BR1224LC200
200	12	24	Outdoor	C3R	#4–300 kcmil	3BR1224LC200R
200	30	42	Indoor	G1	#4–300 kcmil	3BR3042LC200
200	30	42	Outdoor	G1R	#4–300 kcmil	3BR3042LC200R
200	42	42	Indoor	L1	#4–300 kcmil	3BR4242LC200
200	42	42	Outdoor	L1R	#4–300 kcmil	3BR4242LC200R
225	30	42	Indoor	L1	#4–300 kcmil	3BR3042LC225
225	30	42	Outdoor	L1R	#4–300 kcmil	3BR3042LC225R
400	42	42	Indoor	24	(2) 3/0–250 kcmil	3BR4242LC400S
	42	42	Outdoor	47		3BR4242BC400R
600	42	42	Indoor	24	(2) 3/0–500 kcmil	3BR4242LC600S

#### Three-Phase, Four-Wire—Main Circuit Breaker Loadcenters—Copper Bus—208Y/120 Vac or 240 Vac, Insulated/Bondable Split Neutral

Main Breaker Type	Main Ampere Rating	Maximum Number 1-Inch (25.4 mm)		Enclosure Type	Box Size	Wire Size Range Cu/Al 60 °C or 75 °C for Main Breaker	Loadcenter Catalog Number (With Combination or NEMA Type 3R Cover)
		Spaces	Circuits				
BR 10 kAIC	100	12	24	Indoor	C1	#14–1/0	3BR1224BC100
	100	12	24	Outdoor	C1R	#14–1/0	3BR1224BC100R
CC 10 kAIC	150	30	42	Indoor	L1	#6–4/0	3BR3042BC150
	150	30	42	Outdoor	L1R	#6–4/0	3BR3042BC150R
	200	42	42	Indoor	L2	2/0–300 kcmil	3BR4242BC200
	200	42	42	Outdoor	L2R	2/0–300 kcmil	3BR4242BC200R
	225	42	42	Indoor	L2	2/0–300 kcmil	3BR4242BC225
	225	42	42	Outdoor	L2R	2/0–300 kcmil	3BR4242BC225R
DK 22 kAIC	400	42	42	Indoor	24	(2) 3/0–250 kcmil	3BR4242BC400S
		42	42	Outdoor	47		3BR4242BC400R
HLD 10 kAIC	600	42	42	Indoor	24	(2) 3/0–500 kcmil	3BR4242BC600S

3BR4242B200



#### Three-Phase, Four-Wire—Main Circuit Breaker Loadcenters—Aluminum Bus—208Y/120 Vac or 240 Vac Insulated/Bondable Split Neutral

Main Breaker Type	Main Ampere Rating	Maximum Number 1-Inch (25.4 mm)		Enclosure Type	Box Size	Wire Size Range Cu/Al 60 °C or 75 °C for Main Breaker	Loadcenter Catalog Number <sup>(1)(2)</sup> (With Combination or NEMA Type 3R Cover)	
		Spaces	Circuits					
BR 10 kAIC	100	12	24	Indoor	C1	#14–1/0	3BR1224B100	
			12	24	Outdoor	C1R		3BR1224B100R <sup>(3)</sup>
CC 10 kAIC	125	30	42	Indoor	L1	#6–4/0	3BR3042B125	
	150	30	42	Indoor	L1	#6–4/0	3BR3042B150	
		30	42	Outdoor	L1R			3BR3042B150R <sup>(3)</sup>
	200	30	42	Indoor	L1	#1–250 kcmil	3BR3042B200	
		30	42	Outdoor	L1R			3BR3042B200R <sup>(3)</sup>
		42	42	Indoor	L2			3BR4242B200
	42	42	Outdoor	L2R			3BR4242B200R <sup>(3)</sup>	
CHH 100 kAIC	200	42	42	Indoor	L2	2/0–300 kcmil	3BR4242H200 <sup>(6)</sup>	
CC 10 kAIC	225	42	42	Indoor	L2	2/0–300 kcmil	3BR4242B225	
		42	42	Outdoor	L2R			3BR4242B225R <sup>(3)</sup>
DK <sup>(4)</sup> 22 kAIC	400	42	42	Indoor	24	(2) #3/0–250 kcmil	3BR4242B400S <sup>(7)</sup>	
		42	42	Indoor	24		3BR4242B400F	
		42	42	Outdoor	47			3BR4242B400R <sup>(3)</sup>
LD <sup>(5)</sup>	600	42	42	Indoor	24	(2) #3/0–500 kcmil	3BR4242B600F	

#### Notes

- <sup>(1)</sup> All main circuit breaker loadcenters are listed for use as service entrance equipment and are shipped with a neutral bonding strap pre-attached (commercial loadcenters do not have a pre-attached bonding strip). The maximum main rating of the panel is the main circuit breaker rating when used as service entrance equipment.
- <sup>(2)</sup> Ground bar kits priced separately. See **Page V1-T1-71**.
- <sup>(3)</sup> Rainproof loadcenters are furnished with hub closure plates. For rainproof hubs, refer to **Page V1-T1-71**.
- <sup>(4)</sup> Type DK main circuit breaker is rated 65 kAIC at 240 Vac and allows a 22 kAIC series rating on the loadcenter when Types BR, BD and BJ branch circuit breakers are used.
- <sup>(5)</sup> The LD main circuit breaker is rated 65 kAIC at 240 Vac. Type LD circuit breaker **is not** series rated with Types BR, BD and BJ branch circuit breakers.
- <sup>(6)</sup> Includes CHH 100 kAIC rated MCB. 100 kAIC series rating combination is obtained when types BD, BR, BQ, BQC and GFGB branch breakers are used with CHH main.
- <sup>(7)</sup> With surface cover.

### 3BR1224L125



### Three-Phase, Four-Wire—Main Lug Loadcenters—Aluminum Bus—208Y/120 Vac or 240 Vac, Insulated/Bondable (Unless Otherwise Noted)

Main Ampere Rating	Maximum Number 1-Inch (25.4 mm)		Enclosure Type	Box Size	Wire Size Range Cu/Al 60 °C or 75 °C for Main Lugs	Loadcenter Catalog Number <sup>①</sup> (With Combination or NEMA Type 3R Cover)
	Spaces	Circuits				
100	3	3	Indoor	6	#6-1/0	3BR3L100S <sup>②③</sup>
	3	3	Outdoor	6R		3BR3L100R <sup>③④</sup>
125	12	24	Indoor	C1	#6-3/0	3BR1224L125 <sup>⑤⑥</sup>
	12	24	Outdoor	C1R		3BR1224L125R <sup>④⑤⑥</sup>
150	18	36	Indoor	C2	#6-4/0	3BR1836L150
	18	36	Outdoor	C3R		3BR1836L150R
	24	42	Indoor	D1	#4-300 kcmil	3BR2442L150
	24	42	Outdoor	D1R		3BR2442L150R <sup>④</sup>
200	12	24	Indoor	C4	#4-300 kcmil	3BR1224L200 <sup>⑥</sup>
	12	24	Outdoor	C3R		3BR1224L200R <sup>④⑥</sup>
	18	36	Indoor	C4	#4-300 kcmil	3BR1836L200
	18	36	Outdoor	C3R		3BR1836L200R
	30	42	Indoor	G1	#4-300 kcmil	3BR3042L200
	30	42	Outdoor	G1R		3BR3042L200R <sup>④</sup>
	42	42	Indoor	L1	#4-300 kcmil	3BR4242L200
	42	42	Outdoor	L1R		3BR4242L200R <sup>④</sup>
225	42	42	Indoor	L1	#4-300 kcmil	3BR4242L225
	42	42	Outdoor	L1R		3BR4242L225R <sup>④</sup>

### 3BR4242L400F



### Three-Phase, Four-Wire—Main Lug Loadcenters—Aluminum Bus—208Y/120 Vac or 240 Vac, Insulated/Bondable Split Neutral

Main Ampere Rating	Maximum Number 1-Inch (25.4 mm)		Enclosure Type	Box Size	Wire Size Range Cu/Al 60 °C or 75 °C for Main Lugs	Commercial Loadcenter Catalog Number <sup>⑦</sup>	
	Spaces	Circuits				With Flush or NEMA Type 3R Cover	With Surface Cover
400	42	42	Indoor	22	(1) 250-750 kcmil	3BR4242L400F	3BR4242L400S
	42	42	Outdoor	46	or (2) #3/0-250 kcmil	3BR4242L400R <sup>④</sup>	—
600	42	42	Indoor	22	(2) #2-500 kcmil	—	3BR4242L600S

#### Notes

- ① Ground bar kits priced separately. See **Page V1-T1-71**.
- ② Surface cover only.
- ③ Insulated/bondable single neutral.
- ④ Rainproof loadcenters are furnished with hub closure plates. For rainproof hubs, refer to **Page V1-T1-71**.
- ⑤ Has notch for BREQS125 hold-down kit.
- ⑥ Suitable for use as service equipment when not more than six main disconnecting means are provided and when not used as a lighting and appliance panelboard.
- ⑦ Door lock and key included with loadcenter.

Box sizes **Pages V1-T1-76** through **V1-T1-79**.



# 1.2

## Loadcenters and Circuit Breakers

### Type BR Loadcenters and Circuit Breakers

1

3BR3030N100



3BR4242N225NY



### Three-Phase, Four-Wire—Convertible Loadcenters—Aluminum Bus—208Y/120 Vac or 240 Vac, Insulated/Bondable Split Neutral

Main Ampere Rating <sup>①</sup>	Maximum Number 1-Inch (25.4 mm)		Enclosure Type	Box Size	Wire Size Range Cu/Al 60 °C or 75 °C for Main	Loadcenter Catalog Number <sup>②③</sup> (With Combination or NEMA Type 3R Cover)
	Spaces	Circuits				
100 <sup>④</sup>	30	30	Indoor	D1	See main breaker and main lug kit tables below.	3BR3030N100 <sup>⑤</sup>
	30	30	Outdoor	D1R		3BR3030N100R <sup>⑤⑥</sup>
125 <sup>④</sup>	12	24	Indoor	C1		3BR1224N125 <sup>⑤⑥⑦</sup>
	12	24	Outdoor	C1R		3BR1224N125R <sup>⑤⑥⑦⑧</sup>
200	30	42	Indoor	L1		3BR3042N200
225	42	42	Indoor	L2		3BR4242N225
	42	42	Indoor	B		3BR4242B225NY <sup>⑨</sup>

#### Notes

- ① The maximum rating of the loadcenter is the main circuit breaker rating when used as service entrance equipment.
- ② 100, 125 and 200 A convertible base unit catalog numbers include interior, box and cover only. Main devices and accessories must be ordered separately for field installation.  
All convertible base units are listed as suitable for use as service entrance equipment when used per Article 384 of the NEC.
- ③ Ground bar kits priced separately. See **Page V1-T1-71**.
- ④ For main breaker, use Type BR. For main lug, use Type BRSF.
- ⑤ BREQS125 hold-down screw comes with loadcenter for back-fed Types BR and BRH main circuit breakers.
- ⑥ Rainproof loadcenters are furnished with hub closure plates. For rainproof hubs, refer to **Page V1-T1-71**.
- ⑦ Convertible to maximum of 100 A main circuit breaker and 125 A main lug.
- ⑧ Suitable for use as service equipment when not more than six main disconnecting means are provided and when not used as a lighting and appliance panelboard.
- ⑨ Order 3BR42FTNY or 3BR42STNY cover separately.

Box sizes **Pages V1-T1-76 through V1-T1-79**.

**BR Plug-On Neutral Loadcenters**



### Contents

<b>Description</b>	<b>Page</b>
Overview .....	<b>V1-T1-42</b>
BR Specialty Products	
BR Plug-On Neutral Loadcenters	
Catalog Number Selection .....	<b>V1-T1-58</b>
Product Selection .....	<b>V1-T1-59</b>
BR Quick Connect Neutral Loadcenters .....	<b>V1-T1-60</b>
Spa Panels .....	<b>V1-T1-61</b>
Riser Panel .....	<b>V1-T1-62</b>
Type BR Renovation Loadcenter .....	<b>V1-T1-63</b>
BR Loadcenter Options and Accessories .....	<b>V1-T1-66</b>
BR Circuit Breakers .....	<b>V1-T1-80</b>

## BR Specialty Products

### BR Plug-On Neutral Loadcenters

#### Product Description

Quicker, easier and cleaner than the competition. Introducing the BR Plug-On Neutral portfolio from Eaton. Eaton's latest development in loadcenters and breakers has been redesigned to improve safety and ease of installation time, while offering a more professional look and feel.

#### Features and Benefits

- Redesigned the BR electronic breakers into a short-body to optimize gutter space and save time with an easier, more succinct installation process
- Unique self-leveling tabs to allow for quick drywall offset
- Added keyhole hanging feature on cover for ease of installation
- Common drive types on screw connections for added simplicity and convenience
- Inboard neutral to increase the gutter space for easier installation of conductors
- Backed-out neutral screws to allow for a quick connection of ground and neutral conductors
- Upgraded to embossed circuit numbers for a more clean and professional look

# 1.2

## Loadcenters and Circuit Breakers

### Type BR Loadcenters and Circuit Breakers

1

#### Catalog Number Selection

#### BR Plug-On Neutral Loadcenters

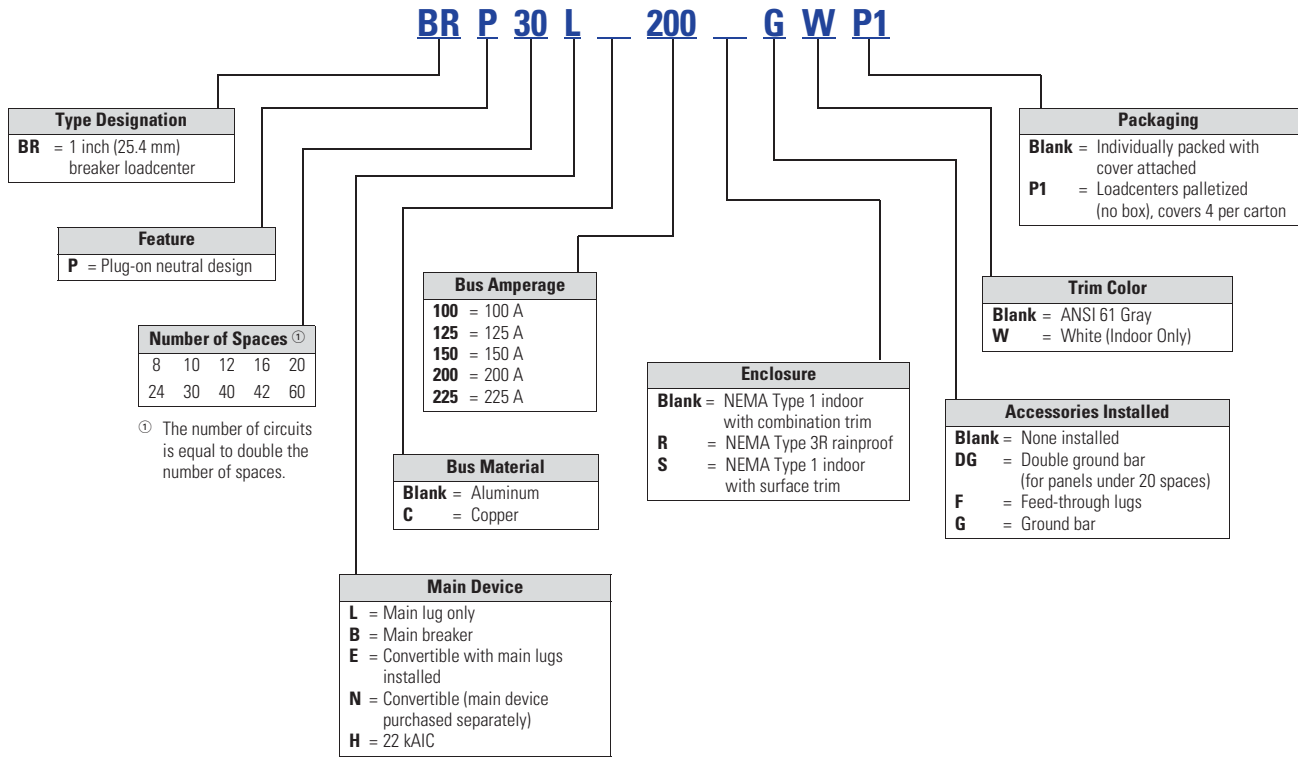

#### BR Electronic Circuit Breakers

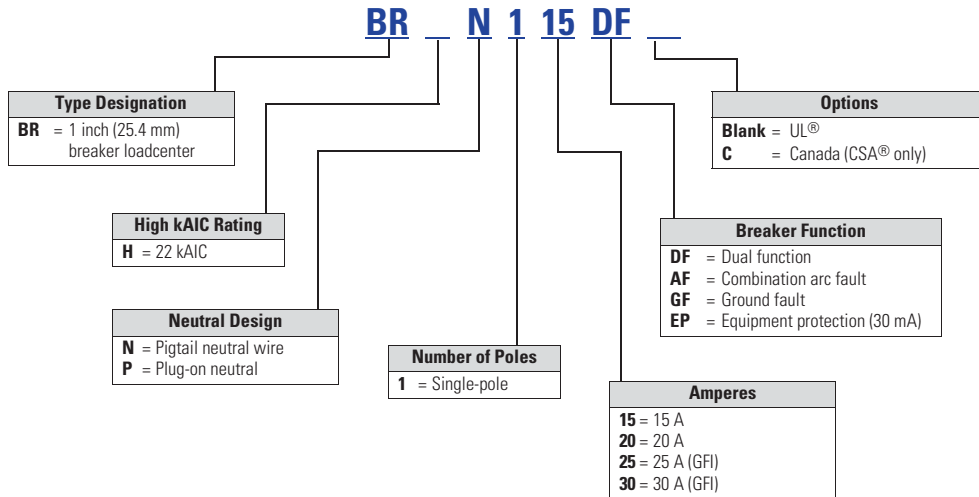

### Product Selection

BRP\_



#### BR Plug-On Neutral (PON) Loadcenters

Main Breaker Type	Main Ampere Rating	Spaces	Circuits	Enclosure Type	Box Size	Wire Size Range Cu/Al 60°C or 75°C for Main Breaker	Loadcenter Catalog Number with Combination or NEMA Type 3R Cover
CSR at 25 kAIC	200	30	60	Indoor	X6	#2–300 kcmil	<b>BRP30B200</b>
CSR at 25 kAIC	200	40	80	Indoor	X8	#2–300 kcmil	<b>BRP40B200</b>
—	200	30	60	Indoor	X5	#1–300 kcmil	<b>BRP30L200G</b>
—	200	40	80	Indoor	X8	①	<b>BRP40N200</b>

#### BR Electronic Breakers

Breaker Type	Plug-On Neutral Catalog Number	Pigtail Catalog Number	Ampere Rating	Poles	Wire Size	Breaker Type	LED Diagnostics Included
BR AFCI Breakers	<b>BRP115AF</b>	<b>BRN115AF</b>	15	Single-pole, 10 kAIC	#14–4	Combination AFCI	Yes
	<b>BRP120AF</b>	<b>BRN120AF</b>	20	Single-pole, 10 kAIC	#14–4	Combination AFCI	Yes
BR GFCI Breakers	<b>BRP115GF</b>	<b>BRN115GF</b>	15	Single-pole, 10 kAIC	#14–4	Personnel Protection GFCI	Yes
	<b>BRP120GF</b>	<b>BRN120GF</b>	20	Single-pole, 10 kAIC	#14–4	Personnel Protection GFCI	Yes
BR Dual Function Breakers	<b>BRP115DF</b>	<b>BRN115DF</b>	15	Single-pole, 10 kAIC	#14–4	Dual Function AFCI/GFCI	Yes
	<b>BRP120DF</b>	<b>BRN120DF</b>	20	Single-pole, 10 kAIC	#14–4	Dual Function AFCI/GFCI	Yes
BR 22 kAIC AFCI Breakers	—	<b>BRHN115AF</b>	15	Single-pole, 10 kAIC	#14–4	Combination AFCI	Yes
	—	<b>BRHN120AF</b>	20	Single-pole, 10 kAIC	#14–4	Combination AFCI	Yes
BR GFCI Breakers	—	<b>BRHN115GF</b>	15	Single-pole, 10 kAIC	#14–4	Personnel Protection GFCI	Yes
	—	<b>BRHN120GF</b>	20	Single-pole, 10 kAIC	#14–4	Personnel Protection GFCI	Yes
	—	<b>BRHN125GF</b>	25	Single-pole, 10 kAIC	#14–4	Personnel Protection GFCI	Yes
	—	<b>BRHN130GF</b>	30	Single-pole, 10 kAIC	#14–4	Personnel Protection GFCI	Yes
BR 30 mA GFCI Breakers	—	<b>BRN115EP</b>	15	Single-pole, 10 kAIC	#14–4	Equipment Protection	Yes
	—	<b>BRN120EP</b>	20	Single-pole, 10 kAIC	#14–4	Equipment Protection	Yes
	—	<b>BRN125EP</b>	25	Single-pole, 10 kAIC	#14–4	Equipment Protection	Yes
	—	<b>BRN130EP</b>	30	Single-pole, 10 kAIC	#14–4	Equipment Protection	Yes
BR 22 kAIC Dual Function Breakers	—	<b>BRHAFGF115</b>	15	Single-pole, 10 kAIC	#14–4	Dual Function AFCI/GFCI	Yes
	—	<b>BRHAFGF120</b>	20	Single-pole, 10 kAIC	#14–4	Dual Function AFCI/GFCI	Yes

**Note**

① See Main Breaker and Main Lug Kit tables, **Page V1-T1-52**.

#### BR Quick Connect Neutral Loadcenters



### BR Quick Connect Neutral Loadcenters

#### Product Description

The Type BR Quick Connect Neutral loadcenters coupled with Type BR Quick Connect Neutral electronic breakers provide a clean, quick connection for an installer looking to save time while providing a professional look.

#### Features and Benefits

- Full-length neutral bars provide over 300% neutral capacity while enhancing installation flexibility for the installer
- Backed-out neutral screws allow an installer to make a quick connection when terminating neutral and ground wires
- Extended circuits (30/60, 40/80) provide maximum flexibility to a contractor on every space possible
- Standard LED diagnostics on AFCI and AF/GF breakers provides installers best-in-class troubleshooting technology
- Cut-to-length neutral wires provides a clean, professional look versus traditional pigtail circuit breakers
- Solid-tip, stranded neutral wires provide a quick connection to the full length neutral bar

### Contents

<i>Description</i>	<i>Page</i>
Overview . . . . .	V1-T1-42
BR Specialty Products	
BR Plug-On Neutral Loadcenters . . . . .	V1-T1-57
BR Quick Connect Neutral Loadcenters	
Spa Panels . . . . .	V1-T1-61
Riser Panel . . . . .	V1-T1-62
Type BR Renovation Loadcenter . . . . .	V1-T1-63
BR Loadcenter Options and Accessories . . . . .	V1-T1-66
BR Circuit Breakers . . . . .	V1-T1-80

### Product Selection

#### BR Quick Connect Neutral Loadcenters ①

Main Device	Ampere Rating	Spaces	Circuits ②	Incoming Lug Size	Enclosure Type ③	Box Size	Ground Bar	Number of Neutral Terminations	Catalog Number
BR 10 kAIC	100	30	60	#4-1/0	Indoor	D1	④	96	BR3060BQN100
CSR 25 kAIC	150	30	60	#2-300 kcmil	Indoor	G1	④	102	BR3060BQN150
CSR 25 kAIC	200	30	60	#2-300 kcmil	Outdoor	L1R	④	94	BR3060BQN200R
CSR 25 kAIC	200	40	80	#2-300 kcmil	Outdoor	G1R	④	128	BR4080BQN200R
Main lug only	125	24	48	#6-2/0	Indoor	C2	GBK14	80	BR2448LQN125G
Main lug only	125	30	60	#6-2/0	Indoor	D1	GBK10	96	BR3060LQN125G
Main lug only	200	30	60	#1-300 kcmil	Indoor	D1	GBK1020 + GBK10	96	BR3060LQN200G
Main lug only	200	40	80	#1-300 kcmil	Indoor	G1	GBK1020 + GBK10	122	BR4080LQN200G
Main lug only	125	20	40	#6-2/0	Outdoor	C1R	GBK14	68	BR2040LQN125RG
Main lug only	200	30	60	#1-300 kcmil	Outdoor	D1R	GBK1420	94	BR3060LQN200RG
Convertible	200	30	60	—	Indoor	G1	④	102	BR3060NQN200
Convertible	200	40	80	—	Indoor	L1	④	128	BR4080NQN200
Convertible	200	30	60	—	Outdoor	G1R	④	94	BR3060NQN200R
Convertible	200	40	80	—	Outdoor	L1R	④	128	BR4080NQN200R

#### BR Quick Connect Neutral Electronic Breakers

Ampere Rating	Poles	Wire Size	Breaker Type	LED Diagnostics Included	Catalog Number
15	Single-pole 10 kAIC	#14-4	Combination AFCI	Yes	BRCAF115QN
20	Single-pole 10 kAIC	#14-4	Combination AFCI	Yes	BRCAF120QN
15	Single-pole 10 kAIC	#14-4	Arc fault/ground fault	Yes	BRLAFGF115QN
20	Single-pole 10 kAIC	#14-4	Arc fault/ground fault	Yes	BRLAFGF120QN

#### Notes

- ① BR Quick Connect Neutral loadcenters accept both standard and Quick Connect Neutral breakers.
- ② Loadcenters accept Type BR twin breakers.
- ③ Combination cover included with every indoor loadcenter.
- ④ Ground bar kit not included. Purchase separately.

### Spa Panels



### Spa Panels

#### Product Description

Eaton's BR Spa Panels distribute power to outdoor loads and provide protection for people from electric shock. Save time and money with streamlined installation procedures and easy-access features. Spa panels meet NEC requirements by providing a ground fault circuit interruption device and a disconnect switch in a single simple device. Ships assembled prewired, factory tested and ready to install.

#### Features

- 10-year warranty
- UL Listed
- Factory-installed two-pole ground fault circuit interrupter (GFCI)

#### Product Selection

##### BR Spa Panel



#### Spa Panel—Meets NEC Article 680.40 Through 680.43—Requirements for GFCI Protection

Main Ampere Rating	Maximum Number 1-Inch (25.4 mm)		Enclosure Type	Box Size	Wire Size Range Cu/Al 60 °C or 75 °C for Main Lugs	Catalog Number
	Space	Poles				
40	—	—	Outdoor	5R	#8-#2	BR40SPAST <sup>①</sup>
50	—	—	Outdoor	5R	#8-#2	BR50SPAST <sup>②</sup>

#### Notes

- ① Includes a GFTCB240 breaker, factory installed.
- ② Includes a GFTCB250 breaker, factory installed.

### Contents

#### Description

	<i>Page</i>
Overview .....	V1-T1-42
BR Specialty Products	
BR Plug-On Neutral Loadcenters .....	V1-T1-57
BR Quick Connect Neutral Loadcenters .....	V1-T1-60
Spa Panels	
Riser Panel .....	V1-T1-62
Type BR Renovation Loadcenter .....	V1-T1-63
BR Loadcenter Options and Accessories .....	V1-T1-66
BR Circuit Breakers .....	V1-T1-80

#### Riser Panel



#### Contents

<i>Description</i>	<i>Page</i>
Overview . . . . .	<b>V1-T1-42</b>
BR Specialty Products	
BR Plug-On Neutral Loadcenters . . . . .	<b>V1-T1-57</b>
BR Quick Connect Neutral Loadcenters . . . . .	<b>V1-T1-60</b>
Spa Panels . . . . .	<b>V1-T1-61</b>
Riser Panel	
Type BR Renovation Loadcenter . . . . .	<b>V1-T1-63</b>
BR Loadcenter Options and Accessories . . . . .	<b>V1-T1-66</b>
BR Circuit Breakers . . . . .	<b>V1-T1-80</b>

### Riser Panel

#### Product Description

Eaton's Riser Panel is a loadcenter with an offset interior to allow riser cables to pass through the enlarged gutter. By using lay-in tap lugs, the contractor is able to simply strip off a length of the riser cable's insulation, and tap off to the riser panel's main lugs. These panels are used in the construction of assisted living homes, dormitories, public housing complexes and apartments.

#### Product Selection

##### BR1224L125RIS



#### Riser Panel

Main Ampere Rating	Maximum Number 1-Inch (25.4 mm)		Enclosure Type	Box Size	Wire Size Range Cu/Al 60 °C or 75 °C for Main Lugs	Catalog Number
	Space	Circuits				
125	12	24	Indoor	C4	#6-2/0	<b>BR1224L125RIS</b>
125	12	24	Indoor	C4	#6-2/0	<b>BR1224L125RISBP</b> ①
125	20	24	Indoor	C4	#6-2/0	<b>BR2024L125RIS</b>
125	20	24	Indoor	C4	#6-2/0	<b>BR2024L125RISBP</b> ①
125	20	30	Indoor	C2	#6-2/0	<b>BR2030L125RIS</b>
200	30	40	Indoor	D1	#1-300	<b>BR3040L200RIS</b>

##### BRGUTTER (Shown with Loadcenter)



#### Riser Panel Accessories

##### Catalog Number

**BRGUTTER** ②

**GTAP250**

#### Notes

- ① Bulk-packaged loadcenter without carton. Must be ordered in multiples of 16.
- ② Refer to **Page V1-T1-77** for dimensions. BRGUTTER is box size C2.

#### Accessories

For riser panels not shown, contact the Flex Center at 1-800-330-6479 for both CH and BR riser panels.

### BR Renovation Loadcenters

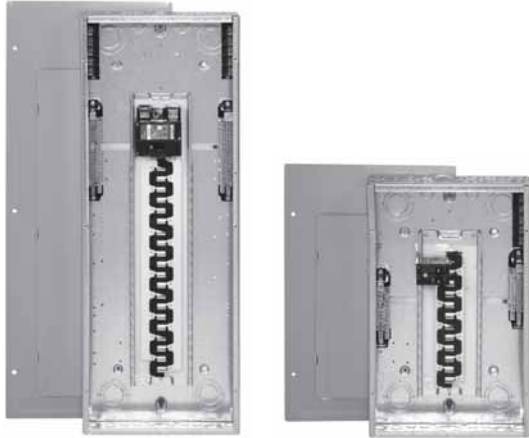

### Contents

<b>Description</b>	<b>Page</b>
Overview .....	<b>V1-T1-42</b>
BR Specialty Products	
BR Plug-On Neutral Loadcenters .....	<b>V1-T1-57</b>
BR Quick Connect Neutral Loadcenters .....	<b>V1-T1-60</b>
Spa Panels .....	<b>V1-T1-61</b>
Riser Panel .....	<b>V1-T1-62</b>
Type BR Renovation Loadcenter	
BR Loadcenter Options and Accessories .....	<b>V1-T1-66</b>
BR Circuit Breakers .....	<b>V1-T1-80</b>

## Type BR Renovation Loadcenter

### Product Description

- Available in 10, 20, 30 and 40 circuit main breaker styles
- Designed to replace existing loadcenters and fuse boxes
- Type BR loadcenter packaged with circuit breakers
- Factory-installed 5-circuit terminal block(s)
- Twin-stacked neutral design

### Features, Benefits and Functions

- Factory-installed terminal block(s) allows installer to terminate existing short wires without using wire nuts or junction boxes
- Twin-stacked neutrals are mounted up high in the loadcenter, which allows for all neutral and ground wires to be terminated in the top half of the loadcenter
- Specifically designed for the service contractor—this is the ONLY renovation line in the industry
- Single-pole and two-pole breakers included
- 10-year warranty on loadcenter and breakers

## Product Selection

### BR2020B100RN



### BR Value Packs ①

Main Breaker Type	Description	Wire Size Range	Number of 5-Circuit Terminal Blocks	Single-Pole Breakers	Two-Pole Breakers	Catalog Number
BR 10 kAIC	Single-phase 100 A 10k main breaker 10/20 circuit surface-mount box is 11.75" wide x 13" tall	#6-1/0	0	(2) BR115	(1) BR230	<b>BR1020B100SRNV</b>
	Single-phase 100 A 10k main breaker 10/20 circuit flush-mount box is 11.75" wide x 13" tall		0	(2) BR115	(1) BR230	<b>BR1020B100FRNV</b>

### Note

① Indoor enclosure type.



#### Type BR Retrofit Interior



**Type BR Retrofit Adjustable Interior**



**Type BR Retrofit Interior Collar and Assembly with Trim**

### Contents

<b>Description</b>	<b>Page</b>
Overview .....	<b>V1-T1-42</b>
BR Specialty Products	
BR Plug-On Neutral Loadcenters .....	<b>V1-T1-57</b>
BR Quick Connect Neutral Loadcenters .....	<b>V1-T1-60</b>
Spa Panels .....	<b>V1-T1-61</b>
Riser Panel .....	<b>V1-T1-62</b>
Type BR Renovation Loadcenter .....	<b>V1-T1-63</b>
BR Loadcenter Options and Accessories	
Type BR Retrofit Interior Kits	
BR Specialty Product Selection .....	<b>V1-T1-65</b>
Type BR Mechanical Interlock Kits .....	<b>V1-T1-68</b>
Technical Data and Specifications .....	<b>V1-T1-73</b>
Dimensions .....	<b>V1-T1-76</b>
BR Circuit Breakers .....	<b>V1-T1-80</b>

### Type BR Retrofit Interior Kits

#### Product Description

Eaton's unique Retrofit Interior allows the customer to cost-effectively and safely upgrade an electrical service without removing the existing enclosure from the wall.

#### Application Description

The Retrofit Interior is designed and tested specifically for renovating an outdated electrical panel in an apartment, a condominium or a single family home. These outdated panels are being recognized by local inspectors and other authorities as a possible hazard.

#### Opportunities to Retrofit

- Single- or three-phase
- Main lug only or main breaker
- Up to 42 circuits
- Up to 225 A interiors, 400 A available upon request
- Available with CH breakers (3/4-inch) with copper bus or BR breakers (1-inch) with aluminum bus
- The minimum lifetime warranty for residential breakers shall be as follows:
  - 10-year warranty on all BR branch breakers and loadcenters
  - Refer to Eaton for complete warranty details

#### Features and Benefits

##### **Upgrading Existing Electrical Infrastructure Is Simple**

- Replaces vintage brands that have hard to find, expensive replacement breakers
- Safety upgrade to arc fault and ground fault breakers to meet current electrical codes
- Maximizes number of circuits available with compact design
- Eco-friendly in asbestos-filled environments
- Exclusive design

##### **Save Time and Money Throughout the Installation**

- Uses existing panel box and wires
- Eliminates expensive and time-consuming drywall/paint repair
- Saves 2–3 hours of installation time compared to a complete panel changeout
- Eliminates precise measurements with field-adjustable kit

#### Standards and Certifications

- Meets 2017 NEC wire bending requirements
- UL 67 Listed (for UL listings for specific part numbers, see the table on the following page.)



### BR Specialty Product Selection

To select the retrofit kit:

1. From the existing box size determine which retrofit groups are suitable (may be more than one).
2. Use type of interior, number of phases, and type of main to find the selection chart.
3. Select part number from chart (if main breaker, replace XXX with specific amp rating).

#### How to Order:

1. Measure the existing panel enclosure to determine appropriate kits for your project.
2. Match the existing dimensions with the table below to obtain the correct catalog number.
3. Order your retrofit kit from a local Eaton authorized distributor.

Need assistance or can't find retrofit to fit existing enclosure?

Call Eaton's Residential Flex Center at 1-800-330-6479 or email for all your retrofit needs. Go to [www.eaton.com/eccn](http://www.eaton.com/eccn) to locate an Eaton Certified Contractor.

### Retrofit Interior Kit Specifications

Five recommended groups: existing box height determines retro group size. Approximate Dimensions in Inches (mm).

Catalog Number ①	Cover ②	Existing Enclosure Parameters—Inches (mm)				Phase	Main	Bus	Amperes ③	Spaces / Circuits	UL 67 Listed
		Minimum Depth	Maximum Depth	Minimum Width	Minimum Height						
<b>BR Retrofit Interiors and Covers</b>											
RTBR8L100P	CRTBR8ML****	3.13 (79.5)	3.63 (92.2)	10.50 (266.7)	13.00 (330.2)	Single	MLO	BR	100	8/16	Yes
RUBR8L100_	CRUBR8ML****	3.75 (95.3)	6.00 (152.4)	10.50 (266.7)	13.00 (330.2)	Single	MLO	BR	100	8/16	Yes
RTBR12L100P	CRTBR12ML****	3.13 (79.5)	3.63 (92.2)	10.50 (266.7)	14.50 (368.3)	Single	MLO	BR	100	12/24	Yes
RTBR10B100P	CRTBR12ML****	3.13 (79.5)	3.63 (92.2)	10.50 (266.7)	14.50 (368.3)	Single	MLO	BR	100	10/20	Yes
RUBR12L100_	CRUBR12ML****	3.75 (95.3)	6.00 (152.4)	10.50 (266.7)	14.50 (368.3)	Single	MLO	BR	100	12/24	Yes
RUBR10B100_	CRUBR12ML****	3.75 (95.3)	6.00 (152.4)	10.50 (266.7)	14.50 (368.3)	Single	MB	BR	100	10/20	Yes
RTBR12L125P	CRTBR12ML****	3.13 (79.5)	3.63 (92.2)	11.00 (279.4)	17.00 (431.8)	Single	MLO	BR	125	12/24	Yes
RTBR10B125P	CRTBR12ML****	3.13 (79.5)	3.63 (92.2)	11.00 (279.4)	17.00 (431.8)	Single	MB	BR	125	10/20	Yes
RUBR12L125_	CRUBR12ML****	3.75 (95.3)	6.00 (152.4)	11.00 (279.4)	17.00 (431.8)	Single	MLO	BR	125	12/24	Yes
RUBR10B125_	CRUBR12ML****	3.75 (95.3)	6.00 (152.4)	11.00 (279.4)	17.00 (431.8)	Single	MB	BR	125	10/20	Yes
RABR20B125_	CRABR20ML****	3.75 (95.3)	6.00 (152.4)	13.00 (330.2)	21.00 (533.4)	Single	MCB	BR	125	20/24	No
RABR20L125_	CRABR20ML****	3.75 (95.3)	6.00 (152.4)	13.00 (330.2)	21.00 (533.4)	Single	MLO	BR	125	20/24	No
RBBR20B200_	CRBBR20BW****	3.75 (95.3)	6.00 (152.4)	13.00 (330.2)	29.00 (736.6)	Single	MLO	BR	200	20/40	No
RBBR20L200_	CRBBR20BW****	3.75 (95.3)	6.00 (152.4)	13.00 (330.2)	29.00 (736.6)	Single	MLO	BR	200	20/40	No
RBBR40L200_	CRBBR40ML****	3.75 (95.3)	6.00 (152.4)	13.00 (330.2)	34.00 (863.6)	Single	MLO	BR	200	30/40	No
RDBR40B200_	CRDBR40BW****	3.75 (95.3)	6.00 (152.4)	13.00 (330.2)	37.00 (939.8)	Single	MLO	BR	200	40/40	No

#### Complete Assembly

**Note:** For complete assembly, interior and cover need to be ordered separately.

#### Adjustable Interior

- Factory installed ground and neutral bars positioned to accept existing wires
- Field adjustable depth matches existing panel box
- Adjustable height enables optional placement of the interior
- Field bondable for service entrance options



Adjustable Interior

#### Standard Trim and Collar

- Standard trim matches new interior
- New circuit directory for updated labeling
- Oversized collar eliminates expensive wall/paint repair



Collar and Assembly with Trim

#### Notes

- ① Catalog numbers shown with "\_" at the end need one of the following suffixes to denote depth:  
J = 3.75–4.25  
K = 4.25–5.00  
L = 5.00–6.00  
Example: RUBR12L125J would signify an interior set with a depth range of 3.75 to 4.25 inches.
- ② \*\*\*\* Denotes characters in the catalog number that relate to overall cover size. Example: CRTBR12ML2620 would signify a cover 26.00 inches H x 20.00 inches W.
- ③ Amperes for MB panels is maximum; catalog number will reflect actual amperage of breaker included.

For UL applications, maximum cover sizes may apply.

Options and Accessories—Mechanical Interlocks



### Contents

<i>Description</i>	<i>Page</i>
Overview . . . . .	V1-T1-42
BR Specialty Products	
BR Plug-On Neutral Loadcenters . . . . .	V1-T1-57
BR Quick Connect Neutral Loadcenters . . . . .	V1-T1-60
Spa Panels . . . . .	V1-T1-61
Riser Panel . . . . .	V1-T1-62
Type BR Renovation Loadcenter . . . . .	V1-T1-63
BR Loadcenter Options and Accessories	
Type BR Retrofit Interior Kits . . . . .	V1-T1-64
Type BR Mechanical Interlock Kits . . . . .	V1-T1-68
Technical Data and Specifications . . . . .	V1-T1-73
Dimensions . . . . .	V1-T1-76
BR Circuit Breakers . . . . .	V1-T1-80

## BR Loadcenter Options and Accessories

### Product Selection

**BRSF125**



**3BRS225**



**BRL200**



**TDL**



### Field Installation Kits and Parts

Number of Poles	Ampere Rating	Number of 1-Inch (25.4 mm) Spaces Needed	Wire Size Range Cu/Al 60 °C or 75 °C	Ordering Quantity ①	Catalog Number
<b>Main and Sub-Feed Lug Blocks</b>					
2	125	2	#8–2/0	1	<b>BRSF125</b>
	150	2	#8–2/0	1	<b>BRSF150</b> ②
	225	4	#2–300 kcmil	1	<b>BRS225</b>
3	150	3	#8–2/0	1	<b>3BRSF150</b> ②
	225	6	#2–300 kcmil	1	<b>3BRS225</b>
<b>Main Lugs</b>					
Two-pole, 200 A stud mounted (includes deadfront filler plate)			#1–300 kcmil	1	<b>BRL200</b>
Neutral/ground lug			#2/0 maximum	1	<b>NL20</b>
Add-on neutral or ground lug			#3/0 maximum	1	<b>NL30</b>
			300 kcmil maximum	1	<b>NL300</b>
<b>Filler Plates</b>					
1-inch (25.4 mm) circuit breaker space				25	<b>BRFP</b>
BW main circuit breaker space (with hardware)				1	<b>BWFP</b>
Door lock—12–42 circuits, and 100–225 A				1	<b>TDL</b>
Door lock—4–8 circuits, 125 A				1	<b>CH9FL</b>
ANSI-61 light gray touchup paint for current loadcenters				1	<b>SPC61</b>
Isolated neutral assembly (computer circuits)				1	<b>BINA</b>
Circuit directory—adhesive backed				10	<b>TCD</b>
Cover screws				25	<b>LCCS</b>
Cover replacement latch (gray) 14-5/16 (363.5 mm) wide loadcenters only				1	<b>BRRL</b>
Circuit marking strip (next to breaker)				10	<b>BRMS</b>
Circuit identification label (preprinted breaker labels)				25	<b>CHBL</b>
Series rated caution label				25	<b>SRL</b>
Bonding strip with screw				1	<b>BSSUSE</b>

**Notes**

- ① Must be purchased in multiples of ordering quantities indicated.
- ② #8–2/0 wire size range is 75 °C rated only.

**Three-Phase Accessories****Three-Phase Main Breaker Kits— 10 kAIC**

<b>Ampere Rating</b>	<b>Wire Size Range Cu/Al 60 °C or 75 °C</b>	<b>Catalog Number</b>
100	#6–4/0	<b>CC3100N</b>
125	#6–4/0	<b>CC3125N</b>
150	#6–4/0	<b>CC3150N</b>
175	#2/0–300 kcmil	<b>CC3175N</b>
200	#2/0–300 kcmil	<b>CC3200N</b>
225	#2/0–300 kcmil	<b>CC3225N</b>

**Three-Phase Main Lugs Kit for Convertible Loadcenters**

<b>Ampere Rating</b>	<b>Wire Size Range Cu/Al 60 °C or 75 °C</b>	<b>Catalog Number</b>
225	#1–300 kcmil	<b>3BRL225</b>
225	#1–300 kcmil	<b>3BRS225</b> ①

**Note**

① For subfeed.

Box sizes **Pages V1-T1-76** through **V1-T1-79**.

#### Type BR Mechanical Interlock Kits



**Type BR Loadcenter with Mechanical Interlock Kit**

### Type BR Mechanical Interlock Kits

#### Product Description

With the aging electrical infrastructure and frequent severe storms, power outages are becoming more and more frequent, affecting thousands of people nationwide. Eaton mechanical interlock kit provides an easy and cost-effective solution when using backup emergency power.

This solution expands the robust line of emergency power products and accessories.

#### Features and Benefits

- Prevents utility and generator supplies from being on at the same time
- Protects utility linemen from dangerous generator backfeed
- Robust interlock design
- Offered in two unique styles for almost any BR loadcenter, which can reduce inventory levels
- Quick and easy installation—drill points or fixtures for pilot holes are provided on all applicable BR loadcenters; no additional assembly is required

### Contents

#### Description

	<i>Page</i>
Overview	V1-T1-42
BR Specialty Products	
BR Plug-On Neutral Loadcenters	V1-T1-57
BR Quick Connect Neutral Loadcenters	V1-T1-60
Spa Panels	V1-T1-61
Riser Panel	V1-T1-62
Type BR Renovation Loadcenter	V1-T1-63
BR Loadcenter Options and Accessories	
Type BR Retrofit Interior Kits	V1-T1-64
Type BR Mechanical Interlock Kits	V1-T1-68
Technical Data and Specifications	V1-T1-73
Dimensions	V1-T1-76
BR Circuit Breakers	V1-T1-80

#### Standards and Certifications

- UL 67 Listed—For use with BR loadcenters
- Meets NEC® Article 702



#### Product Selection



Each mechanical interlock kit includes:

- Interlock assembly
- Hold down kit ①
- New labels
- Necessary screws

Warranty information:

- 10-year warranty on all Type BR circuit breakers and loadcenters
- Refer to Eaton for complete warranty details

#### Mechanical Interlock Kits ②

	Description	Catalog Number
	Single	<b>BRMIKBR</b>
	Bulk pack ③	<b>BRMIKBRBP</b>
	Single	<b>BRMIKCSR</b>
	Bulk pack ③	<b>BRMIKCSRBP</b>

#### Notes

- ① For breakers under 70 A used in backfed applications, add “B” to the end of the catalog string to get the appropriate “hold-down” version.
- ② Clamshell packaged.
- ③ Bulk pack contains 10 units, individually packaged.

### Mechanical Interlock Cover

Covers mechanically interlock two breakers—Type BW or CSR main breaker with a Type BR branch breaker.

BR816B100



### Mechanical Interlock Cover

Fits Loadcenter Catalog Numbers	Mechanical Interlock Trim/Deadfront Catalog Numbers	Mechanical Interlock Kit Catalog Numbers
<b>Indoor</b>		
BR816B100	BRCOVC10M	BRMIKBR
BR816N100		
BR1212B100	BRCOVC12M	
BR1220B100		
BR1220H100		
BR1224N125	BRCOVC13M	
BR1616B100	BRCOVC16M	
BR1620B100		
BR1624B100		
BR1624B125	BRCOVC17M	
BR1624N125		
BR2020B100, BR2020BC100 BR2020H100, BR2020HC100	BRCOVC22M	
BR2024H100		
BR2020HC100		
BR2030B100		
BR2040B100		
BR2024B125	BRCOVC23M	
BR2024N125, BR2024NC125		
BR3030B100, BR3030BC100	BRCOVC59M	
BR3030H100, BR3030HC100		
<b>Raintight</b>		
BR1020B100R	BR3RDF1M	Field-installed interlock kits not available for these catalog numbers.
BR1224B100R		
BR1224N125R, BR1224NC125R		
BR1624B100R	BR3RDF2M	
BR1624N125R		
BR2024B100R, BR2024B125R	BR3RDF4M	
BR2024N125R, BR2024NC125R		

BR4040B200



## Mechanical Interlock Cover, continued

Fits Loadcenter Catalog Numbers	Mechanical Interlock Trim/Deadfront Catalog Numbers	Mechanical Interlock Kit Catalog Numbers
<b>Indoor</b>		
BR1630B150	BRCOV16C4FM	BRMIKCSR
BR1224N200		
BR1632B200		
BR1632N200		
BR2030B150	BRCOV20C4FM	
BR2030H150		
BR2040B150		
BR2040B200, BR2040BC200	BRCOV20D1FM	
BR2040H200		
BR2040N200, BR2040NC200		
BR2430B150, BR2430BC150	BRCOV30G1FM	
BR3030B150		
BR3030H150		
BR3040B150		
BR2440B200		
BR2440N200		
BR3040BC200		
BR3040N200, BR3040NC200		
BR4040BC200	BRCOV40L1FM	
BR4040N200, BR4040NC200		
BR4242B225	BRCOV42L2FM	
<b>Raintight</b>		
BR816B150RF	BR3RDF5M ①	
BR816B200RF		
BR816N200RF		
BR1224N200R		
BR2030B150R	BR3RDF11M ①	
BR2040B150R		
BR2040B200R		
BR2040B225R		
BR2040N200R		
BR3030B150R	BR3RDF12M ①	
BR3040B200R		
BR3040N200R		
BR4040B200R	BR3RDF13M ①	
BR4040N200R		
BR48B200RF	BR3RDF14M	
BR4242B225R	BR3RDF15M ①	
<b>Mechanical Interlock Loadcenter Replacement Covers ②</b>		
BR2020B100M, BR2020BC100M	BRCOV20C2FM	Field-installed interlock kits not available for these catalog numbers.
BR2024H100M		
BR3030BC100M	BRCOV30D1FM	

**Notes**

① Deadfront only.

② Can only be provided as replacement covers for factory-installed mechanically interlock loadcenters.

### DS300H2



### Field Installation Rainproof Conduit Hubs

#### Description

Group 1—for use with 70, 100 and 125 A MLO and MCB loadcenters and circuit breaker enclosures and the following 150 and 200 A panels: BR48B200RF

Group 2—for use with 150, 200 and 225 A MLO and MCB loadcenters and circuit breaker enclosures except for the following 200 A loadcenters: BR48B200RF. Also for use with 400 and 600 A loadcenters and New York City loadcenters manufactured after November 1, 2005

Type H conduit hubs for loadcenters PL0724R and S3100RN

Adapter kit—Allows installing a Group 1 hub on devices arranged for Group 2 hubs

Group 1 small blank hub plate with bump

Group 2 Large blank hub plate with bump

Conduit Size Inches (mm)	Ordering Quantity <sup>①</sup>	Catalog Number
0.75 (19.1)	1	DS075H1
1.00 (25.4)	1	DS100H1
1.25 (31.8)	1	DS125H1
1.50 (38.1)	1	DS150H1
2.00 (50.8)	1	DS200H1
2.00 (50.8)	1	DS200H2
2.50 (63.5)	1	DS250H2
3.00 (76.2)	1	DS300H2
0.75 (19.1)	1	RH75P
1.00 (25.4)	1	RH100P
1.25 (31.8)	1	RH125P
1.50 (38.1)	1	RH150P
—	1	DS900AP
—	1	DS900CP1
—	1	DS900CP2

### GBK14



### BRGBK39512



### Ground Bar Kits

Description (See Legend)	Length Inches (mm)	Ordering Quantity <sup>①</sup>	Catalog Number
●○○○○●○	2.54 (64.5)	1	GBK5 <sup>②</sup>
●○○○○●■	3.59 (91.2)	1	GBK520 <sup>②</sup>
●○○○○●○○○○○	4.29 (109.0)	1	GBK10 <sup>②</sup>
●○○○○●○○○○○■	5.34 (135.6)	1	GBK1020 <sup>②</sup>
— — — — —	4.61 (117.1)	1	GBK13 <sup>②</sup>
●○○○○●○○○○○○○○○○	5.69 (144.5)	1	GBK14 <sup>②</sup>
●○○○○●○○○○○○○○○○■	6.74 (171.2)	1	GBK1420 <sup>②</sup>
●○○○○●○○○○○○○○○○○○○○○○	8.14 (206.8)	1	GBK21 <sup>②</sup>
●○○○○●○○○○○○○○○○○○○○○○■	9.19 (233.4)	1	GBK2120 <sup>②</sup>
⌞ — ⌞ — ⌞ — ⌞ — ⌞	5.78 (146.8)	1	BRGBK39512 <sup>③④</sup>
○○○○○	1.84 (46.7)	1	GB4NM <sup>⑤</sup>

#### Ground Bar Legend

- (3) #14–10 Cu/Al or (1) #14–4 Cu/Al
- (1) #6–2/0 Cu/Al
- ⌞ (1) #14–1/0 Cu/Al or (3) #14–10 Cu/Al
- ⌠ (1) #14–6 Cu/Al or (2) #14–12 Cu/Al
- Mounting Hole

#### Notes

- ① Must be purchased in multiples of ordering quantities indicated.
- ② Distance between mounting holes is 1.75 inches (44.5 mm).
- ③ For single- and three-phase 400 and 600 A applications.
- ④ Distance between mounting holes is 2.34 inches (59.5 mm).
- ⑤ For non-metallic enclosures. Snaps into molded base.



# 1.2

## Loadcenters and Circuit Breakers

### Type BR Loadcenters and Circuit Breakers

1

#### Loadcenter Goof Collars

Don't let an ugly drywall problem ruin a beautiful electrical installation.

Eaton's Goof Collar is designed to cover gaps between the finished drywall and loadcenter enclosure.

This is often necessary when upgrading the electrical service and the drywall surrounding the panel is damaged. The collar allows 2 inches of overhang beyond the standard flush trim.



Before



After

#### BR Goof Collars

Inches (mm)		Catalog Number	
Height	Width	BR Box Size	Goof Collar
21.00 (533.4)	19.00 (482.6)	<b>B1</b>	<b>BRB1GC2119</b>
23.00 (584.2)	19.00 (482.6)	<b>B2</b>	<b>BRB2GC2319</b>
25.00 (635.0)	19.00 (482.6)	<b>C1</b>	<b>BRC1GC2519</b>
27.00 (685.8)	19.00 (482.6)	<b>C2</b>	<b>BRC2GC2719</b>
31.00 (787.4)	19.00 (482.6)	<b>C4</b>	<b>BRC4GC3119</b>
34.00 (863.6)	19.00 (482.6)	<b>D1</b>	<b>BRD1GC3419</b>
38.00 (965.2)	19.00 (482.6)	<b>G1</b>	<b>BRG1GC3819</b>
43.00 (1092.2)	19.00 (482.6)	<b>L1</b>	<b>BRL1G4319</b>
48.00 (1219.2)	19.00 (482.6)	<b>L2</b>	<b>BRL2GC4819</b>

#### Note

Type BD Duplex, BQ and BQC Quadplex circuit breakers can be installed in Circuit Limiting (CTL) listed BR loadcenters. Type BR twin breakers can be installed in Non-CTL BR loadcenters.

**Technical Data and Specifications****General**

- A. The Contractor shall furnish and install deadfront loadcenters incorporating circuit breakers of the number, rating and type as specified herein and as shown on the contract drawings.
- B. The loadcenter and all components shall be designed, manufactured and tested in accordance with the latest applicable standards of UL, NEMA and NEC including:
  - 1. UL 67—Standards for Panelboards.
  - C. UL 50—Standards for Cabinets and Boxes.
  - D. UL 489—Standards for Molded Case Circuit Breakers.
  - E. UL 869—Standards for Service Equipment.
  - F. Federal Specification W-C 375B—Circuit Breakers.
  - G. Federal Specification W-C P115b—Panel Power Distribution Type 1, Class 2.

**Qualifications**

- A. The manufacturer of the loadcenter shall be the manufacturer of the circuit breaker within the loadcenter.
- B. For the equipment specified herein, the manufacturer shall be ISO 9000 certified.
- C. The manufacturer of this equipment shall have produced similar electrical equipment for a minimum period of seven (7) years.

**Manufacturers**

- A. Eaton.

**Ratings**

- A. Loadcenters shall be rated for 120/240 Vac and shall have short-circuit ratings as shown on the drawings or as herein scheduled, but not less than 10,000 amperes rms symmetrical.
- B. Circuit breakers shall be a minimum of 125 A frame. Circuit breakers 15 through 125 A trip size shall take up the same pole spacing.
- C. Loadcenters shall be labeled with a UL short-circuit rating. When series combination ratings are applied with integral or remote upstream devices, a label shall be provided. Series combination ratings shall cover all trip ratings of installed frames. It shall state the conditions of the UL series ratings including:
  - 1. Size and type of upstream device.
  - 2. Branch devices that can be used.
  - 3. UL series short circuit rating.

**Construction**

- A. All interiors, with the exception of the branch circuit breakers, shall be completely factory assembled with main breakers, main lugs, or no main device.
- B. Interiors shall be designed so that circuit breakers can be replaced without disturbing adjacent units and without removing the main bus connectors and shall be designed so that circuits may be changed without machining, drilling, or tapping.
- C. Physical means shall be provided to prevent the installation of more overcurrent devices than that number for which the enclosure was designed, rated and approved. Half-size breakers shall have a UL listed rejection tab over the line terminals. Loadcenter interiors must have notched stabs to accept these rejection tab class CTL breakers, if required and approved.

**Bus**

- A. Busbars for the main and cross connectors shall be [tin-plated aluminum] [copper] in accordance with Underwriters Laboratories standards. Busing shall be braced throughout to conform to industry standard practice governing short-circuit stresses in loadcenters.

**Note:** Note to spec writer—select one (copper available in limited ratings).

- B. Neutral busing shall have a suitable lug for each outgoing feeder requiring a neutral connection of same ampacity as branch.

**Wiring/Termination**

- A. All wire connectors and terminals shall be of the anti-turn solderless type and shall be suitable for copper or aluminum wire of the sizes indicated. All connectors must meet the "Requirements for Wire Connectors and Soldering Lugs" as stated in UL 486B.
- B. All loadcenters where marked shall be suitable for use with 60 °C or 75 °C rated wire.

**Circuit Breakers**

- A. Circuit breakers shall be molded case type. Circuit breakers shall have four-rivet construction (GFI Type—5 rivets). Multipole circuit breakers shall be of a stack pole design to provide electrical phase isolation.
- B. Each pole of the circuit breaker will provide inverse time delay overload and instantaneous short-circuit protection by means of both thermal and magnetic sensors.
- C. The circuit breaker calibration shall not be affected by environmental changes in relative humidity. The thermal bimetal element shall be welded to the steel frame and calibration shall be set independent of the molded case by computer controlled equipment.
- D. All circuit breakers shall be operated by a toggle-type handle and multipole circuit breakers shall have an internal common trip mechanism. The circuit breakers shall incorporate trip mechanisms that are mechanically trip-free from the handle. The handle position shall provide visual trip indication.
- E. Contacts shall be of non-welding silver alloy.
- F. All circuit breakers shall have the trip rating inscribed on the handle on each circuit breaker pole. Also, unique color-coded cases that indicate the UL listed 10 kA or 22 kA interrupting ratings. Breakers shall be able to be used as main or branch disconnect devices.
- G. Branch circuit breakers may also be used in the 1/2-inch (12.7 mm) per pole ratings that include two-pole 1-inch (25.4 mm) wide modules and four-pole 2-inch (50.8 mm) wide modules. Two-pole circuit breakers must incorporate a common trip mechanism.
- H. Circuit breakers shall be completely enclosed in a molded case of thermoset material. No internal aluminum parts shall be used. All internal ferrous parts shall be plated to prevent corrosion.
- I. All terminals shall be listed for use with copper or aluminum conductors. Terminals shall be of the box lug or clamp type design. The terminals shall meet UL 486B requirements and shall be suitable for use with either 60 °C or 75 °C wire.
- J. The calibrated bimetal assembly shall be mechanically isolated from the load terminal using a flexible braided copper shunt wire, such that movement of the terminals due to twisting and overtorquing does not affect breaker calibration.
- K. Breakers shall be SWD rated and/or HACR rated as required.
- L. Arc Fault Interrupting circuit breakers, (AFI), shall be provided on all 15 and 20 A single-phase 120/240 Vac circuits except those indicated as remote controlled breakers. AFI breakers shall be “Classified for mitigating the effects of arcing faults,” or conforming to UL Standard 1699 and as defined by Article 210.12 Section A of the 1999 NEC Code.

**Surge Protection Devices**

See Volume 1, Tab 2 for complete details on surge protection.

**Enclosures**

- A. Loadcenter shall have NEMA Type 1 general purpose or NEMA Type 3R rainproof enclosures as indicated on the drawings and shall be surface or combination flush/surface mounted except where noted.
- B. Boxes shall be made from galvanized sheet steel having multiple knockouts. Rainproof boxes shall use galvanized steel or an approved coating system which meets or exceeds standards for outdoor NEMA Type 3R enclosures. Boxes shall be of sufficient size to provide at least a minimum code gutter space on all sides.
- C. The deadfront shall have an easy adjustment feature for flush applications.
- D. Boxes shall be factory assembled into a single rigid structure.
- E. Unless otherwise noted on drawings, hinged doors covering all circuit breaker handles shall be included in all trims. Trim doors shall not uncover any live parts in making the circuit breaker handles accessible. If key locks are required, all locks shall be keyed alike.
- F. Combination trims for flush and surface panels shall be flat and shall overlap the box by at least 5/8-inch (15.9 mm) all around. Trims shall be mounted by a screwdriver without the need for special tools.

**Finish**

- A. Trims shall be bonderized and finished with a light gray ANSI-61 enamel. The paint finish shall be of a type to which field applied paint will adhere.

**Factory Testing**

- A. The standard factory tests shall be performed on the equipment provided under this section. All tests shall be in accordance with the latest version of UL and NEMA.

### BR Loadcenters

#### Description

#### Service

Single-phase, three-wire, 120/240 Vac

Three-phase, four-wire, 208Y/120 Vac  
Three-phase, three-wire, 240 Vac delta

#### Short-Circuit Current Rating

10 kAIC: All single- and three-phase loadcenters 70–225 A, 8 to 42 circuits  
22 kAIC: All convertible loadcenters using 125 A rated Type BRH main breakers or selected factory installed 125 A rated Type BRH main breaker

25 kAIC: All convertible and factory-installed single-phase loadcenters rated 150 and 200 A using Type CSR main breakers

#### Main Breaker/Main Lug Loadcenters

Single-phase  
Main breaker: 100, 125, 150, 200, 225, 400, 600 A  
Main lugs: 70, 125, 150, 200, 225, 400, 600 A

Three-phase  
Main breaker: 100, 125, 150, 200, 225, 400, 600 A  
Main lugs: 100, 125, 150, 200, 225, 400, 600 A

#### Convertible Loadcenters

Main breaker: single-phase up to 200 A and three-phase up to 225 A

Main lugs: single-phase up to 200 A and three-phase up to 150 A

#### Branch Breakers

Types BR, BRH and BRHH: 10–150 A, single-, two- and three-pole; selected amperage available in switching duty, HACR, shunt trip and high magnetic setting  
Type GFTCB: 15–60 A  
Types BJ and BJH: 125–225 A; two- and three-pole  
Type BD Twin: 10–50 A; two of one-pole; take one 1-inch (25.4 mm) space

Type BQ and BQC Multibreaker: 15–30 A. Two of two-pole or one two-pole and two one-pole; takes two 1-inch (25.4 mm) spaces  
Type BRW: 15–30 A; two-pole water heater breakers  
Type BRSN: 15–30 A; two-pole switching neutral breakers  
Type BR 15–100 A; two-pole, 240 Vac delta breakers  
BR-AFCl arc fault circuit interrupter

#### Enclosures

NEMA Type 1 indoor  
NEMA Type 3R outdoor

NEMA 4X  
Meets or exceeds UL requirements for indoor or outdoor applications

#### Loadcenter and Breaker Accessories

Branch circuit breaker:  
Auxiliary components    Hold-down kits    Handle ties  
Lockoffs                    Lockdogs  
Complete line of ground bar kits 5, 10, 14 and 21 circuit, some with additional #2/0 lugs; each terminal will accommodate: (3) #14–#10 Cu/Al or (1) #14–#4 Cu/Al  
Main and sub-feed lugs 125, 150, 225 A—two- and three-pole  
Shunt trips

Surge protection:  
Single-phase plug-on surge protector    Single-phase bottle type surge protector  
Three-phase bottle type surge protector    Single-phase whole home surge protector  
Universal rainproof conduit hubs  
Group One: 3/4, 1, 1-1/4, 1-1/2, 2 inches (19.1, 25.4, 31.8, 38.1, 50.8 mm)  
Group Two: 2, 2-1/2, 3 inches (50.8, 63.5, 76.2 mm)  
Adapter plate

#### Bussing

Tin-plated aluminum as standard

Limited copper bus panels available

**Dimensions**

Approximate Dimensions in Inches (mm)

**Residential/Commercial/New York City Loadcenters, Unit Enclosures—Box Sizes****Note:** Box sizes do not include covers/fronts.**Residential Loadcenters—NEMA Type 1 Indoor**

Box Size	Height	Width	Depth
A1	15.00 (381.0)	11.25 (285.8)	3.75 (95.3)
B1	16.75 (425.5)	14.31 (363.5)	3.88 (98.4)
B2	18.75 (476.3)	14.31 (363.5)	3.88 (98.4)
C1	21.00 (533.4)	14.31 (363.5)	3.88 (98.4)
C2	23.00 (584.2)	14.31 (363.5)	3.88 (98.4)
C4	27.00 (685.8)	14.31 (363.5)	3.88 (98.4)
D1	29.13 (739.8)	14.31 (363.5)	3.88 (98.4)
G1	34.13 (866.8)	14.31 (363.5)	3.88 (98.4)
L1	39.00 (990.6)	14.31 (363.5)	3.88 (98.4)
L2	45.00 (1143.0)	14.31 (363.5)	3.88 (98.4)
L3	48.38 (1228.3)	14.31 (363.5)	3.88 (98.4)
2	8.63 (219.1)	5.00 (127.0)	3.50 (88.9)
3	9.44 (239.7)	4.50 (114.3)	3.00 (76.2)
4	13.00 (330.2)	11.00 (279.4)	3.56 (90.5)
5	9.44 (239.7)	4.50 (114.3)	3.00 (76.2)
6	12.00 (304.8)	6.88 (174.6)	4.50 (114.3)
7	13.00 (330.2)	11.00 (279.4)	3.56 (90.5)
9	14.50 (368.3)	6.50 (165.1)	3.50 (88.9)

**Residential Loadcenters—NEMA Type 3R Outdoor**

Box Size	Height	Width	Depth
B1R	16.75 (425.5)	14.31 (363.5)	5.19 (131.8)
B2R	18.75 (476.3)	14.31 (363.5)	5.19 (131.8)
C3R	25.00 (635.0)	14.31 (363.5)	5.19 (131.8)
D1R	29.13 (739.8)	14.31 (363.5)	5.19 (131.8)
G1R	34.13 (866.8)	14.31 (363.5)	5.19 (131.8)
L1R	39.00 (990.6)	14.31 (363.5)	5.19 (131.8)
L2R	45.00 (1143.0)	14.31 (363.5)	5.19 (131.8)
L3R	48.75 (1238.2)	14.31 (363.5)	5.19 (131.8)
2R	8.63 (219.1)	5.00 (127.0)	3.50 (88.9)
3R	9.44 (239.7)	4.50 (114.3)	3.00 (76.2)
4R	13.00 (330.2)	11.00 (279.4)	3.56 (90.5)
5R	9.44 (239.7)	4.50 (114.3)	3.00 (76.2)
6R	11.75 (298.5)	6.50 (165.1)	4.50 (114.3)
7R	13.00 (330.2)	11.00 (279.4)	3.56 (90.5)
8R	27.00 (685.8)	10.50 (266.7)	4.75 (120.7)
9R	14.25 (362.0)	6.50 (165.1)	4.00 (101.6)
C1R	21.00 (533.4)	14.31 (363.5)	5.19 (131.8)

**Residential Loadcenters—NEMA Type 1 Indoor (BR Plug-On Neutral)**

Box Size	Height	Width	Depth
X0	16.90 (429.3)	14.30 (363.2)	3.80 (96.5)
X1	18.90 (480.1)	14.30 (363.2)	3.80 (96.5)
X2	21.10 (535.9)	14.30 (363.2)	3.80 (96.5)
X3	23.10 (586.7)	14.30 (363.2)	3.80 (96.5)
X4	27.10 (688.3)	14.30 (363.2)	3.80 (96.5)
X5	29.20 (741.7)	14.30 (363.2)	3.80 (96.5)
X6	34.20 (868.7)	14.30 (363.2)	3.80 (96.5)
X7	37.10 (942.3)	14.30 (363.2)	3.80 (96.5)
X8	39.10 (993.1)	14.30 (363.2)	3.80 (96.5)
X9	45.10 (1145.5)	14.30 (363.2)	3.80 (96.5)
X10	48.60 (1234.4)	14.30 (363.2)	3.80 (96.5)

**Commercial Loadcenters—NEMA Type 1 Indoor**

Box Size	Height	Width	Depth
19	44.00 (1117.6)	16.16 (410.4)	6.25 (158.8)
20	44.00 (1117.6)	16.16 (410.4)	6.25 (158.8)
22	54.00 (1371.6)	16.22 (412.0)	6.31 (160.3)
24	66.50 (1689.1)	16.22 (412.0)	6.31 (160.3)

**Commercial Loadcenters—NEMA Type 3R Outdoor**

Box Size	Height	Width	Depth
42	38.00 (965.2)	16.31 (414.3)	6.38 (161.9)
43	44.00 (1117.6)	16.31 (414.3)	6.38 (161.9)
46	54.00 (1371.6)	16.31 (414.3)	6.38 (161.9)
47	66.56 (1690.7)	16.31 (414.3)	6.38 (161.9)

**New York City Loadcenters—NEMA Type 1 Indoor**

Box Size	Height	Width	Depth
A	38.00 (965.2)	18.13 (460.4)	5.00 (127.0)
B	44.00 (1117.6)	18.13 (460.4)	5.00 (127.0)
C	66.50 (1689.1)	18.13 (460.4)	6.25 (158.8)

**ECC Unit Enclosures—NEMA Type 1 Indoor**

Height	Width	Depth
23.25 (590.6)	8.88 (225.4)	4.50 (114.3)

**ECC Unit Enclosures—NEMA Type 3R Outdoor**

Height	Width	Depth
23.68 (601.7)	9.31 (236.5)	5.44 (138.1)

Approximate Dimensions in Inches (mm)

### Residential Loadcenter Knockouts

#### Knockouts for Box Sizes A1, B1, B2, C1, C2, C4, D1, G1, L1, L2, B1R, B2R, C1R, C3R, D1R, G1R, L1R, L2R

Code	Diameter				
A	0.50 (12.7)	0.75 (19.1)	—	—	—
B	0.50 (12.7)	—	—	—	—
C	0.50 (12.7)	1.25 (31.8)	1.50 (38.1)	2.00 (50.8)	2.50 (63.5)
D	1.25 (31.8)	1.25 (31.8)	2.00 (50.8)	2.50 (63.5)	—
E	0.50 (12.7)	0.75 (19.1)	1.00 (25.4)	—	—
F	0.50 (12.7)	0.75 (19.1)	1.00 (25.4)	1.50 (38.1)	2.00 (50.8)
G	1.25 (31.8)	1.50 (38.1)	2.00 (50.8)	—	—
H	0.50 (12.7)	0.75 (19.1)	1.00 (25.4)	1.25 (31.8)	1.50 (38.1)
I	1.00 (25.4)	1.25 (31.8)	1.50 (38.1)	2.00 (50.8)	2.50 (63.5)
J	1.00 (25.4)	1.25 (31.8)	1.50 (38.1)	—	—

#### Residential NEMA Type 1 Indoor and NEMA Type 3R Outdoor Enclosures

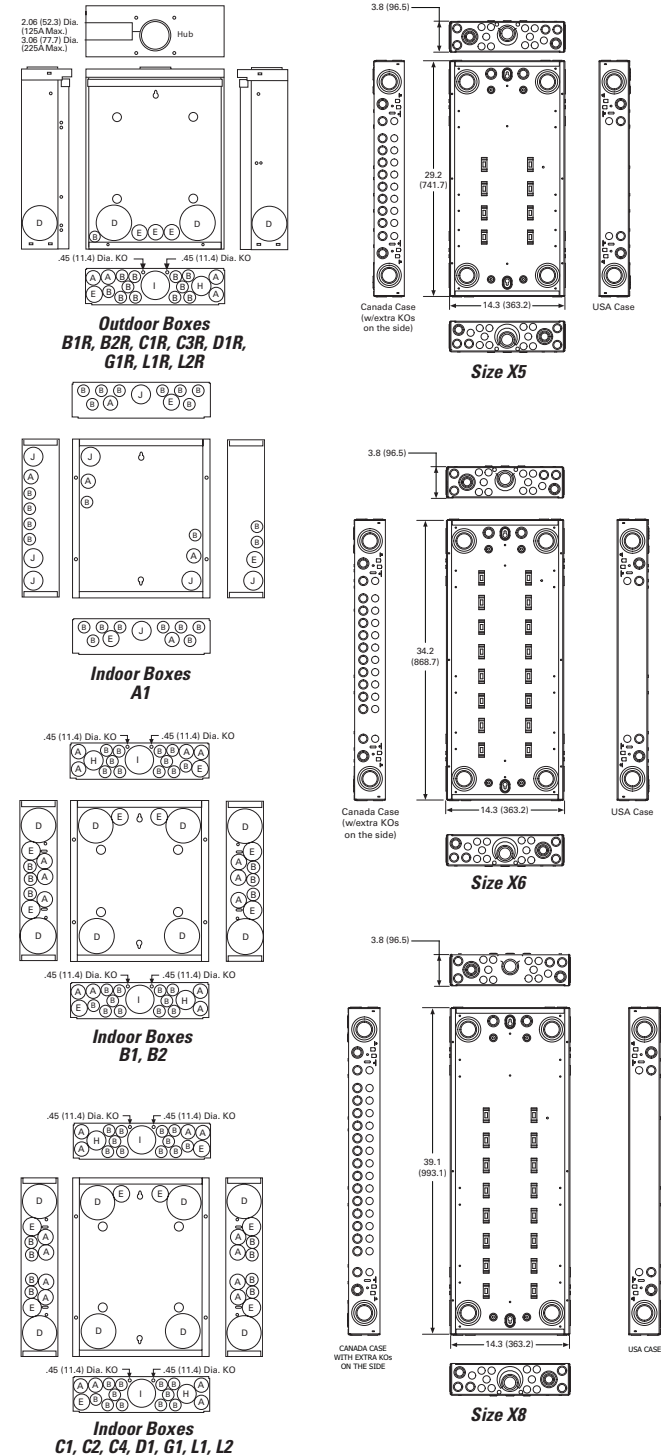

# 1.2

## Loadcenters and Circuit Breakers

### Type BR Loadcenters and Circuit Breakers

1

Approximate Dimensions in Inches (mm)

#### Knockouts for Box Sizes 3, 4, 5, 6, 7, 9, 2R, 3R, 4R, 5R, 6R, 7R, 8R, 9R

Code	Diameter			
A	0.50 (12.7)	—	—	—
B	0.50 (12.7)	0.75 (19.1)	—	—
C	0.50 (12.7)	0.75 (19.1)	1.00 (25.4)	—
D	0.50 (12.7)	0.75 (19.1)	1.00 (25.4)	1.25 (31.8)
E	0.75 (19.1)	1.00 (25.4)	1.25 (31.8)	—
F	0.75 (19.1)	1.00 (25.4)	1.25 (31.8)	1.50 (38.1)
G	1.00 (25.4)	1.25 (31.8)	1.50 (38.1)	—
H	1.00 (25.4)	1.25 (31.8)	1.50 (38.1)	2.00 (50.8)
I	1.25 (31.8)	1.50 (38.1)	2.00 (50.8)	—

#### Residential NEMA Type 1 Indoor and NEMA Type 3R Outdoor Enclosures

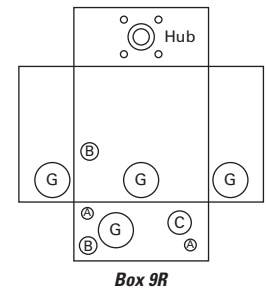
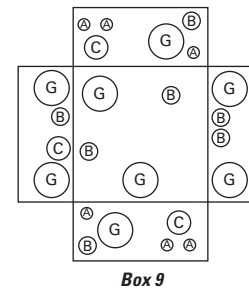
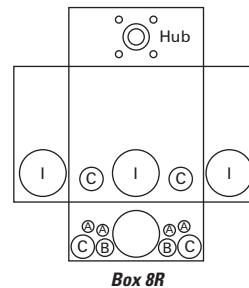
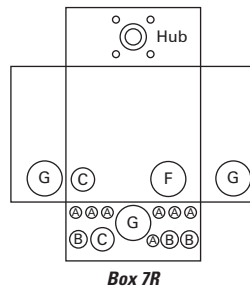
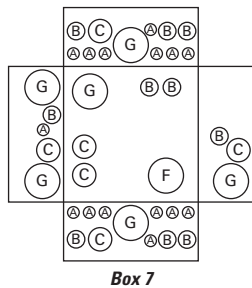
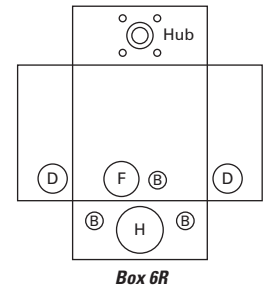
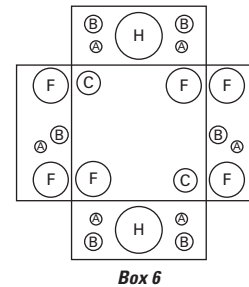
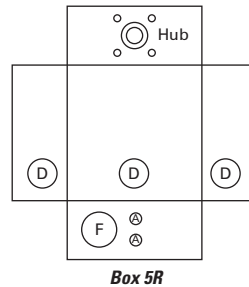
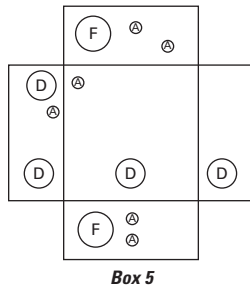
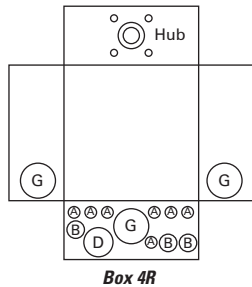
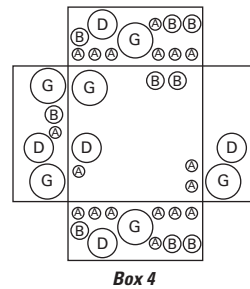
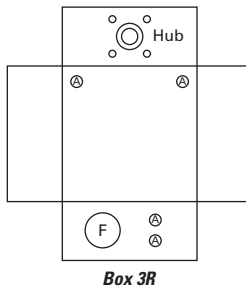
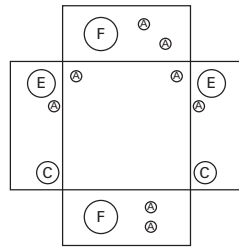
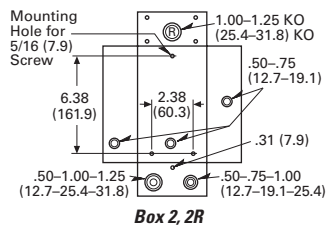

Approximate Dimensions in Inches (mm)

### Commercial Loadcenter Knockouts

#### NEMA Type 1 Indoor Commercial Enclosures Knockouts for Box Sizes 19, 20, 22, 24

Code	Diameter			
A	0.50 (12.7)	—	—	—
B	0.50 (12.7)	0.75 (19.1)	—	—
C	0.75 (19.1)	1.00 (25.4)	1.50 (38.1)	—
D	1.50 (38.1)	2.00 (50.8)	2.50 (63.5)	3.00 (76.2)
E	2.00 (50.8)	2.50 (63.5)	3.00 (76.2)	—
F	2.50 (63.5)	3.00 (76.2)	3.50 (88.9)	—

#### NEMA Type 3R Outdoor Commercial Enclosures Knockouts for Box Sizes 42, 43, 46, 47

Code	Diameter			
A	0.50 (12.7)	—	—	—
B	0.50 (12.7)	0.75 (19.1)	—	—
C	0.75 (19.1)	1.00 (25.4)	1.25 (31.8)	—
D	1.50 (38.1)	2.00 (50.8)	2.50 (63.5)	—
E	2.00 (50.8)	2.50 (63.5)	3.00 (76.2)	—
F	2.50 (63.5)	3.00 (76.2)	3.50 (88.9)	—
G	1.25 (31.8)	1.50 (38.1)	2.00 (50.8)	2.50 (63.5)
H	3.25 (82.6) Sq.	—	—	—

### Unit Enclosure Knockouts, Types ECB and ECC Knockouts

Code	Diameter			
<b>NEMA Type 1 Indoor (Flush and Surface Trims)</b>				
A	0.50 (12.7)	—	—	—
B	1.25 (31.8)	1.50 (38.1)	1.75 (44.5)	2.00 (50.8)
<b>NEMA Type 3R Outdoor</b>				
A	0.50 (12.7)	—	—	—
B	1.25 (31.8)	1.50 (38.1)	1.75 (44.5)	2.00 (50.8)

### Indoor Commercial Enclosures

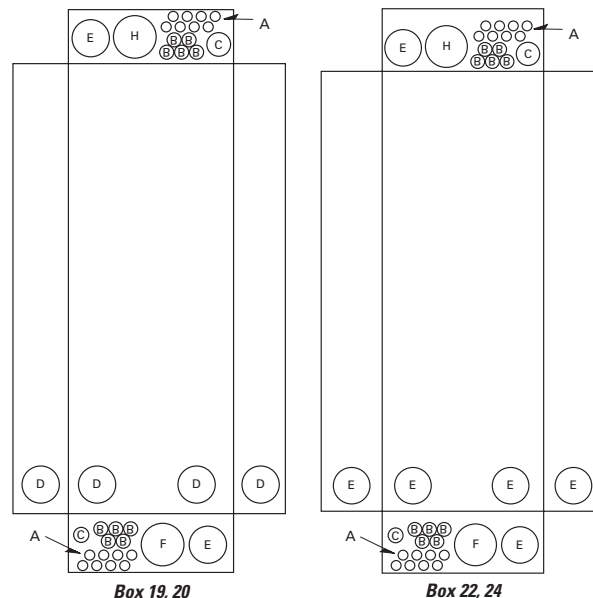

### Outdoor Commercial Enclosures

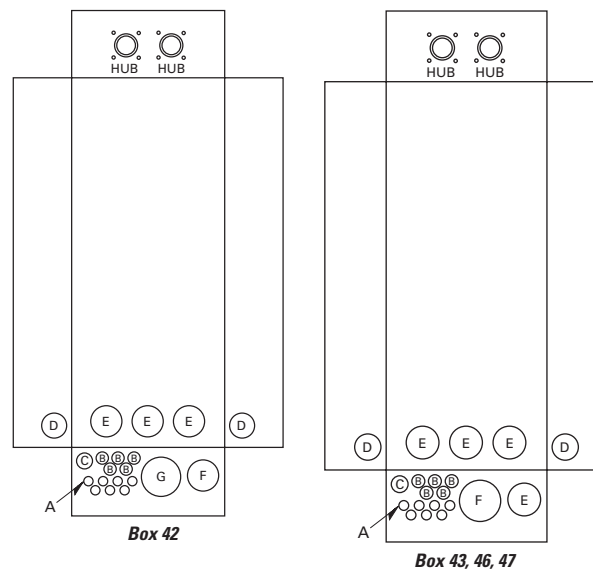

### Unit Enclosure Knockouts

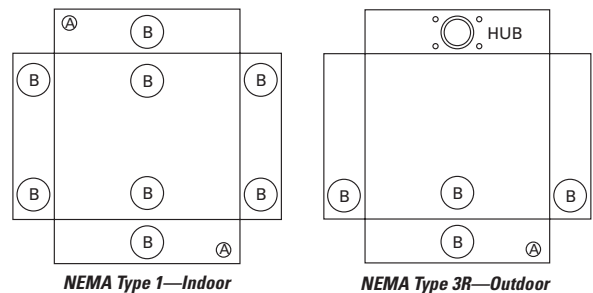



**BR Circuit Breakers**



**Contents**

<i>Description</i>	<i>Page</i>
Overview . . . . .	<b>V1-T1-42</b>
BR Specialty Products	
BR Plug-On Neutral Loadcenters . . . . .	<b>V1-T1-57</b>
BR Quick Connect Neutral Loadcenters . . . . .	<b>V1-T1-60</b>
Spa Panels . . . . .	<b>V1-T1-61</b>
Riser Panel . . . . .	<b>V1-T1-62</b>
Type BR Renovation Loadcenter . . . . .	<b>V1-T1-63</b>
BR Loadcenter Options and Accessories	
Type BR Retrofit Interior Kits . . . . .	<b>V1-T1-64</b>
Type BR Mechanical Interlock Kits . . . . .	<b>V1-T1-68</b>
BR Circuit Breakers	
Product Selection . . . . .	<b>V1-T1-81</b>
Options and Accessories . . . . .	<b>V1-T1-88</b>
Wiring Diagrams . . . . .	<b>V1-T1-90</b>

**BR Circuit Breakers**

**Product Description**

**Plug-On Branch Feeder Type Arc Fault Circuit Breakers, Type BR—10 kAIC, 120 Vac and 120/240 Vac**

A branch feeder type arc fault circuit interrupter is a device intended to mitigate high current arcing faults in the complete circuit, including connected cords. High current arcing faults can occur from line to neutral or line to ground. These arcing faults are in parallel with the load and produce the most energy of all arcing faults.

The branch feeder type AFCI is required in the 1999 and 2002 National Electrical Code.

The Combination Type AFCI is required in the 2005, 2008, and 2011 National Electrical Code.

**Plug-On Combination Type Arc Fault Circuit Breakers, Type BR—10 kAIC, 120 Vac and 120/240 Vac**

A combination type arc fault circuit interrupter is a device that includes all of the protection offered by the branch feeder AFCI (mitigation of high current arcing faults in the complete circuit, including connected cords). In addition it provides direct detection of persistent low current arcing faults down to 5 amps with associated mitigation of fire hazards in the cords connected to the outlets. High current arcing faults can occur from line to neutral or line to ground. These arcing faults are in parallel with the load and produce the most energy of all arcing faults. The current level of low current arcing faults is limited by the load.

**Plug-On Ground Fault Circuit Breakers, Type GFTCB and GFEP—10/22 kAIC, 120 Vac and 120/240 Vac**

**Ground Fault Application Notes**

Single-pole GFTCBs are designed for use in two-wire, 120 Vac circuits. See **Page V1-T1-90** for a typical wiring configuration.

Two-pole GFTCBs are designed for use in three-wire, 120/240 Vac circuits, 120 Vac multiwire circuits employing common, neutral and two-wire, 240 Vac circuits obtained from a 120/240 Vac source.

**Page V1-T1-90** shows typical wiring configurations for a 120/240 Vac multiwire circuits, and a 240 Vac, two-wire circuit. Note the “panel neutral” conductor connects to the neutral bar, even though the neutral is not included in the load circuit. This connection is necessary to supply a 120 Vac power source to the ground fault sensing circuit.

The figures are shown with a 120/240 Vac, single-phase, three-wire power source, but are also applicable to a 120/208 Vac, three-phase, four-wire power supply.

For all figures, the electrical operation of the GFTCB is not affected by the equipment ground.

**Non-CTL Plug-On Replacement—Circuit Breakers, Type BRD—10 kAIC, 120/240 Vac**

**Non-CTL 10 kAIC for Replacement Purposes Only**

For replacement in enclosures manufactured prior to 1968 with unnotched stabs. Circuit breakers do not have rejection tab.

### Product Selection

#### Plug-On Circuit Breakers, Types BR—10/22/42 kAIC, 120 Vac, 120/240 Vac and 240 Vac

BR120



BR215



BR320



BRH2100



BRX2125



#### Type BR Breakers, 1-Inch (25.4 mm) per Pole 120/240, 10, 22 and 42 kAIC

Ampere Rating	Wire Size Range Cu/Al 60 °C or 75 °C	Single-Pole 120/240 Vac Requires One 1-Inch (25.4 mm) Space 10 per Shelf Carton		Two-Pole 120/240 Vac Common Trip Requires Two 1-Inch (25.4 mm) Spaces 5 per Shelf Carton		42 kAIC		65 kAIC	
		10 kAIC Catalog Number	22 kAIC Catalog Number	10 kAIC Catalog Number	22 kAIC Catalog Number	Catalog Number	Catalog Number	Catalog Number	Catalog Number
10	#14–4	BR110	—	BR210	—	—	—	—	—
15	#14–4	BR115 ①②	BRH115	BR215 ③	BRH215	—	—	—	—
20	#14–4	BR120 ①②	BRH120	BR220 ③	BRH220	—	—	—	—
25	#14–4	BR125	BRH125	BR225 ③	BRH225	—	—	—	—
30	#14–4	BR130	BRH130	BR230 ③	BRH230	—	—	—	—
35	#14–4	BR135	BRH135	BR235 ③	BRH235	—	—	—	—
40	#14–4	BR140	BRH140	BR240 ③	BRH240 ③	—	—	—	—
45	#14–4	—	BRH145	BR245 ③	BRH245	—	—	—	—
50	#14–4	BR150	BRH150	BR250 ③	BRH250 ③	—	—	—	—
55	#14–3	BR150	BRH155	BR255	BRH255	—	—	—	—
60	#8–1/0	BR160	BRH160	BR260	BRH260	BRHH260	BRX260	—	—
70	#8–1/0	BR170	BRH170	BR270	BRH270	BRHH270	BRX270	—	—
80	#8–1/0	—	—	BR280	BRH280	BRHH280	BRX280	—	—
90	#8–1/0	—	—	BR290	BRH290	BRHH290	BRX290	—	—
100	#8–1/0	—	—	BR2100	BRH2100	BRHH2100	BRX2100	—	—
110	#8–1/0	—	—	BR2110	BRH2110	BRHH2110	BRX2110	—	—
125	#4–2/0	—	—	BR2125	BRH2125	BRHH2125	BRX2125	—	—
150	#4–2/0	—	—	BR2150 ④	—	—	—	—	—



#### Notes

- ① One pole, 1-inch (25.4 mm) per pole circuit breakers are available with high magnetic setting for switching large tungsten lamp loads. Add suffix H to catalog number.
- ② Switching duty rated.
- ③ On the black handle breaker, add suffix “B” to the catalog number to obtain a tapped molded opening for proper use with hold-down kits.
- ④ For use as a branch circuit breaker in 400 and 600 ampere panels only.

All Type BR single-, two- and three-pole circuit breakers carry listing for HACR application. For circuit breakers with a shunt trip, add ST suffix.

BR Breakers



**Type BR Breakers, 1-Inch (25.4 mm) per Pole 240 Vac, 10, 22 and 42 kAIC**

Three-Pole 240 Vac  
Common Trip Requires Three  
1-Inch (25.4 mm) Spaces  
5 per Shelf Carton



Ampere Rating	Wire Size Range Cu/Al 60 °C or 75 °C	10 kAIC Catalog Number	22 kAIC Catalog Number
10	#14-4	BR310	—
15	#14-4	BR315 ①	BRH315
20	#14-4	BR320 ①	BRH320
25	#14-4	BR325	BRH325
30	#14-4	BR330	BRH330
35	#14-4	BR335	BRH335
40	#14-4	BR340	BRH340
45	#14-4	BR345	BRH345
50	#14-4	BR350	BRH350
55	#14-3	BR355	BRH355
60	#4-1/0	BR360	BRH360
70	#4-1/0	BR370	BRH370
80	#4-1/0	BR380	BRH380
90	#4-1/0	BR390	BRH390
100	#4-1/0	BR3100	BRH3100

**Plug-On, Dual Purpose Arc Fault / Ground Fault Circuit Breakers, Type BR—10 kAIC, 120 Vac**

BRLAFGF115



**Type BR, 1-Inch (25.4 mm) wide Dual Purpose AF/GF Circuit Breakers ②③**

Poles	Ampere Rating	Configuration	Catalog Number
Single-pole 10 kAIC	15	Combination AFGI / GFCl	BRLAFGF115 ④
			BRAFGF115 ⑤
	20		BRLAFGF120 ④
			BRAFGF120 ⑤
Single-pole 22 kAIC	15	BRHAFGF115 ⑤	
	20	BRHAFGF120 ⑤	

**Plug-On Combination Type Arc Fault Circuit Breakers, Type BR—10 kAIC, 120 Vac and 120/240 Vac**

BRCAF115



**Type BR, 1-Inch (25.4 mm) wide Combination Type AFCI Circuit Breakers**

Poles	Ampere Rating	Configuration	Catalog Number
Single-pole 10 kAIC	15	AFCI	BRCAF115 ⑥
	20	AFCI	BRCAF120 ⑥
Single-pole 22 kAIC	15	AFCI	BRHCAF115 ⑥
	20	AFCI	BRHCAF120 ⑥
Two-pole 10 kAIC	15	AFCI	BRL215CAF
	20	AFCI	BRL220CAF

**Notes**

- ① One pole, 1-inch (25.4 mm) per pole circuit breakers are available with high magnetic setting for switching large tungsten lamp loads. Add suffix H to catalog number.
  - ② Breaker qualifies as combination arc fault, per UL 1699.
  - ③ Breaker qualifies as personnel protection ground fault, (5 mA) per UL 943.
  - ④ These catalog numbers will be obsoleted in Q3, 2018 and replaced with BRAFGF short body breakers.
  - ⑤ Short body replacing BRLAFGF breakers.
  - ⑥ Clamshell packaging available with CS modification code on the end of catalog number.
- All Type BR single-, two- and three-pole circuit breakers carry listing for HACR application. For circuit breakers with a shunt trip, add ST suffix. See **Volume 4** for bolt-on AF/GF breakers; QB1015AFGF, QB1020AFGF, QBH1015AFGF and QBH1020AFGF.

### Plug-On Ground Fault Circuit Breakers, Type GFTCB and GFEP—10/22 kAIC, 120 Vac and 120/240 Vac

Type GFTCB Single-Pole



Type GFTCB Two-Pole



#### Type GFTCB Ground Fault Circuit Breakers—5 Milliampere—1-Inch (25.4 mm) per Pole 120 Vac or 120/240 Vac, 10 kAIC

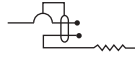

Single-Pole 120 Vac  
Requires One  
1-Inch (25.4 mm) Space  
1 per Shelf Carton  
Catalog Number ①



Two-Pole 120/240 Vac  
Common Trip Requires Two  
1-Inch (25.4 mm) Spaces  
1 per Shelf Carton  
Catalog Number

Ampere Rating	Wire Size Range Cu/Al 60 °C or 75 °C	Single-Pole 120 Vac Requires One 1-Inch (25.4 mm) Space 1 per Shelf Carton Catalog Number ①	Two-Pole 120/240 Vac Common Trip Requires Two 1-Inch (25.4 mm) Spaces 1 per Shelf Carton Catalog Number
15	#14–4	GFTCB115	GFTCB215
20	#14–4	GFTCB120	GFTCB220
25	#14–4	GFTCB125	GFTCB225
30	#14–4	GFTCB130	GFTCB230
40	#14–4	GFTCB140	GFTCB240
50	#14–4	—	GFTCB250 ②
60	#14–6	—	GFTCB260

#### Type GFTCBH Ground Fault Breakers—5 Milliampere—1-Inch (25.4 mm) per Pole 120 Vac or 120/240 Vac, 22 kAIC

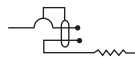

Single-Pole 120 Vac  
Requires One  
1-Inch (25.4 mm) Space  
1 per Shelf Carton  
Catalog Number



Two-Pole 120/240 Vac  
Common Trip Requires Two  
1-Inch (25.4 mm) Spaces  
1 per Shelf Carton  
Catalog Number

Ampere Rating	Wire Size Range Cu/Al 60 °C or 75 °C	Single-Pole 120 Vac Requires One 1-Inch (25.4 mm) Space 1 per Shelf Carton Catalog Number	Two-Pole 120/240 Vac Common Trip Requires Two 1-Inch (25.4 mm) Spaces 1 per Shelf Carton Catalog Number
15	#14–4	GFTCBH115	GFTCBH215
20	#14–4	GFTCBH120	GFTCBH220
25	#14–4	GFTCBH125	GFTCBH225
30	#14–4	GFTCBH130	GFTCBH230

#### Type GFEP Ground Fault Equipment Protectors—30 Milliampere—1-Inch (25.4 mm) per Pole 120 Vac or 120/240 Vac, 10 kAIC

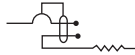

Single-Pole 120 Vac  
Requires One  
1-Inch (25.4 mm) Space  
1 per Shelf Carton  
Catalog Number



Two-Pole 120/240 Vac  
Common Trip Requires Two  
1-Inch (25.4 mm) Space  
1 per Shelf Carton  
Catalog Number

Ampere Rating	Wire Size Range Cu/Al 60 °C or 75 °C	Single-Pole 120 Vac Requires One 1-Inch (25.4 mm) Space 1 per Shelf Carton Catalog Number	Two-Pole 120/240 Vac Common Trip Requires Two 1-Inch (25.4 mm) Space 1 per Shelf Carton Catalog Number
15	#14–4	GFEP115	GFEP215
20	#14–4	GFEP120	GFEP220
25	#14–4	GFEP125	GFEP225
30	#14–4	GFEP130	GFEP230
40	#14–4	—	GFEP240
50	#14–4	—	GFEP250 ②

#### Notes

- ① Available with bell alarm or auxiliary switch. See circuit breaker accessories on [Page V1-T1-88](#).
- ② For use with copper wire only.

# 1.2

## Loadcenters and Circuit Breakers

### Type BR Loadcenters and Circuit Breakers

1

#### CTL Plug-On Circuit Breakers, Type BD Duplex, BQ and BQC Quadplex—10 kAIC, 120/240 Vac

BD2020

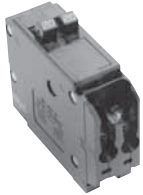

Type BD Duplex  
(UL Type BRD)

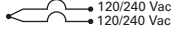

Single-Pole ①  
Requires One 1-Inch  
(25.4 mm) Space  
10 per Shelf Carton

BQ2302115

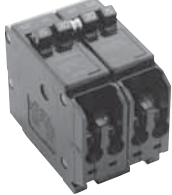

Type BQ Quadplex Independent Trip  
(UL Type BRD)

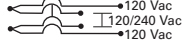

Two-Pole ② and Single-Pole ①  
Requires Two 1-Inch  
(25.4 mm) Spaces  
5 per Shelf Carton

Type BQ Quadplex Independent Trip  
(UL Type BRD)

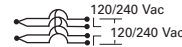

Two-Pole  
Requires Two 1-Inch  
(25.4 mm) Spaces  
5 per Shelf Carton  
120/240 Vac

BQ230230

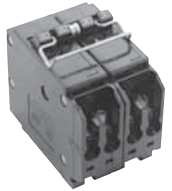

Ampere Rating	Catalog Number	Wire Size Range Cu/Al 65 °C or 75 °C	Ampere Rating			Catalog Number	Ampere Rating		
			Outer Left Single-Pole	Center Two-Pole Independent Trip	Outer Right Single-Pole		Outer Two-Pole Independent Trip	Center Two-Pole Independent Trip	Catalog Number
10–10	<b>BD1010</b>	#14–4	15	20	15	<b>BQ2202115</b>	15	15	<b>BQ215215</b>
15–15	<b>BD1515</b>	#14–4	20	20	20	<b>BQ2202120</b>	15	20	<b>BQ215220</b>
15–20	<b>BD1520</b>	#14–4	15	30	15	<b>BQ2302115</b>	15	30	<b>BQ215230</b>
15–30	<b>BD1530</b>	#14–4	20	30	20	<b>BQ2302120</b>	15	40	<b>BQ215240</b>
20–15	<b>BD2015</b>	#14–4	15	40	15	<b>BQ2402115</b>	15	50	<b>BQ215250</b>
20–20	<b>BD2020</b>	#14–4	20	40	20	<b>BQ2402120</b>	20	20	<b>BQ220220</b>
20–30	<b>BD2030</b>	#14–4	15	50	15	<b>BQ2502115</b>	20	30	<b>BQ220230</b>
25–25	<b>BD2525</b>	#14–4	20	50	20	<b>BQ2502120</b>	20	40	<b>BQ220240</b>
30–15	<b>BD3015</b>	#14–4	—	—	—	—	20	50	<b>BQ220250</b>
30–20	<b>BD3020</b>	#14–4	—	—	—	—	25	25	<b>BQ225225</b>
30–30	<b>BD3030</b>	#14–4	—	—	—	—	30	30	<b>BQ230230</b>
30–40	<b>BD3040</b>	#14–4	—	—	—	—	30	40	<b>BQ230240</b>
30–50	<b>BD3050</b>	#14–4	—	—	—	—	30	50	<b>BQ230250</b>
50–30	<b>BD5030</b>	#14–4	—	—	—	—	40	40	<b>BQ240240</b>
50–50	<b>BD5050</b>	#14–4	—	—	—	—	40	50	<b>BQ240250</b>
—	—	—	—	—	—	—	50	50	<b>BQ250250</b>

#### Notes

- ① All 15 and 20 A single poles are switch-duty rated.
- ② All Type BD duplex and BQ quadplex circuit breakers carry listing for HACR applications.
- ③ Available with bell alarm or auxiliary switch. See circuit breaker accessories on [Page V1-T1-88](#).
- ④ For use with copper wire only.

### Non-CTL Plug-On Replacement—Circuit Breakers, Type BRD—10 kAIC, 120/240 Vac

BR2020

#### Class Non-CTL, 1-Inch (25.4 mm) per Pole 10 kAIC—Breakers Do Not Have Rejection Tab Feature



##### Type BR Duplex

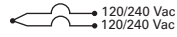

Single-Pole Requires One 1-Inch (25.4 mm) Space  
10 per Shelf Carton

##### Type Brand BRD Quadplex Independent Trip

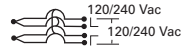

Two-Pole Requires Two 1-Inch (25.4 mm) Spaces  
5 per Shelf Carton

##### Type BRD Quadplex Common Trip Center and Outer Poles

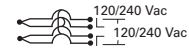

Two-Pole Requires Two 1-Inch (25.4 mm) Spaces  
5 per Shelf Carton

Ampere Rating	120 Vac		120/240 Vac		Catalog Number	120/240 Vac		Catalog Number
	Ampere Rating	Wire Size Range Cu/Al 65 °C or 75 °C	Ampere Rating	Center Two-Pole Independent Trip		Ampere Rating	Center Two-Pole Common Trip	
15-15	BR1515	#14-4	15	15	BR415	15	15	BRDC215215
15-20	BR1520	#14-4	20	20	BR420	30	30	BRDC230230
20-15	BR2015	#14-4	30	30	BR430	30	40	BRDC230240
20-20	BR2020	#14-4	20	30	BRD220230	30	50	BRDC230250
30-30	BR3030	#14-4	30	40	BRD230240	—	—	—
30-50	BR3050	#14-4	30	50	BRD230250	—	—	—

#### CTL and Non-CTL Breakers

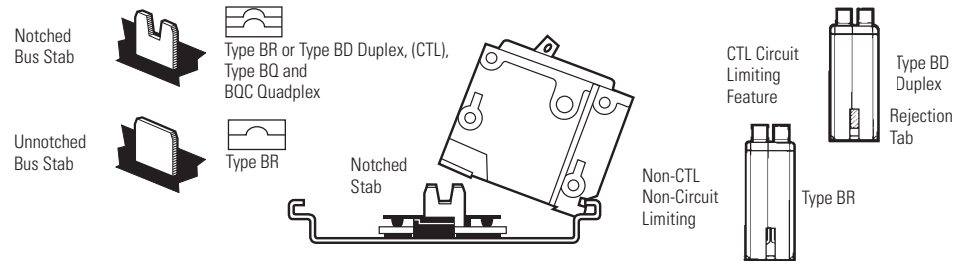

#### 1

#### Common Trip Quadplex Breakers

BQC2302115

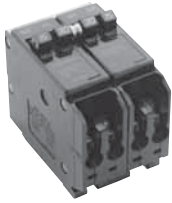

#### Class CTL, 1-Inch (25.4 mm) per Pole 10 kAIC—All Circuit Breakers Have Rejection Tab Feature

Type BQC Quadplex Common Trip Center Poles (UL Type BRD)

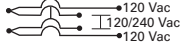

Two-Pole ① and Single-Pole ②  
Requires Two 1-Inch (25.4 mm) Spaces  
5 per Shelf Carton

120 Vac      120/240 Vac      120 Vac

BQC2302115

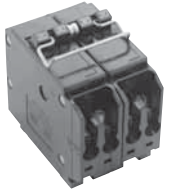

Type BQC Quadplex Common Trip Center and Outer Poles (UL Type BRD)

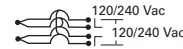

Two-Pole ①  
Requires Two 1-Inch (25.4 mm) Spaces  
5 per Shelf Carton

120/240 Vac

Ampere Rating		Wire Size Range			Ampere Rating		
Outer Left Single-Pole	Center Two-Pole Common Trip	Outer Right Single-Pole	Catalog Number	Cu/Al 65 °C or 75 °C	Outer Two-Pole Common Trip	Center Two-Pole Common Trip	Catalog Number
15	20	15	BQC2202115	#14–4	15	15	BQC215215
15	25	15	BQC2252115	#14–4	15	20	BQC215220
15	30	15	BQC2302115	#14–4	15	30	BQC215230
15	40	15	BQC2402115	#14–4	20	15	BQC220215
15	50	15	BQC2502115	#14–4	20	20	BQC220220
—	—	—	—	#14–4	20	30	BQC220230
—	—	—	—	#14–4	20	40	BQC220240
—	—	—	—	#14–4	20	50	BQC220250
20	15	20	BQC2152120	#14–4	25	25	BQC225225
20	20	20	BQC2202120	#14–4	25	30	BQC225230
20	25	20	BQC2252120	#14–4	30	15	BQC230215
20	30	20	BQC2302120	#14–4	30	30	BQC230230
20	40	20	BQC2402120	#14–4	30	40	BQC230240
20	50	20	BQC2502120	#14–4	30	50	BQC230250
30	50	20	BQC2502030	#14–4	40	30	BQC240230
—	—	—	—	#14–4	40	40	BQC240240
—	—	—	—	#14–4	40	50	BQC240250
—	—	—	—	#14–4	50	20	BQC250220
—	—	—	—	#14–4	50	50	BQC250250

#### Notes

- ① All Type BQC quadplex circuit breakers carry listing for HACR applications.
- ② All 15 and 20 ampere single poles are switch-duty rated.

### Plug-On Circuit Breakers, Types BJ and BJH—10/22 kAIC, 120/240 Vac and 240 Vac

For Use in Single-Phase and Three-Phase Loadcenters—150 Amperes and Above

#### Type BJ

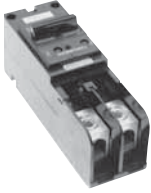

### Types BJ and BJH Breakers, 1-Inch (25.4 mm) per Pole, 120/240 or 240 Vac, 10, 22 kAIC



**Two-Pole 120/240 Vac**  
Common Trip Requires Four  
1-Inch (25.4 mm) Spaces <sup>①</sup>  
10 per Shelf Carton



**Three-Pole 240 Vac**  
Common Trip Requires Six  
1-Inch (25.4 mm) Spaces <sup>②</sup>  
5 per Shelf Carton

Ampere Rating	10 kAIC		Wire Size Range Cu/Al 60 °C or 75 °C	22 kAIC	
	Catalog Number	Catalog Number		Catalog Number	Catalog Number
125	BJ2125	BJH2125	#2–300 kcmil	BJ3125	BJH3125
150	BJ2150	BJH2150	#2–300 kcmil	BJ3150	BJH3150
175	BJ2175	BJH2175	#2–300 kcmil	BJ3175	BJH3175
200	BJ2200	BJH2200	#2–300 kcmil	BJ3200	BJH3200
225	BJ2225	BJH2225	#2–300 kcmil	BJ3225	BJH3225

### Plug-On Special Application Circuit Breakers—10 kAIC, 120 Vac, 120/240 Vac and 240 Vac

#### BRWH215

Water Heater Breaker



### Special Application Circuit Breakers, 1-Inch (25.4 mm) per Pole

#### Water Heater Breakers



**Two-Pole 120/240 Vac**  
Common Trip Requires Two  
1-Inch (25.4 mm) Spaces

With Isolated Line Terminals  
for Separately Metered  
Water Heaters

5 per Shelf Carton

10 kAIC

#### Switching Neutral Breakers

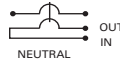

**Two-Pole 120 Vac**  
Common Trip Requires Two  
1-Inch (25.4 mm) Spaces

With Switching Neutral Pole  
for Gasoline Pump Applications

5 per Shelf Carton

10 kAIC

#### 240 V Breakers



**Two-Pole 240 Vac**  
Common Trip Requires Two  
1-Inch (25.4 mm) Spaces

Where Voltage to  
Ground is 240 Vac

5 per Shelf Carton

10 kAIC

#### Non-Automatic Molded Case Switches



**Two-Pole 240 Vac**  
Requires Two  
1-Inch (25.4 mm) Spaces

For Use as Disconnect Contains No  
Magnetic or Thermal Trip Properties

5 per Shelf Carton

5 kAIC

#### BRSN220

Switching Neutral Breaker



Ampere Rating	Catalog Number	Ampere Rating	Catalog Number	Wire Size Range Cu/Al 60 °C or 75 °C	Ampere Rating	Catalog Number	Ampere Rating	Catalog Number
15	BRWH215	15	BRSN215	#14–4	10	BR210H	—	—
20	BRWH220	20	BRSN220	#14–4	15	BR215H	—	—
30	BRWH230	25	BRSN225	#14–4	20	BR220H	—	—
—	—	30	BRSN230	#14–4	25	BR225H	—	—
—	—	—	—	#14–4	30	BR230H	—	—
—	—	—	—	#14–4	35	BR235H	—	—
—	—	—	—	#14–4	40	BR240H	—	—
—	—	—	—	#14–4	45	BR245H	—	—
—	—	—	—	#14–4	50	BR250H	50	BR250NA
—	—	—	—	#14–4	55	BR255H	—	—
—	—	—	—	#4–1/0	60	BR260H	60	BR260NA
—	—	—	—	#4–1/0	70	BR270H	—	—
—	—	—	—	#4–1/0	80	BR280H	—	—
—	—	—	—	#4–1/0	90	BR290H	—	—
—	—	—	—	#4–1/0	100	BR2100H	100	BR2100NA

#### Notes

① Breaker uses two 1-inch (25.4 mm) pole spaces on left side and two 1-inch (25.4 mm) pole spaces on right side of loadcenter.

② Breaker uses three 1-inch (25.4 mm) pole spaces on left side and three 1-inch (25.4 mm) pole spaces on right side of loadcenter.

If BJ or BJH breakers are used as a main or a back feed device, a hold-down kit is required. See **Page V1-T1-88**.



#### 1

#### Options and Accessories

THS1



BHLW2



BRQLW



MCBPL (Installed)

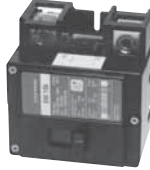

BHLW



BRLW2



#### Field Installation Kits and Parts

##### Description

Ordering Quantity <sup>①</sup> Catalog Number

##### New Products

Padlockable device for locking the handle of BR long body AF/GF breaker into the ON or OFF position		<b>BRLAFGFLOFF</b>
Padlockable device for locking the handle of BR short body BRCAF, BRAFGF, QBCAF, QBAFGF breakers into the ON or OFF position		<b>BRCAFLOFF</b>

##### Handle Ties <sup>②</sup>

Handle tie bar for physically joining the handles of two adjacent single-pole Type BR circuit breakers (metal cylinder pin type)	10	<b>BHT</b>
Handle tie bar for joining two independent outside poles of Types BQ and BQC Quadplex and outside poles of two Type BD duplex circuit breakers	10	<b>THOW</b>

Handle tie bar for joining two adjacent outside poles of Types BQ and BQC Quadplex and outside poles of two Type BD duplex circuit breakers	10	<b>THS1</b>
---	----	-------------

##### Handle Lockoffs <sup>③④</sup>

Padlockable device for locking the handle of single-, two- or three-pole Type BR Circuit Breakers and single-pole of a Type BD Duplex or one independent outside pole of a Type BQ or BQC Quadplex circuit breakers (escutcheon mounted) <sup>⑤</sup>	10	<b>BRLW</b>
---	----	-------------

Padlockable device for locking the handle of a single-pole Type BR circuit breaker (handle mounted) <sup>⑥</sup>	10	<b>BRLW1</b>
--	----	--------------

Padlockable device for locking the handle of a two- and three-pole Type BR circuit breaker (handle mounted) <sup>⑥</sup>	10	<b>BRLW2</b>
--	----	--------------

Padlockable device for locking the handle of a single-pole Type BD Duplex, BQ or BQC Quadplex breaker (handle mounted) <sup>⑥</sup>	10	<b>BRDL1</b>
---	----	--------------

Padlockable device for locking the handle of the two center poles and the two outer poles of a two-pole Types BQ and BQC quadplex circuit breakers (escutcheon mounted) <sup>⑤</sup>	10	<b>BRQLW</b>
--	----	--------------

Padlockable device for locking the handle of main circuit breaker Types CC and CHH into the ON or OFF position (screw mounted) <sup>⑦</sup>	1	<b>CCPL</b>
---	---	-------------

Padlockable device for locking the handle of main breaker Types BW and CSR into the ON or OFF position (escutcheon mounted) <sup>⑤</sup>	1	<b>MCBPL</b>
--	---	--------------

Device used to secure handle in ON or OFF position for single-, two- or three-pole Type BR circuit breakers and single-pole of Type BD duplex and one independent outside pole of Type BQ or BQC Quadplex circuit breakers (escutcheon mounted) <sup>⑤</sup>	10	<b>BHLW</b>
--	----	-------------

Device used to secure handle in ON or OFF position for single-pole Type BR circuit breakers (handle mounted) <sup>⑥</sup>	10	<b>BHLW1</b>
---	----	--------------

Device used to secure handle in ON or OFF position for two- and three-pole Type BR circuit breakers (handle mounted) <sup>⑥</sup>	10	<b>BHLW2</b>
---	----	--------------

Device used to secure handle in ON or OFF position for single-pole Type GFTCB ground fault circuit breakers (handle mounted) <sup>⑥</sup>	10	<b>BHGW</b>
---	----	-------------

Device used to secure handle in ON or OFF position for one independent outside pole of Types BQ and BQC Quadplex or single-pole Type BD duplex circuit breakers (handle mounted) <sup>⑥</sup>	10	<b>HLW1</b>
---	----	-------------

##### Notes

- ① Must be purchased in multiples of ordering quantities indicated.
- ② Handle ties: typically used to join two similar independent single-pole breakers to form a two-pole noncommon trip breaker.
- ③ Handle lockoffs: devices that use a padlock to lock the circuit breaker's handle in the ON or OFF position.
- ④ See table on **Page V1-T1-89** for handle position changeability chart.
- ⑤ Escutcheon mounted: device mounted semipermanently to the face of the circuit breaker and secured by the loadcenter deadfront.
- ⑥ Handle mounted: device mounted directly to the handle by the use of a set screw.
- ⑦ Screw mounted: device permanently mounted to the face of the circuit breaker by the use of a non-removable screw.
- ⑧ Hold-down kits: devices used to secure the circuit breaker to the loadcenter for back-feed main application. See NEC Article 408.36(D). Add "B" suffix to two-pole breaker for tapped hole for hold-down kit (ex. BR230B) for BR breakers below 60 A.

BRHQ125



BRHDK125



BRML



### Field Installation Kits and Parts, continued

Description	Ordering Quantity <sup>①</sup>	Catalog Number
<b>Hold-Down Kits <sup>②</sup></b>		
Hold-down retainer kit for three-pole Type BR circuit breakers in S3100 and 3100R loadcenters only	1	<b>BRHDB</b>
Hold-down screw kit for two- and three-pole Type BR circuit breakers in single-phase MLO loadcenters through 100–125 A	1	<b>BRHQ125</b>
Hold-down screw kit for two- and three-pole Type BR circuit breakers in MLO loadcenters 150–225 A	1	<b>BRHDK125</b>
Hold-down screw kit for two-pole Types BJ and BJH circuit breakers in MLO loadcenters 125–225 A	1	<b>BJHDS</b>
Hold-down screw kit for three-pole Types BJ and BJH circuit breakers in MLO loadcenters 125–225 A	1	<b>BJHDS3P</b>
<b>Main Breaker Lug Kits</b>		
Types CC and CHH main breaker lug kit (2) 300 kcmil	1	<b>CCL300</b>
Types BW/CSR main breaker lug kit (2) 300 kcmil	1	<b>MCBL300</b>
<b>Mechanical Interlocks</b>		
Types BR for two-, three- and four-pole breakers	10	<b>BRML</b>
<b>Padlock Brackets</b>		
BR padlock mounting bracket	10	<b>BRPLOFF</b>
BR three-pole lock-off bracket	10	<b>BRPLOFF3P</b>
BJ two-pole lock-off bracket	10	<b>BJL2P</b>
BJ three-pole lock-off bracket	10	<b>BJL3P</b>

### Shunt Trips, Auxiliary and Alarm Contacts

Description	Catalog Number <sup>②</sup> Suffix Adder
<b>Shunt Trip for Types BW/CSR</b>	
12 Volts	<b>SR12</b>
24 Volts	<b>SR24</b>
120 Volts	<b>SR01</b>
<b>Shunt Trip for Types BR</b>	
120 Volts	<b>ST</b>
<b>Auxiliary Contact for Types BW/CSR</b>	
1NO and 1NC	<b>AL1</b>
2NO and 2NC	<b>AL2</b>
<b>Alarm Contacts for Types BW/CSR</b>	
Types BW/CSR	<b>CR1</b>
<b>Alarm Contacts for Type GFTCB (Single-Pole)</b>	
Alarm contact for GFTCB (single-pole)	<b>W1</b>
1NO and 1NC	<b>W2</b>

### Handle Position Changeability Chart

To Change Handle Position from ON to OFF, or OFF to ON You Must...

Handle Lockoff and Lockdog Types	Remove Padlock	Remove Device	Remove Loadcenter Deadfront
Lockoff escutcheon mounted	Remove	—	—
Lockoff handle mounted	Remove	Remove	—
Lockoff screw mounted	Remove	—	—
Lockdog escutcheon mounted	N/A	Remove	Remove
Lockdog handle mounted	N/A	Remove	—

#### Notes

- <sup>①</sup> Must be purchased in multiples of ordering quantities indicated.
- <sup>②</sup> Add suffix indicated to end of breaker catalog number.

# 1.2

## Loadcenters and Circuit Breakers

Type BR Loadcenters and Circuit Breakers

### 1 Wiring Diagrams

Single-Pole 120 V Load Application Sourced by 120/240 Vac

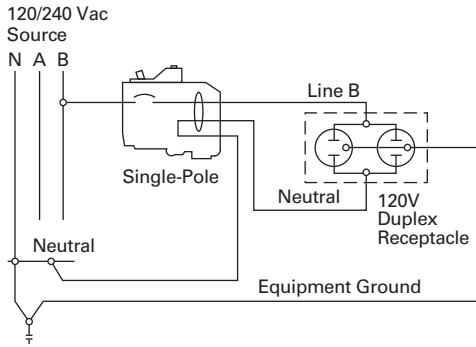

Two-Pole Shared Neutral with Duplex Receptacle Application

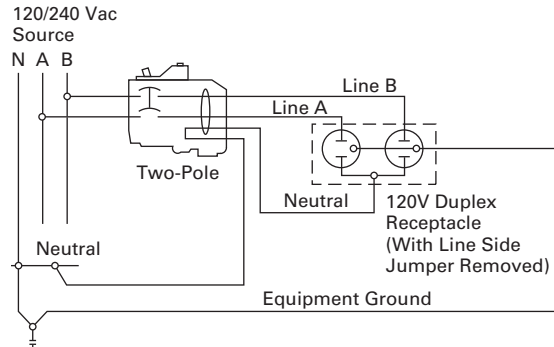

Two-Pole Shared Neutral with Multi-Duplex Receptacle Application

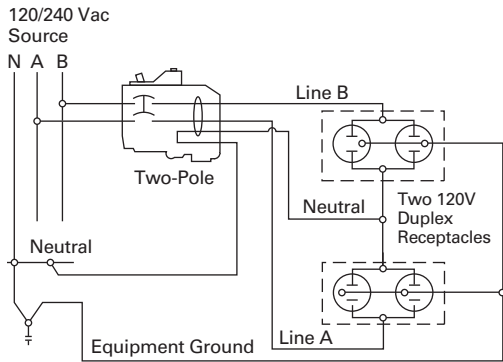

Single-Pole 120 V Load Application Sourced by 120/240 Vac

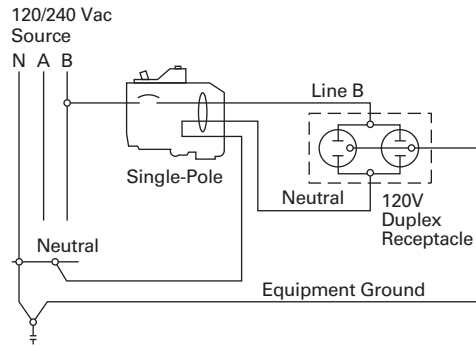

Two-Pole 240 V Load Application Sourced by 120/240 Vac

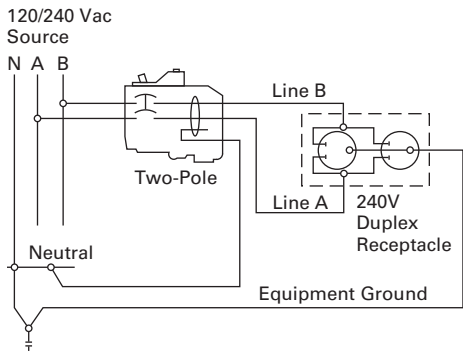

Single-Pole 120 V Duplex Receptacle Application

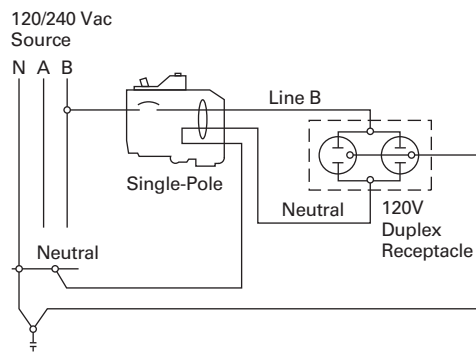

### Two-Pole 120 V Multi-Duplex Receptacle Application

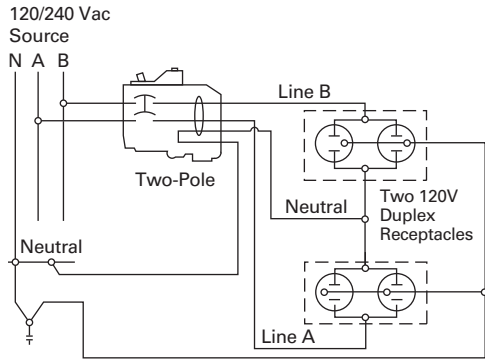

### Two-Pole 120 V Duplex Receptacle Application

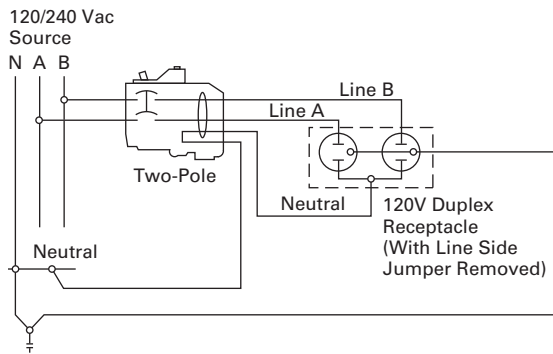

### Two-Pole 240 V Duplex Receptacle Application

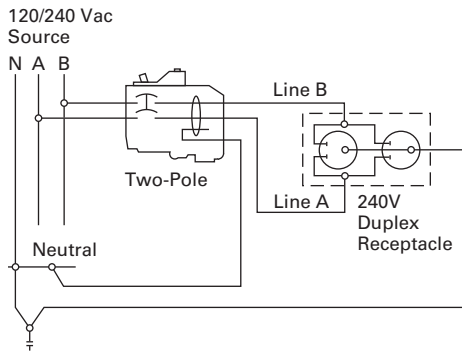



### Product Description

As a leader in the electrical distribution equipment business, Eaton has a unique product offering for equipment manufacturers, panel builders and virtually any OEM that has a need for power distribution within their equipment. The OEM interior offering consists of a wide variety of power distribution options utilizing components from Eaton's CH and BR loadcenter product lines. With high-volume, standardized products, OEMs can expect to receive high-quality products covering configurations meeting virtually any power distribution need.

Coupled with Eaton's expertise in circuit breaker design and manufacturing, OEM interiors provide solid power distribution and circuit protection in a compact, easy-to-install package. Interiors are offered from 2 to 42 circuits and from 70 to 225 A.

### Quality

Built in ISO 9002 certified manufacturing facilities, customers can be assured of the process quality in place for the manufacture of these products. Utilizing the latest in computer-controlled plating, painting, molding, stamping and welding processes, Eaton's customers have come to expect consistent high-quality from shipment to shipment.

### Two Products Offer Design Flexibility

As a manufacturer of two lines of loadcenters, Eaton is in a unique position to offer the broadest range of interiors in the market. Each line has its own unique characteristics that appeal to various segments of the market. OEM interiors are UL recognized components and are listed in either of the following UL files: E8741 or E52977.

### Contents

#### Description

	<i>Page</i>
Standards and Certifications . . . . .	<b>V1-T1-93</b>
Product Selection . . . . .	<b>V1-T1-93</b>

The CH interiors feature 100% copper bus and use the CH 3/4-inch (19.1 mm) wide circuit breaker, which minimizes panel space. Recognized by contractors for its sturdy design, the CH interior will appeal to those customers seeking an industrial quality bolted busbar and the space saving of 3/4-inch (19.1 mm) per bus stab. With a typical 12 circuit CH interior, this space savings amounts to an inch and a half savings over its 1-inch (25.4 mm) counterparts. The stab rating of the CH interiors is 140 A maximum meaning that the handle rating of breakers mounted across from one another may not exceed 140 A.

The BR interiors are manufactured of formed, plated aluminum or copper, and use Eaton's Type BR 1-inch (25.4 mm) wide circuit breaker. This design affords customers the most circuit flexibility as many of these interiors allow the installation of standard single- and two-pole breakers as well as duplex (two poles in a 1-inch (25.4 mm) space) or quadplex (four poles in a 2-inch (50.8 mm) space) breakers.

The stab rating of the BR interiors is 200 A maximum, meaning that the handle rating of the breakers that are mounted across from one another may not exceed 200 A.

The interiors are designed for either horizontal (single-row breaker mounting), or vertical (double-row breaker mounting). To comply with National Electrical Code (NEC) requirements, if mounted horizontally, when the breaker is ON, the handle should be in the UP position. When mounted vertically, the handle toggles from left to right, so this is not a concern.

### Standards and Certifications

#### Class CTL

National Electrical Code Paragraph 384.15 requires branch circuit panelboards to be provided with physical means to prevent the installation of more overcurrent devices than that number of which the enclosure was designed, rated and approved. Class CTL Duplex, Quadplex and twin breakers (identified by a catalog number prefix BD, BQ, BQC and CHT) are equipped with a UL listed rejection tab over the line terminal. All OEM interiors have appropriately notched stabs to accept these rejection tab Class CTL breakers.

Duplex, Quadplex and twin breakers manufactured without the rejection tab (identified by a catalog number prefix BR, BRD and CHT) are available for replacement purposes in older interiors.

#### Federal Specifications

All loadcenter enclosures meet Federal Specifications W-P-115b, Type 1, Class 2 requirements.

All 120/240 V breakers, both 1-inch (25.4 mm), 1/2-inch (12.7 mm) and 3/4-inch (19.1 mm) per pole meet the requirement of Federal Specifications W-C 375B/Gen Type 1.

#### Canadian Standards Association Listing

All single-pole and two-pole, 120/240 V breakers, both 1-inch (25.4 mm), 1/2-inch (12.7 mm) and 3/4-inch (19.1 mm) per pole, 225 A maximum, are listed as Certified by the Canadian Standards Association, Guide No. 69-11.19, Class 1432, File 18328.

#### Underwriters Laboratories Listing

All grounding bars manufactured comply with Underwriters Laboratories standards and are listed under Guide No. DHJR, File E31424, Volume W, Section 17.

All circuit breakers 10 A and larger comply with the Underwriters Laboratories "Standard for Branch Circuit and Service Circuit-Breakers" UL 489; Guide No. 60 10.2 File E31424, and "Requirements for Wire Connectors and Soldering Lugs," UL 486B, Guide No. 461 10-C File E7830.

All Eaton breakers where marked, are suitable for use with 60/75 °C rated wire, unless otherwise specified.

All devices comply with the 22 kAIC–10 kAIC UL series connected components File DKSY2 of the Recognized Components Index.

#### Lighting and Appliance Panelboards

Lighting and appliance branch circuit panelboards are defined in NEC (Article 408) as "One having more than 10 percent of its overcurrent devices rated 30 A or less for which neutral connections are provided." Article 408 also limits the number of overcurrent devices (branch circuit poles) to a maximum of 42 in any one cabinet. When the 42 poles are exceeded, two or more separate panels are required.

For more details and engineering drawings, see BR.31.02.S.E.



### Product Selection

#### Type CH Loadcenter Interior Assemblies—Copper Bus

Ampere Rating	Maximum Number 1-Inch (24.5 mm) Spaces		UL File Reference	Main Terminal Size (Per Phase)	Standard Package Quantity	Catalog Number
	Single Poles					
<b>Single-Phase Single Row Breaker Mounting—120/240 Vac, Three-Wire</b>						
70	2	2	E8741	(1) #8–#2 AWG Cu/Al	1	CH9MB270
125	2	2	E8741	(1) 2/0–#6 AWG Cu/Al	20	CH2L125INT
<b>Single-Phase Double Row Breaker Mounting—120/240 Vac, Three-Wire</b>						
125	4	4	E8741	(1) 2/0–#14 AWG Cu/Al	20	CH4L125INT
125	8	8	E8741	(1) 2/0–#6 AWG Cu/Al	20	CH8L125INT
125	12	12	E8741	(1) 2/0–#6 AWG Cu/Al	20	CH12L125INT
125	16	16	E8741	(1) 2/0–#6 AWG Cu/Al	20	CH16L125INT
200	12	12	E8741	(1) 300 kcmil–#4 AWG Cu/Al	20	CH12L200INT
200	16	16	E8741	(1) 300 kcmil–#4 AWG Cu/Al	10	CH16L200INT
225	24	24	E8741	(1) 300 kcmil–#4 AWG Cu/Al	10	CH24L225INT
225	32	32	E8741	(1) 300 kcmil–#4 AWG Cu/Al	10	CH32L225INT
225	42	42	E8741	(1) 300 kcmil–#4 AWG Cu/Al	10	CH42L225INT
<b>Three-Phase Double Row Breaker Mounting—208Y/120 Vac, Four-Wire—240 Vac, Three-Wire—120/240 Vac, Four-Wire Delta</b>						
125	12	12	E8741	(1) 2/0–#6 AWG Cu/Al	10	CH12L3125INT
125	18	18	E8741	(1) 2/0–#6 AWG Cu/Al	10	CH18L3125INT
125	24	24	E8741	(1) 2/0–#6 AWG Cu/Al	10	CH24L3125INT
225	24	24	E8741	(1) 300 kcmil–#4 AWG Cu/Al	10	CH24L3225INT
225	30	30	E8741	(1) 300 kcmil–#4 AWG Cu/Al	10	CH30L3225INT
225	42	42	E8741	(1) 300 kcmil–#4 AWG Cu/Al	10	CH42L3225INT

1

BR Loadcenter Interior Assembly



#### Type BR Loadcenter Interior Assemblies—Aluminum Bus

Ampere Rating	Maximum Number 1-Inch (24.5 mm) Spaces	Single Poles	UL File Reference	Main Terminal Size (Per Phase)	Standard Package Quantity	Catalog Number
<b>Single-Phase Single Row Breaker Mounting—120/240 Vac, Three-Wire</b>						
70	2	4	E8741	(1) #8-#2 AWG Cu/Al	20	24INT70B
125	2	4	E8741	(1) 1/0-#14 AWG Cu 2/0-12 AWG Al	20	24INT125B
125	6	12	E52977	(1) 2/0-#14 AWG Cu/Al	20	612INT125SRB
<b>Single-Phase Double Row Breaker Mounting—120/240 Vac, Three-Wire</b>						
125	4	8	E8741	(1) 2/0-#14 AWG Cu/Al	20	48INT125B
125	6	12	E8741	(1) 2/0-#14 AWG Cu/Al	20	612INT125B
125	8	16	E8741	(1) 2/0-#14 AWG Cu/Al	20	816INT125B
125	12	12	E52977	(1) 2/0-#14 AWG Cu/Al	20	1212INT125B
125	12	24	E52977	(1) 2/0-#14 AWG Cu/Al	20	1224INT125B
125	16	24	E52977	(1) 2/0-#14 AWG Cu/Al	20	1624INT125B
125	20	24	E52977	(1) 2/0-#14 AWG Cu/Al	10	2024INT125B
125	24	24	E52977	(1) 2/0-#14 AWG Cu/Al	10	2424INT125B
200	8	16	E52977	(1) 300 kcmil-#1 AWG Cu/Al	20	816INT200B
200	12	24	E52977	(1) 300 kcmil-#1 AWG Cu/Al	20	1224INT200B
200	30	40	E52977	(1) 300 kcmil-#1 AWG Cu/Al	10	3040INT200B
225	42	42	E52977	(1) 300 kcmil-#1 AWG Cu/Al	10	4242INT225B
<b>Three-Phase Double Row Breaker Mounting—208Y/120 Vac, Four-Wire—240 Vac, Three-Wire—120/240 Vac, Four-Wire Delta</b>						
125	12	24	E52977	(1) 2/0-#8 AWG Cu/Al	10	1224INT3125B
150	18	36	E52977	(1) 300 kcmil-#2 AWG Cu/Al	10	1836INT3150B
150	24	42	E52977	(1) 300 kcmil-#2 AWG Cu/Al	10	2442INT3150B
200	30	42	E52977	(1) 300 kcmil-#2 AWG Cu/Al	10	3042INT3200B
225	42	42	E52977	(1) 300 kcmil-#2 AWG Cu/Al	10	4242INT3225B

#### Type BR Loadcenter Interior Assemblies—Copper Bus

Ampere Rating	Maximum Number 1-Inch (24.5 mm) Spaces	Single Poles	UL File Reference	Main Terminal Size (Per Phase)	Standard Package Quantity	Catalog Number
<b>Single-Phase Double Row Breaker Mounting—120/240 Vac, Three-Wire</b>						
125	8	16	E5297	(1) 2/0-#14 AWG Cu/Al	20	816INT125BC
125	12	12	E5297	(1) 2/0-#14 AWG Cu/Al	20	1212INT125BC
200	12	24	E5297	(1) 300 kcmil-#1 AWG Cu/Al	20	1224INT200BC
<b>Three-Phase Double Row Breaker Mounting—208Y/120 Vac, Four-Wire—240 Vac, Three-Wire—120/240 Vac, Four-Wire Delta</b>						
125	12	24	E52977	(1) 2/0-#8 AWG Cu/Al	10	1224INT3125BC
200	12	24	E52977	(1) 300 kcmil-#2 AWG Cu/Al	10	1224INT3200BC

### Neutral Assemblies

Ampere Rating	UL File Rating	Main Incoming Terminal Wire Size Range 60 °C or 75 °C	Number of Terminals		Standard Package Quantity	Figure	Dimensions—Inches (mm)		Catalog Number
			#14–4 AWG Cu/Al	#6–1/0 AWG Cu #6–2/0 AWG Al			Overall Length A	Mounting B	
125	E52977	#6–1/0 AWG Cu #6–2/0 AWG Al	10	—	20	1	5.938 (150.83)	5.400 (137.16)	10NEU125B
125	E52977	#6–1/0 AWG Cu #6–2/0 AWG Al	17	—	20	1	8.388 (213.06)	7.850 (199.40)	17NEU125B
125	E52977	#6–1/0 AWG Cu #6–2/0 AWG Al	20	—	20	1	9.438 (239.73)	8.900 (226.06)	20NEU125B
225	E52977	#1–300 kcmil Cu/Al	24	1	20	2	10.913 (277.19)	10.300 (261.62)	24NEU225B
225	E52977	#1–300 kcmil Cu/Al	35	1	20	2	15.813 (401.65)	15.200 (386.08)	35NEU225B
125	—	—	4	2	1	3	2.266 (57.56)	0.594 (15.09)	BINA

**Figure 1**

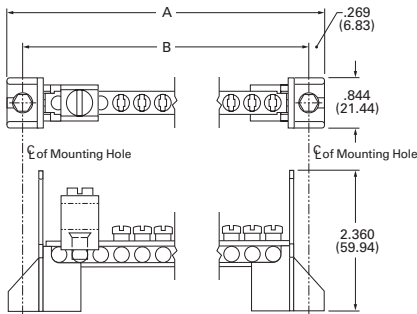

**Figure 2**

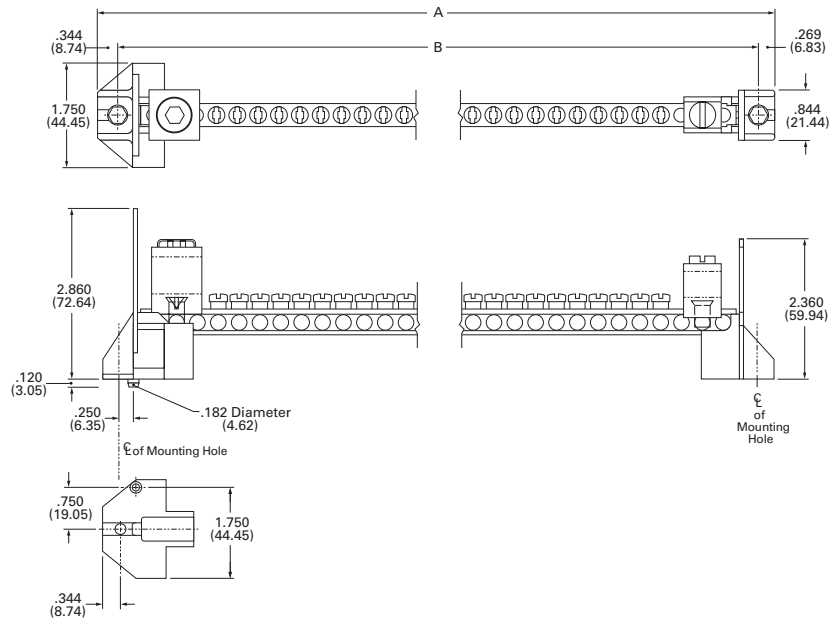

**Figure 3**

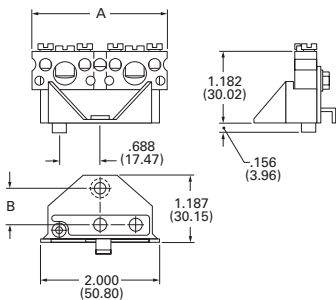



#### Add-on Lugs for Neutral Assemblies

Description	Wire Size Range Cu/Al 60 °C or 75 °C	Ordering Quantity <sup>①</sup>	Catalog Number
Neutral/ground lug	#2/0 maximum	1	NL20
Add-on neutral or ground lug	#3/0 maximum	1	NL30
	300 kcmil maximum	1	NL300

#### GBK14



#### BRGBK39512



#### Ground Bar Kits

Description (See Legend)	Length Inches (mm)	Ordering Quantity <sup>①</sup>	Catalog Number
●○○○○●	2.54 (64.5)	1	GBK5 <sup>②</sup>
●○○○○●■	3.59 (91.2)	1	GBK520 <sup>②</sup>
●○○○○●○○○○	4.29 (109.0)	1	GBK10 <sup>②</sup>
●○○○○●○○○○■	5.34 (135.6)	1	GBK1020 <sup>②</sup>
— — — — —	4.61 (117.1)	1	GBK13 <sup>②</sup>
●○○○○●○○○○○○○○	5.69 (144.5)	1	GBK14 <sup>②</sup>
●○○○○●○○○○○○○○■	6.74 (171.2)	1	GBK1420 <sup>②</sup>
●○○○○●○○○○○○○○○○○○○○	8.14 (206.8)	1	GBK21 <sup>②</sup>
●○○○○●○○○○○○○○○○○○○○■	9.19 (233.4)	1	GBK2120 <sup>②</sup>
⌵ — ⌵ — ⌵ — ⌵ — ⌵	5.78 (146.8)	1	BRGBK39512 <sup>③④</sup>

#### Ground Bar Legend

- (3) #14–10 Cu/Al or (1) #14–4 Cu/Al
- (1) #6–2/0 Cu/Al
- ⌵ (1) #14–1/0 Cu/Al or (3) #14–10 Cu/Al
- (1) #14–6 Cu/Al or (2) #14–12 Cu/Al
- Mounting Hole

#### Notes

- ① Must be purchased in multiples of ordering quantities indicated.
- ② Distance between mounting holes is 1.75 inches (44.5 mm).
- ③ For single- and three-phase 400 and 600 A applications.
- ④ Distance between mounting holes is 2.34 inches (59.5 mm).

### Enclosed Breakers



### Contents

#### Description

Product Selection .....	V1-T1-98
Dimensions .....	V1-T1-98

#### Page

V1-T1-98
V1-T1-98

### Product Overview

Eaton enclosed breakers offer all the advantages of circuit breakers packed in an enclosure for 240 Vac applications and include a wide range of accessories.

### Product Description

- 100–225 A, 240 Vac maximum
- NEMA 1 general purpose—surface or flush mounting
- NEMA 3R rainproof surface mounting

### Standards and Certifications

- UL 489
- CSA 22.2
- NEMA 250



## Product Selection

### Single-Phase and Three-Phase Circuit Breaker Enclosures—10/25 kAIC

ECC225R



#### Type ECC Circuit Breaker Enclosure—Order Type CC Circuit Breaker Separately

Main Ampere Rating	Unit Enclosure Type	Mounting Type	Circuit Breaker Type	Wire Size Range Cu/Al 60 °C or 75 °C	Catalog Number
<b>Single- and Three-Phase—240 Vac Maximum</b>					
100	Indoor	Surface	CCVH factory installed (25 kAIC)	#4–4/0	<b>ECCVH100S</b> ①②③
150	Indoor	Surface	CCVH factory installed (25 kAIC)	#4–4/0	<b>ECCVH150S</b> ①②③
200	Indoor	Surface	CCVH factory installed (25 kAIC)	#2/0–300 kcmil	<b>ECCVH200S</b> ①②③
100	Outdoor	—	CCVH factory installed (25 kAIC)	#4–4/0	<b>ECCVH100R</b> ①②④
150	Outdoor	—	CCVH factory installed (25 kAIC)	#4–4/0	<b>ECCVH150R</b> ①②④
200	Outdoor	—	CCVH factory installed (25 kAIC)	#2/0–300 kcmil	<b>ECCVH200R</b> ①②④
225	Indoor	Flush	CC/CCV/CCH	⑥	<b>ECC225F</b> ②③⑤
225	Indoor	Surface	CC/CCV/CCH	⑥	<b>ECC225S</b> ②③⑤
225	Outdoor	—	CC/CCV/CCH	⑥	<b>ECC225R</b> ②③④⑤

CCV2200



#### Circuit Breaker 240 Vac for Use in Type ECC Enclosures

Ampere Rating	Wire Size Range Cu/Al 60 °C or 75 °C for Line Terminals	Type CCV and CC 10 kAIC Catalog Number	Type CCVH/CCH 25 kAIC Catalog Number
<b>Two-Pole</b>			
60	#2–300 kcmil	<b>CCV2060</b>	<b>CCVH2060</b>
70		<b>CCV2070</b>	<b>CCVH2070</b>
80		<b>CCV2080</b>	<b>CCVH2080</b>
90		<b>CCV2090</b>	<b>CCVH2090</b>
100		<b>CCV2100</b>	<b>CCVH2100</b>
125		<b>CCV2125</b>	<b>CCVH2125</b>
150		<b>CCV2150</b>	<b>CCVH2150</b>
175		<b>CCV2175</b>	<b>CCVH2175</b>
200		<b>CCV2200</b>	<b>CCVH2200</b>
225		<b>CCV2225</b>	<b>CCVH2225</b>
<b>Three-Pole</b>			
100	#2–300 kcmil	<b>CC3100</b>	<b>CCH3100</b>
125		<b>CC3125</b>	<b>CCH3125</b>
150		<b>CC3150</b>	<b>CCH3150</b>
175		<b>CC3175</b>	<b>CCH3175</b>
200		<b>CC3200</b>	<b>CCH3200</b>
225		<b>CC3225</b>	<b>CCH3225</b>

#### Shunt Trips and Auxiliary Contacts

Description Type	Volts	Catalog Number Suffix Adder ⑦
<b>Shunt Trip</b>		
CC	12 DC	<b>SR12</b>
CC	24 DC	<b>SR24</b>
CC	120 AC	<b>SR01</b>
CC	208 AC	<b>SR08</b>
CC	240 AC	<b>SR02</b>
CCV	48–127 AC/48–60 DC	<b>SR01</b>
CCV	9–24 AC/12–24 DC	<b>SR02</b>
CCV	208–380 AC/100–127 DC	<b>SR04</b>
<b>Auxiliary Contact</b>		
CC 1N0 and 1N1	—	<b>AL1</b>

#### Dimensions

Approximate Dimensions in Inches (mm)

#### ECC Unit Enclosures—NEMA Type 1 Indoor

Height	Width	Depth
23.25 (590.6)	8.88 (225.4)	4.50 (114.3)

#### ECC Unit Enclosures—NEMA Type 3R Outdoor

Height	Width	Depth
23.68 (601.7)	9.31 (236.5)	5.44 (138.1)

#### Notes

- ① Factory installed CCVH breaker.
- ② Approved for service entrance.
- ③ One ground lug accepting (1) #14–#2 is factory installed. Also, there are pre-drilled holes to accept a GBK5 ground bar.
- ④ Rainproof panels are furnished with hub closures plates. For rainproof hubs, refer to **Page V1-T1-71**.
- ⑤ Order circuit breaker separately.
- ⑥ Wire size is determined by the circuit breaker installed in enclosure.
- ⑦ Add suffix indicated to end of breaker catalog number.

### Classified Breakers



### Contents

<i>Description</i>	<i>Page</i>
Product Selection . . . . .	V1-T1-100
Accessories . . . . .	V1-T1-102
Technical Data. . . . .	V1-T1-102
Wiring Diagrams. . . . .	V1-T1-103

### Product Description

Eaton UL classified Replacement Circuit Breakers are available in both 3/4-inch Type CHQ and 1-inch Type CL, single- and two-pole configurations. These breakers are classified as direct replacements by Underwriters Laboratories. In addition to a UL listing, they also come with a 15-year warranty.

### Specified vs. UL Classified

Specified breakers are listed by the manufacturer of the panelboard for use in a particular panel. This doesn't mean that the panelboard manufacturer produced the specified breaker; it merely means that the panelboard manufacturer has tested the breaker in the panel. In fact, through the years, Eaton has manufactured thousands of breakers for other panelboard manufacturers.

UL classified breakers are produced by one manufacturer for use in place of the breakers specified on the panelboard. Like specified breakers, UL classified breakers have been tested in the panels for which they are approved.

### Testing

Classified breakers are tested extensively in numerous General Electric®, Siemens®, Murray®, Thomas & Betts®, Square D®, and Crouse-Hinds® panels. The tests are conducted with witnesses from Underwriters Laboratories Inc. and involve short-circuit, temperature, and insertion/withdrawal applications. This level of testing ensures that the breakers meet identified standards and have been found suitable by UL for the specified purpose.

### Understanding Classified Breaker Terminology

#### Definitions

**Specified circuit breaker**—each manufacturer lists the brands of circuit breakers that can be used in their panelboards. Often, manufacturers will not list competitors as specified, even though they are suitable replacements.

**Classified circuit breaker**—a breaker that is considered suitable, by a qualified third-party organization, for use in another manufacturer's panelboard.

**Listed breaker**—the listing of a circuit breaker is by an independent third party. Eaton classified breakers are listed by UL.

**Labeled breaker**—a breaker with a label affixed by an independent third party.

#### 1

### Product Selection

#### Type CHQ Replacement Breakers for Square D Type QO Loadcenters

10 kAIC, 120 and 120/240 Vac

CHQ120 CHQ230



#### Type CHQ Classified Breakers 3/4-Inch (19.1 mm) per Pole 120 or 120/240 Vac, 10 kAIC

Ampere Rating	Wire Size Range Cu/Al 60 °C or 75 °C	Catalog Number	
		Single-Pole 120/240 Vac Requires One 3/4-Inch (19.1 mm) Space 10 per Shelf Carton	Two-Pole 120/240 Vac Common Trip Requires Two 3/4-Inch (19.1 mm) Spaces 5 per Shelf Carton
15	(1) #14–8	CHQ115	CHQ215
20	(2) #14–10	CHQ120	CHQ220
25		CHQ125	CHQ225
30		CHQ130	CHQ230
35		CHQ135	CHQ235
40		CHQ140	CHQ240
45		CHQ145	CHQ245
50		CHQ150	CHQ250
60		—	CHQ260

#### Type CHQ Surge Arrester

Catalog Number



CHQSA

### Type CL Replacement Breakers for Square D HOMELINE, General Electric, Crouse-Hinds, Thomas & Betts, Murray and ITE®/Siemens Loadcenters

CL\_

#### Type CL Breakers, 1-Inch (25.4 mm) per Pole, 10 kAIC



Ampere Rating	Wire Size Range Cu/Al 60 °C or 75 °C	 Single-Pole 120/240 V Requires One 1-Inch (25.4 mm) Space 10 per Shelf Carton Catalog Number		 Two-Pole 120/240 V Common Trip Requires Two 1-Inch (25.4 mm) Spaces 5 per Shelf Carton Catalog Number	
15	#14-4	CL115	CL215		
20	#14-4	CL120	CL220		
25	#14-4	CL125	CL225		
30	#14-4	CL130	CL230		
35	#14-4	CL135	CL235		
40	#14-4	CL140	CL240		
45	#14-4	CL145	CL245		
50	#14-4	CL150	CL250		

CL\_AF

#### Type CL Classified Arc and Ground Fault Breakers (5 Milliampere), 1-Inch (25.4 mm) per Pole, 10 kAIC





Ampere Rating	Wire Size Range Cu/Al 60 °C or 75 °C	 Single-Pole 120/240 V Requires One 1-Inch (25.4 mm) Space 1 per Shelf Carton Catalog Number	
<b>Arc Fault Breakers</b>			
15	#14-4	CL115AF	
15	#14-4	CL115CAF	
20	#14-4	CL120AF	
20	#14-4	CL120CAF	
<b>Ground Fault Breakers</b>			
15	#14-4	CL115GFT	
20	#14-4	CL120GFT	
30	#14-4	CL130GFT	

CLR\_

#### Type CL Classified Latching Remote Control Smart Breakers™, 1-Inch (25.4 mm) per Pole, 10 kAIC



Ampere Rating	Wire Size Range Cu/Al 60 °C or 75 °C	 Single-Pole 120 V Requires One 1-Inch (25.4 mm) Space 10 per Shelf Carton Catalog Number		 Two-Pole 120/240 V Common Trip Requires Two 1-Inch (25.4 mm) Spaces 5 per Shelf Carton Catalog Number	
15	(2) #14-10	CLRP115	CLRP215		
20	(2) #14-10	CLRP120	CLRP220		
25	(1) #8-6	CLRP125	CLRP225		
30	(1) #8-6	CLRP130	CLRP230		

**Accessories****CHQ Breaker Accessories**

Description	Catalog Number
Breaker handle lock	CHLO

**Technical Data****Arc Fault Application Notes**

An arc fault circuit interrupter is a device intended to provide protection from the effects of arc faults by recognizing characteristics unique to arcing and by functioning to de-energize the circuit when the arc fault is detected. As of January 1, 2002, the National Electrical Code (NEC) requires all branch circuits that supply 125 V, single-phase, 15 and 20 A receptacle outlets installed in dwelling unit bedrooms shall be protected by an arc fault circuit interrupter(s). This includes ceiling lighting (recessed, ceiling fans, etc.) as well as smoke detectors and all other bedroom outlets. The 2005 NEC introduced the application of the Combination Type AFCI for bedroom circuits required as of January 1, 2008. The 2008 NEC expands this application to other living areas.

**Ground Fault Application Notes**

Single-pole GFTCBs are designed for use in two-wire, 120 Vac circuits. Drawing on **Page V1-T1-103** shows a typical wiring configuration.

Two-pole GFTCBs are designed for use in three-wire, 120/240 Vac circuits, 120 Vac multiwire circuits employing common, neutral and two-wire, 240 Vac circuits obtained from a 120/240 Vac source.

Drawings on **Page V1-T1-103** illustrate typical wiring configurations for 120/240 Vac multiwire circuits.

Drawing on **Page V1-T1-103** depicts a 240 Vac, two-wire circuit. Note the “panel neutral” conductor connects to the neutral bar, even though the neutral is not included in the load circuit. This connection is necessary to supply a 120 Vac power source to the ground fault sensing circuit.

The figures are shown with a 120/240 Vac, single-phase, three-wire power source, but are also applicable to a 120/208 Vac, three-phase, four-wire power supply. For all figures, the electrical operation of the GFTCB is not affected by the equipment ground.

**Wiring Diagrams**

**Single-Pole 120 V Load Application Sourced by 120/240 Vac**

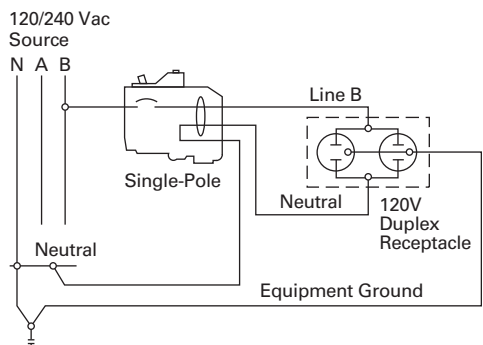

**Two-Pole 240 V Load Application Sourced by 120/240 Vac**

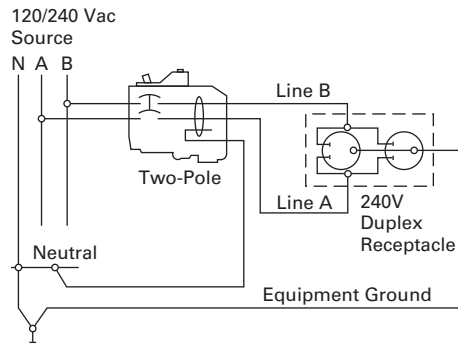

**Two-Pole Shared Neutral with Multi-Duplex Receptacle Application**

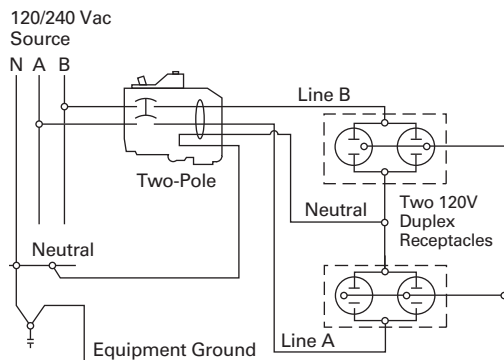

**Two-Pole Shared Neutral with Duplex Receptacle Application**

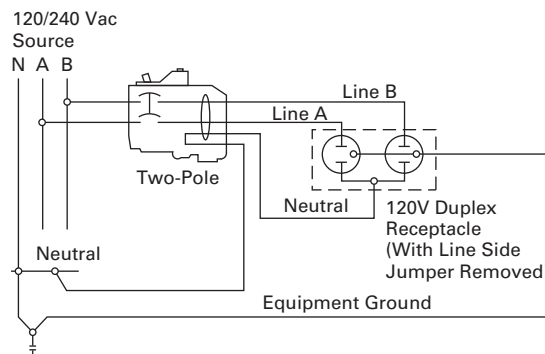

**Single-Pole 120 V Duplex Receptacle Application**

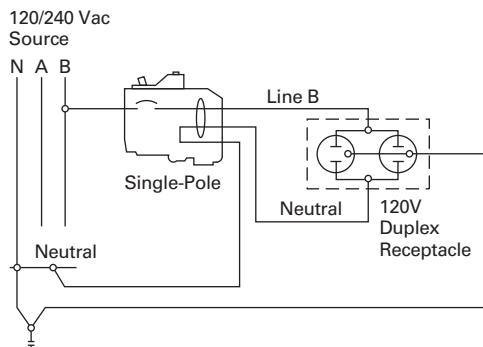

**Two-Pole 120 V Duplex Receptacle Application**

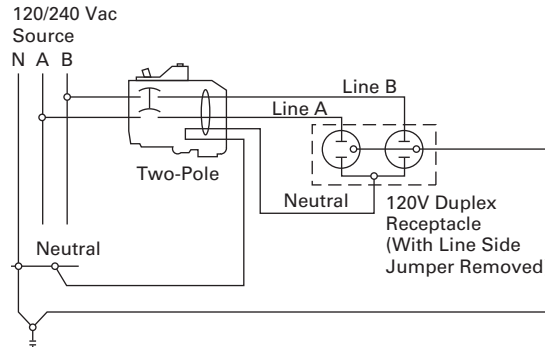

**Two-Pole 120 V Multi-Duplex Receptacle Application**

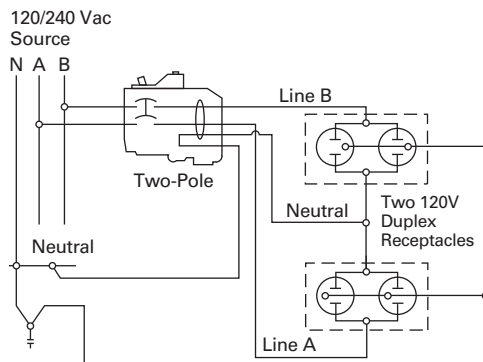

**Two-Pole 240 V Duplex Receptacle Application**

