

**Caretaker**  
LED Area Luminaire

**Lumark**



**EATON**

*Powering Business Worldwide*

# Security Made Easy by Design

## Superior Illumination Performance

The Caretaker™ LED Area Luminaire delivers unmatched performance in a rugged design for low-cost, low maintenance security light applications where a highly visible light source is desired. A NEMA photocontrol provides automatic dusk-to-dawn operation and high output LEDs deliver over 5,200 lumens. At only 50W (replacing up to 175W HID), the Caretaker luminaire provides up to 85 percent in energy and maintenance savings compared to traditional HID products.

## Low Maintenance and Long Life

Key factors when addressing energy consumption and total cost of ownership include longevity, light output and low maintenance. With lumen maintenance greater than 84 percent at 36,000 hours, the Caretaker luminaire is virtually maintenance-free for over 15 years.

## Ease of Installation

Installation is made simple with a versatile, universal wall and wood pole mounting bracket. A specially designed support tab on the universal bracket enables the Caretaker luminaire to be positioned and secured in a single step. A hinged power tray door and a single, captive screw allows for safe and easy access when making electrical connections.

## Built to Last

Tough weather conditions are no match for the heavy-duty die-cast, aluminum housing. The LED module compartment is rated for IP66, wet location operation in -40°C to 40°C applications ensuring continued performance in extreme weather. A 6kV integral surge protection device protects drivers and LED components.

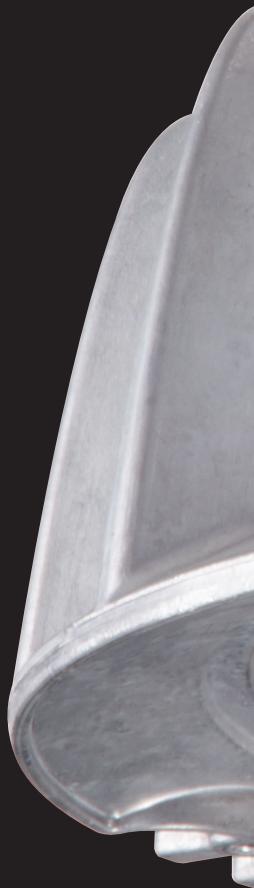

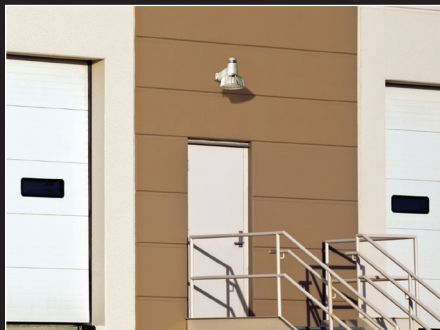

Energy efficiency, high output, easy installation and low maintenance make the Caretaker LED Area Luminaire the best choice for security lighting applications such as perimeter area lighting, loading platforms, residential streetlighting, parking areas, boat docks and access drives.

# Design Performance Features

## Construction

- Heavy-duty, die-cast aluminum door and housing
- Hinged, removable power tray door
- Single-point access with stainless steel captive screw
- UL/cUL wet location listed
- 3G vibration rated
- Universal wall and wood pole mount bracket
- Two-bolt slipfitter for pipe mounting (1-5/8" to 2-3/8" O.D.)

## Electrical

- Ambient temperature rating of -40°C to 40°C (-40°F to 104°F)
- 120V 50/60 Hz
- 6kV surge protection. Class C1 outdoor low compliant per IEEE C62.41
- NEMA twistlock photocontrol for dusk-to-dawn operation
- LED driver mounts to removable power tray door for optimal heat sink and maintenance
- LEDs maintain greater than 84% of initial light output after 36,000 hours (per IESNA TM-21 standards)

## Optical

- IP66 rated LED enclosure
- Injection-molded optics designed for widespread coverage and excellent uniformity
- Thermally optimized 5000K CCT LEDs
- Type V symmetric distribution
- Full cutoff design for Dark Sky compliance

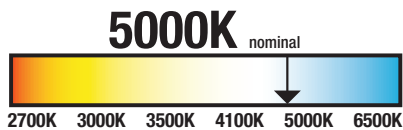

## Optical Refractors

- Small acrylic refractor
- Standard ANSI/NEMA acrylic refractor assembly

## Finish

- Standard raw aluminum finish

## Warranty

- Five-year warranty



## Single-Point Entry and Hinged Door

A single, captive screw and hinged, removable power tray door provides safe and fast access when making electrical connections.

## Mounting Options



### Wall Mount

Wall mounting is simplified with the universal bracket, which can be positioned for either wall or wood pole mounting.

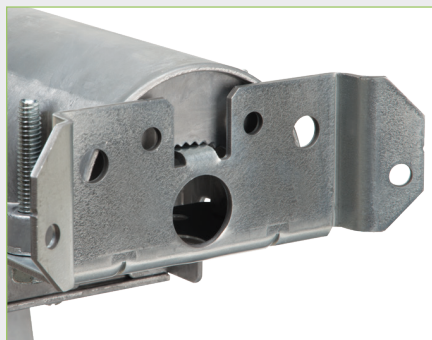

### Wood Pole Mount

Simply rotate the universal bracket with tabs against pole for wood pole mounting.



### Pipe Arm Mount

Retrofit to existing pipe bracket arms with integral two-bolt slipfitter standard for mounting on 1-1/4" to 2" standard pipe (1-5/8" to 2-3/8" O.D.).



### Optional Refractors

Wayfinding principles are utilized in the design of refractors for the Caretaker luminaire to create a sense of security by redirecting light into a desired direction and pattern for increased visibility.

#### < Small Acrylic Refractor

Utilize the small acrylic refractor for enhanced security installations which require increased fixture visibility.

#### ANSI/NEMA Acrylic Refractor >

Compatible with ANSI/NEMA open-bottom refractor to match traditional fixtures.



# Light Distribution and Energy Savings

## Bright, Secure and Uniform Illumination

The Caretaker LED Area Luminaire is designed to provide maximum security in any application. Combining bright, high-efficiency LEDs with precision-molded optics, the Caretaker luminaire delivers a wide, uniform distribution with excellent vertical illumination for maximum light coverage. With effective thermal management, the LED light engine is optimized for energy-efficient, long-term performance.

## 50W Caretaker LED and 100W High Pressure Sodium Comparison

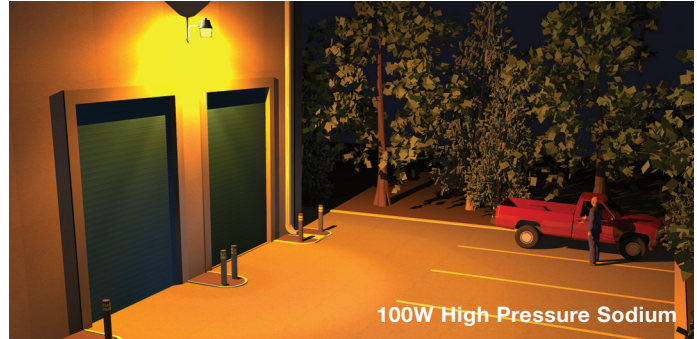

**NOTE:** Typical mounting heights are 10'-30'. Simulation rendering using AGi32 software.

## Lighting Design Guide

The Caretaker LED Area Luminaire is designed for use in a wide variety of applications, including industrial, retail, residential, recreation areas, boat docks, roadways, pathways or anywhere security area lighting is needed. Precision-molded, acrylic optics produce uniform, wide distributions, which allow for mounting heights from as low as 10' above a doorway to as high as a 30' pole.

### Mounting Height/Lamp Comparison

Mounting Height	Light Source	X	Y	Z
15'	50W LED Caretaker Area Luminaire	48'	41'	30'
	70W High Pressure Sodium	38'	33'	26'
	175W Mercury Vapor	47'	37'	25'
	100W Metal Halide	38'	33'	27'
20'	50W LED Caretaker Area Luminaire	56'	45'	32'
	70W High Pressure Sodium	45'	38'	27'
	100W Metal Halide	44'	39'	29'
	100W High Pressure Sodium	52'	43'	33'
25'	50W LED Caretaker Area Luminaire	62'	49'	29'
	100W Metal Halide	51'	44'	27'
	100W High Pressure Sodium	57'	47'	32'
	175W Metal Halide	61'	44'	28'

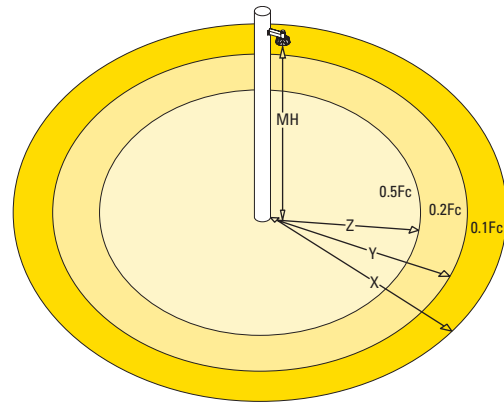

## Reduced Energy Consumption

Operating and maintenance costs of a lighting system are dramatically impacted by the specified lamp source and electrical system. Total system input watts and fixture operating life should be the driving considerations when addressing energy consumption and total cost of ownership. Energy savings increase when energy consumption is reduced and maintenance intervals are extended.

### Annualized Energy Savings/Cost Comparison

Wattage / Lamp Type	Hours Per Day / Year	Life (Hours)	System Wattage	Cost / Year at \$0.10 kWh*	Annual Maintenance Cost*	Total Annual Cost / Fixture	Annual Savings per Fixture	Percent of Savings
50W LED Caretaker Area Luminaire	9 / 3,285	72,000	50W	\$16.43	--	\$16.43	\$71.23	81%
70W High Pressure Sodium		16,000	86W	\$28.25	\$59.40	\$87.65		
50W LED Caretaker Area Luminaire	9 / 3,285	72,000	50W	\$16.43	--	\$16.43	\$110.32	87%
175W Mercury Vapor		16,000	205W	\$67.34	\$59.40	\$126.74		
50W LED Caretaker Area Luminaire	9 / 3,285	72,000	50W	\$16.43	--	\$16.43	\$110.82	87%
100W Metal Halide		12,000	128W	\$42.05	\$85.20	\$127.25		
50W LED Caretaker Area Luminaire	9 / 3,285	72,000	50W	\$16.43	--	\$16.43	\$89.62	85%
100W High Pressure Sodium		16,000	130W	\$42.71	\$63.34	\$106.04		
50W LED Caretaker Area Luminaire	9 / 3,285	72,000	50W	\$16.43	--	\$16.43	\$197.59	92%
175W Metal Halide		7,000	210W	\$68.99	\$145.03	\$214.01		

\* Nominal lumens prior to optical and configuration losses based on 5000K CCT at 40°C. Caretaker 5,212 lumens. Hours of life based on 70% lumen maintenance. Cost = (Watts x 9 Hours Per Day x 365 Days Per Year) / 1000 = Daily Kilowatt hour (kWh). kWh x .10 cents/kWh = Cost/year at .10 kWh. Re-lamp based on selected technology. Maintenance cost includes lamp and labor.

# Ordering Information

Stock Sample Number: CTKRV1A

Product Family	Wattage	Driver	LED Kelvin (CCT)	Photocontrol	Mounting	Accessories (Order Separately)
CTKRV1A=Caretaker	50W	120V	5000K	NEMA Twistlock	Wall/Pole Mount Bracket and Integral Slipfitter	SR-Caretaker=Small Acrylic Refractor RMARROA5=ANSI/NEMA Acrylic Refractor Assembly

## Dimensions

### Full Cutoff

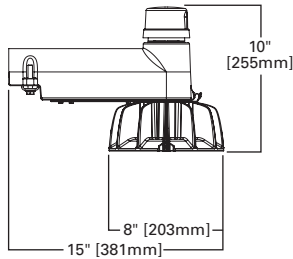

### Small Acrylic Refractor

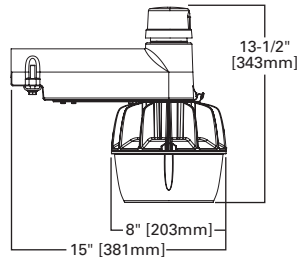

### ANSI/NEMA Acrylic Refractor Assembly

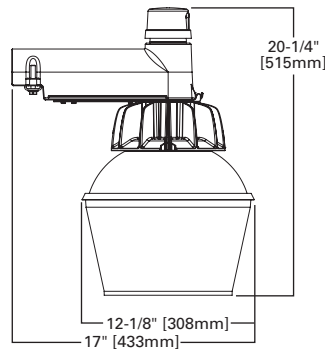

### Wall/Pole Mounting Bracket (Included)

#### Wall Mount

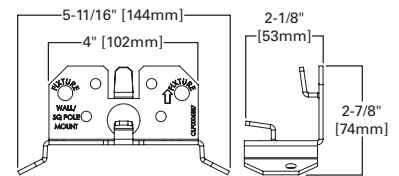

#### Pole Mount

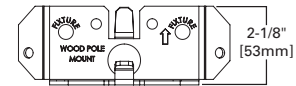

## Power and Lumens

CCT (Color Temperature)	5000K	
Power (Watts)	50W	
Input Current @ 120V (A)	0.41	
Optics		
Type V	Lumens	5,212
	BUG Rating	3-0-1

## Lumen Multiplier

Ambient Temperature	Lumen Multiplier
10°C	1.04
15°C	1.03
25°C	1.00
40°C	0.96

## Lumen Maintenance

Ambient Temperature	TM-21 Lumen Maintenance (36,000 Hours)	Theoretical L70 (Hours)
25°C	> 86%	> 87,000
40°C	> 84%	> 72,000

## Additional Information

Compliances	Technical Data (Electronic LED Driver)	EPA Effective Projected Area (Square Feet)	Shipping Data (Approximate Net Weight)
UL and cUL Wet Location Listed UL1598 Listed IP66 Rated LED Array 3G Vibration Rated DesignLights Consortium® Qualified Lighting Fact® Registered LM79/LM80 Compliant RoHS Compliant	> 0.9 Power Factor < 20% Total Harmonic Distortion 120V 50/60Hz -40°C Minimum Ambient Temperature Rating +40°C Maximum Ambient Temperature Rating	0.67	8.0 lbs. (3.6 kgs.)



NOTE: Specifications and dimensions subject to change without notice.

### **Lighting Product Lines**

Halo  
Halo Commercial  
Portfolio  
Iris  
RSA  
Metalux  
Corelite  
Neo-Ray  
Fail-Safe  
MWS  
Ametrix  
Shaper  
io  
Lumark  
McGraw-Edison  
Invue  
Ephesus  
Lumière  
Streetworks  
AtLite  
Sure-Lites

### **Controls Product Lines**

Greengate  
iLumin  
Zero 88  
Fifth Light Technology  
iLight (International Only)

### **Connected Lighting Systems**

LumaWatt Pro  
WaveLinx  
Distributed Low-Voltage Power  
ConnectWorks



**Caretaker**  
LED Area Luminaire

**Lumark**



**EATON**

*Powering Business Worldwide*

# Security Made Easy by Design

## Superior Illumination Performance

The Caretaker™ LED Area Luminaire delivers unmatched performance in a rugged design for low-cost, low maintenance security light applications where a highly visible light source is desired. A NEMA photocontrol provides automatic dusk-to-dawn operation and high output LEDs deliver over 5,200 lumens. At only 50W (replacing up to 175W HID), the Caretaker luminaire provides up to 85 percent in energy and maintenance savings compared to traditional HID products.

## Low Maintenance and Long Life

Key factors when addressing energy consumption and total cost of ownership include longevity, light output and low maintenance. With lumen maintenance greater than 84 percent at 36,000 hours, the Caretaker luminaire is virtually maintenance-free for over 15 years.

## Ease of Installation

Installation is made simple with a versatile, universal wall and wood pole mounting bracket. A specially designed support tab on the universal bracket enables the Caretaker luminaire to be positioned and secured in a single step. A hinged power tray door and a single, captive screw allows for safe and easy access when making electrical connections.

## Built to Last

Tough weather conditions are no match for the heavy-duty die-cast, aluminum housing. The LED module compartment is rated for IP66, wet location operation in -40°C to 40°C applications ensuring continued performance in extreme weather. A 6kV integral surge protection device protects drivers and LED components.

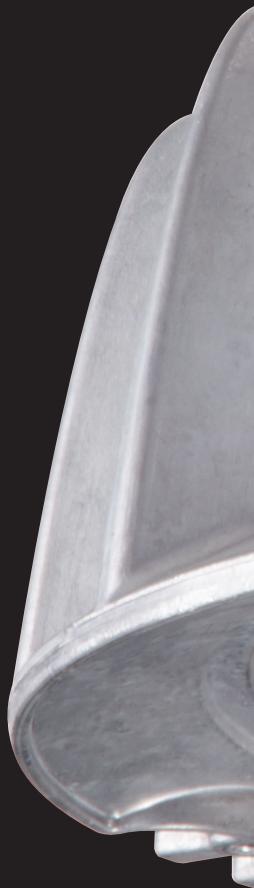

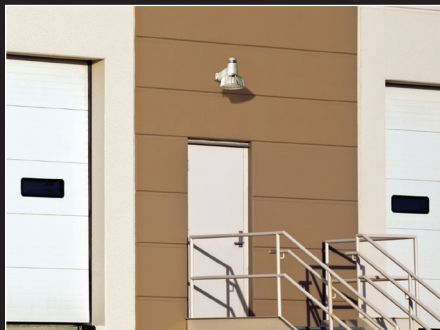

Energy efficiency, high output, easy installation and low maintenance make the Caretaker LED Area Luminaire the best choice for security lighting applications such as perimeter area lighting, loading platforms, residential streetlighting, parking areas, boat docks and access drives.

# Design Performance Features

## Construction

- Heavy-duty, die-cast aluminum door and housing
- Hinged, removable power tray door
- Single-point access with stainless steel captive screw
- UL/cUL wet location listed
- 3G vibration rated
- Universal wall and wood pole mount bracket
- Two-bolt slipfitter for pipe mounting (1-5/8" to 2-3/8" O.D.)

## Electrical

- Ambient temperature rating of -40°C to 40°C (-40°F to 104°F)
- 120V 50/60 Hz
- 6kV surge protection. Class C1 outdoor low compliant per IEEE C62.41
- NEMA twistlock photocontrol for dusk-to-dawn operation
- LED driver mounts to removable power tray door for optimal heat sink and maintenance
- LEDs maintain greater than 84% of initial light output after 36,000 hours (per IESNA TM-21 standards)

## Optical

- IP66 rated LED enclosure
- Injection-molded optics designed for widespread coverage and excellent uniformity
- Thermally optimized 5000K CCT LEDs
- Type V symmetric distribution
- Full cutoff design for Dark Sky compliance

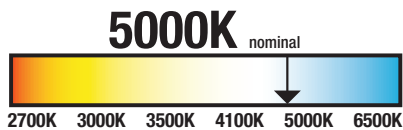

## Optical Refractors

- Small acrylic refractor
- Standard ANSI/NEMA acrylic refractor assembly

## Finish

- Standard raw aluminum finish

## Warranty

- Five-year warranty



## Single-Point Entry and Hinged Door

A single, captive screw and hinged, removable power tray door provides safe and fast access when making electrical connections.

## Mounting Options



### Wall Mount

Wall mounting is simplified with the universal bracket, which can be positioned for either wall or wood pole mounting.

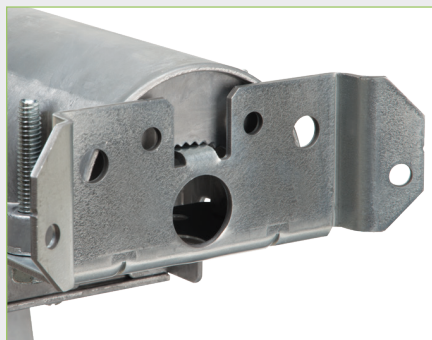

### Wood Pole Mount

Simply rotate the universal bracket with tabs against pole for wood pole mounting.



### Pipe Arm Mount

Retrofit to existing pipe bracket arms with integral two-bolt slipfitter standard for mounting on 1-1/4" to 2" standard pipe (1-5/8" to 2-3/8" O.D.).



### Optional Refractors

Wayfinding principles are utilized in the design of refractors for the Caretaker luminaire to create a sense of security by redirecting light into a desired direction and pattern for increased visibility.

#### < Small Acrylic Refractor

Utilize the small acrylic refractor for enhanced security installations which require increased fixture visibility.

#### ANSI/NEMA Acrylic Refractor >

Compatible with ANSI/NEMA open-bottom refractor to match traditional fixtures.



# Light Distribution and Energy Savings

## Bright, Secure and Uniform Illumination

The Caretaker LED Area Luminaire is designed to provide maximum security in any application. Combining bright, high-efficiency LEDs with precision-molded optics, the Caretaker luminaire delivers a wide, uniform distribution with excellent vertical illumination for maximum light coverage. With effective thermal management, the LED light engine is optimized for energy-efficient, long-term performance.

## 50W Caretaker LED and 100W High Pressure Sodium Comparison

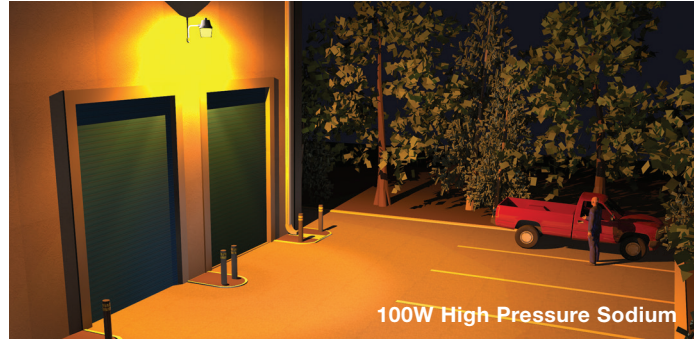

**NOTE:** Typical mounting heights are 10'-30'. Simulation rendering using AGi32 software.

## Lighting Design Guide

The Caretaker LED Area Luminaire is designed for use in a wide variety of applications, including industrial, retail, residential, recreation areas, boat docks, roadways, pathways or anywhere security area lighting is needed. Precision-molded, acrylic optics produce uniform, wide distributions, which allow for mounting heights from as low as 10' above a doorway to as high as a 30' pole.

### Mounting Height/Lamp Comparison

Mounting Height	Light Source	X	Y	Z
15'	50W LED Caretaker Area Luminaire	48'	41'	30'
	70W High Pressure Sodium	38'	33'	26'
	175W Mercury Vapor	47'	37'	25'
	100W Metal Halide	38'	33'	27'
20'	50W LED Caretaker Area Luminaire	56'	45'	32'
	70W High Pressure Sodium	45'	38'	27'
	100W Metal Halide	44'	39'	29'
	100W High Pressure Sodium	52'	43'	33'
25'	50W LED Caretaker Area Luminaire	62'	49'	29'
	100W Metal Halide	51'	44'	27'
	100W High Pressure Sodium	57'	47'	32'
	175W Metal Halide	61'	44'	28'

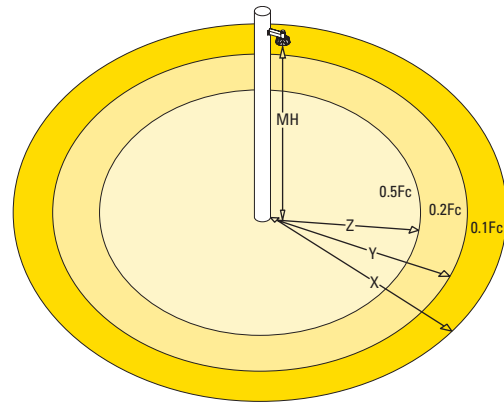

## Reduced Energy Consumption

Operating and maintenance costs of a lighting system are dramatically impacted by the specified lamp source and electrical system. Total system input watts and fixture operating life should be the driving considerations when addressing energy consumption and total cost of ownership. Energy savings increase when energy consumption is reduced and maintenance intervals are extended.

### Annualized Energy Savings/Cost Comparison

Wattage / Lamp Type	Hours Per Day / Year	Life (Hours)	System Wattage	Cost / Year at \$0.10 kWh*	Annual Maintenance Cost*	Total Annual Cost / Fixture	Annual Savings per Fixture	Percent of Savings
50W LED Caretaker Area Luminaire	9 / 3,285	72,000	50W	\$16.43	--	\$16.43	\$71.23	81%
70W High Pressure Sodium		16,000	86W	\$28.25	\$59.40	\$87.65		
50W LED Caretaker Area Luminaire	9 / 3,285	72,000	50W	\$16.43	--	\$16.43	\$110.32	87%
175W Mercury Vapor		16,000	205W	\$67.34	\$59.40	\$126.74		
50W LED Caretaker Area Luminaire	9 / 3,285	72,000	50W	\$16.43	--	\$16.43	\$110.82	87%
100W Metal Halide		12,000	128W	\$42.05	\$85.20	\$127.25		
50W LED Caretaker Area Luminaire	9 / 3,285	72,000	50W	\$16.43	--	\$16.43	\$89.62	85%
100W High Pressure Sodium		16,000	130W	\$42.71	\$63.34	\$106.04		
50W LED Caretaker Area Luminaire	9 / 3,285	72,000	50W	\$16.43	--	\$16.43	\$197.59	92%
175W Metal Halide		7,000	210W	\$68.99	\$145.03	\$214.01		

\* Nominal lumens prior to optical and configuration losses based on 5000K CCT at 40°C. Caretaker 5,212 lumens. Hours of life based on 70% lumen maintenance. Cost = (Watts x 9 Hours Per Day x 365 Days Per Year) / 1000 = Daily Kilowatt hour (kWh). kWh x .10 cents/kWh = Cost/year at .10 kWh. Re-lamp based on selected technology. Maintenance cost includes lamp and labor.

# Ordering Information

Stock Sample Number: CTKRV1A

Product Family	Wattage	Driver	LED Kelvin (CCT)	Photocontrol	Mounting	Accessories (Order Separately)
CTKRV1A=Caretaker	50W	120V	5000K	NEMA Twistlock	Wall/Pole Mount Bracket and Integral Slipfitter	SR-Caretaker=Small Acrylic Refractor RMARROA5=ANSI/NEMA Acrylic Refractor Assembly

## Dimensions

### Full Cutoff

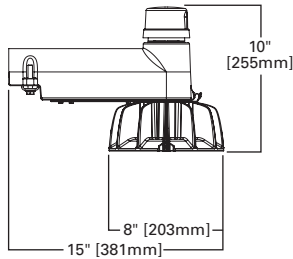

### Small Acrylic Refractor

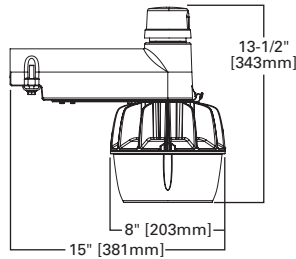

### ANSI/NEMA Acrylic Refractor Assembly

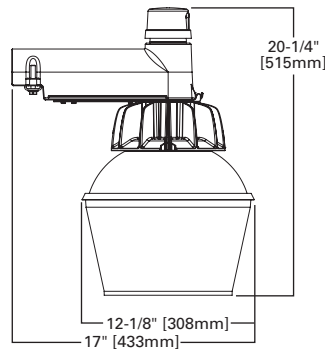

### Wall/Pole Mounting Bracket (Included)

#### Wall Mount

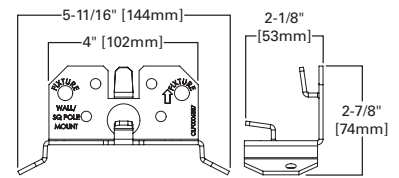

#### Pole Mount

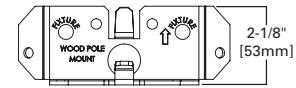

## Power and Lumens

CCT (Color Temperature)	5000K
Power (Watts)	50W
Input Current @ 120V (A)	0.41
Optics	
Type V	
Lumens	5,212
BUG Rating	3-0-1

## Lumen Multiplier

Ambient Temperature	Lumen Multiplier
10°C	1.04
15°C	1.03
25°C	1.00
40°C	0.96

## Lumen Maintenance

Ambient Temperature	TM-21 Lumen Maintenance (36,000 Hours)	Theoretical L70 (Hours)
25°C	> 86%	> 87,000
40°C	> 84%	> 72,000

## Additional Information

Compliances	Technical Data (Electronic LED Driver)	EPA Effective Projected Area (Square Feet)	Shipping Data (Approximate Net Weight)
UL and cUL Wet Location Listed UL1598 Listed IP66 Rated LED Array 3G Vibration Rated DesignLights Consortium® Qualified Lighting Fact® Registered LM79/LM80 Compliant RoHS Compliant	> 0.9 Power Factor < 20% Total Harmonic Distortion 120V 50/60Hz -40°C Minimum Ambient Temperature Rating +40°C Maximum Ambient Temperature Rating	0.67	8.0 lbs. (3.6 kgs.)



NOTE: Specifications and dimensions subject to change without notice.

### **Lighting Product Lines**

Halo  
Halo Commercial  
Portfolio  
Iris  
RSA  
Metalux  
Corelite  
Neo-Ray  
Fail-Safe  
MWS  
Ametrix  
Shaper  
io  
Lumark  
McGraw-Edison  
Invue  
Ephesus  
Lumière  
Streetworks  
AtLite  
Sure-Lites

### **Controls Product Lines**

Greengate  
iLumin  
Zero 88  
Fifth Light Technology  
iLight (International Only)

### **Connected Lighting Systems**

LumaWatt Pro  
WaveLinx  
Distributed Low-Voltage Power  
ConnectWorks