



Quality Products. Service Excellence.

## Inner Panels *EP Series*

### Eclipse Series Enclosures



### Features

- Larger than standard NEMA panel used in same sized enclosure.
- 12gauge steel construction.
- Larger sizes have 2 or 4 formed flanges for added strength.
- Slotted corner design for easier mounting.
- Finished in white or unpainted galvanized.

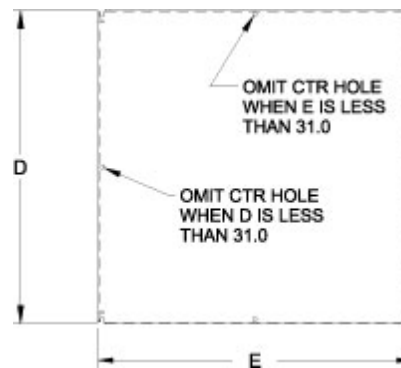

| Mild Steel Galvanized |          | Size  |       | Gauge |
|-----------------------|----------|-------|-------|-------|
| Part No.              | Part No. | D     | E     |       |
| EP1210                | EPG1210  | 10.20 | 8.20  | 12    |
| EP1212                | EPG1212  | 10.20 | 10.20 | 12    |
| EP1224                | EPG1224  | 10.20 | 22.20 | 12    |
| EP1612                | EPG1612  | 14.20 | 10.20 | 12    |
| EP1616                | EPG1616  | 14.20 | 14.20 | 12    |
| EP1620                | EPG1620  | 14.20 | 18.20 | 12    |
| EP2012                | EPG2012  | 18.20 | 10.20 | 12    |
| EP2016                | EPG2016  | 18.20 | 14.20 | 12    |
| EP2020                | EPG2020  | 18.20 | 18.20 | 12    |
| EP2024                | EPG2024  | 18.20 | 22.20 | 12    |
| EP2412                | EPG2412  | 22.20 | 10.20 | 12    |
| EP2416                | EPG2416  | 22.20 | 14.20 | 12    |
| EP2420                | EPG2420  | 22.20 | 18.20 | 12    |
| EP2424                | EPG2424  | 22.20 | 22.20 | 12    |
| EP2430                | EPG2430  | 22.20 | 28.20 | 12    |
| EP2442                | EPG2442  | 22.20 | 40.20 | 12    |
| EP2448                | EPG2448  | 22.20 | 46.20 | 12    |
| EP3012                | EPG3012  | 28.20 | 10.20 | 12    |
| EP3016                | EPG3016  | 28.20 | 14.20 | 12    |
| EP3020                | EPG3020  | 28.20 | 18.20 | 12    |
| EP3024                | EPG3024  | 28.20 | 22.20 | 12    |

| Mild Steel Galvanized |          | Size  |       | Gauge |
|-----------------------|----------|-------|-------|-------|
| Part No.              | Part No. | D     | E     |       |
| EP3030                | EPG3030  | 28.20 | 28.20 | 12    |

| Part No. | Mild Steel Galvanized Part No. | Size  |       |       |
|----------|--------------------------------|-------|-------|-------|
|          |                                | D     | E     | Gauge |
| EP3036   | EPG3036                        | 28.20 | 34.20 | 12    |
| EP3042   | EPG3042                        | 28.20 | 40.20 | 12    |
| EP3048   | EPG3048                        | 28.20 | 46.20 | 12    |
| EP3060   | EPG3060                        | 28.20 | 58.20 | 12    |
| EP3624   | EPG3624                        | 34.20 | 22.20 | 12    |
| EP3630   | EPG3630                        | 34.20 | 28.20 | 12    |
| EP3636   | EPG3636                        | 34.20 | 34.20 | 12    |
| EP3642   | EPG3642                        | 34.20 | 40.20 | 12    |
| EP3648   | EPG3648                        | 34.20 | 46.20 | 12    |
| EP3660   | EPG3660                        | 34.20 | 58.20 | 12    |
| EP4224   | EPG4224                        | 40.20 | 22.20 | 12    |
| EP4230   | EPG4230                        | 40.20 | 28.20 | 12    |
| EP4236   | EPG4236                        | 40.20 | 34.20 | 12    |
| EP4824   | EPG4824                        | 46.20 | 22.20 | 12    |
| EP4830   | EPG4830                        | 46.20 | 28.20 | 12    |
| EP4836   | EPG4836                        | 46.20 | 34.20 | 12    |
| EP4848   | EPG4848                        | 46.20 | 46.20 | 12    |
| EP6036   | EPG6036                        | 58.20 | 34.20 | 12    |
| EP7230   | EPG7230                        | 70.20 | 28.20 | 12    |
| EP7236   | EPG7236                        | 70.20 | 34.20 | 12    |

Tags: inner panel, galvanized, steel, Eclipse, EN4SD, EP

*Data subject to change without notice*

© 2024. Hammond Manufacturing Ltd. All rights reserved.



Quality Products. Service Excellence.

## Inner Panels *EP Series*

### Eclipse Series Enclosures



### Features

- Larger than standard NEMA panel used in same sized enclosure.
- 12gauge steel construction.
- Larger sizes have 2 or 4 formed flanges for added strength.
- Slotted corner design for easier mounting.
- Finished in white or unpainted galvanized.

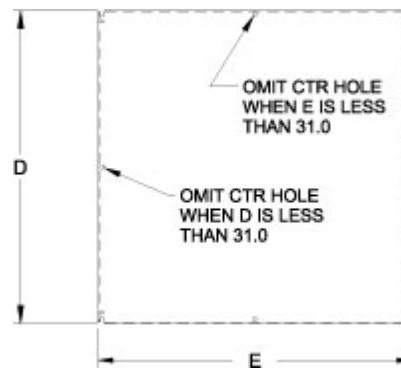

| Mild Steel Galvanized |          | Size  |       |       |
|-----------------------|----------|-------|-------|-------|
| Part No.              | Part No. | D     | E     | Gauge |
| EP1210                | EPG1210  | 10.20 | 8.20  | 12    |
| EP1212                | EPG1212  | 10.20 | 10.20 | 12    |
| EP1224                | EPG1224  | 10.20 | 22.20 | 12    |
| EP1612                | EPG1612  | 14.20 | 10.20 | 12    |
| EP1616                | EPG1616  | 14.20 | 14.20 | 12    |
| EP1620                | EPG1620  | 14.20 | 18.20 | 12    |
| EP2012                | EPG2012  | 18.20 | 10.20 | 12    |
| EP2016                | EPG2016  | 18.20 | 14.20 | 12    |
| EP2020                | EPG2020  | 18.20 | 18.20 | 12    |
| EP2024                | EPG2024  | 18.20 | 22.20 | 12    |
| EP2412                | EPG2412  | 22.20 | 10.20 | 12    |
| EP2416                | EPG2416  | 22.20 | 14.20 | 12    |
| EP2420                | EPG2420  | 22.20 | 18.20 | 12    |
| EP2424                | EPG2424  | 22.20 | 22.20 | 12    |
| EP2430                | EPG2430  | 22.20 | 28.20 | 12    |
| EP2442                | EPG2442  | 22.20 | 40.20 | 12    |
| EP2448                | EPG2448  | 22.20 | 46.20 | 12    |
| EP3012                | EPG3012  | 28.20 | 10.20 | 12    |
| EP3016                | EPG3016  | 28.20 | 14.20 | 12    |
| EP3020                | EPG3020  | 28.20 | 18.20 | 12    |
| EP3024                | EPG3024  | 28.20 | 22.20 | 12    |

| Mild Steel Galvanized |          | Size  |       |       |
|-----------------------|----------|-------|-------|-------|
| Part No.              | Part No. | D     | E     | Gauge |
| EP3030                | EPG3030  | 28.20 | 28.20 | 12    |

| Part No. | Mild Steel Galvanized Part No. | Size  |       |       |
|----------|--------------------------------|-------|-------|-------|
|          |                                | D     | E     | Gauge |
| EP3036   | EPG3036                        | 28.20 | 34.20 | 12    |
| EP3042   | EPG3042                        | 28.20 | 40.20 | 12    |
| EP3048   | EPG3048                        | 28.20 | 46.20 | 12    |
| EP3060   | EPG3060                        | 28.20 | 58.20 | 12    |
| EP3624   | EPG3624                        | 34.20 | 22.20 | 12    |
| EP3630   | EPG3630                        | 34.20 | 28.20 | 12    |
| EP3636   | EPG3636                        | 34.20 | 34.20 | 12    |
| EP3642   | EPG3642                        | 34.20 | 40.20 | 12    |
| EP3648   | EPG3648                        | 34.20 | 46.20 | 12    |
| EP3660   | EPG3660                        | 34.20 | 58.20 | 12    |
| EP4224   | EPG4224                        | 40.20 | 22.20 | 12    |
| EP4230   | EPG4230                        | 40.20 | 28.20 | 12    |
| EP4236   | EPG4236                        | 40.20 | 34.20 | 12    |
| EP4824   | EPG4824                        | 46.20 | 22.20 | 12    |
| EP4830   | EPG4830                        | 46.20 | 28.20 | 12    |
| EP4836   | EPG4836                        | 46.20 | 34.20 | 12    |
| EP4848   | EPG4848                        | 46.20 | 46.20 | 12    |
| EP6036   | EPG6036                        | 58.20 | 34.20 | 12    |
| EP7230   | EPG7230                        | 70.20 | 28.20 | 12    |
| EP7236   | EPG7236                        | 70.20 | 34.20 | 12    |

Tags: inner panel, galvanized, steel, Eclipse, EN4SD, EP

*Data subject to change without notice*

© 2024. Hammond Manufacturing Ltd. All rights reserved.