

Montageanweisung
Installation Instructions
Notice d'installation
Istruzioni per il montaggio

Instrucciones de montaje
Инструкция по монтажу
安装说明

FAZ-...
AZ-...

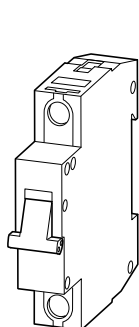

FAZ-...

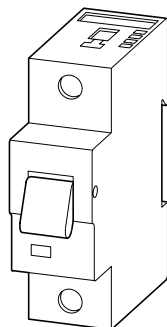

AZ-...

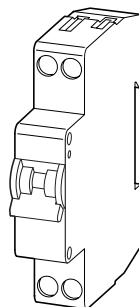

FAZ-PN-...



Lebensgefahr durch elektrischen Strom!

Nur Elektrofachkräfte und elektrotechnisch unterwiesene Personen dürfen die im Folgenden beschriebenen Arbeiten ausführen.

Electric current! Danger to life!

Only skilled or instructed persons may carry out the following operations.

Tension électrique dangereuse !

Seules les personnes qualifiées et averties doivent exécuter les travaux ci-après.

Tensione elettrica: Pericolo di morte!

Solo persone abilitate e qualificate possono eseguire le operazioni di seguito riportate.

¡Corriente eléctrica! ¡Peligro de muerte!

El trabajo a continuación descrito debe ser realizado por personas cualificadas y advertidas.

Электрический ток! Опасно для жизни!



Только специалисты или проинструктированные лица могут выполнять следующие операции.

触电危险!

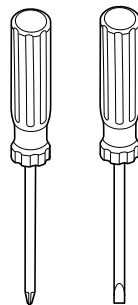
只允许专业人员和受过专业培训的人员进行下列工作。



Z 2

	FAZ-...	AZ-...	FAZ-PN-...
	1 × (1 – 25) mm ²	1 × (2.5 – 50) mm ²	1 × (1 – 16) mm ²
	2 × (1 – 10) mm ²	2 × (2.5 – 25) mm ²	2 × (1 – 6) mm ²
	1 × (0.75 – 16) mm ²	–	1 × (0.75 – 10) mm ²
DIN 46228	2 × (4 – 6) mm ²	2 × (2.5 – 16) mm ²	2 × (1 – 4) mm ²
	2.4 Nm	3.0 Nm	1.5 Nm

FAZ-...-C...-DC

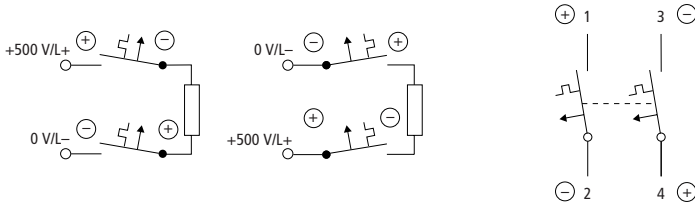
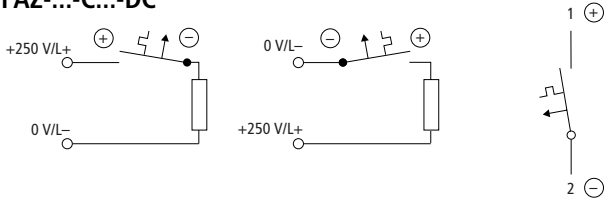

FAZ-XIS..., FAZ-(PN-...), FAZ-...-NA



07/01 AWA1220-1755

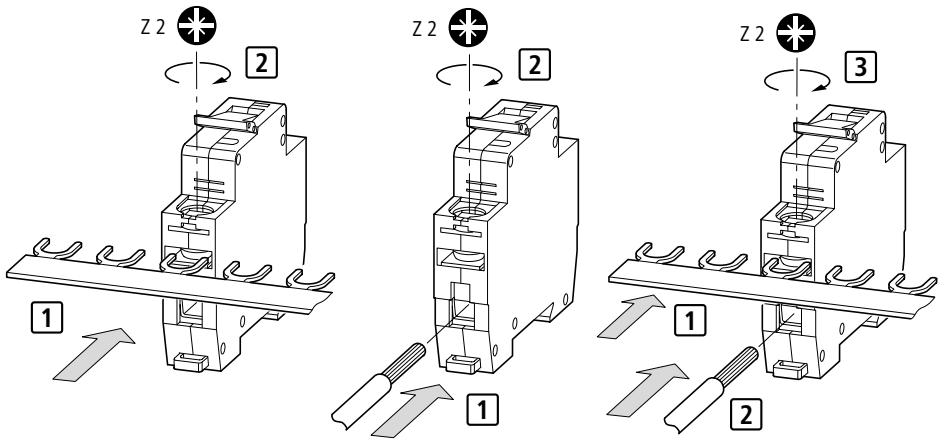

Supplementary Protector Technical Data

FAZB
FAZC; (FAZ-...-C...-DC)
FAZR
FAZS

1 phase:
5 kA – 277 V ~ 60 Hz
3 phase:
5 kA – 277/480 V ~ 60 Hz

USA/Canada
UL 1077
CSA 22.2 No. 235 – M89

6 A to 40 A
0.5 A to 40 A
6 A to 40 A
1 A to 16 A

Tripping Current:
155 % of rated current
at 30 °C
Cu 75 °C, min. AWG 18,
max. AWG 8; Nm 2.4

Circuit Breaker UL 489 FAZ-...-NA

Spacings for multiple pole installations where breakers are mounted adjacent to each other and are connected to different polarity circuits must be maintained as following:

Through Air	19.1 mm
Over Surface	31.8 mm

In conjunction with an upstream device fuse up to $4 \times I_n$