

Round Cut-in Floor Box Kits

NEW!
more on
reverse

Flush-to-Floor Installation in Existing Wood and Concrete Floors



Arlington's round, cut-in **FLOOR BOX KITS** offer installers the low cost, *convenient* way to install a duplex receptacle *flush with the floor*.

The 3.5" round, UL Listed non-metallic **floor box** is easy to install in an *existing* wood or concrete floor. Electrical conduit must be accessible from underneath the floor if installing in existing concrete.

Hide miscut flooring, cover the edges of cut carpet and get a neater finish with an **oversized ring** or **carpet ring** to match your cover.

Complete the job with a round 4" **metal cover** in brass or nickel-plated brass.



Floor Box Kit
with brass cover
FLB3520MB

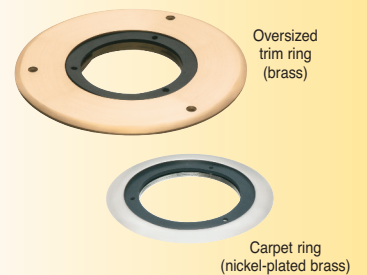

1 Using a 4" diameter hole saw, cut opening in floor approximately 1/2" deep, taking care to avoid structural framing members.



2 Next, use a 3-1/2" hole saw to cut through the remaining flooring/subfloor, creating a shelf at the desired depth for the box. Remove material that remains between the saw cuts.

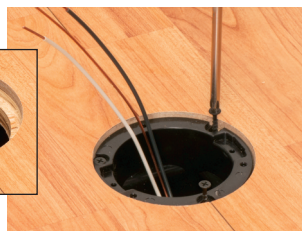

3 Pull cable. Install in box with supplied cable connector. Attach box to floor with (3) #6 x 1-1/4" wood screws (not supplied) through the U-shaped cut outs in the box flange.



4 Wire receptacle. Install in box.



5 Attach plastic gasket support plate to receptacle with #6 x 1/2" screw. Install gasket.



6 Attach cover to box with (3) #8 x 1/2" flat head machine screws.

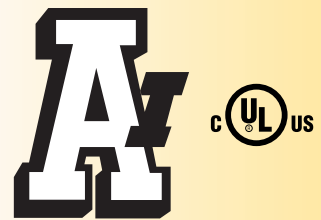

Arlington

1 Stauffer Industrial Park
Scranton, PA 18517
800/233.4717
Fax 570/562.0646
www.aifittings.com

Non-Metallic Floor Box Kits, Cover Trim Kits

Round Metal Cover • Easy to Install in Existing Floor



CATALOG NUMBER	UPC/DCI/NAED MFG. #018997	DESCRIPTION FINISH/COLOR, COVER STYLE	UNIT PKG	STD PKG
FLB3500	00733	3.5" Non-metallic ROUND CUT-IN BOX for Existing Wood or Concrete Floors	4	4

FLOOR BOX KITS WITH METAL COVERS

FLB3520MB	00734	FLOOR BOX KIT Round cut-in box, Brass cover w threaded plugs	1	1
FLB3520NL	00735	FLOOR BOX KIT Round cut-in box, Nickel-plated Brass cover w threaded plugs	1	1

FLB3520MB and FLB3520NL FLOOR BOX KITS include non-metallic box, round metal cover, non-metallic gasket support plate, gasket, UL Listed 15 amp TR duplex receptacle, NM94 and NM95 cable connectors, (3) #8 x 1/2" flat head screws and (1) #6 x 1/2" screw.

FLB3520MB brass cover



FLB3520NL nickel-plated brass cover



CATALOG NUMBER	UPC/DCI/NAED MFG. #018997	DESCRIPTION FINISH/COLOR, COVER STYLE	UNIT PKG	STD PKG
CARPET RINGS Cover cut edges of carpet for a neater installation				
FLB3550MB	00738	CARPET RING, BRASS	1	1
FLB3550NL	00739	CARPET RING, NICKEL-PLATED BRASS	1	1
OVERSIZED TRIM RINGS Oversized ring for existing boxes with outsized holes				
FLB3570MB	00740	TRIM RING, BRASS	1	1
FLB3570NL	00741	TRIM RING, NICKEL-PLATED BRASS	1	1



FLB3570MB



FLB3550MB



FLB3550NL

TRIM KITS ROUND METAL COVER WITH THREADED PLUGS, GASKETS, 15 AMP DUPLEX TR RECEPTACLE

FLB3520MBTK	00736	COVER TRIM KIT 4" Round, BRASS	1	1
FLB3520NLTK	00737	COVER TRIM KIT 4" Round, NICKEL-PLATED BRASS	1	1



FLB3520MBTK



FLB3520NLTK

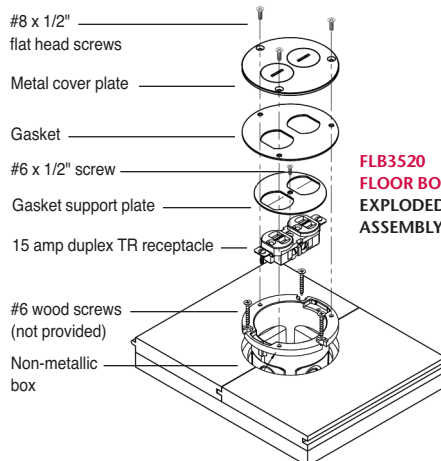

Distributed by

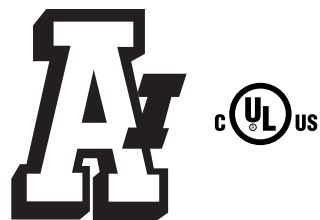

Arlington
1 Stauffer Industrial Park
Scranton, PA 18517
800/233.4717
Fax 570/562.0646
www.aifittings.com

Patents pending FLB3520 0715/25M

Round Cut-in Floor Box Kits

NEW!
more on
reverse

Flush-to-Floor Installation in Existing Wood and Concrete Floors



Arlington's round, cut-in **FLOOR BOX KITS** offer installers the low cost, *convenient* way to install a duplex receptacle *flush with the floor*.

The 3.5" round, UL Listed non-metallic **floor box** is easy to install in an *existing* wood or concrete floor. Electrical conduit must be accessible from underneath the floor if installing in existing concrete.

Hide miscut flooring, cover the edges of cut carpet and get a neater finish with an **oversized ring** or **carpet ring** to match your cover.

Complete the job with a round 4" **metal cover** in brass or nickel-plated brass.



Floor Box Kit
with brass cover
FLB3520MB

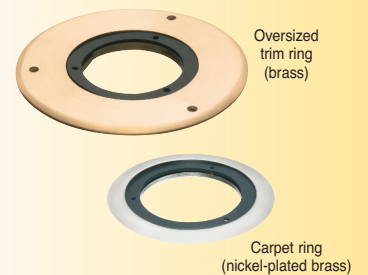

1 Using a 4" diameter hole saw, cut opening in floor approximately 1/2" deep, taking care to avoid structural framing members.

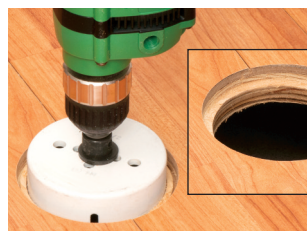

2 Next, use a 3-1/2" hole saw to cut through the remaining flooring/subfloor, creating a shelf at the desired depth for the box. Remove material that remains between the saw cuts.

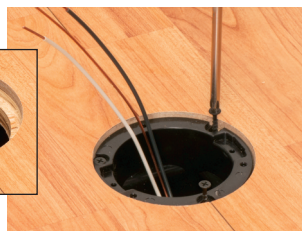

3 Pull cable. Install in box with supplied cable connector. Attach box to floor with (3) #6 x 1-1/4" wood screws (not supplied) through the U-shaped cut outs in the box flange.



4 Wire receptacle. Install in box.



5 Attach plastic gasket support plate to receptacle with #6 x 1/2" screw. Install gasket.



6 Attach cover to box with (3) #8 x 1/2" flat head machine screws.

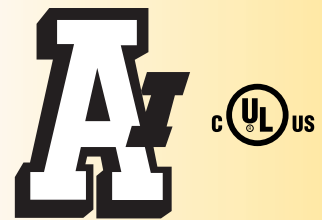

Arlington

1 Stauffer Industrial Park
Scranton, PA 18517
800/233.4717
Fax 570/562.0646
www.aifittings.com

Non-Metallic Floor Box Kits, Cover Trim Kits

Round Metal Cover • Easy to Install in Existing Floor



CATALOG NUMBER	UPC/DCI/NAED MFG. #018997	DESCRIPTION FINISH/COLOR, COVER STYLE	UNIT PKG	STD PKG
FLB3500	00733	3.5" Non-metallic ROUND CUT-IN BOX for Existing Wood or Concrete Floors	4	4

FLOOR BOX KITS WITH METAL COVERS

FLB3520MB	00734	FLOOR BOX KIT Round cut-in box, Brass cover w threaded plugs	1	1
FLB3520NL	00735	FLOOR BOX KIT Round cut-in box, Nickel-plated Brass cover w threaded plugs	1	1

FLB3520MB and FLB3520NL FLOOR BOX KITS include non-metallic box, round metal cover, non-metallic gasket support plate, gasket, UL Listed 15 amp TR duplex receptacle, NM94 and NM95 cable connectors, (3) #8 x 1/2" flat head screws and (1) #6 x 1/2" screw.

FLB3520MB brass cover



FLB3520NL nickel-plated brass cover

CATALOG NUMBER	UPC/DCI/NAED MFG. #018997	DESCRIPTION FINISH/COLOR, COVER STYLE	UNIT PKG	STD PKG
CARPET RINGS Cover cut edges of carpet for a neater installation				
FLB3550MB	00738	CARPET RING, BRASS	1	1
FLB3550NL	00739	CARPET RING, NICKEL-PLATED BRASS	1	1
OVERSIZED TRIM RINGS Oversized ring for existing boxes with outsized holes				
FLB3570MB	00740	TRIM RING, BRASS	1	1
FLB3570NL	00741	TRIM RING, NICKEL-PLATED BRASS	1	1



FLB3570MB



FLB3550MB



FLB3550NL

TRIM KITS ROUND METAL COVER WITH THREADED PLUGS, GASKETS, 15 AMP DUPLEX TR RECEPTACLE

FLB3520MBTK	00736	COVER TRIM KIT 4" Round, BRASS	1	1
FLB3520NLTK	00737	COVER TRIM KIT 4" Round, NICKEL-PLATED BRASS	1	1



FLB3520MBTK



FLB3520NLTK

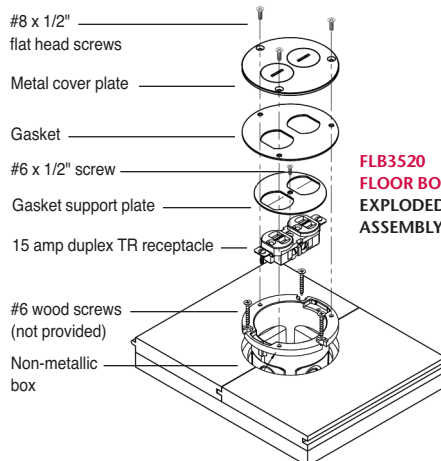

FLB3520 FLOOR BOX KIT EXPLODED ASSEMBLY



Distributed by



Arlington
 1 Stauffer Industrial Park
 Scranton, PA 18517
 800/233.4717
 Fax 570/562.0646
 www.aifittings.com