



Non-metallic and

Metal Covers



PUT A RECEPTACLE IN THE FLOOR THE EASY WAY!

**FLOOR BOX KITS and
Boxes • Covers • Accessories**



NON-METALLIC BOXES THREE STYLES



FLUSH FIT

FOR NEW OR EXISTING FLOORS

Arlington's **UL Listed FLOOR BOX KITS** offer installers the low cost, *convenient* way to put a receptacle in the floor – with a box that installs flush with the floor.

We have a floor box for nearly any job site condition. There's one for new concrete pours, a box for existing floors – and an *adjustable* box that fits most finished floor heights up to 2". All are available with oversized non-metallic or metal covers. And all install flush with the floor surface

COVERS Our non-metallic boxes have gasketed covers that prevent water intrusion – with your choice of threaded plugs or flip lids that protect the receptacle when it's not in use. Best of all, they're oversized to hide miscut flooring!

Arlington's single-gang floor box kits are available with metal or non-metallic covers in a variety of colors and finishes.

Non-metallic in white, black, brown, light almond and **metal** in brass and nickel-plated brass.

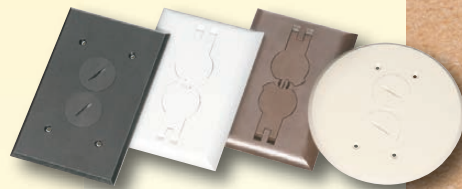

ON EXISTING FLOORS

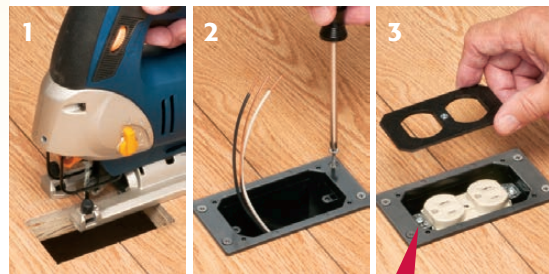
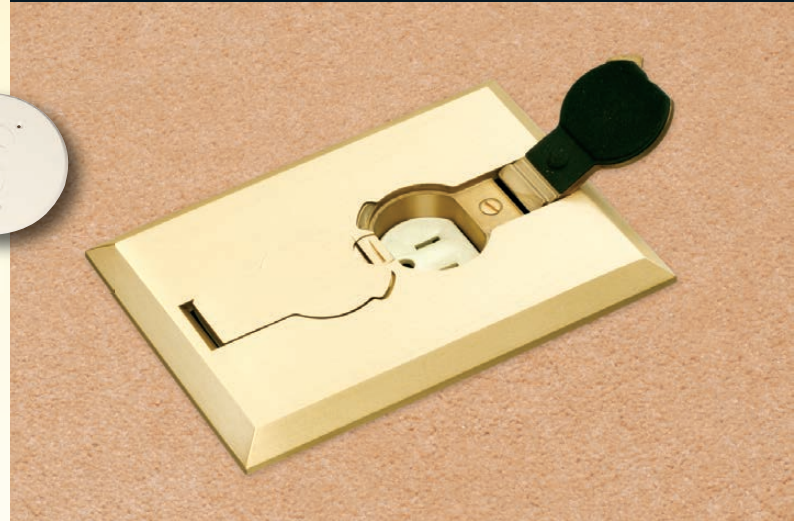

Easy to install in an Existing Floor...Cut the opening...install

See pages 8-15 for INTERCHANGEABLE, COST-EFFECTIVE Single and Two-Gang Floor Box Kits, Boxes, Covers and Accessories.



View Video



FLBR101BR
Rectangular,
Brown Cover

ADJUSTS TO FINAL FLOOR HEIGHT



FOR FLOORS UP TO 2" THICK

FOR NEW CONCRETE POURS

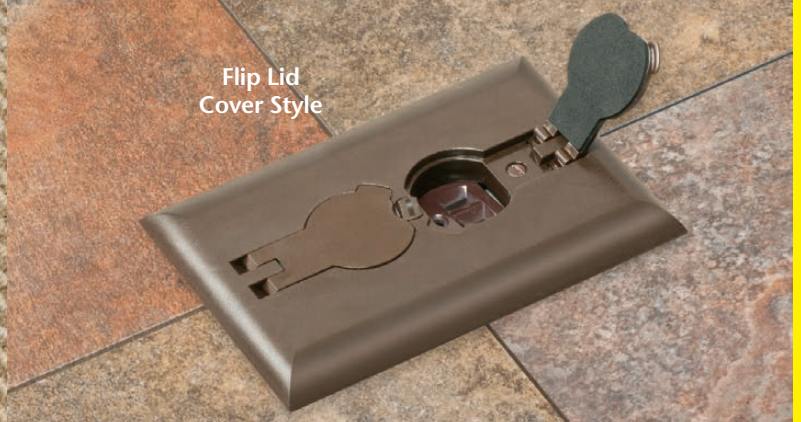

Flip Lid
Cover Style

Supplied with 1/8", 1/4", 1/2" and 3/4" spacers to allow for increases in floor thickness; tile, wood, carpet, etc.

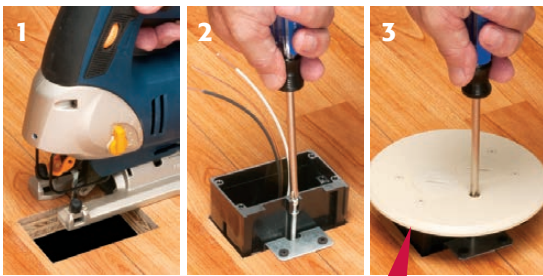

Adjustable boxes for varying floor heights

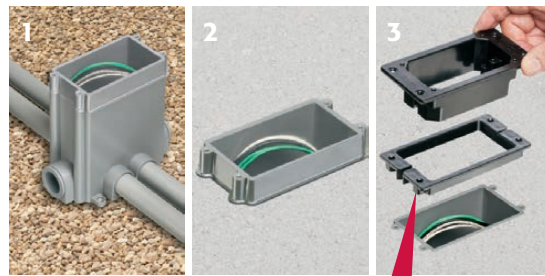

Supplied spacers allow for adjustment to final floor thickness

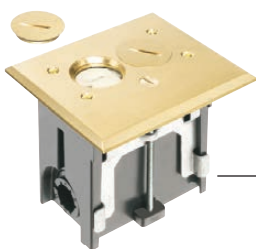

FLBA101MB
Rectangular,
Brass Cover

Adjustable Bracket
positions box
flush with floor



FLBCF101MB
Brass Cover
with Flip Lids

UL LISTED FLOOR BOX KITS

FOR EXISTING FLOORS

FOR EXISTING FLOORS

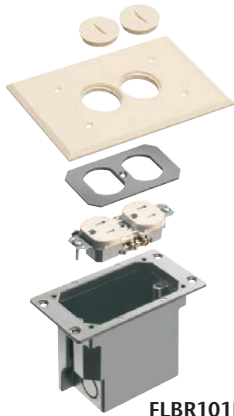

FLBR101LA

| CATALOG NUMBER | UPC/DCI/NAED MFG. #018997 | DESCRIPTION | COVER MATERIAL | COVER STYLE/SHAPE | COVER COLOR | UNIT PKG | STD PKG |
|----------------|---------------------------|---|----------------|--|---------------------|----------|---------|
| FLBRF101W | 16253 | 20.0 cubic inch BOX FOR EXISTING FLOORS | Non-Metallic | RECTANGULAR with TWO FLIP LIDS | White | 1 | 4 |
| FLBRF101LA | 16252 | | Non-Metallic | | Light Almond | 1 | 4 |
| FLBRF101BR | 16251 | | Non-Metallic | | Brown | 1 | 4 |
| FLBRF101BL | 16250 | | Non-Metallic | | Black | 1 | 4 |
| FLBRF101MB | 16254 | | Metal | | Brass | 1 | 4 |
| FLBRF101NL | 16255 | Flush-to-the-floor Installation. Put a receptacle where you need it...easy. | Metal | | Nickel-plated brass | 1 | 4 |
| FLBR101W | 04356 |  | Non-Metallic | RECTANGULAR with TWO THREADED PLUGS | White | 1 | 4 |
| FLBR101LA | 04357 | | Non-Metallic | | Light Almond | 1 | 4 |
| FLBR101BR | 04359 | | Non-Metallic | | Brown | 1 | 4 |
| FLBR101BL | 04358 | | Non-Metallic | | Black | 1 | 4 |
| FLBR101MB | 52263 | | Metal | | Brass | 1 | 4 |
| FLBR101NL | 52453 | | Metal | | Nickel-plated brass | 1 | 4 |

Includes: Floor Box, duplex receptacle, (1) NM94 connector, back plate on non-metallic covers, gasketed cover, (5) #6-32 cover plate screws and threaded plugs or flip lids.

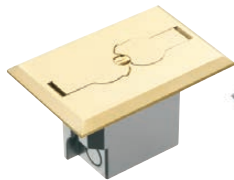

FLBRF101MB



FLBRF101W



FLBRF101BL

Not shown:

FLBRF101NL (Nickel-plated cover with flip lids)

FLBRF101BR (Non-metallic, brown cover with flip lids)



FLBRF101LA

INSTALLS FLUSH WITH FLOOR



FLBR101MB



FLBR101NL



FLBR101BL



FLBR101BR

Not shown:

FLBR101W (Non-metallic, white cover with threaded plugs)



FLBR101LA



View Video



UL LISTED FLOOR BOX KITS

**ADJUSTABLE...
FOR FLOORS
UP TO 2" H**

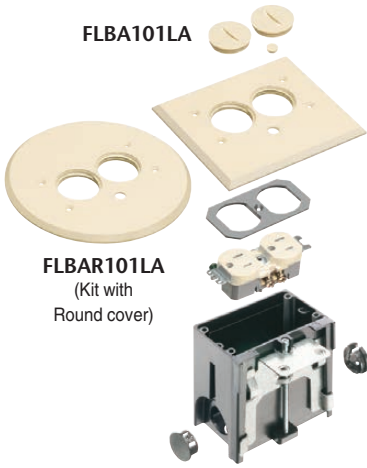

| CATALOG NUMBER | UPC/DCI/NAED MFG. #018997 | DESCRIPTION UL Listed Floor Box Kit | COVER MATERIAL | COVER STYLE/SHAPE | COVER COLOR | UNIT PKG | STD PKG |
|----------------|---------------------------|---|----------------|---------------------------|---------------------|----------|---------|
| FLBAF101W | 04340 | | Non-Metallic | | White | 1 | 4 |
| FLBAF101LA | 04341 | | Non-Metallic | RECTANGULAR | Light Almond | 1 | 4 |
| FLBAF101BR | 04343 | | Non-Metallic | with | Brown | 1 | 4 |
| FLBAF101BL | 04342 | | Non-Metallic | TWO FLIP LIDS | Black | 1 | 4 |
| FLBAF101MB | 13805 | | Metal | | Brass | 1 | 4 |
| FLBAF101NL | 13806 | 18.3 cubic inch ADJUSTABLE BOX | Metal | | Nickel-plated brass | 1 | 4 |
| FLBA101W | 04344 | Fits most finished floor heights up to 2" | Non-Metallic | RECTANGULAR | White | 1 | 4 |
| FLBA101LA | 04345 | | Non-Metallic | with | Light Almond | 1 | 4 |
| FLBA101BR | 04347 | | Non-Metallic | TWO THREADED PLUGS | Brown | 1 | 4 |
| FLBA101BL | 04346 | | Non-Metallic | | Black | 1 | 4 |
| FLBA101MB | 52259 | | Metal | | Brass | 1 | 4 |
| FLBA101NL | 52450 | | Metal | | Nickel-plated brass | 1 | 4 |
| FLBAR101W | 04348 | | Non-Metallic | ROUND | White | 1 | 4 |
| FLBAR101LA | 04349 | | Non-Metallic | with | Light Almond | 1 | 4 |
| FLBAR101BR | 04351 | | Non-Metallic | TWO THREADED PLUGS | Brown | 1 | 4 |
| FLBAR101BL | 04350 | | Non-Metallic | | Black | 1 | 4 |
| FLBAR101MB | 52261 | | Metal | | Brass | 1 | 4 |
| FLBAR101NL | 52451 | | Metal | | Nickel-plated brass | 1 | 4 |

Includes: Adjustable Floor Box, (1) tamper-resistant ("TR") duplex receptacle, (1) cover plate w/ gasket, flip lids or threaded plugs, (2) #6-32 x 1" long screws, (2) #6 drywall screws, (1) NM94 connector, (1) NM900 plug, (1) cap (covers adjustable screw hole in cover plate)

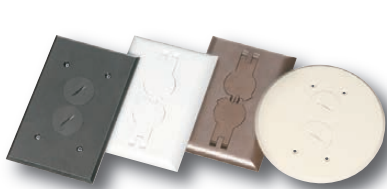

NON-METALLIC COVER COLORS



FLBA101W



FLBAR101BL



FLBA101MB



FLBA101NL

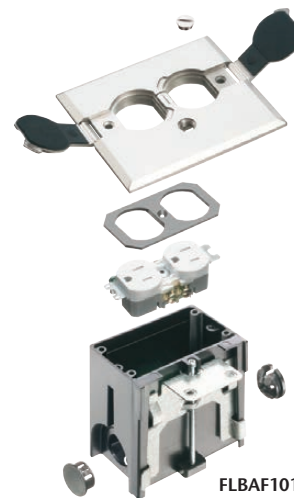
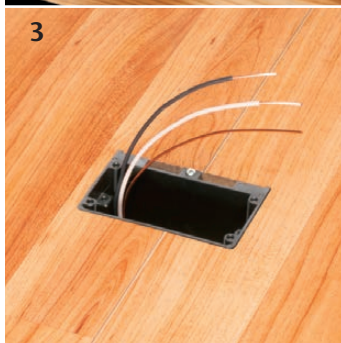
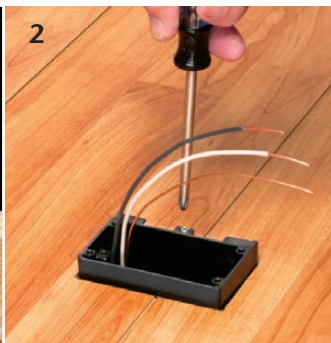

FLBAF101MB

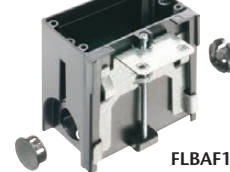

FLBAF101NL



UL LISTED FLOOR BOX KITS

FOR CONCRETE POURS



FOR NEW CONCRETE



FLBCF101BR



FLBC101BL

| CATALOG NUMBER | UPC/DCI/NAED MFG. #018997 | DESCRIPTION UL Listed Floor Box Kit | COVER MATERIAL | COVER STYLE/SHAPE | COVER COLOR | UNIT PKG | STD PKG |
|----------------|---------------------------|---|----------------|--|---------------------|----------|---------|
| FLBCF101W | 06950 | BOX FOR NEW CONCRETE Includes spacers for adjusting box to finished floor height  | Non-Metallic | RECTANGULAR with TWO FLIP LIDS | White | 1 | 1 |
| FLBCF101LA | 06951 | | Non-Metallic | | Light Almond | 1 | 1 |
| FLBCF101BR | 06952 | | Non-Metallic | | Brown | 1 | 1 |
| FLBCF101BL | 06953 | | Non-Metallic | | Black | 1 | 1 |
| FLBCF101MB | 52454 | | Metal | | Brass | 1 | 1 |
| FLBCF101NL | 52455 | | Metal | | Nickel-plated brass | 1 | 1 |
| FLBC101W | 04352 |  | Non-Metallic | RECTANGULAR with TWO THREADED PLUGS | White | 1 | 1 |
| FLBC101LA | 04353 | | Non-Metallic | | Light Almond | 1 | 1 |
| FLBC101BR | 04355 | | Non-Metallic | | Brown | 1 | 1 |
| FLBC101BL | 04354 | | Non-Metallic | | Black | 1 | 1 |
| FLBC101MB | 52265 | | Metal | | Brass | 1 | 1 |
| FLBC101NL | 52452 | | Metal | | Nickel-plated brass | 1 | 1 |

Includes: Concrete box, mud cover, (4) 3/4" plugs, (2) 1" plugs, (1) 1/8" spacer, (1) 1/4" spacer, (1) 1/2" spacer and (1) 3/4" spacer, mounting bracket, duplex receptacle, gasketed cover plate, (5) #6-32 x 1/2" long cover plate screws, (4) #8 x 5/8" long sheet metal screws, (4) #8 x 1-1/4" long sheet metal screws and threaded plugs or flip lids.

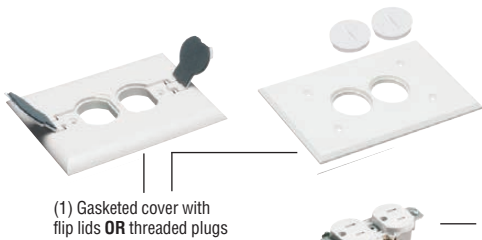

(1) Gasketed cover with flip lids **OR** threaded plugs



FLBC101NL



FLBC101MB

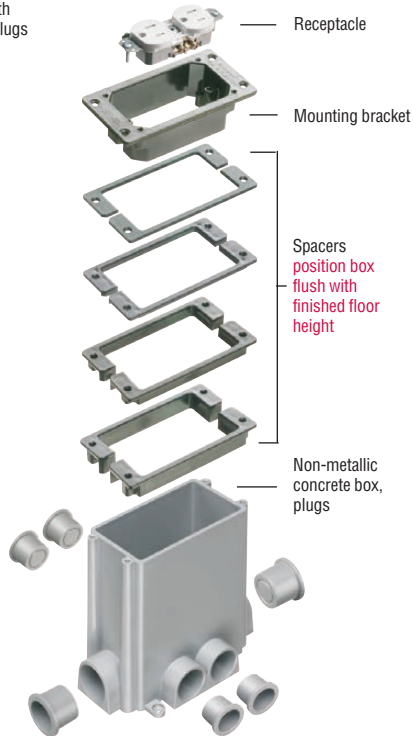

View Video



ROUGH-IN & TRIM KITS

FOR NEW CONCRETE

ROUGH-IN KIT

Non-metallic concrete box and plugs

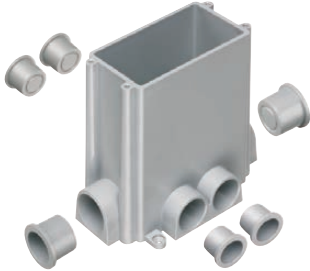

| CATALOG NUMBER | UPC/DCI/NAED MFG. #018997 | DESCRIPTION Rough-In Kit | BOX MATERIAL | COLOR | UNIT PKG | STD PKG |
|----------------|---------------------------|--|--------------|--------------|----------|---------|
| FLBC101RK | 13820 | Non-metallic concrete box, plugs and mud cover | Non-Metallic | Gray plastic | 1 | 1 |

Includes: Concrete box, (4) 3/4" plugs, (2) 1" plugs and mud cover (not shown)

TRIM KIT

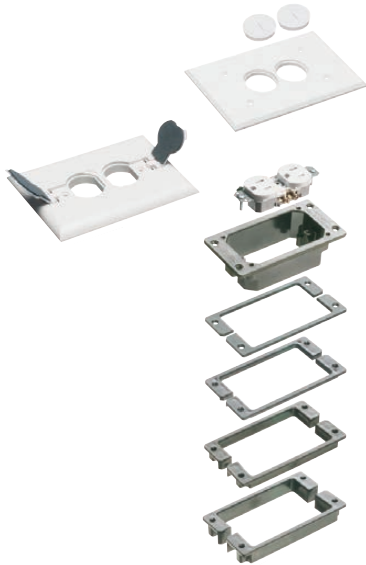

| CATALOG NUMBER | UPC/DCI/NAED MFG. #018997 | DESCRIPTION Trim Kit | COVER MATERIAL | COVER STYLE/SHAPE | COVER COLOR | UNIT PKG | STD PKG |
|----------------|---------------------------|--|----------------|--|---------------------|----------|---------|
| FLBCF101WTK | 13827 | | Non-Metallic | | White | 1 | 1 |
| FLBCF101LATK | 13828 | TRIM KIT | Non-Metallic | RECTANGULAR COVER with TWO FLIP LIDS | Light Almond | 1 | 1 |
| FLBCF101BRTK | 13829 | Includes (4) spacers, mounting bracket, receptacle, (1) gasketed cover with flip lids | Non-Metallic | | Brown | 1 | 1 |
| FLBCF101BLTK | 13830 | | Non-Metallic | | Black | 1 | 1 |
| FLBCF101MBTK | 13831 | | Metal | | Brass | 1 | 1 |
| FLBCF101NLTK | 13832 | | Metal | | Nickel-plated brass | 1 | 1 |
| FLBC101WTK | 13821 | TRIM KIT | Non-Metallic | RECTANGULAR COVER with TWO THREADED PLUGS | White | 1 | 1 |
| FLBC101LATK | 13822 | Includes (4) spacers, mounting bracket, receptacle, (1) gasketed cover with threaded plugs | Non-Metallic | | Light Almond | 1 | 1 |
| FLBC101BRTK | 13823 | | Non-Metallic | | Brown | 1 | 1 |
| FLBC101BLTK | 13824 | | Non-Metallic | | Black | 1 | 1 |
| FLBC101MBTK | 13825 | | Metal | | Brass | 1 | 1 |
| FLBC101NLTK | 13826 | | Metal | | Nickel-plated brass | 1 | 1 |

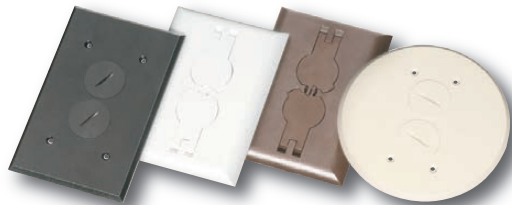

NON-METALLIC COVER COLORS



BRASS & NICKEL-PLATED BRASS METAL COVERS

INTERCHANGEABLE

FLOOR BOX KITS, COVERS, ACCESSORIES

NEW & EXIST

FOR NEW OR EXISTING FLOORS

Arlington's cost-effective **FLOOR BOX KITS** offer installers the low cost, *convenient* way to install a receptacle *flush with the floor* wherever your customer needs one.

This new series of floor box kits, covers and accessories is designed for installation convenience in new and existing floors, and new concrete pours (Page 9) – as well as interchangeability with a variety of other manufacturers' floor boxes.

Available with a **steel** box and a gasketed brass or nickel-plated brass cover to prevent water intrusion, the cover comes with threaded plugs or flip lids to protect the receptacle when it's not in use.

With a variety of floor box kits and individual metal covers and accessories, Arlington offers just about any option you could possibly need...

- Single and two-gang floor box kits...and a *combination* box kit with an installed divider for power and low voltage in the same box.
- Rectangular or square metal covers with flip lids or threaded plugs...also sold separately.



Covers with threaded plugs for two-gang box



Cover with flip lids for single gang (or two-gang) box

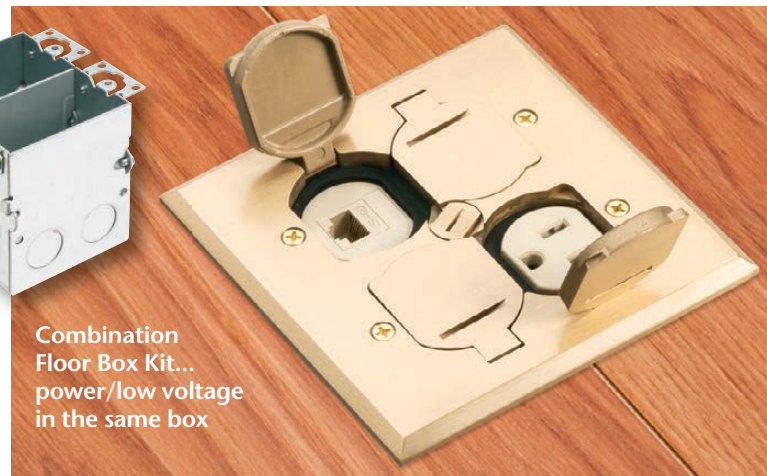
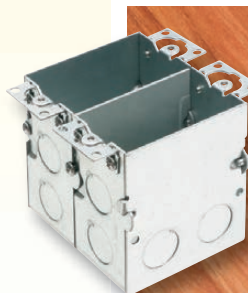

Combination Floor Box Kit... power/low voltage in the same box

COVERS TO FIT OTHER MANUFACTURERS' BOXES FOR GOOD LOOKS ANYWHERE!



ING FLOORS and NEW CONCRETE

Arlington's FLOOR BOX KITS and COVERS **FOR NEW CONCRETE** offer flexibility and convenience.

Made of heavy-duty plastic, our 4.5" non-metallic **concrete box**

is a universal "fits all" size, that accommodates our 6" round covers as well as *most other round covers on the market.*

Our versatile concrete box **covers** are available with flip lids or threaded plugs – in brass or nickel-plated brass. They deliver easier-than-ever installation of receptacles so they'll look great wherever they're installed!

A selection of leveling rings and adapters allows our covers to fit our boxes *and* most other manufacturers' concrete boxes.

For the fastest installation, our trapdoor covers ship *ready to use* with a pre-installed gasket and decorator-style receptacle.



Flip Lid Cover for concrete box



Nickel-plated
FLBT6615NL
(closed)



FLBT6615NL
(open)



Brass Trapdoor style
FLBT6615MB
(open and back)

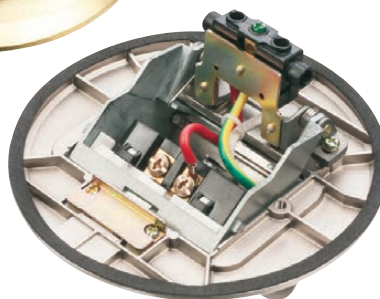

COVERS WITH FLIP LIDS

FLB5331NL
Single-gang with nickel cover

(exploded views)

FLB5551MB
Two-gang with brass cover

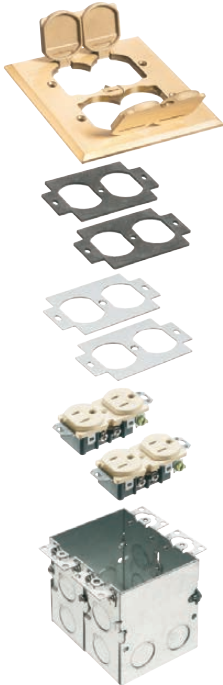
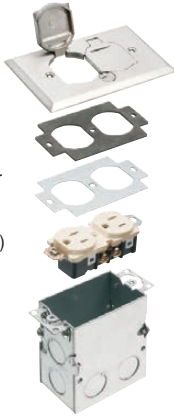

| CATALOG NUMBER | UPC/DCI/NAED MFG. #018997 | DESCRIPTION COVERS WITH FLIP LIDS | COVER SIZE & STYLE | COVER SHAPE | UNIT PKG | STD PKG |
|---|---------------------------|--|-----------------------------------|-------------|----------|---------|
| FLOOR BOX KITS • with STEEL BOX | | | | | | |
| FLB5331MB | 22019 | Single-gang steel box, gaskets, (1) duplex receptacle, gasketed cover, mounting screws | Brass with Two Flip Lids | ■ | 1 | 4 |
| FLB5331NL | 22020 | Single-gang steel box, gaskets, (1) duplex receptacle, gasketed cover, mounting screws | Nickel-plated with Two Flip Lids | ■ | 1 | 4 |
| FLOOR BOX KITS • with STEEL BOX | | | | | | |
| FLB5551MB | 22038 | Two-gang steel box, gaskets, (2) duplex receptacles, gasketed cover, mounting screws | Brass with Four Flip Lids | ■ | 1 | 4 |
| FLB5551NL | 22039 | Two-gang steel box, gaskets, (2) duplex receptacles, gasketed cover, mounting screws | Nickel-plated w/ Four Flip Lids | ■ | 1 | 4 |
| METAL GASKETED COVERS with receptacle | | | | | | |
| FLB5330MB | 22017 | Brass Cover | Single-gang with Two Flip Lids | ■ | 1 | 10 |
| FLB5330NL | 22018 | Nickel-plated Cover | Single-gang with Two Flip Lids | ■ | 1 | 10 |
| FLB5550MB | 22036 | Brass Cover | Two-gang with Four Flip Lids | ■ | 1 | 10 |
| FLB5550NL | 22037 | Nickel-plated Cover | Two-gang with Four Flip Lids | ■ | 1 | 10 |
| FLOOR BOX KITS • with TWO-GANG STEEL COMBO BOX | | | | | | |
| FLB5552MB | 22050 | Two-gang steel box with installed low voltage divider, gaskets, (1) duplex receptacle, (1) low voltage duplex plate, mounting screws | Brass with Four Flip Lids | ■ | 1 | 4 |
| FLB5552NL | 22051 | Two-gang steel box with installed low voltage divider, gaskets, (1) duplex receptacle, (1) low voltage duplex plate, mounting screws | Nickel-plated with Four Flip Lids | ■ | 1 | 4 |

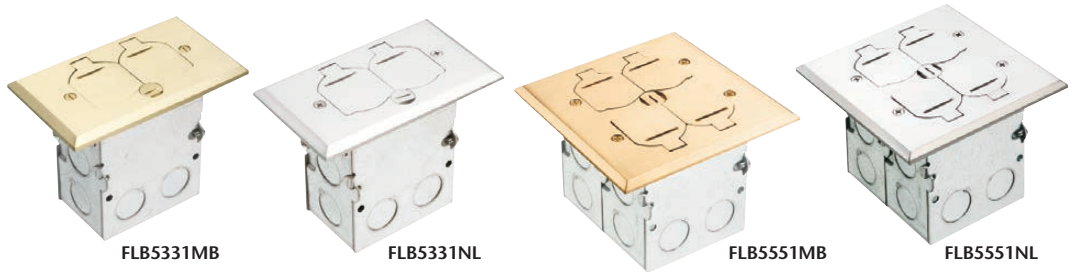

SINGLE & TWO-GANG FLOOR BOX KITS

COMBINATION POWER/LOW VOLTAGE FLOOR BOX KIT



FLB5552MB
Power/Low Voltage Combo Box

FLB5552NL combo box with nickel-plated cover



Divider separates power & low voltage

FLB5552MB



Arlington

| Carlson • T&B | Hubbell | Lew | WireMold • P&S |
|------------------------------------|-----------------------------------|---------------|---------------------------------|
| 71W-DS | B2481 + S3825 (needs receptacle) | SWB-2-LR | 880W1818TCAL (needs receptacle) |
| 71W-DS-N | B2481 + SA3825 (needs receptacle) | SWB-2-LRA | 880W1818TCAL (needs receptacle) |
| 62W + (2) 64-DS (needs receptacle) | B2482 + SB3082 + (2) S3925 | SWB-4-PQ-LR | 880W2827B (needs receptacle) |
| 62W + (2) 64-AL (needs receptacle) | B2482 + SB3082 + (2) SA3825 | SWB-4-PQ-LR | 880W2827B (needs receptacle) |
| P-64-DS | S3825 | RRP-2-LRR | 828R |
| P-64-DS-AL | SA3825 | RRP-2-LR-AR | 828R-TCAL |
| (2) 64-DS | SB3084 + S3825 | RRP-4-BP-LR | (2) 828R |
| (2) 64-DS-AL | SB3082 + (2) SA3825 | RRP-4-PQ-LR-A | (2) 828R-TCAL |
| ---- | ---- | ---- | ---- |
| ---- | ---- | ---- | ---- |

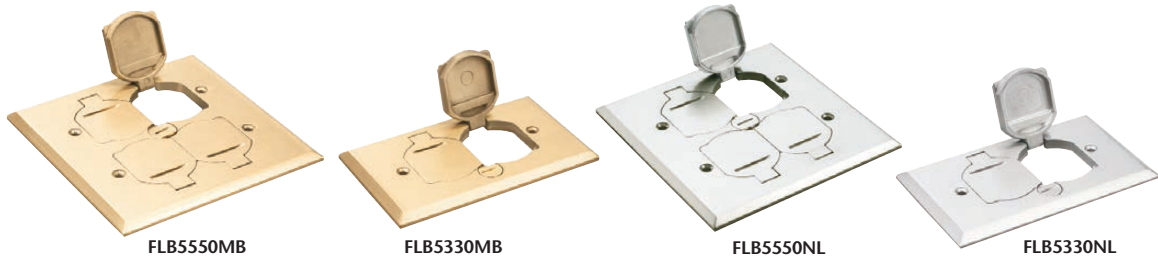

ARLINGTON'S METAL GASKETED COVERS with FLIP LIDS

Arlington's steel floor outlet boxes are compatible with our metal floor box covers on pages 10 and 12. Features include: installed grounding screw, adjustable mounting ears and multiple 1/2" knockouts.

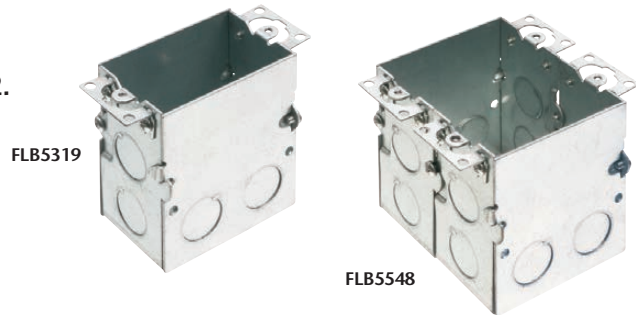

STEEL OUTLET BOXES FOR NEW OR RETROFIT CONSTRUCTION

| CATALOG NUMBER | UPC/DCI/NAED MFG. #018997 | DESCRIPTION | CUBIC INCHES | # OF KNOCKOUTS | UNIT PKG | STD PKG |
|----------------|---------------------------|---|--------------|----------------|----------|---------|
| FLB5319 | 22060 | Single-gang Steel Floor Outlet Box | 18.0 | 9 | 1 | 10 |
| FLB5548 | 22061 | Two-gang Steel Floor Outlet Box | 36.0 | 14 | 1 | 10 |
| FLB5549 | 22062 | Two-gang Steel Floor Combination Box with installed (removable) divider for power/low voltage | 36.0 | 14 | 1 | 10 |



COVERS WITH THREADED PLUGS



FLB5541MB
Floor Box Kit
(exploded view)

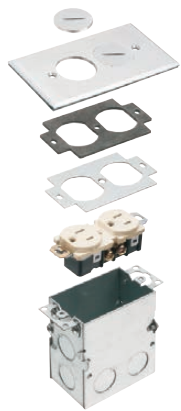

FLB5321NL
(exploded view)

| CATALOG NUMBER | UPC/DCI/NAED MFG. #018997 | DESCRIPTION COVERS WITH FLIP LIDS | COVER SIZE & STYLE | COVER SHAPE | UNIT PKG | STD PKG |
|---|---------------------------|---|--|-------------|----------|---------|
| FLOOR BOX KIT • with STEEL BOX | | | | | | |
| FLB5321MB | 22015 | Single-gang steel box, gaskets, receptacle, gasketed cover, mounting screws | Brass with Two Threaded Plugs | ■ | 1 | 4 |
| FLB5321NL | 22016 | | Nickel-plated with Two Threaded Plugs | ■ | 1 | 4 |
| FLB5541MB | 22034 | Two-gang steel box, gaskets, receptacles, gasketed cover, mounting screws | Brass with Four Threaded Plugs | ■ | 1 | 4 |
| FLB5541NL | 22035 | | Nickel-plated with Four Threaded Plugs | ■ | 1 | 4 |
| METAL GASKETED COVER with receptacle | | | | | | |
| FLB5320MB | 22013 | Brass Cover | Single-gang with Two Threaded Plugs | ■ | 1 | 10 |
| FLB5320NL | 22014 | Nickel-plated Cover | Single-gang with Two Threaded Plugs | ■ | 1 | 10 |
| FLB5540MB | 22005 | Brass Cover | Two-gang with Four Threaded Plugs | ■ | 1 | 10 |
| FLB5540NL | 22033 | Nickel-plated Cover | Two-gang with Four Threaded Plugs | ■ | 1 | 10 |



FLB5321MB



FLB5321NL

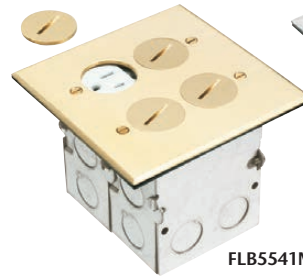

FLB5541MB



FLB5541NL

SINGLE & TWO-GANG FLOOR BOX KITS



FLB5541NL



Arlington

| Carlson • T&B | Hubbell | Lew | WireMold • P&S |
|--------------------------------------|-----------------------------------|------------|----------------------------------|
| 61W + P-64-DU (needs receptacle) | B2481 + S3625 (needs receptacle) | SWB-2 | 880W1+828SPTC (needs receptacle) |
| 61W + P-64-DU-AL (needs receptacle) | B2481 + SA3625 (needs receptacle) | SWB-2-NS | (2) 828SPTC |
| 62W + (2) P-64-DU (needs receptacle) | B2482 + SB3084W + SA3625 | SWB-4-PQ | 880W2 |
| 62W + (2) P-64-DU-AL | B2482 + SA3084 + (2)SA3625 | SWB-4-PQ-A | 880W2 + (2) 828SPTC |
| P-64-DU | S3625 | RRP-2-BR | 828SPTC |
| P-64-DU-AL | SA3625 | RRP-2-NS | ----- |
| (2) P-64-DU | SB3084W + (2) SA3625 | RRP-4-BP | 880W1+(2) 828SPTC |
| (2) P-64-DU-AL | SA3084W + (2) SA3625 | RRP-4-BP-A | (2) 828SPTC |

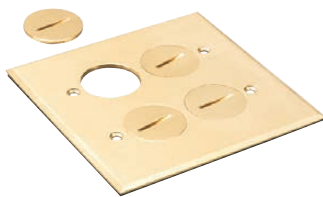

FLB5540MB



FLB5320MB



FLB5540NL



FLB5320NL

ARLINGTON'S METAL GASKETED COVERS with THREADED PLUGS

Arlington's single and two-gang steel floor outlet boxes are compatible with our metal floor box covers on pages 10 and 12.

Features include: installed grounding screw, adjustable mounting ears and multiple 1/2" knockouts.



FLB5319

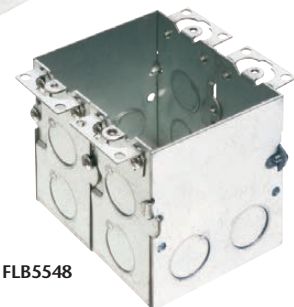

FLB5548

STEEL OUTLET BOXES FOR NEW OR RETROFIT CONSTRUCTION

| CATALOG NUMBER | UPC/DCI/NAED MFG. #018997 | DESCRIPTION | CUBIC INCHES | # OF KNOCKOUTS | UNIT PKG | STD PKG |
|----------------|---------------------------|------------------------------------|--------------|----------------|----------|---------|
| FLB5319 | 22060 | Single-gang Steel Floor Outlet Box | 18.0 | 9 | 1 | 10 |
| FLB5548 | 22061 | Two-gang Steel Floor Outlet Box | 36.0 | 14 | 1 | 10 |

FOR NEW CONCRETE POURS



FLBC4500
(Mud cover in place)

| CATALOG NUMBER | UPC/DCI/NAED MFG. #018997 | DESCRIPTION | NOTES | UNIT PKG | STD PKG |
|-------------------|---------------------------|--|-------------------------------|----------|---------|
| FLBC4500 | 22010 | 4.5" Non-metallic Round Box for Concrete Pours (conduit plugs, mud cover, voltage divider) | | 1 | 5 |
| FLB6230MB | 22025 | Cover Kit 6" Round, Brass w two flip lids | *hole pattern fits FLBC4500LR | 1 | 10 |
| FLB6230NL | 22026 | Cover Kit 6" Round, Nickel-plated w two flip lids | *hole pattern fits FLBC4500LR | 1 | 10 |
| FLB6220MB | 22021 | Cover Kit 6" Round, Brass w two threaded plugs | *hole pattern fits FLBC4500LR | 1 | 10 |
| FLB6220NL | 22022 | Cover Kit 6" Round, Nickel-plated w two threaded plugs | *hole pattern fits FLBC4500LR | 1 | 10 |
| FLBC4500LR | 22011 | Leveling Ring for Arlington FLBC4500 & above round covers (has bosses for cover mounting) | | 1 | 10 |
| FLBT6615MB | 22030 | Trapdoor Cover Round, Brass. Pre-mounted gasket & decorator-style 15A receptacle | | 1 | 10 |
| FLBT6615NL | 22031 | Trapdoor Cover Round, Nickel-plated. Pre-mounted gasket & decorator-style 15A receptacle | | 1 | 10 |
| FLBT6615LR | 22029 | Leveling Ring for Arlington FLBC4500 box w FLBT6615 trapdoor style cover | | 1 | 10 |
| FLBC4500AR | 22004 | Oversized Adapter Ring for 5" diameter concrete boxes | | 1 | 10 |
| FLBC4500Y | 22012 | "Y" Adapter - Provides (2) 1" openings for conduit entering 1" hub | | 1 | 10 |

NON-METALLIC CONCRETE BOX

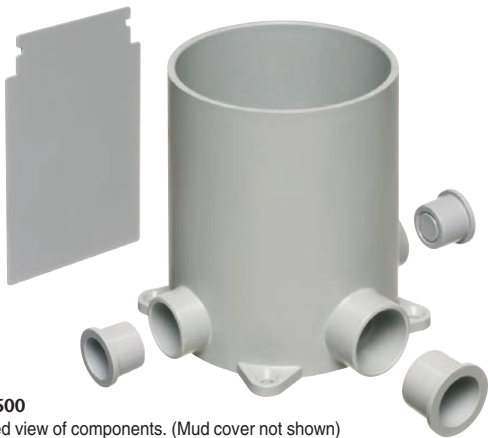

FLBC4500
Exploded view of components. (Mud cover not shown)

COVER KITS with FLIP LIDS

FLB6230MB
Brass cover

Includes cover with flip lids, gaskets, receptacle.

Also available with Nickel-plated cover **FLB6230NL** (not shown)



COVER KITS with THREADED PLUGS

FLB6220MB
Brass cover

Includes cover with threaded plugs, gaskets, receptacle.

FLB6220NL
Nickel-plated cover

(NOT SHOWN)

LEVELING RING

Hole pattern fits above round covers:
FLB6230MB
FLB6230NL
FLB6220MB
FLB6220NL

FLBC4500LR

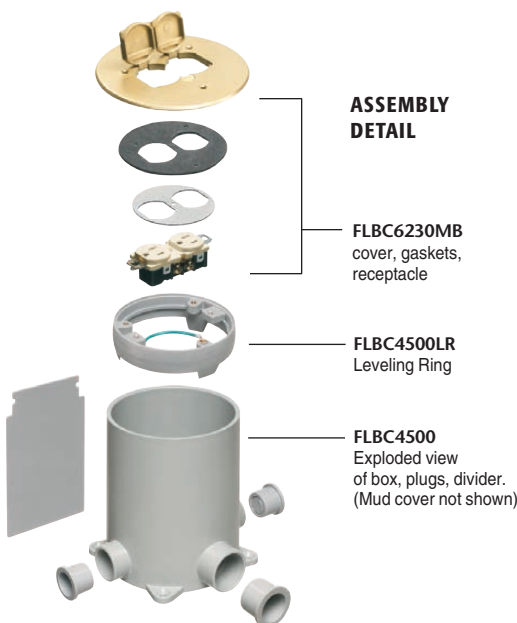
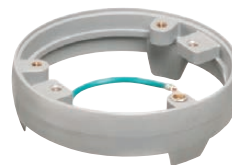

| Carlson • T&B | Hubbell | Lew | WireMold • P&S |
|-----------------|---------------|----------|------------------------|
| E971FB, 68P | PFB1 | FB | 881 E971FB, 68P |
| E97BR2, P60DS | S3925 + S3082 | TCP-2-LR | 895T E97BR2, P60DS |
| E97SS2, P60CACP | ----- | TCP-LR-A | 895 E97SS2, P60CACP |
| P-60-DUP-60-CP | S3725 + S3082 | TCP-2 | 895SP P-60-DUP-60-CP |
| ----- | ----- | ----- | ----- |
| E97ABR2, 68-PAR | PFBA1 | LRA | 881ADP E97ABR2, 68-PAR |
| ----- | ----- | PUFP-BD | ----- |
| ----- | ----- | PUFF-SD | ----- |
| ----- | ----- | PUFF-LRA | ----- |
| ----- | ----- | LRA-HT | ----- |
| E972Y | PFBYA1 | Y-CONN | N/A E972Y |

ARLINGTON'S TRAPDOOR COVERS & LEVELING RING



FLBT6615MB
Trapdoor cover
(open & closed)



FLBT6615NL
Trapdoor cover



FLBT6615LR
Leveling Ring
for trapdoor covers



FLBT6615MB
Trapdoor cover
on **FLBC4500**
Concrete box



FLBT6615NL

ARLINGTON'S ADAPTERS



FLBC4500AR
Oversized
Adapter Ring



FLBC4500Y
"Y" Adapter



FLOOR BOX KITS

FOR GOOD
LOOKS
ANYWHERE

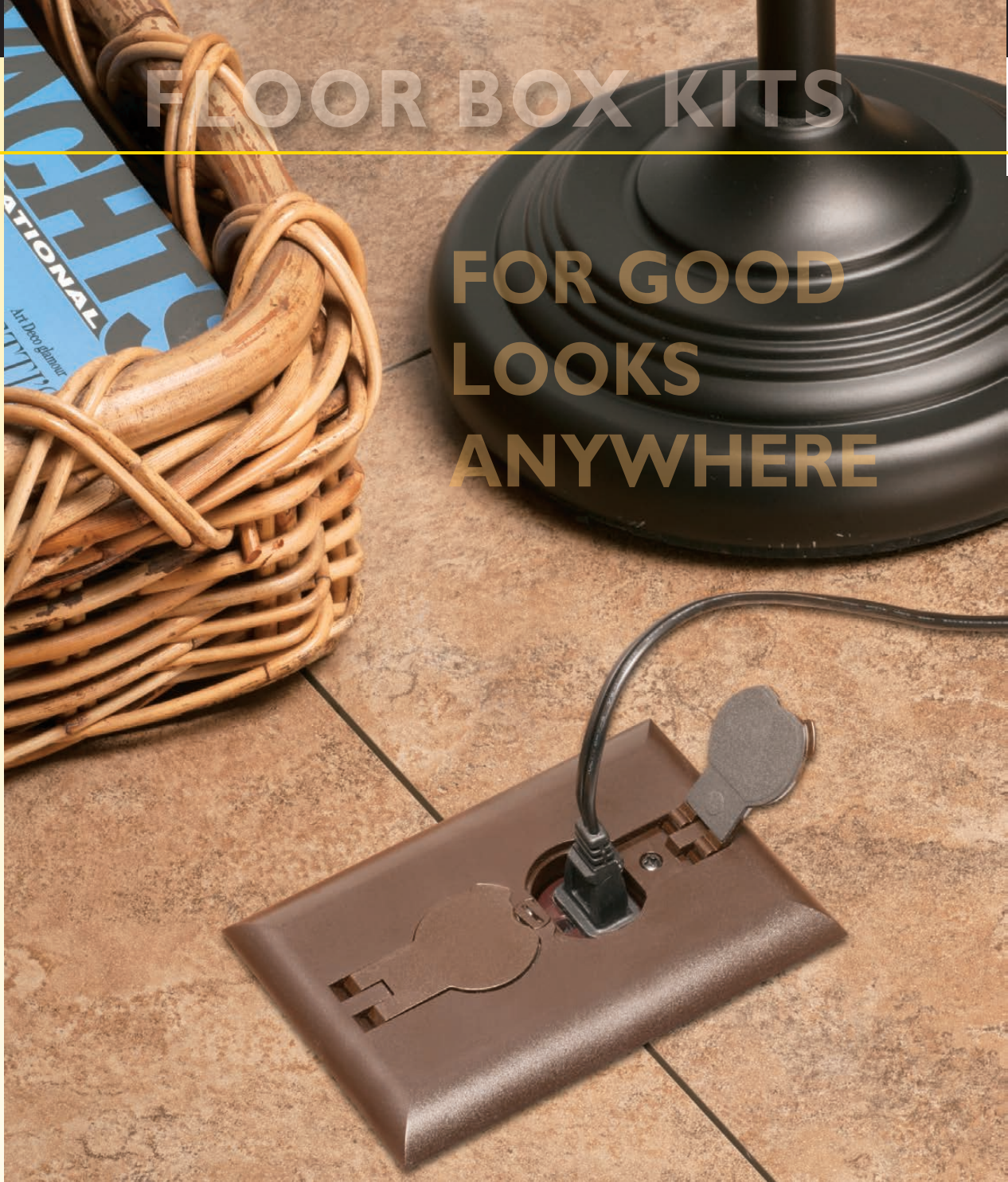

FLOOR
BOX KITS

and INTERCHANGEABLE FLOOR BOXES • COVERS • ACCESSORIES



Arlington

Distributed by



Non-metallic and

Metal Covers



PUT A RECEPTACLE IN THE FLOOR THE EASY WAY!

**FLOOR BOX KITS and
Boxes • Covers • Accessories**



NON-METALLIC BOXES THREE STYLES



FLUSH FIT

FOR NEW OR EXISTING FLOORS

Arlington's **UL Listed FLOOR BOX KITS** offer installers the low cost, *convenient* way to put a receptacle in the floor – with a box that installs flush with the floor.

We have a floor box for nearly any job site condition. There's one for new concrete pours, a box for existing floors – and an *adjustable* box that fits most finished floor heights up to 2". All are available with oversized non-metallic or metal covers. And all install flush with the floor surface

COVERS Our non-metallic boxes have gasketed covers that prevent water intrusion – with your choice of threaded plugs or flip lids that protect the receptacle when it's not in use. Best of all, they're oversized to hide miscut flooring!

Arlington's single-gang floor box kits are available with metal or non-metallic covers in a variety of colors and finishes.

Non-metallic in white, black, brown, light almond and **metal** in brass and nickel-plated brass.

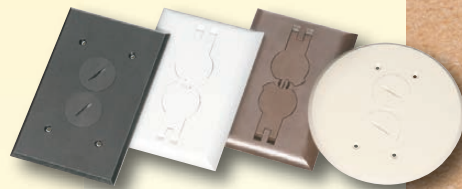

ON EXISTING FLOORS

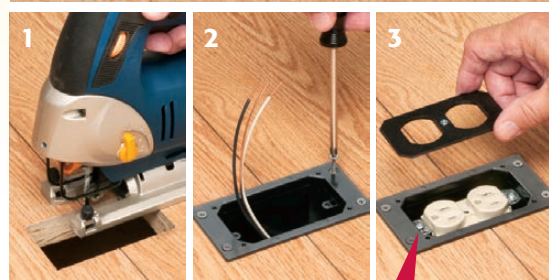
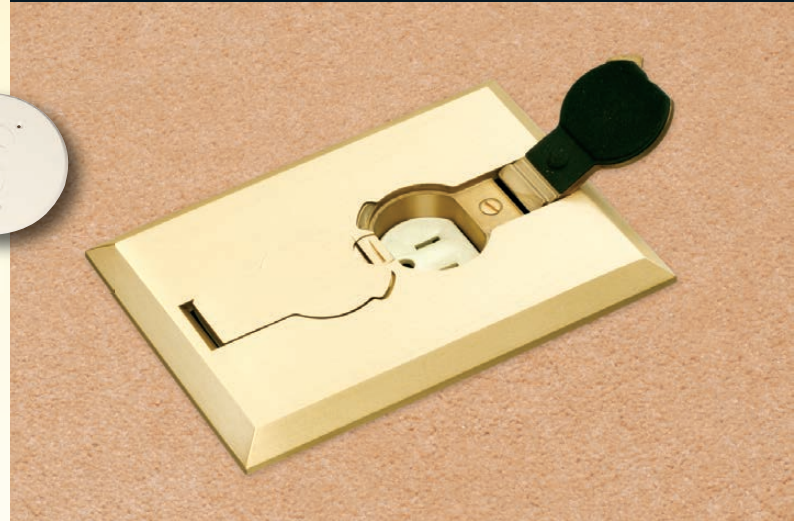

Easy to install in an Existing Floor...Cut the opening...Install

See pages 8-15 for INTERCHANGEABLE, COST-EFFECTIVE Single and Two-Gang Floor Box Kits, Boxes, Covers and Accessories.



View Video



FLBR101BR
Rectangular,
Brown Cover

ADJUSTS TO FINAL FLOOR HEIGHT



FOR FLOORS UP TO 2" THICK



FOR NEW CONCRETE POURS



Flip Lid
Cover Style



Supplied with 1/8", 1/4", 1/2" and 3/4" spacers to allow for increases in floor thickness; tile, wood, carpet, etc.

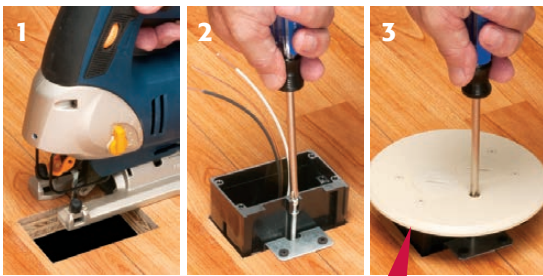

Adjustable boxes for varying floor heights

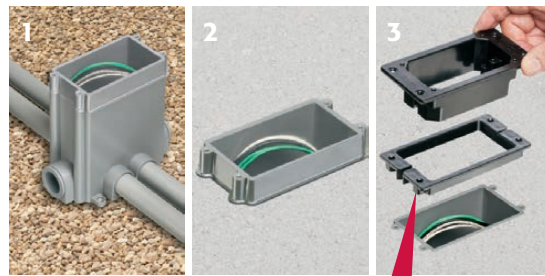

Supplied spacers allow for adjustment to final floor thickness

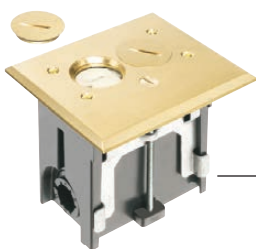

FLBA101MB
Rectangular,
Brass Cover

Adjustable Bracket
positions box
flush with floor



FLBCF101MB
Brass Cover
with Flip Lids

UL LISTED FLOOR BOX KITS

FOR EXISTING FLOORS

FOR EXISTING FLOORS

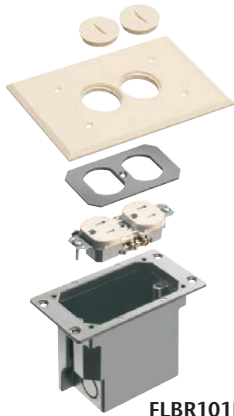

FLBR101LA

| CATALOG NUMBER | UPC/DCI/NAED MFG. #018997 | DESCRIPTION | COVER MATERIAL | COVER STYLE/SHAPE | COVER COLOR | UNIT PKG | STD PKG |
|----------------|---------------------------|---|---|--|--------------|----------|---------|
| FLBRF101W | 16253 | 20.0 cubic inch BOX FOR EXISTING FLOORS | Non-Metallic | RECTANGULAR with TWO FLIP LIDS | White | 1 | 4 |
| FLBRF101LA | 16252 | | Non-Metallic | | Light Almond | 1 | 4 |
| FLBRF101BR | 16251 | | Non-Metallic | | Brown | 1 | 4 |
| FLBRF101BL | 16250 | | Non-Metallic | | Black | 1 | 4 |
| FLBRF101MB | 16254 | | Flush-to-the-floor Installation. Put a receptacle where you need it...easy. | | Metal | Brass | 1 |
| FLBRF101NL | 16255 | | Metal | Nickel-plated brass | 1 | 4 | |
| FLBR101W | 04356 |  | Non-Metallic | RECTANGULAR with TWO THREADED PLUGS | White | 1 | 4 |
| FLBR101LA | 04357 | | Non-Metallic | | Light Almond | 1 | 4 |
| FLBR101BR | 04359 | | Non-Metallic | | Brown | 1 | 4 |
| FLBR101BL | 04358 | | Non-Metallic | | Black | 1 | 4 |
| FLBR101MB | 52263 | | Metal | | Brass | 1 | 4 |
| FLBR101NL | 52453 | | Metal | Nickel-plated brass | 1 | 4 | |

Includes: Floor Box, duplex receptacle, (1) NM94 connector, back plate on non-metallic covers, gasketed cover, (5) #6-32 cover plate screws and threaded plugs or flip lids.

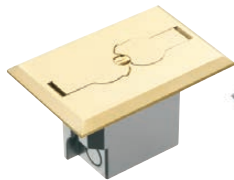

FLBRF101MB



FLBRF101W



FLBRF101BL

Not shown:

FLBRF101NL (Nickel-plated cover with flip lids)

FLBRF101BR (Non-metallic, brown cover with flip lids)



FLBRF101LA

INSTALLS FLUSH WITH FLOOR



FLBR101MB



FLBR101NL



FLBR101BL



FLBR101BR

Not shown:

FLBR101W (Non-metallic, white cover with threaded plugs)



View Video



UL LISTED FLOOR BOX KITS

**ADJUSTABLE...
FOR FLOORS
UP TO 2" H**

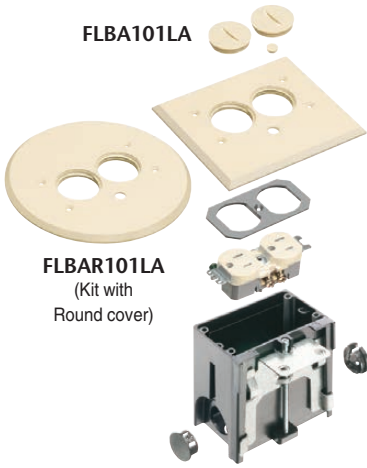

| CATALOG NUMBER | UPC/DCI/NAED MFG. #018997 | DESCRIPTION UL Listed Floor Box Kit | COVER MATERIAL | COVER STYLE/SHAPE | COVER COLOR | UNIT PKG | STD PKG |
|----------------|---------------------------|---|----------------|---------------------------|---------------------|----------|---------|
| FLBAF101W | 04340 | | Non-Metallic | | White | 1 | 4 |
| FLBAF101LA | 04341 | | Non-Metallic | RECTANGULAR | Light Almond | 1 | 4 |
| FLBAF101BR | 04343 | | Non-Metallic | with | Brown | 1 | 4 |
| FLBAF101BL | 04342 | | Non-Metallic | TWO FLIP LIDS | Black | 1 | 4 |
| FLBAF101MB | 13805 | | Metal | | Brass | 1 | 4 |
| FLBAF101NL | 13806 | 18.3 cubic inch ADJUSTABLE BOX | Metal | | Nickel-plated brass | 1 | 4 |
| FLBA101W | 04344 | Fits most finished floor heights up to 2" | Non-Metallic | RECTANGULAR | White | 1 | 4 |
| FLBA101LA | 04345 | | Non-Metallic | with | Light Almond | 1 | 4 |
| FLBA101BR | 04347 | | Non-Metallic | TWO THREADED PLUGS | Brown | 1 | 4 |
| FLBA101BL | 04346 | | Non-Metallic | | Black | 1 | 4 |
| FLBA101MB | 52259 | | Metal | | Brass | 1 | 4 |
| FLBA101NL | 52450 | | Metal | | Nickel-plated brass | 1 | 4 |
| FLBAR101W | 04348 | | Non-Metallic | ROUND | White | 1 | 4 |
| FLBAR101LA | 04349 | | Non-Metallic | with | Light Almond | 1 | 4 |
| FLBAR101BR | 04351 | | Non-Metallic | TWO THREADED PLUGS | Brown | 1 | 4 |
| FLBAR101BL | 04350 | | Non-Metallic | | Black | 1 | 4 |
| FLBAR101MB | 52261 | | Metal | | Brass | 1 | 4 |
| FLBAR101NL | 52451 | | Metal | | Nickel-plated brass | 1 | 4 |

Includes: Adjustable Floor Box, (1) tamper-resistant ("TR") duplex receptacle, (1) cover plate w/ gasket, flip lids or threaded plugs, (2) #6-32 x 1" long screws, (2) #6 drywall screws, (1) NM94 connector, (1) NM900 plug, (1) cap (covers adjustable screw hole in cover plate)

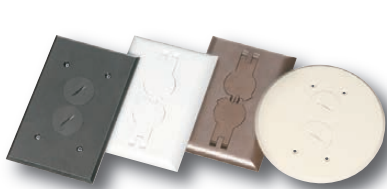

NON-METALLIC COVER COLORS



FLBA101W



FLBAR101BL



FLBA101MB



FLBA101NL

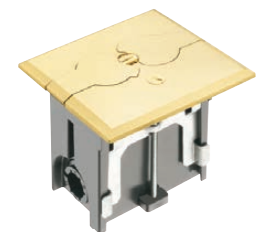
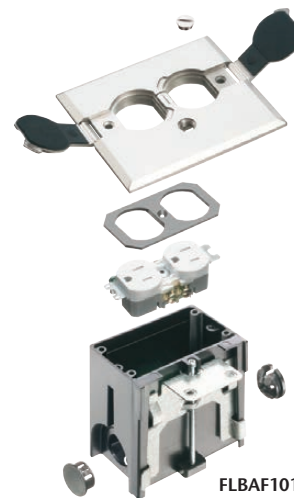
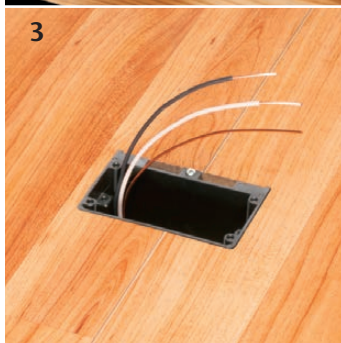
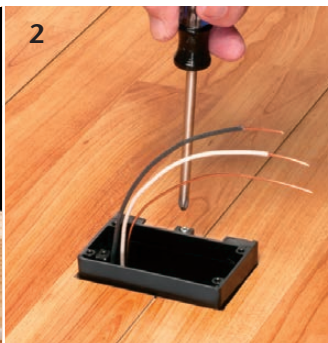

FLBAF101MB



UL LISTED FLOOR BOX KITS

FOR CONCRETE POURS



FOR NEW CONCRETE



FLBCF101BR



FLBC101BL

| CATALOG NUMBER | UPC/DCI/NAED MFG. #018997 | DESCRIPTION UL Listed Floor Box Kit | COVER MATERIAL | COVER STYLE/SHAPE | COVER COLOR | UNIT PKG | STD PKG |
|----------------|---------------------------|---|----------------|--|---------------------|----------|---------|
| FLBCF101W | 06950 | BOX FOR NEW CONCRETE Includes spacers for adjusting box to finished floor height  | Non-Metallic | RECTANGULAR with TWO FLIP LIDS | White | 1 | 1 |
| FLBCF101LA | 06951 | | Non-Metallic | | Light Almond | 1 | 1 |
| FLBCF101BR | 06952 | | Non-Metallic | | Brown | 1 | 1 |
| FLBCF101BL | 06953 | | Non-Metallic | | Black | 1 | 1 |
| FLBCF101MB | 52454 | | Metal | | Brass | 1 | 1 |
| FLBCF101NL | 52455 | | Metal | | Nickel-plated brass | 1 | 1 |
| FLBC101W | 04352 |  | Non-Metallic | RECTANGULAR with TWO THREADED PLUGS | White | 1 | 1 |
| FLBC101LA | 04353 | | Non-Metallic | | Light Almond | 1 | 1 |
| FLBC101BR | 04355 | | Non-Metallic | | Brown | 1 | 1 |
| FLBC101BL | 04354 | | Non-Metallic | | Black | 1 | 1 |
| FLBC101MB | 52265 | | Metal | | Brass | 1 | 1 |
| FLBC101NL | 52452 | | Metal | | Nickel-plated brass | 1 | 1 |

Includes: Concrete box, mud cover, (4) 3/4" plugs, (2) 1" plugs, (1) 1/8" spacer, (1) 1/4" spacer, (1) 1/2" spacer and (1) 3/4" spacer, mounting bracket, duplex receptacle, gasketed cover plate, (5) #6-32 x 1/2" long cover plate screws, (4) #8 x 5/8" long sheet metal screws, (4) #8 x 1-1/4" long sheet metal screws and threaded plugs or flip lids.

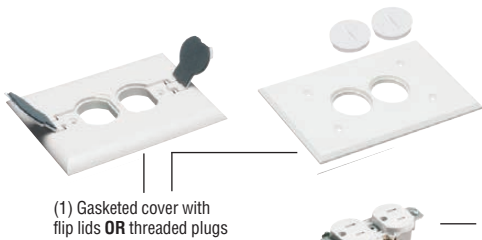

(1) Gasketed cover with flip lids **OR** threaded plugs



FLBC101NL



FLBC101MB

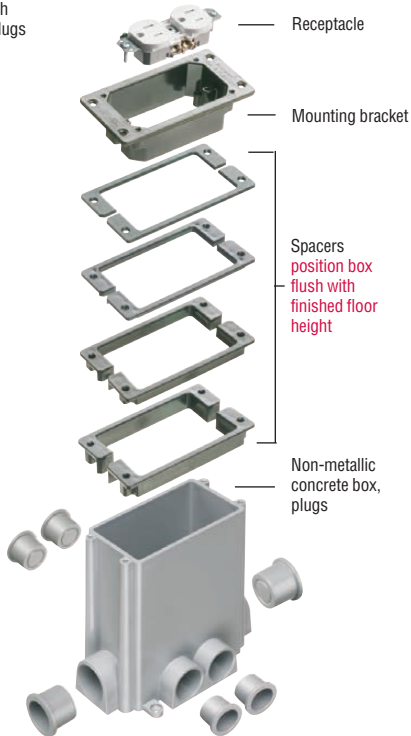

View Video



ROUGH-IN & TRIM KITS

FOR NEW CONCRETE

ROUGH-IN KIT

Non-metallic concrete box and plugs

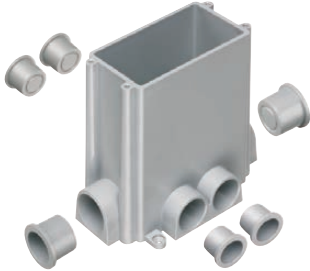

| CATALOG NUMBER | UPC/DCI/NAED MFG. #018997 | DESCRIPTION Rough-In Kit | BOX MATERIAL | COLOR | UNIT PKG | STD PKG |
|----------------|---------------------------|--|--------------|--------------|----------|---------|
| FLBC101RK | 13820 | Non-metallic concrete box, plugs and mud cover | Non-Metallic | Gray plastic | 1 | 1 |

Includes: Concrete box, (4) 3/4" plugs, (2) 1" plugs and mud cover (not shown)

TRIM KIT

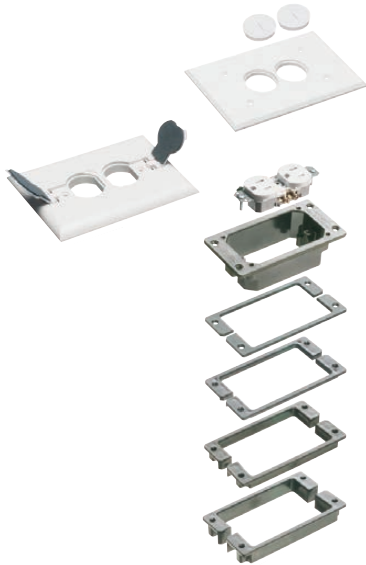

| CATALOG NUMBER | UPC/DCI/NAED MFG. #018997 | DESCRIPTION Trim Kit | COVER MATERIAL | COVER STYLE/SHAPE | COVER COLOR | UNIT PKG | STD PKG |
|----------------|---------------------------|--|----------------|--|---------------------|----------|---------|
| FLBCF101WTK | 13827 | | Non-Metallic | | White | 1 | 1 |
| FLBCF101LATK | 13828 | TRIM KIT | Non-Metallic | RECTANGULAR COVER with TWO FLIP LIDS | Light Almond | 1 | 1 |
| FLBCF101BRTK | 13829 | Includes (4) spacers, mounting bracket, receptacle, (1) gasketed cover with flip lids | Non-Metallic | | Brown | 1 | 1 |
| FLBCF101BLTK | 13830 | | Non-Metallic | | Black | 1 | 1 |
| FLBCF101MBTK | 13831 | | Metal | | Brass | 1 | 1 |
| FLBCF101NLTK | 13832 | | Metal | | Nickel-plated brass | 1 | 1 |
| FLBC101WTK | 13821 | TRIM KIT | Non-Metallic | RECTANGULAR COVER with TWO THREADED PLUGS | White | 1 | 1 |
| FLBC101LATK | 13822 | Includes (4) spacers, mounting bracket, receptacle, (1) gasketed cover with threaded plugs | Non-Metallic | | Light Almond | 1 | 1 |
| FLBC101BRTK | 13823 | | Non-Metallic | | Brown | 1 | 1 |
| FLBC101BLTK | 13824 | | Non-Metallic | | Black | 1 | 1 |
| FLBC101MBTK | 13825 | | Metal | | Brass | 1 | 1 |
| FLBC101NLTK | 13826 | | Metal | | Nickel-plated brass | 1 | 1 |

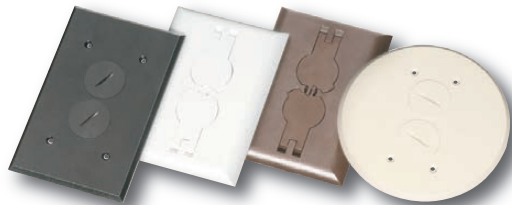

NON-METALLIC COVER COLORS



BRASS & NICKEL-PLATED BRASS METAL COVERS

INTERCHANGEABLE

FLOOR BOX KITS, COVERS, ACCESSORIES

NEW & EXIST

FOR NEW OR EXISTING FLOORS

Arlington's cost-effective **FLOOR BOX KITS** offer installers the low cost, *convenient* way to install a receptacle *flush with the floor* wherever your customer needs one.

This new series of floor box kits, covers and accessories is designed for installation convenience in new and existing floors, and new concrete pours (Page 9) – as well as interchangeability with a variety of other manufacturers' floor boxes.

Available with a **steel** box and a gasketed brass or nickel-plated brass cover to prevent water intrusion, the cover comes with threaded plugs or flip lids to protect the receptacle when it's not in use.

With a variety of floor box kits and individual metal covers and accessories, Arlington offers just about any option you could possibly need...

- Single and two-gang floor box kits...and a *combination* box kit with an installed divider for power and low voltage in the same box.
- Rectangular or square metal covers with flip lids or threaded plugs...also sold separately.



Covers with threaded plugs for two-gang box



Cover with flip lids for single gang (or two-gang) box

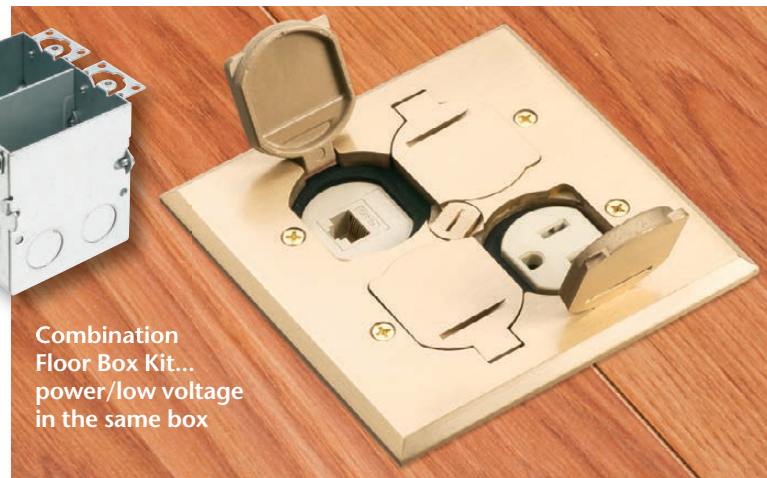

Combination Floor Box Kit... power/low voltage in the same box



COVERS TO FIT OTHER MANUFACTURERS' BOXES FOR GOOD LOOKS ANYWHERE!



Arlington

ING FLOORS and NEW CONCRETE

Arlington's FLOOR BOX KITS and COVERS **FOR NEW CONCRETE** offer flexibility and convenience.

Made of heavy-duty plastic, our 4.5" non-metallic **concrete box**

is a universal "fits all" size, that accommodates our 6" round covers as well as *most other round covers on the market.*

Our versatile concrete box **covers** are available with flip lids or threaded plugs – in brass or nickel-plated brass. They deliver easier-than-ever installation of receptacles so they'll look great wherever they're installed!

A selection of leveling rings and adapters allows our covers to fit our boxes *and* most other manufacturers' concrete boxes.

For the fastest installation, our trapdoor covers ship *ready to use* with a pre-installed gasket and decorator-style receptacle.



Flip Lid Cover for concrete box



Nickel-plated
FLBT6615NL
(closed)



FLBT6615NL
(open)



Brass Trapdoor style
FLBT6615MB
(open and back)

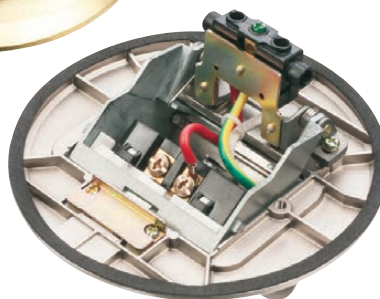

COVERS WITH FLIP LIDS

FLB5331NL
Single-gang with nickel cover

(exploded views)

FLB5551MB
Two-gang with brass cover

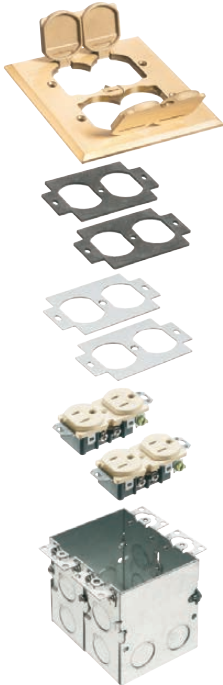
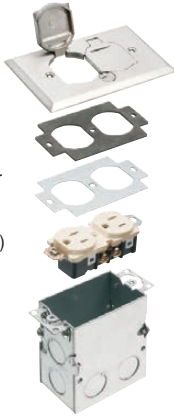

| CATALOG NUMBER | UPC/DCI/NAED MFG. #018997 | DESCRIPTION COVERS WITH FLIP LIDS | COVER SIZE & STYLE | COVER SHAPE | UNIT PKG | STD PKG |
|---|---------------------------|--|-----------------------------------|-------------|----------|---------|
| FLOOR BOX KITS • with STEEL BOX | | | | | | |
| FLB5331MB | 22019 | Single-gang steel box, gaskets, (1) duplex receptacle, gasketed cover, mounting screws | Brass with Two Flip Lids | ■ | 1 | 4 |
| FLB5331NL | 22020 | Single-gang steel box, gaskets, (1) duplex receptacle, gasketed cover, mounting screws | Nickel-plated with Two Flip Lids | ■ | 1 | 4 |
| FLOOR BOX KITS • with STEEL BOX | | | | | | |
| FLB5551MB | 22038 | Two-gang steel box, gaskets, (2) duplex receptacles, gasketed cover, mounting screws | Brass with Four Flip Lids | ■ | 1 | 4 |
| FLB5551NL | 22039 | Two-gang steel box, gaskets, (2) duplex receptacles, gasketed cover, mounting screws | Nickel-plated w/ Four Flip Lids | ■ | 1 | 4 |
| METAL GASKETED COVERS with receptacle | | | | | | |
| FLB5330MB | 22017 | Brass Cover | Single-gang with Two Flip Lids | ■ | 1 | 10 |
| FLB5330NL | 22018 | Nickel-plated Cover | Single-gang with Two Flip Lids | ■ | 1 | 10 |
| FLB5550MB | 22036 | Brass Cover | Two-gang with Four Flip Lids | ■ | 1 | 10 |
| FLB5550NL | 22037 | Nickel-plated Cover | Two-gang with Four Flip Lids | ■ | 1 | 10 |
| FLOOR BOX KITS • with TWO-GANG STEEL COMBO BOX | | | | | | |
| FLB5552MB | 22050 | Two-gang steel box with installed low voltage divider, gaskets, (1) duplex receptacle, (1) low voltage duplex plate, mounting screws | Brass with Four Flip Lids | ■ | 1 | 4 |
| FLB5552NL | 22051 | Two-gang steel box with installed low voltage divider, gaskets, (1) duplex receptacle, (1) low voltage duplex plate, mounting screws | Nickel-plated with Four Flip Lids | ■ | 1 | 4 |

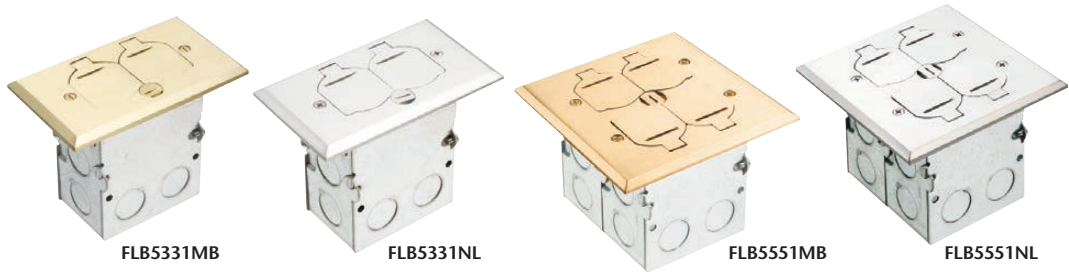

SINGLE & TWO-GANG FLOOR BOX KITS

COMBINATION POWER/LOW VOLTAGE FLOOR BOX KIT



FLB5552MB
Power/Low Voltage Combo Box

FLB5552NL combo box with nickel-plated cover



Divider separates power & low voltage

FLB5552MB



Arlington

| Carlson • T&B | Hubbell | Lew | WireMold • P&S |
|------------------------------------|-----------------------------------|---------------|---------------------------------|
| 71W-DS | B2481 + S3825 (needs receptacle) | SWB-2-LR | 880W1818TCAL (needs receptacle) |
| 71W-DS-N | B2481 + SA3825 (needs receptacle) | SWB-2-LRA | 880W1818TCAL (needs receptacle) |
| 62W + (2) 64-DS (needs receptacle) | B2482 + SB3082 + (2) S3925 | SWB-4-PQ-LR | 880W2827B (needs receptacle) |
| 62W + (2) 64-AL (needs receptacle) | B2482 + SB3082 + (2) SA3825 | SWB-4-PQ-LR | 880W2827B (needs receptacle) |
| P-64-DS | S3825 | RRP-2-LRR | 828R |
| P-64-DS-AL | SA3825 | RRP-2-LR-AR | 828R-TCAL |
| (2) 64-DS | SB3084 + S3825 | RRP-4-BP-LR | (2) 828R |
| (2) 64-DS-AL | SB3082 + (2) SA3825 | RRP-4-PQ-LR-A | (2) 828R-TCAL |
| ---- | ---- | ---- | ---- |
| ---- | ---- | ---- | ---- |

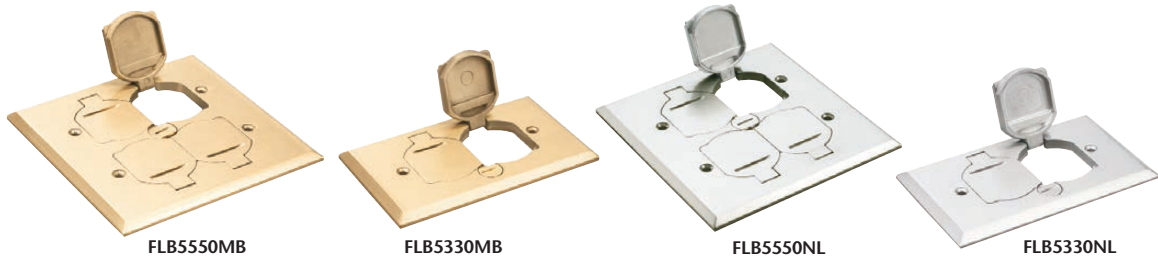

ARLINGTON'S METAL GASKETED COVERS with FLIP LIDS

Arlington's steel floor outlet boxes are compatible with our metal floor box covers on pages 10 and 12. Features include: installed grounding screw, adjustable mounting ears and multiple 1/2" knockouts.

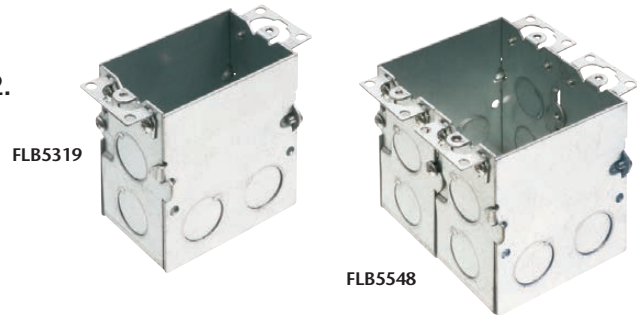

STEEL OUTLET BOXES FOR NEW OR RETROFIT CONSTRUCTION

| CATALOG NUMBER | UPC/DCI/NAED MFG. #018997 | DESCRIPTION | CUBIC INCHES | # OF KNOCKOUTS | UNIT PKG | STD PKG |
|----------------|---------------------------|---|--------------|----------------|----------|---------|
| FLB5319 | 22060 | Single-gang Steel Floor Outlet Box | 18.0 | 9 | 1 | 10 |
| FLB5548 | 22061 | Two-gang Steel Floor Outlet Box | 36.0 | 14 | 1 | 10 |
| FLB5549 | 22062 | Two-gang Steel Floor Combination Box with installed (removable) divider for power/low voltage | 36.0 | 14 | 1 | 10 |



COVERS WITH THREADED PLUGS



FLB5541MB
Floor Box Kit
(exploded view)

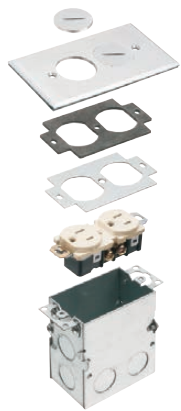

FLB5321NL
(exploded view)

| CATALOG NUMBER | UPC/DCI/NAED MFG. #018997 | DESCRIPTION COVERS WITH FLIP LIDS | COVER SIZE & STYLE | COVER SHAPE | UNIT PKG | STD PKG |
|---|---------------------------|---|--|-------------|----------|---------|
| FLOOR BOX KIT • with STEEL BOX | | | | | | |
| FLB5321MB | 22015 | Single-gang steel box, gaskets, receptacle, gasketed cover, mounting screws | Brass with Two Threaded Plugs | ■ | 1 | 4 |
| FLB5321NL | 22016 | | Nickel-plated with Two Threaded Plugs | ■ | 1 | 4 |
| FLB5541MB | 22034 | Two-gang steel box, gaskets, receptacles, gasketed cover, mounting screws | Brass with Four Threaded Plugs | ■ | 1 | 4 |
| FLB5541NL | 22035 | | Nickel-plated with Four Threaded Plugs | ■ | 1 | 4 |
| METAL GASKETED COVER with receptacle | | | | | | |
| FLB5320MB | 22013 | Brass Cover | Single-gang with Two Threaded Plugs | ■ | 1 | 10 |
| FLB5320NL | 22014 | Nickel-plated Cover | Single-gang with Two Threaded Plugs | ■ | 1 | 10 |
| FLB5540MB | 22005 | Brass Cover | Two-gang with Four Threaded Plugs | ■ | 1 | 10 |
| FLB5540NL | 22033 | Nickel-plated Cover | Two-gang with Four Threaded Plugs | ■ | 1 | 10 |



FLB5321MB



FLB5321NL

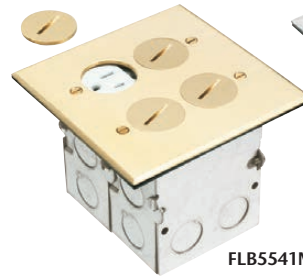

FLB5541MB



FLB5541NL

SINGLE & TWO-GANG FLOOR BOX KITS



FLB5541NL



Arlington

| Carlson • T&B | Hubbell | Lew | WireMold • P&S |
|--------------------------------------|-----------------------------------|------------|----------------------------------|
| 61W + P-64-DU (needs receptacle) | B2481 + S3625 (needs receptacle) | SWB-2 | 880W1+828SPTC (needs receptacle) |
| 61W + P-64-DU-AL (needs receptacle) | B2481 + SA3625 (needs receptacle) | SWB-2-NS | (2) 828SPTC |
| 62W + (2) P-64-DU (needs receptacle) | B2482 + SB3084W + SA3625 | SWB-4-PQ | 880W2 |
| 62W + (2) P-64-DU-AL | B2482 + SA3084 + (2)SA3625 | SWB-4-PQ-A | 880W2 + (2) 828SPTC |
| P-64-DU | S3625 | RRP-2-BR | 828SPTC |
| P-64-DU-AL | SA3625 | RRP-2-NS | ----- |
| (2) P-64-DU | SB3084W + (2) SA3625 | RRP-4-BP | 880W1+(2) 828SPTC |
| (2) P-64-DU-AL | SA3084W + (2) SA3625 | RRP-4-BP-A | (2) 828SPTC |

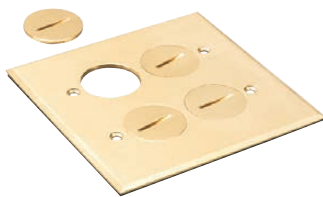

FLB5540MB



FLB5320MB



FLB5540NL



FLB5320NL

ARLINGTON'S METAL GASKETED COVERS with THREADED PLUGS

Arlington's single and two-gang steel floor outlet boxes are compatible with our metal floor box covers on pages 10 and 12.

Features include: installed grounding screw, adjustable mounting ears and multiple 1/2" knockouts.



FLB5319

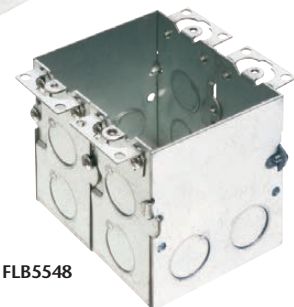

FLB5548

STEEL OUTLET BOXES FOR NEW OR RETROFIT CONSTRUCTION

| CATALOG NUMBER | UPC/DCI/NAED MFG. #018997 | DESCRIPTION | CUBIC INCHES | # OF KNOCKOUTS | UNIT PKG | STD PKG |
|----------------|---------------------------|------------------------------------|--------------|----------------|----------|---------|
| FLB5319 | 22060 | Single-gang Steel Floor Outlet Box | 18.0 | 9 | 1 | 10 |
| FLB5548 | 22061 | Two-gang Steel Floor Outlet Box | 36.0 | 14 | 1 | 10 |

FOR NEW CONCRETE POURS



FLBC4500
(Mud cover in place)

| CATALOG NUMBER | UPC/DCI/NAED MFG. #018997 | DESCRIPTION | NOTES | UNIT PKG | STD PKG |
|-------------------|---------------------------|--|-------------------------------|----------|---------|
| FLBC4500 | 22010 | 4.5" Non-metallic Round Box for Concrete Pours (conduit plugs, mud cover, voltage divider) | | 1 | 5 |
| FLB6230MB | 22025 | Cover Kit 6" Round, Brass w two flip lids | *hole pattern fits FLBC4500LR | 1 | 10 |
| FLB6230NL | 22026 | Cover Kit 6" Round, Nickel-plated w two flip lids | *hole pattern fits FLBC4500LR | 1 | 10 |
| FLB6220MB | 22021 | Cover Kit 6" Round, Brass w two threaded plugs | *hole pattern fits FLBC4500LR | 1 | 10 |
| FLB6220NL | 22022 | Cover Kit 6" Round, Nickel-plated w two threaded plugs | *hole pattern fits FLBC4500LR | 1 | 10 |
| FLBC4500LR | 22011 | Leveling Ring for Arlington FLBC4500 & above round covers (has bosses for cover mounting) | | 1 | 10 |
| FLBT6615MB | 22030 | Trapdoor Cover Round, Brass. Pre-mounted gasket & decorator-style 15A receptacle | | 1 | 10 |
| FLBT6615NL | 22031 | Trapdoor Cover Round, Nickel-plated. Pre-mounted gasket & decorator-style 15A receptacle | | 1 | 10 |
| FLBT6615LR | 22029 | Leveling Ring for Arlington FLBC4500 box w FLBT6615 trapdoor style cover | | 1 | 10 |
| FLBC4500AR | 22004 | Oversized Adapter Ring for 5" diameter concrete boxes | | 1 | 10 |
| FLBC4500Y | 22012 | "Y" Adapter - Provides (2) 1" openings for conduit entering 1" hub | | 1 | 10 |

NON-METALLIC CONCRETE BOX

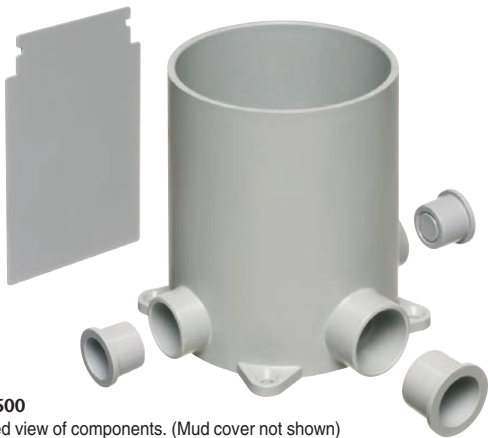

FLBC4500
Exploded view of components. (Mud cover not shown)

COVER KITS with FLIP LIDS

FLB6230MB
Brass cover

Includes cover with flip lids, gaskets, receptacle.

Also available with Nickel-plated cover **FLB6230NL** (not shown)



COVER KITS with THREADED PLUGS

FLB6220MB
Brass cover

Includes cover with threaded plugs, gaskets, receptacle.

FLB6220NL
Nickel-plated cover

(NOT SHOWN)

LEVELING RING

Hole pattern fits above round covers:
FLB6230MB
FLB6230NL
FLB6220MB
FLB6220NL

FLBC4500LR

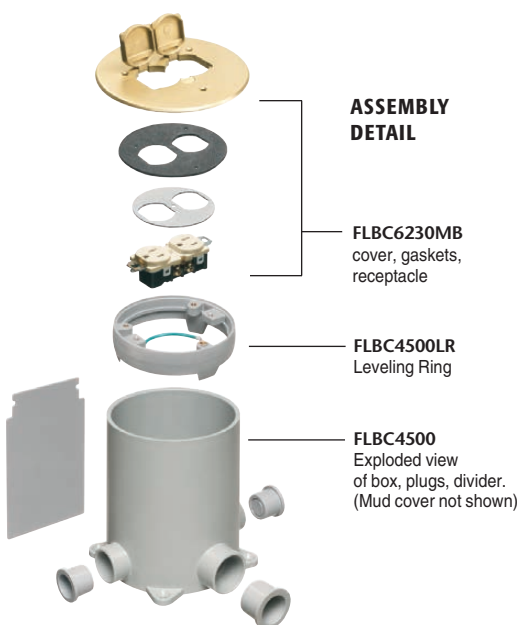

| Carlson • T&B | Hubbell | Lew | WireMold • P&S |
|-----------------|---------------|----------|------------------------|
| E971FB, 68P | PFB1 | FB | 881 E971FB, 68P |
| E97BR2, P60DS | S3925 + S3082 | TCP-2-LR | 895T E97BR2, P60DS |
| E97SS2, P60CACP | ----- | TCP-LR-A | 895 E97SS2, P60CACP |
| P-60-DUP-60-CP | S3725 + S3082 | TCP-2 | 895SP P-60-DUP-60-CP |
| ----- | ----- | ----- | ----- |
| E97ABR2, 68-PAR | PFBA1 | LRA | 881ADP E97ABR2, 68-PAR |
| ----- | ----- | PUFP-BD | ----- |
| ----- | ----- | PUFF-SD | ----- |
| ----- | ----- | PUFF-LRA | ----- |
| ----- | ----- | LRA-HT | ----- |
| E972Y | PFBYA1 | Y-CONN | N/A E972Y |

ARLINGTON'S TRAPDOOR COVERS & LEVELING RING



FLBT6615MB
Trapdoor cover
(open & closed)



FLBT6615NL
Trapdoor cover



FLBT6615LR
Leveling Ring
for trapdoor covers



FLBT6615MB
Trapdoor cover
on **FLBC4500**
Concrete box



FLBT6615NL

ARLINGTON'S ADAPTERS



FLBC4500AR
Oversized
Adapter Ring



FLBC4500Y
"Y" Adapter



FLOOR BOX KITS

FOR GOOD
LOOKS
ANYWHERE

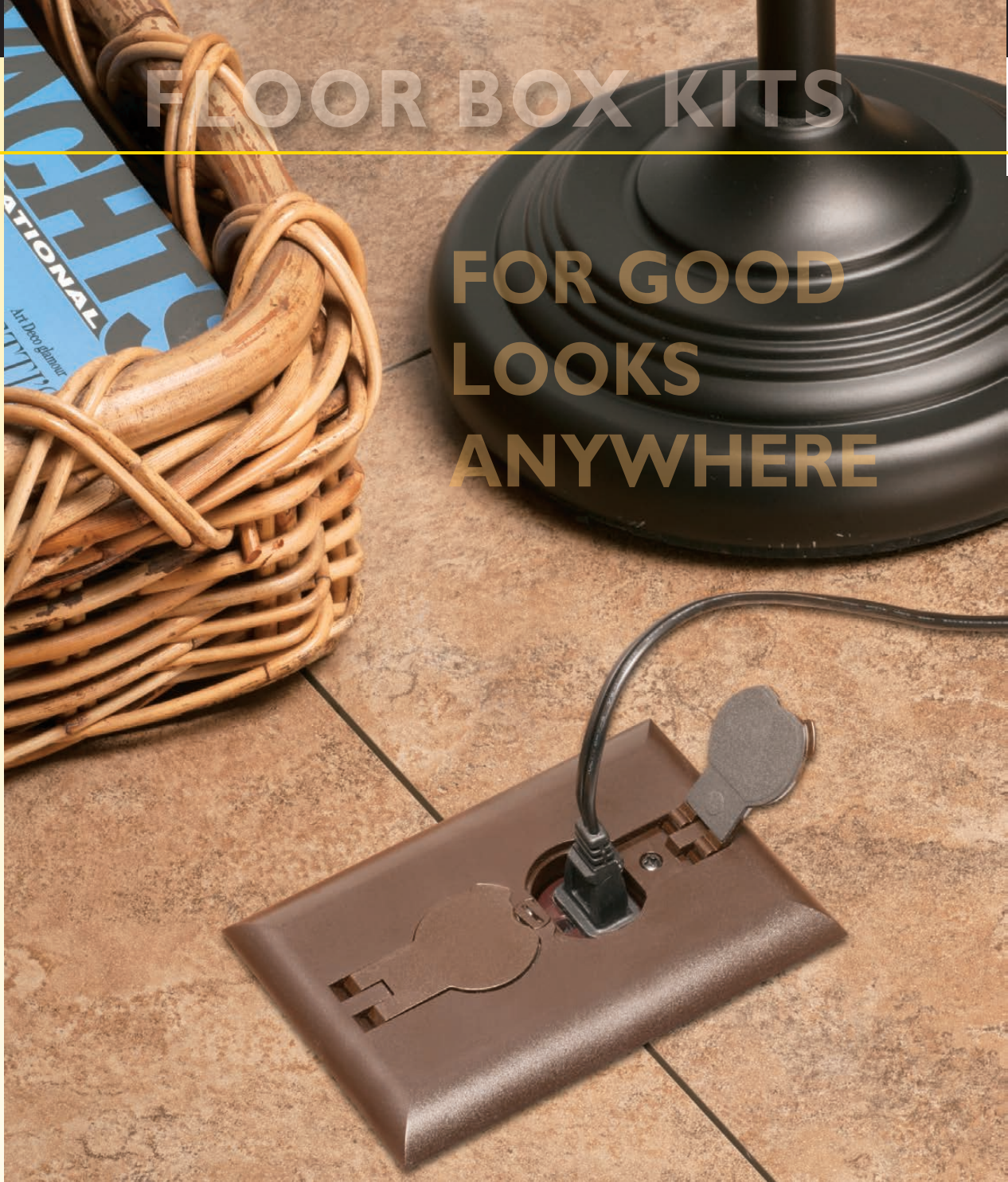

FLOOR
BOX KITS

and INTERCHANGEABLE FLOOR BOXES • COVERS • ACCESSORIES



Arlington

Distributed by