

NEW!
more on
reverse

IN BOX® Floor Box Kit with Recessed Wiring Device

For Existing Floors • TWO Low Voltage Ports • Listed Receptacle

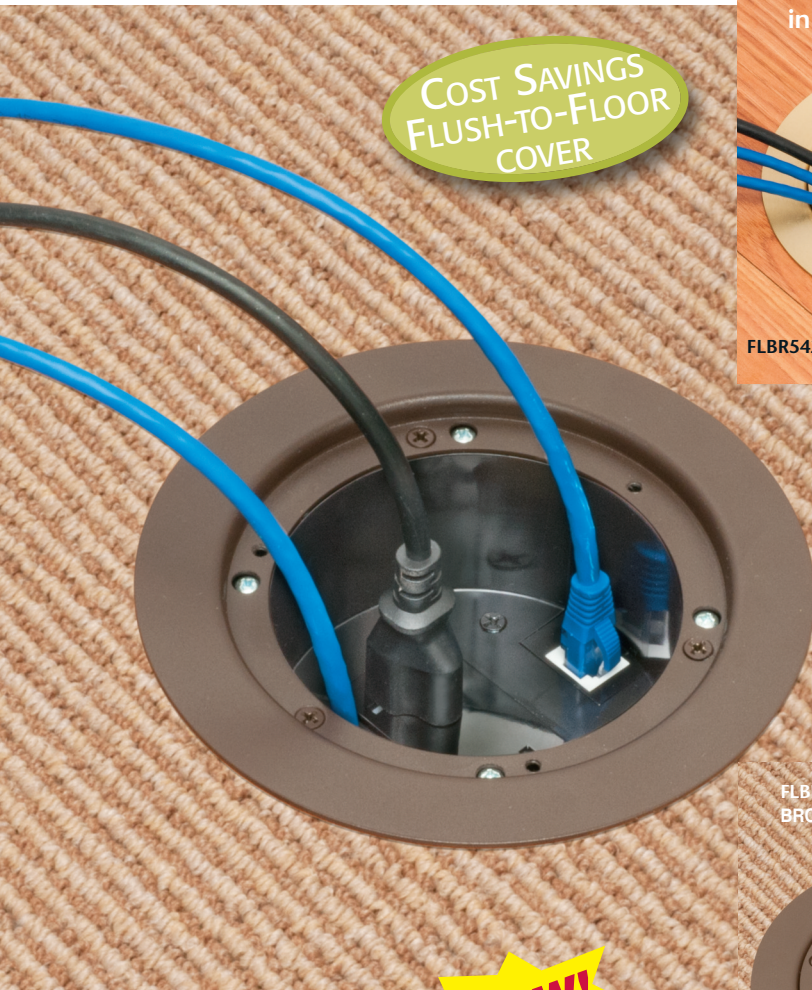

**ULTRA-THIN
Stamped
Steel Flange**

NEW!

**RECESSED FLOOR BOX
FLBR5420 SERIES**

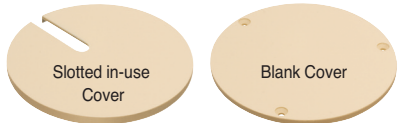

**FLBR5420LA
LIGHT ALMOND**



Low Voltage
Keystone Holder
Inserts (Installed)

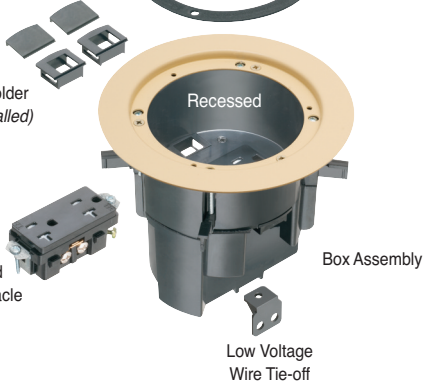

Patented



Arlington's FLBR5420 series RECESSED **FLOOR BOX KITS** offer great new features, like *two* low voltage openings, an ultra-thin stamped steel flange, and flush-to-the-floor in-use and blank covers. Here's the solution for cost-savings and easy installation of a receptacle and low voltage connections in an *existing*, hard surface floor.

Because the flange is ultra thin and the **wiring device is recessed** these floor boxes reduce the trip hazard caused by plugs protruding from the box.

You can also have power and **now TWO** low voltage openings, without the need for a divider, in the same box. That's convenience!

Installation is quick and easy with a 5" hole saw. Four mounting wing screws attach the 24.5 cubic inch box securely to the floor.

- cULus Listed 20A tamper-resistant decorator-style receptacle.
- Covers: **SIX finishes/colors**
Metal in brass-plated, nickel-plated and antique bronze-plated zinc.



And **powder-coated diecast zinc** in black, brown and light almond.



Arlington®

1 Stauffer Industrial Park
Scranton, PA 18517
800/233.4717
Fax 570/562.0646
www.aifittings.com

IN BOX[®] Floor Box Kit with Recessed Wiring Device

For Existing Wood, Tile or Hard Surface Floors



PLATED ZINC COVERS • PLATED STEEL FLANGE

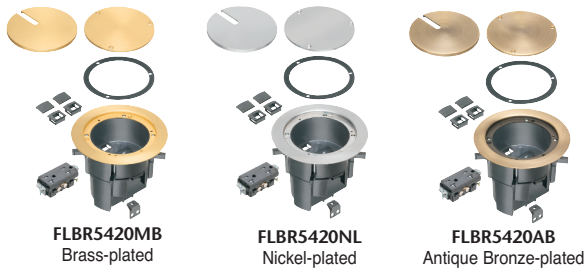

CATALOG NUMBER	UPC/DCI/NAED MFG. #018997	DESCRIPTION FLOOR BOX KIT FOR EXISTING FLOORS FINISH/COLOR, COVER STYLE	UNIT/STD PKG
----------------	---------------------------	---	--------------

FLOOR BOX KIT with PLATED DIECAST ZINC BLANK COVER and IN-USE SLOTTED COVER • PLATED STEEL FLANGE			
FLBR5420MB	21191	Brass-plated cover and flange, Black Decorator Style Receptacle	1
FLBR5420NL	21192	Nickel-plated cover and flange, Black Decorator Style Receptacle	1
FLBR5420AB	21269	Antique Bronze-plated cover and flange, Black Decorator Style Receptacle	1

Add suffix "GC" to catalog number when ordering in Canada. Example: FLBR5420ABGC

FLBR5420 KITS INCLUDE
 24.5 cu. inch non-metallic recessed box, cULus Listed, tamper resistant 20A decorator-style receptacle, (2) installed low voltage keystone holder inserts, (2) blank inserts, blank cover w/ gasket, in-use slotted plug cover, (3) #8x5/8" flat head screws, (1) NM cable connector, (2) low voltage tie-off brackets, (2) #8x1/2" sheet metal screws

POWDER-COATED ZINC COVERS • POWDER-COATED STEEL FLANGE

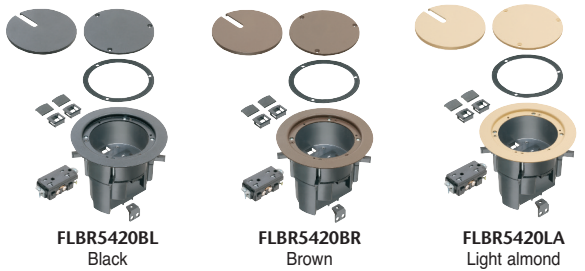

FLOOR BOX KIT with POWDER-COATED DIECAST ZINC BLANK COVER and IN-USE SLOTTED COVER • POWDER-COATED STEEL FLANGE			
FLBR5420BL	21266	Black cover and flange, Black Decorator Style Receptacle	1
FLBR5420BR	21267	Brown cover and flange, Black Decorator Style Receptacle	1
FLBR5420LA	21268	Light Almond cover and flange, Black Decorator Style Receptacle	1

Add suffix "GC" to catalog number when ordering in Canada. Example: FLBR5420LAGC



1 Determine location for the floor box installation (avoid structural framing members). Use a hole saw, to cut a 5" diameter hole through flooring and subfloor.

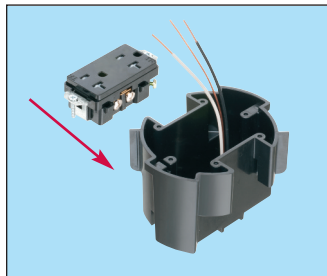

2 Pull non-metallic cable. Install in box using supplied NM94 cable connector. Wire receptacle and install in box.



3 Install (4) cover plate screws to secure box to floor flange assembly. Install low voltage devices into pre-installed LV keystone holder if desired (or use keystone blank inserts).



4 Low voltage tie-off brackets may be installed to back of box with supplied #6 x 1/2" screws. Use cable tie (not supplied) to attach low voltage cables if desired.



5 For wood, tile, or any hard surface floors, add caulking as required under flange to seal off at floor.



6 Place FLBR5420 Floor Box into hole. Orient the box to suit installation. Tighten four wing screws to secure box to the floor.

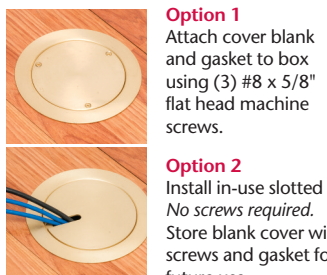

FLBR5420MB

Option 1
 Attach cover blank and gasket to box using (3) #8 x 5/8" flat head machine screws.

Option 2
 Install in-use slotted cover. No screws required. Store blank cover with screws and gasket for future use.

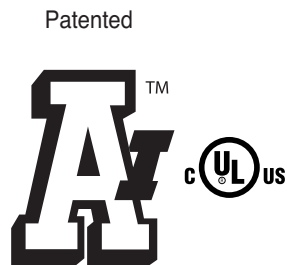

Arlington[®]

1 Stauffer Industrial Park
 Scranton, PA 18517
 800/233.4717
 Fax 570/562.0646
 www.aifittings.com

Made in USA

Distributed by