

FS and FD Cast Hub Device Boxes

UNILETS® for use with Threaded Rigid Conduit and IMC. All Device Boxes have Ridge Top Construction. Furnished with Internal Ground Screw.

Applications

- Accommodate wiring devices such as switches and receptacles.
- Provide excellent service in areas where boxes are subject to rough usage.
- Serve as pull boxes for conductors.
- Permit access to conductors for maintenance.
- Provide openings for making splices.
- Allow connections for branch conduit runs.
- Blank bodies for special conduit entrance arrangements.

Features

- Corrosion-resistant — ideal for indoor and outdoor installations.
- Weatherproof, raintight and dust-tight when used with cast gasketed covers.
- FS and FD boxes take standard flush wiring devices.
- FD boxes take devices exceeding 1.63 in/41.4 mm in depth under fastening ears.
- Malleable iron for high tensile strength and ductility — provides greater resistance to impact and shock.
- Both malleable iron and aluminum boxes have ridge top construction for positive cover/gasket/box fit.
- Accurately tapped, tapered threads for tight, rigid joints, ground continuity.
- Complete selection of covers, receptacles, plugs, gaskets and accessories.
- Covers have captive stainless steel screws to speed installation, prevents loss of screws.
- Internal grounding screws standard.
- Available in single, two and three gang and tandem.
- Smooth, rounded integral bushing in each hub protects conductor insulation.

Standard Materials

- Boxes: malleable iron or copperfree (4/10 of 1% max.) aluminum
- Covers: malleable iron, steel, or copperfree (4/10 of 1% max.) aluminum
- Screws: stainless steel
- Gaskets: neoprene

Standard Finishes

- Malleable iron boxes and covers: triple-coat — (1) zinc electroplate, (2) chromate, and (3) epoxy powder coat
- Aluminum boxes and covers: epoxy powder coat
- Steel covers: zinc electroplate

Certifications and Compliances

- UL Standard: 514A
- UL Listed: E2527
- CSA Standard: C22.2 No. 18.1
- CSA Certified: 001472
- NEMA Standard: FB-1

Options

- PVC coating available on select bodies and covers. Add suffix **-PVC** to catalog number.



Illustrated Features



Gasket is designed so that it wraps around ridge top of Appleton aluminum or malleable iron device box. Result is a positive seal against moisture.



Gasket construction. Cover tightens on largest perimeter of gasket and fits snugly against portion of gasket that wraps around ridge top of box.

FS and FD Single Gang Cast Hub Device Boxes

UNILETS® for use with Threaded Rigid Metal Conduit and IMC. Furnished with Internal Ground Screw.

FS Box (Shallow) 2.00" deep, FD Box (Deep) 2.69" deep					
	Type	Depth	Hub Size (Inches)	Catalog Number	
				Malleable Iron Ridge Top	Aluminum Ridge Top
	FS	Shallow	1/2	FS-1-50 *	FS-1-50-A *
			3/4	FS-1-75 *	FS-1-75-A *
			1	FS-1-100 *	FS-1-100-A *
	FD	Deep	1/2	FD-1-50 *	FD-1-50-A *
			3/4	FD-1-75 *	FD-1-75-A *
			1	FD-1-100 *	FD-1-100-A *
	FSC	Shallow	1/2	FSC-1-50 *	FSC-1-50-A *
			3/4	FSC-1-75 *	FSC-1-75-A *
			1	FSC-1-100 *	FSC-1-100-A *
	FDC	Deep	1/2	FDC-1-50 *	FDC-1-50-A *
			3/4	FDC-1-75 *	FDC-1-75-A *
			1	FDC-1-100 *	FDC-1-100-A *
	FSS	Shallow	1/2	FSS-1-50	FSS-1-50-A
			3/4	FSS-1-75	FSS-1-75-A
			1	FSS-1-100	FSS-1-100-A
	FDS	Deep	1/2	FDS-1-50	FDS-1-50-A
			3/4	FDS-1-75	FDS-1-75-A
			1	FDS-1-100	FDS-1-100-A
	FSLA	Shallow	1/2	FSLA-1-50	—

Fittings



FITTINGS: CAST DEVICE BOXES

* PVC coating available on select bodies. Add suffix **-PVC** to catalog number.

FS and FD Single Gang Cast Hub Device Boxes

UNILETS® for use with Threaded Rigid Metal Conduit and IMC. FS Box 2.00" Deep, FD Box 2.69" Deep. Furnished with Internal Ground Screw.

FS Box (Shallow) 2.00" deep, FD Box (Deep) 2.69" deep

	Type	Depth	Hub Size (Inches)	Catalog Number	
				Malleable Iron Ridge Top	Aluminum Ridge Top
	FSCA	Shallow	1/2	FSCA-1-50	—
			3/4	FSCA-1-75	—
	FSCC	Shallow	1/2	FSCC-1-50	—
			3/4	FSCC-1-75	—
	FDCC	Deep	1/2	FDCC-1-50	—
			3/4	FDCC-1-75	FDCC-1-75-A
			1	FDCC-1-100	—
	FSCT	Shallow	1/2	FSCT-1-50	—
			3/4	FSCT-1-75	—
			1	FSCT-1-100	—
	FDCT	Deep	1/2	FDCT-1-50	—
			3/4	FDCT-1-75	—
			1	FDCT-1-100	—
	FST	Shallow	1/2	FST-1-50	—
			3/4	FST-1-75	—
	FDT	Deep	1/2	FDT-1-50	—
			3/4	FDT-1-75	—
			1	FDT-1-100	—
	FSX	Shallow	1/2	FSX-1-50	—
			3/4	FSX-1-75	—
	FDX	Deep	1/2	FDX-1-50	—
			3/4	FDX-1-75	—
			1	FDX-1-100	—
	FSCD	Shallow	1/2	FSCD-1-50	—
			3/4	FSCD-1-75	—

Fittings

FITTINGS: CAST DEVICE BOXES

FS and FD Single Gang and Tandem Cast Hub Device Boxes

UNILETS® for use with Threaded Rigid Metal Conduit and IMC. FS Box 2.00" Deep, FD Box 2.69" Deep. Furnished with Internal Ground Screw.

FS Box (Shallow) 2.00" deep, FD Box (Deep) 2.69" deep					
	Type	Depth	Hub Size (Inches)	Catalog Number	
				Malleable Iron Ridge Top	Aluminum Ridge Top
FS and FD Single Gang Boxes with Mounting Lugs					
	FS	Shallow	1/2	FS-1-50L	—
			3/4	FS-1-75L	—
	FD	Deep	1/2	FD-1-50L	FD-1-50L-A
			3/4	FD-1-75L	FD-1-75L-A
1			FD-1-100	FD-1-100-A	
	FSC	Shallow	1/2	FSC-1-50L	—
			3/4	FSC-1-75L	—
	FDC	Deep	1/2	FDC-1-50L	FDC-1-50L-A
			3/4	FDC-1-75L	FDC-1-75L-A
			1	FDC-1-100	FDC-1-100-A
FS Single Gang Boxes with Double Opening					
	FS	3.38"	1/2	FS-1D-50	—
			3/4	FS-1D-75	—
	FSC	3.38"	1/2	FSC-1D-50	—
			3/4	FSC-1D-75	—
FS Two-Gang Tandem Boxes – Takes single gang covers					
	FS	Shallow	1/2	FS-2T-50	—
			3/4	FS-2T-75	—
	FSC	Shallow	1/2	FSC-2T-50	—
			3/4	FSC-2T-75	—
	FS	1" Extension	—	FS-1EXT	—

Fittings

FITTINGS: CAST DEVICE BOXES

FS and FD Single Gang and Tandem Cast Hub Device Box Covers

Steel Covers and Aluminum Covers for Ridge Top Boxes. Furnished with Stainless Steel Screws, Less Gasket.

	Description	Catalog Number	
		Steel	Aluminum
	For double push button switches, momentary contact and maintain switches.	FSK-1PB	—
	For square handle tumbler or toggle switches.	FSK-1TS	FSK-1TS-A
	For square handle tumbler or toggle switches. Has toggle guard.	FSK-1TSG	—
	For two or three interchangeable devices. Includes mounting bracket.	FSK-1WD-3	—
	For round flush receptacles, without lift cover. Mounts on device. Hole Dia. — 1-13/32".	FSK-1R-Q	FSK-1R-Q-A
	For round flush receptacles, with lift cover. Mounts on device. Hole Dia. — 1-13/32".	FSK-1R-T	—
	For round receptacles. Mounts directly on box. Hole Dia. — 1-13/32".	FSK-1R-W	FSK-1R-W-A
	For round receptacles. Mounts directly on box. Hole Dia. — 1-5/8". 3-9/32" C to C screw holes.	FSK-1R-X	—
	For round receptacles. Mounts on device. Hole Dia. — 1-5/8". 2-3/8" C to C screw holes.	FSK-1R-Y	FSK-1R-Y-A
	For standard 2 or 3 wire duplex receptacles.	FSK-1DR *	FSK-1DR-A
	For pilot lamp: Red Jewel	FSK-1J	—
	Amber Jewel	FSK-1JA	—
	Green Jewel	FSK-1JG	—
	Opal Jewel	FSK-1JO	—
	Blank	FSK-1B	FSK-1B-A

* PVC coating available on select covers. Add suffix **-PVC** to catalog number.

FS and FD Single Gang and Tandem Cast Hub Device Box Covers

Covers for Ridge Top Boxes.

	Description	Catalog Number	
		Malleable Iron	Aluminum
Cast Covers NEMA 3R Wet Locations — Furnished with gasket and stainless steel screws			
	Receptacle cover with spring cover. Hole Diameter — 1-7/16"	FSK-1VR	FSK-1VR-A
	For duplex flush receptacle with spring cover	FSK-1VDR	FSK-1VDR-A
	For pilot lamp flush receptacles:		
	Red Jewel	FSK-1J-C	FSK-1-JCA
	Opal Jewel	FSK-1JOC	FSK-1JOCA
	Amber Jewel	FSK-1JAC	FSK-1JACA
	Green Jewel	FSK-1JGC	FSK-1JGCA
	For double push button switches	FSK-1PBS	—
	For external operation of tumbler switches with square handles	FSK-1VTS	FSK-1VTSA
	Operating type for square handle tumbler or toggle switches	FSK-1VS	FSK-1VS-A
	Rocker type for square handle tumbler or toggle flush switches	FSK-1V	FSK-1V-A
	Blank	FSK-1B-C *	FSK-1B-CA
Gasket — Replacement			
	Neoprene—for use with wet location covers	FS-GKR-1N	FS-GKR-1N
Cast Covers Dry Locations — Furnished with stainless steel screws less gasket			
	For standard 2 or 3 wire duplex receptacles	FSK-1DR-C	—
	For round flush receptacles Hole Dia. — 1-7/16"	FSK-1R-Z *	—
	For square handle toggle switches	FSK-1TS-C	—
	For square handle toggle switches; Has toggle guard	FSK-1TSG-C *	FSK-1TSG-CA

* PVC coating available on select covers. Add suffix **-PVC** to catalog number.

FS and FD Single Gang and Tandem Cast Hub Device Box Wiring Capacity and Dimensions

Wiring Capacity

Hub Size (inches)	Single-Gang FS	Capacity (in ³ /dm ³)	
		Single-Gang FD	Two-Gang Tandem FS
1/2	18.00/0.29	25.00/0.41	40.00/0.66
3/4	18.00/0.29	25.00/0.41	40.00/0.66
1	18.00/0.29	25.00/0.41	40.00/0.66

Dimensions

FS and FD Single Gang Boxes without lugs

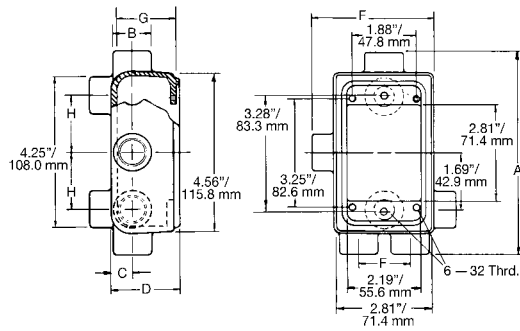

FS Tandem Boxes



FS and FD Single Gang Boxes with lugs

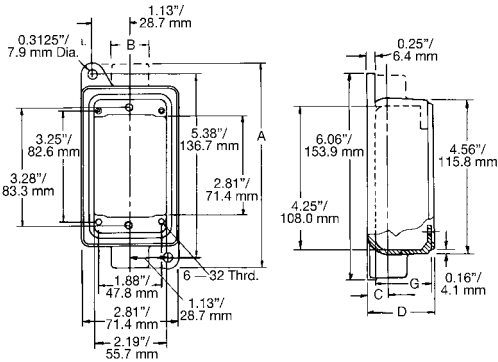

Hub Size (Inches)	Dimensions in Inches/Millimeters									
	D									
	A	B	C	"FS"	"FD"	E	F	G		H
1/2	5.88/149.4	1.13/28.7	0.63/16.0	2.00/50.8	2.69/68.3	1.50/38.1	3.50/88.9	1.78/45.2	2.44/62.0	1.69/42.9
3/4	5.88/149.4	1.38/35.1	0.75/19.1	2.00/50.8	2.69/68.3	2.06/52.3	3.50/88.9	1.78/45.2	2.44/62.0	1.50/38.1
1	6.31/160.3	1.69/42.9	0.94/23.9	2.00/50.8	2.69/68.3	2.06/52.3	3.50/88.9	1.78/45.2	2.44/62.0	1.38/35.1

Fittings

FITTINGS: CAST DEVICE BOXES

Wet Location Receptacle Covers

Available with NEMA Configuration Receptacles or as Covers Only

Covers also accommodate Toggle Switches.

Applications

- Meet NEC 406.8(B) and CEC receptacle requirements for wet locations: "A receptacle installed outdoors where exposed to weather or in other wet locations shall be in a weatherproof enclosure, the integrity of which is not affected when the receptacle is in use (attachment plug cap inserted)."
- For industrial, commercial or residential use as a general purpose receptacle or for powering portable equipment not exceeding medium duty ratings.
- Mounts on FS or FD device boxes or equivalents, either single gang or multiple gang with single gang openings.

Features

- Provides full protection in damp or wet locations per NEC 406.8(B) and CEC. Gasketed spring door cover closes tightly automatically to protect receptacle from moisture and dirt when not in use. With plug inserted, a heavy-duty gasket in throat of receptacle seals around it to keep out moisture and dirt.
- Receptacle interiors comply with NEMA Standards WD-1 and WD-5.
- Receptacle interiors are specification grade, back and side-wired.
- Single cover units accommodate NEMA configuration receptacles for locking or non-locking blade plugs, or toggle switches. Duplex units accommodate one receptacle and one toggle switch or any combination of the two.
- Covers open all the way, permitting easy plug insertion and withdrawal. Also permits adequate access to cover screws for easy attachment of cover to FS, FD or other device box. Large head cover screws are captivated.
- Unique design of spring door hinge provides smooth action. Duplex units have a separate hinge shaft for each spring door cover to reduce stress on the shafts.
- Spring door cover puts pressure on plug (without tilting plug) to hold plug in best position for providing optimum weatherproof seal.
- Stainless steel hinge springs are completely enclosed — inside and out — for superior resistance against corrosion.
- EPDM gaskets provide superior resistance to the weather, ozone and temperatures between -50 °F/-45.6 °C and 260 °F/126.7 °C.
- Diecast copperfree cover assemblies with epoxy powder coat (electrostatically applied for uniform coverage) to provide protection against corrosion.

Illustrated Features



Typical application with NEMA configuration receptacle and plug, mounted on an FS box. Gasket seals around plug, keeping out moisture and dirt. Spring door closes automatically when plug is withdrawn to protect receptacle.



Duplex Cover on FS Box.



Single Cover on FS Box.

- Positive ground path assured for all exposed metal parts.
- Receptacle interiors grounded through an extra contact in all types. Self-grounded in duplex units.

Standard Materials

- Cover and faceplate: diecast copperfree (4/10 of 1%) aluminum
- Gaskets: ethylene propylene rubber (EPDM)
- Cover and device screws: stainless steel, 6—32 thread
- Hinge springs: stainless steel
- Hinge shaft: nylon
- FSK-SBA adapter: steel plate with closed cell sponged neoprene gasket

Standard Finishes

- Cover and faceplate: epoxy powder coat
- FSK-SBA adapter: zinc electroplate

Certifications and Compliances

- UL Standard: 514A
- UL Listed: E2527
- NEMA Standards: FB-1, OS-1



Spring doors open wide for easy plug insertion and cover assembly (covers shown in open position for illustration only). This view shows gaskets that protect plugs. Gasket on bottom of cover prevents entry of moisture into device box (see gasket description).

Wet Location Receptacle Covers

Available with NEMA Configuration Receptacles or as Covers Only

Covers also accommodate Toggle Switches.

NEMA 3R

	Amp	Wire/Pole	Volts	NEMA Configuration	Catalog Number	
					With Receptacle	Cover Only
Duplex Cover for Non-Locking Blade Plugs, with 1-3/8" Device Opening						
	15	2P, 3W	125	5-15R	FSKD5-15	FSK-WRD
	15	2P, 3W	250	6-15R	FSKD6-15	FSK-WRD
	20	2P, 3W	125	5-20R	FSKD5-20	FSK-WRD
			250	6-20R	FSKD6-20	FSK-WRD
Single Cover for Non-Locking and Locking Blade Plugs, with 1-3/8" Device Opening						
	15	2P, 3W	125	5-15R	FSKJ5-15	FSK-WR1
	15	2P, 3W	250	6-15R	FSKJ6-15	FSK-WR1
	20	2P, 3W	125	5-20R	FSKJ5-20	FSK-WR1
	20	2P, 3W	250	6-20R	FSKJ6-20	FSK-WR1
	15	2P, 3W	125	L5-15R	FSKJL5-15	FSK-WR1
	15	2P, 3W	250	L6-15R	FSKJL6-15	FSK-WR1
	15	2P, 3W	277	L7-15R	FSKJL7-15	FSK-WR1
Single Cover for Locking Blade Plugs, with 1-19/32" Device Opening						
Accommodates NEMA configuration receptacles with 1-19/32" device opening.					—	FSK-WR2
Single Cover for GFI — Meets NEMA 3R Wet Location in Closed Position Only						
GFI Cover Only					—	FSK-WGF1
Single Cover for Toggle Switches (1-19/32" opening)						
Accommodates Toggle Switch. Furnished with Toggle Switch Plate to provide protection from exposed terminal wires of Toggle Switch.					—	FSK-WT2
Adapter/Gasket						
For mounting Receptacle Cover on Switch Boxes (not required on FS/FD Boxes)						FSK-SBA

FITTINGS: CAST DEVICE BOXES

Dimensions in Inches/Millimeters



Receptacle Cover mounted on Switch Box with FSK-SBA Adapter/Gasket



NOTE: All receptacle covers have an overall height of 1.16 in/29.5 mm.

FS and FD Two Gang Cast Device Boxes

UNILETS® for use with Threaded Rigid Metal Conduit and IMC. Furnished with Internal Ground Screw.

FS Box (Shallow) 2.00" deep, FD Box (Deep) 2.69" deep

	Type	Depth	Hub Size (Inches)	Catalog Number	
				Malleable Iron Ridge Top	Aluminum Ridge Top
	FS	Shallow	1/2	FS-2-50	FS-2-50-A
			3/4	FS-2-75	FS-2-75-A
			1	FS-2-100	—
	FD	Deep	1/2	FD-2-50	—
			3/4	FD-2-75	FD-2-75-A
			1	FD-2-100	—
	FSC	Shallow	1/2	FSC-2-50	—
			3/4	FSC-2-75	—
			1	FSC-2-100	—
	FDC	Deep	1/2	FDC-2-50	—
			3/4	FDC-2-75	FDC-2-75-A
			1	FDC-2-100	—
	FSS	Shallow	1/2	FSS-2-50	—
			3/4	FSS-2-75	FSS-2-75-A
			1	FSS-2-100	—
	FDS	Deep	3/4	FDS-2-75	—
					—
					—
	FSD	Shallow †	1/2-3/4	FSD-2-75	—
	FS	1" Extension *	—	FS-2EXT	—

† Largest hub at bottom in illustration.

* Extension does not have a ground screw.

FS and FD Two Gang Cast Hub Device Box Covers for Ridge Top Boxes

	Description	Catalog Number	
		Steel	Aluminum
Stamped Steel and Aluminum Covers — With stainless steel screws, less gasket			
	For square handle tumbler or toggle flush switches	FSK-2TS	FSK-2TS-A
	For two round receptacles. Mounts on device. Hole Dia. – 1-13/32"	FSK-2R-Q	—
	For two round receptacles. Mounts directly on box. Hole Dia. – 1-13/32"	FSK-2R-W	—
	For round flush receptacles, with lift cover. Mounts on device. Hole Dia. – 1-13/32"	FSK-2R-T	—
	For duplex flush receptacles	FSK-2DR	FSK-2DR-A
	For tumbler flush switch and duplex flush receptacles	FSK-2RS-K	—
	For round flush receptacle and duplex receptacles Hole Dia. – 1-13/32"	FSK-2R-L	—
	For round receptacles. Hole Dia. – 2-15/32	FSK-2R-M	—
	Blank Cover	FSK-2B	FSK-2B-A
		Malleable Iron	Aluminum
Cast Covers — Weatherproof — With gasket and stainless steel screws			
	For external operation of tumbler switches with square handles	FSK-2VTS	FSK-2VTS-A
	Blank Cover	FSK-2B-CM	FSK-2B-CA
	Gasket — Replacement Neoprene — for use with 2-gang cast covers above	FS-GKR-2N	—

Fittings

FITTINGS: CAST DEVICE BOXES

FS and FD Two Gang and Cast Hub Device Box Wiring Capacity and Dimensions

Wiring Capacity

Hub Size (inches)	Capacity (in ³ /dm ³)	
	FS	FD
1/2	32.00/0.52	45.00/0.74
3/4	32.00/0.52	45.00/0.74
1	32.00/0.52	45.00/0.74

Dimensions



Hub Size (inches)	Dimensions in Inches/Millimeters							
	A	B	C	D		E	F	
				"FS"	"FD"		"FS"	"FD"
1/2	5.88/149.4	1.13/28.7	0.63/16.0	2.00/50.8	2.69/68.3	1.88/47.8	1.78/45.2	2.44/62.0
3/4	5.88/149.4	1.38/35.1	0.75/19.1	2.00/50.8	2.69/68.3	1.88/47.8	1.78/45.2	2.44/62.0
1	6.31/160.3	1.69/42.9	0.94/23.9	2.00/50.8	2.69/68.3	2.06/52.3	1.78/45.2	2.44/62.0



Fittings

FITTINGS: CAST DEVICE BOXES





FS Three Gang Cast Device Boxes and Stamped and Cast Covers for Ridge Top Boxes

UNILETS® for use with Threaded Rigid Metal Conduit and IMC. Furnished with Internal Ground Screw.

Three Gang Cast Device Boxes

	Type	Depth	Hub Size (Inches)	Catalog Number Malleable Iron Ridge Top
	FS	Shallow	3/4	FS-3-75
			1	FS-3-100
	FSS	Shallow	3/4	FSS-3-75

Cast Device Covers

	Description	Catalog Number
Stamped Steel Covers – Furnished with stainless steel screws, less gasket		
	For square handle tumbler or toggle flush switches	FSK-3TS
	Blank Cover	FSK-3B
Malleable Iron Cast Covers – Weatherproof – Furnished with gasket and stainless steel screws		
	Blank Cast Cover	FSK-3B-CM
Gasket – Replacement		
	Neoprene – for use with 3-gang covers above	FS-GKR-3N

Fittings

FITTINGS: CAST DEVICE BOXES

FS Three Gang Cast Device Box Wiring Capacity and Dimensions

Wiring Capacity

Hub Size (inches)	Capacity (in ³ /dm ³) FS
1/2	40.00/0.66
3/4	40.00/0.66
1	40.00/0.66

Dimensions in Inches/Millimeters



Hub Size (inches)	Dimensions in Inches/Millimeters					
	A	B	C	D	E	F
1/2	5.88/149.4	1.13/28.7	0.63/16.0	2.00/50.8	1.88/47.8	1.78/45.2
3/4	5.88/149.4	1.38/35.1	0.75/19.1	2.00/50.8	1.88/47.8	1.78/45.2
1	6.31/190.3	1.69/42.9	0.94/23.9	2.00/50.8	2.13/54.1	1.78/45.2

Fittings

FITTINGS: CAST DEVICE BOXES

FS and FD Cast Hub Device Boxes

UNILETS® for use with Threaded Rigid Conduit and IMC. All Device Boxes have Ridge Top Construction. Furnished with Internal Ground Screw.

Applications

- Accommodate wiring devices such as switches and receptacles.
- Provide excellent service in areas where boxes are subject to rough usage.
- Serve as pull boxes for conductors.
- Permit access to conductors for maintenance.
- Provide openings for making splices.
- Allow connections for branch conduit runs.
- Blank bodies for special conduit entrance arrangements.

Features

- Corrosion-resistant — ideal for indoor and outdoor installations.
- Weatherproof, raintight and dust-tight when used with cast gasketed covers.
- FS and FD boxes take standard flush wiring devices.
- FD boxes take devices exceeding 1.63 in/41.4 mm in depth under fastening ears.
- Malleable iron for high tensile strength and ductility — provides greater resistance to impact and shock.
- Both malleable iron and aluminum boxes have ridge top construction for positive cover/gasket/box fit.
- Accurately tapped, tapered threads for tight, rigid joints, ground continuity.
- Complete selection of covers, receptacles, plugs, gaskets and accessories.
- Covers have captive stainless steel screws to speed installation, prevents loss of screws.
- Internal grounding screws standard.
- Available in single, two and three gang and tandem.
- Smooth, rounded integral bushing in each hub protects conductor insulation.

Standard Materials

- Boxes: malleable iron or copperfree (4/10 of 1% max.) aluminum
- Covers: malleable iron, steel, or copperfree (4/10 of 1% max.) aluminum
- Screws: stainless steel
- Gaskets: neoprene

Standard Finishes

- Malleable iron boxes and covers: triple-coat — (1) zinc electroplate, (2) chromate, and (3) epoxy powder coat
- Aluminum boxes and covers: epoxy powder coat
- Steel covers: zinc electroplate

Certifications and Compliances

- UL Standard: 514A
- UL Listed: E2527
- CSA Standard: C22.2 No. 18.1
- CSA Certified: 001472
- NEMA Standard: FB-1

Options

- PVC coating available on select bodies and covers. Add suffix **-PVC** to catalog number.



Illustrated Features



Gasket is designed so that it wraps around ridge top of Appleton aluminum or malleable iron device box. Result is a positive seal against moisture.



Gasket construction. Cover tightens on largest perimeter of gasket and fits snugly against portion of gasket that wraps around ridge top of box.

FS and FD Single Gang Cast Hub Device Boxes

UNILETS® for use with Threaded Rigid Metal Conduit and IMC. Furnished with Internal Ground Screw.

FS Box (Shallow) 2.00" deep, FD Box (Deep) 2.69" deep					
	Type	Depth	Hub Size (Inches)	Catalog Number	
				Malleable Iron Ridge Top	Aluminum Ridge Top
	FS	Shallow	1/2	FS-1-50 *	FS-1-50-A *
			3/4	FS-1-75 *	FS-1-75-A *
			1	FS-1-100 *	FS-1-100-A *
	FD	Deep	1/2	FD-1-50 *	FD-1-50-A *
			3/4	FD-1-75 *	FD-1-75-A *
			1	FD-1-100 *	FD-1-100-A *
	FSC	Shallow	1/2	FSC-1-50 *	FSC-1-50-A *
			3/4	FSC-1-75 *	FSC-1-75-A *
			1	FSC-1-100 *	FSC-1-100-A *
	FDC	Deep	1/2	FDC-1-50 *	FDC-1-50-A *
			3/4	FDC-1-75 *	FDC-1-75-A *
			1	FDC-1-100 *	FDC-1-100-A *
	FSS	Shallow	1/2	FSS-1-50	FSS-1-50-A
			3/4	FSS-1-75	FSS-1-75-A
			1	FSS-1-100	FSS-1-100-A
	FDS	Deep	1/2	FDS-1-50	FDS-1-50-A
			3/4	FDS-1-75	FDS-1-75-A
			1	FDS-1-100	FDS-1-100-A
	FSLA	Shallow	1/2	FSLA-1-50	—

Fittings

FITTINGS: CAST DEVICE BOXES

* PVC coating available on select bodies. Add suffix **-PVC** to catalog number.

FS and FD Single Gang Cast Hub Device Boxes

UNILETS® for use with Threaded Rigid Metal Conduit and IMC. FS Box 2.00" Deep, FD Box 2.69" Deep. Furnished with Internal Ground Screw.

FS Box (Shallow) 2.00" deep, FD Box (Deep) 2.69" deep

	Type	Depth	Hub Size (Inches)	Catalog Number	
				Malleable Iron Ridge Top	Aluminum Ridge Top
	FSCA	Shallow	1/2	FSCA-1-50	—
			3/4	FSCA-1-75	—
	FSCC	Shallow	1/2	FSCC-1-50	—
			3/4	FSCC-1-75	—
	FDCC	Deep	1/2	FDCC-1-50	—
			3/4	FDCC-1-75	FDCC-1-75-A
			1	FDCC-1-100	—
	FSCT	Shallow	1/2	FSCT-1-50	—
			3/4	FSCT-1-75	—
			1	FSCT-1-100	—
FDCT	Deep	1/2	FDCT-1-50	—	
		3/4	FDCT-1-75	—	
		1	FDCT-1-100	—	
	FST	Shallow	1/2	FST-1-50	—
			3/4	FST-1-75	—
FDT	Deep	1/2	FDT-1-50	—	
		3/4	FDT-1-75	—	
		1	FDT-1-100	—	
	FSX	Shallow	1/2	FSX-1-50	—
			3/4	FSX-1-75	—
FDX	Deep	1/2	FDX-1-50	—	
		3/4	FDX-1-75	—	
		1	FDX-1-100	—	
	FSCD	Shallow	1/2	FSCD-1-50	—
			3/4	FSCD-1-75	—

Fittings

FITTINGS: CAST DEVICE BOXES

FS and FD Single Gang and Tandem Cast Hub Device Boxes

UNILETS® for use with Threaded Rigid Metal Conduit and IMC. FS Box 2.00" Deep, FD Box 2.69" Deep. Furnished with Internal Ground Screw.

FS Box (Shallow) 2.00" deep, FD Box (Deep) 2.69" deep					
	Type	Depth	Hub Size (Inches)	Catalog Number	
				Malleable Iron Ridge Top	Aluminum Ridge Top
FS and FD Single Gang Boxes with Mounting Lugs					
	FS	Shallow	1/2	FS-1-50L	—
			3/4	FS-1-75L	—
	FD	Deep	1/2	FD-1-50L	FD-1-50L-A
			3/4	FD-1-75L	FD-1-75L-A
1			FD-1-100	FD-1-100-A	
	FSC	Shallow	1/2	FSC-1-50L	—
			3/4	FSC-1-75L	—
	FDC	Deep	1/2	FDC-1-50L	FDC-1-50L-A
			3/4	FDC-1-75L	FDC-1-75L-A
1			FDC-1-100	FDC-1-100-A	
FS Single Gang Boxes with Double Opening					
	FS	3.38"	1/2	FS-1D-50	—
			3/4	FS-1D-75	—
	FSC	3.38"	1/2	FSC-1D-50	—
			3/4	FSC-1D-75	—
FS Two-Gang Tandem Boxes – Takes single gang covers					
	FS	Shallow	1/2	FS-2T-50	—
			3/4	FS-2T-75	—
	FSC	Shallow	1/2	FSC-2T-50	—
			3/4	FSC-2T-75	—
	FS	1" Extension	—	FS-1EXT	—

Fittings

FITTINGS: CAST DEVICE BOXES

FS and FD Single Gang and Tandem Cast Hub Device Box Covers













Steel Covers and Aluminum Covers for Ridge Top Boxes. Furnished with Stainless Steel Screws, Less Gasket.

	Description	Catalog Number	
		Steel	Aluminum
	For double push button switches, momentary contact and maintain switches.	FSK-1PB	—
	For square handle tumbler or toggle switches.	FSK-1TS	FSK-1TS-A
	For square handle tumbler or toggle switches. Has toggle guard.	FSK-1TSG	—
	For two or three interchangeable devices. Includes mounting bracket.	FSK-1WD-3	—
	For round flush receptacles, without lift cover. Mounts on device. Hole Dia. — 1-13/32".	FSK-1R-Q	FSK-1R-Q-A
	For round flush receptacles, with lift cover. Mounts on device. Hole Dia. — 1-13/32".	FSK-1R-T	—
	For round receptacles. Mounts directly on box. Hole Dia. — 1-13/32".	FSK-1R-W	FSK-1R-W-A
	For round receptacles. Mounts directly on box. Hole Dia. — 1-5/8". 3-9/32" C to C screw holes.	FSK-1R-X	—
	For round receptacles. Mounts on device. Hole Dia. — 1-5/8". 2-3/8" C to C screw holes.	FSK-1R-Y	FSK-1R-Y-A
	For standard 2 or 3 wire duplex receptacles.	FSK-1DR *	FSK-1DR-A
	For pilot lamp: Red Jewel	FSK-1J	—
	Amber Jewel	FSK-1JA	—
	Green Jewel	FSK-1JG	—
	Opal Jewel	FSK-1JO	—
	Blank	FSK-1B	FSK-1B-A

* PVC coating available on select covers. Add suffix **-PVC** to catalog number.

FS and FD Single Gang and Tandem Cast Hub Device Box Covers

Covers for Ridge Top Boxes.

	Description	Catalog Number	
		Malleable Iron	Aluminum
Cast Covers NEMA 3R Wet Locations — Furnished with gasket and stainless steel screws			
	Receptacle cover with spring cover. Hole Diameter — 1-7/16"	FSK-1VR	FSK-1VR-A
	For duplex flush receptacle with spring cover	FSK-1VDR	FSK-1VDR-A
	For pilot lamp flush receptacles:		
	Red Jewel	FSK-1J-C	FSK-1-JCA
	Opal Jewel	FSK-1JOC	FSK-1JOCA
	Amber Jewel	FSK-1JAC	FSK-1JACA
	Green Jewel	FSK-1JGC	FSK-1JGCA
	For double push button switches	FSK-1PBS	—
	For external operation of tumbler switches with square handles	FSK-1VTS	FSK-1VTSA
	Operating type for square handle tumbler or toggle switches	FSK-1VS	FSK-1VS-A
	Rocker type for square handle tumbler or toggle flush switches	FSK-1V	FSK-1V-A
	Blank	FSK-1B-C *	FSK-1B-CA
Gasket — Replacement			
	Neoprene—for use with wet location covers	FS-GKR-1N	FS-GKR-1N
Cast Covers Dry Locations — Furnished with stainless steel screws less gasket			
	For standard 2 or 3 wire duplex receptacles	FSK-1DR-C	—
	For round flush receptacles Hole Dia. — 1-7/16"	FSK-1R-Z *	—
	For square handle toggle switches	FSK-1TS-C	—
	For square handle toggle switches; Has toggle guard	FSK-1TSG-C *	FSK-1TSG-CA

* PVC coating available on select covers. Add suffix **-PVC** to catalog number.

FS and FD Single Gang and Tandem Cast Hub Device Box Wiring Capacity and Dimensions

Wiring Capacity

Hub Size (inches)	Single-Gang FS	Capacity (in ³ /dm ³)	
		Single-Gang FD	Two-Gang Tandem FS
1/2	18.00/0.29	25.00/0.41	40.00/0.66
3/4	18.00/0.29	25.00/0.41	40.00/0.66
1	18.00/0.29	25.00/0.41	40.00/0.66

Dimensions

FS and FD Single Gang Boxes without lugs

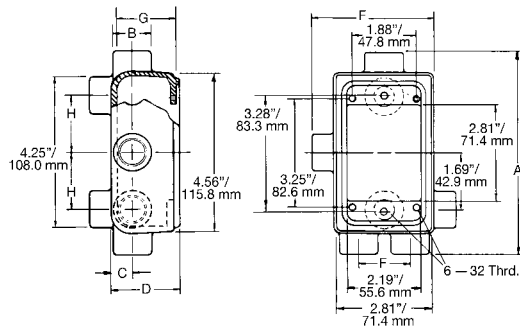

FS Tandem Boxes



FS and FD Single Gang Boxes with lugs

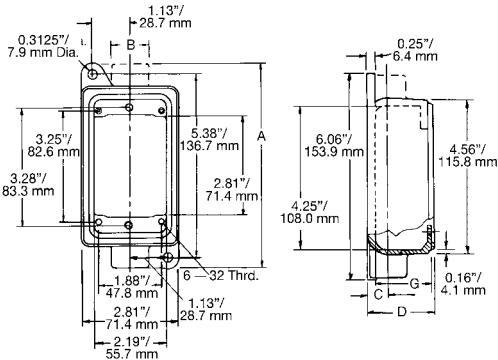

Hub Size (Inches)	Dimensions in Inches/Millimeters									
	D									
	A	B	C	"FS"	"FD"	E	F	"FS"	"FD"	H
1/2	5.88/149.4	1.13/28.7	0.63/16.0	2.00/50.8	2.69/68.3	1.50/38.1	3.50/88.9	1.78/45.2	2.44/62.0	1.69/42.9
3/4	5.88/149.4	1.38/35.1	0.75/19.1	2.00/50.8	2.69/68.3	2.06/52.3	3.50/88.9	1.78/45.2	2.44/62.0	1.50/38.1
1	6.31/160.3	1.69/42.9	0.94/23.9	2.00/50.8	2.69/68.3	2.06/52.3	3.50/88.9	1.78/45.2	2.44/62.0	1.38/35.1

Fittings

FITTINGS: CAST DEVICE BOXES

Wet Location Receptacle Covers

Available with NEMA Configuration Receptacles or as Covers Only

Covers also accommodate Toggle Switches.

Applications

- Meet NEC 406.8(B) and CEC receptacle requirements for wet locations: "A receptacle installed outdoors where exposed to weather or in other wet locations shall be in a weatherproof enclosure, the integrity of which is not affected when the receptacle is in use (attachment plug cap inserted)."
- For industrial, commercial or residential use as a general purpose receptacle or for powering portable equipment not exceeding medium duty ratings.
- Mounts on FS or FD device boxes or equivalents, either single gang or multiple gang with single gang openings.

Features

- Provides full protection in damp or wet locations per NEC 406.8(B) and CEC. Gasketed spring door cover closes tightly automatically to protect receptacle from moisture and dirt when not in use. With plug inserted, a heavy-duty gasket in throat of receptacle seals around it to keep out moisture and dirt.
- Receptacle interiors comply with NEMA Standards WD-1 and WD-5.
- Receptacle interiors are specification grade, back and side-wired.
- Single cover units accommodate NEMA configuration receptacles for locking or non-locking blade plugs, or toggle switches. Duplex units accommodate one receptacle and one toggle switch or any combination of the two.
- Covers open all the way, permitting easy plug insertion and withdrawal. Also permits adequate access to cover screws for easy attachment of cover to FS, FD or other device box. Large head cover screws are captivated.
- Unique design of spring door hinge provides smooth action. Duplex units have a separate hinge shaft for each spring door cover to reduce stress on the shafts.
- Spring door cover puts pressure on plug (without tilting plug) to hold plug in best position for providing optimum weatherproof seal.
- Stainless steel hinge springs are completely enclosed — inside and out — for superior resistance against corrosion.
- EPDM gaskets provide superior resistance to the weather, ozone and temperatures between -50 °F/-45.6 °C and 260 °F/126.7 °C.
- Diecast copperfree cover assemblies with epoxy powder coat (electrostatically applied for uniform coverage) to provide protection against corrosion.

Illustrated Features



Typical application with NEMA configuration receptacle and plug, mounted on an FS box. Gasket seals around plug, keeping out moisture and dirt. Spring door closes automatically when plug is withdrawn to protect receptacle.



Duplex Cover on FS Box.



Single Cover on FS Box.

- Positive ground path assured for all exposed metal parts.
- Receptacle interiors grounded through an extra contact in all types. Self-grounded in duplex units.

Standard Materials

- Cover and faceplate: diecast copperfree (4/10 of 1%) aluminum
- Gaskets: ethylene propylene rubber (EPDM)
- Cover and device screws: stainless steel, 6—32 thread
- Hinge springs: stainless steel
- Hinge shaft: nylon
- FSK-SBA adapter: steel plate with closed cell sponged neoprene gasket

Standard Finishes

- Cover and faceplate: epoxy powder coat
- FSK-SBA adapter: zinc electroplate

Certifications and Compliances

- UL Standard: 514A
- UL Listed: E2527
- NEMA Standards: FB-1, OS-1



Spring doors open wide for easy plug insertion and cover assembly (covers shown in open position for illustration only). This view shows gaskets that protect plugs. Gasket on bottom of cover prevents entry of moisture into device box (see gasket description).

Wet Location Receptacle Covers

Available with NEMA Configuration Receptacles or as Covers Only

Covers also accommodate Toggle Switches.

NEMA 3R

	Amp	Wire/Pole	Volts	NEMA Configuration	Catalog Number	
					With Receptacle	Cover Only
Duplex Cover for Non-Locking Blade Plugs, with 1-3/8" Device Opening						
	15	2P, 3W	125	5-15R	FSKD5-15	FSK-WRD
	15	2P, 3W	250	6-15R	FSKD6-15	FSK-WRD
	20	2P, 3W	125	5-20R	FSKD5-20	FSK-WRD
			250	6-20R	FSKD6-20	FSK-WRD
Single Cover for Non-Locking and Locking Blade Plugs, with 1-3/8" Device Opening						
	15	2P, 3W	125	5-15R	FSKJ5-15	FSK-WR1
	15	2P, 3W	250	6-15R	FSKJ6-15	FSK-WR1
	20	2P, 3W	125	5-20R	FSKJ5-20	FSK-WR1
	20	2P, 3W	250	6-20R	FSKJ6-20	FSK-WR1
	15	2P, 3W	125	L5-15R	FSKJL5-15	FSK-WR1
	15	2P, 3W	250	L6-15R	FSKJL6-15	FSK-WR1
	15	2P, 3W	277	L7-15R	FSKJL7-15	FSK-WR1
Single Cover for Locking Blade Plugs, with 1-19/32" Device Opening						
Accommodates NEMA configuration receptacles with 1-19/32" device opening.					—	FSK-WR2
Single Cover for GFI — Meets NEMA 3R Wet Location in Closed Position Only						
GFI Cover Only					—	FSK-WGF1
Single Cover for Toggle Switches (1-19/32" opening)						
Accommodates Toggle Switch. Furnished with Toggle Switch Plate to provide protection from exposed terminal wires of Toggle Switch.					—	FSK-WT2
Adapter/Gasket						
For mounting Receptacle Cover on Switch Boxes (not required on FS/FD Boxes)						FSK-SBA

FITTINGS: CAST DEVICE BOXES

Dimensions in Inches/Millimeters



Receptacle Cover mounted on Switch Box with FSK-SBA Adapter/Gasket



NOTE: All receptacle covers have an overall height of 1.16 in/29.5 mm.

FS and FD Two Gang Cast Device Boxes

UNILETS® for use with Threaded Rigid Metal Conduit and IMC. Furnished with Internal Ground Screw.

FS Box (Shallow) 2.00" deep, FD Box (Deep) 2.69" deep

	Type	Depth	Hub Size (Inches)	Catalog Number	
				Malleable Iron Ridge Top	Aluminum Ridge Top
	FS	Shallow	1/2	FS-2-50	FS-2-50-A
			3/4	FS-2-75	FS-2-75-A
			1	FS-2-100	—
	FD	Deep	1/2	FD-2-50	—
			3/4	FD-2-75	FD-2-75-A
			1	FD-2-100	—
	FSC	Shallow	1/2	FSC-2-50	—
			3/4	FSC-2-75	—
			1	FSC-2-100	—
	FDC	Deep	1/2	FDC-2-50	—
			3/4	FDC-2-75	FDC-2-75-A
			1	FDC-2-100	—
	FSS	Shallow	1/2	FSS-2-50	—
			3/4	FSS-2-75	FSS-2-75-A
			1	FSS-2-100	—
	FDS	Deep	3/4	FDS-2-75	—
					—
					—
	FSD	Shallow †	1/2-3/4	FSD-2-75	—
	FS	1" Extension *	—	FS-2EXT	—

† Largest hub at bottom in illustration.

* Extension does not have a ground screw.

Fittings

FITTINGS: CAST DEVICE BOXES

FS and FD Two Gang Cast Hub Device Box Covers for Ridge Top Boxes

	Description	Catalog Number	
		Steel	Aluminum
Stamped Steel and Aluminum Covers — With stainless steel screws, less gasket			
	For square handle tumbler or toggle flush switches	FSK-2TS	FSK-2TS-A
	For two round receptacles. Mounts on device. Hole Dia. – 1-13/32"	FSK-2R-Q	—
	For two round receptacles. Mounts directly on box. Hole Dia. – 1-13/32"	FSK-2R-W	—
	For round flush receptacles, with lift cover. Mounts on device. Hole Dia. – 1-13/32"	FSK-2R-T	—
	For duplex flush receptacles	FSK-2DR	FSK-2DR-A
	For tumbler flush switch and duplex flush receptacles	FSK-2RS-K	—
	For round flush receptacle and duplex receptacles Hole Dia. – 1-13/32"	FSK-2R-L	—
	For round receptacles. Hole Dia. – 2-15/32	FSK-2R-M	—
	Blank Cover	FSK-2B	FSK-2B-A
		Malleable Iron	Aluminum
Cast Covers — Weatherproof — With gasket and stainless steel screws			
	For external operation of tumbler switches with square handles	FSK-2VTS	FSK-2VTS-A
	Blank Cover	FSK-2B-CM	FSK-2B-CA
	Gasket — Replacement Neoprene — for use with 2-gang cast covers above	FS-GKR-2N	—

Fittings

FITTINGS: CAST DEVICE BOXES

FS and FD Two Gang and Cast Hub Device Box Wiring Capacity and Dimensions

Wiring Capacity

Hub Size (inches)	Capacity (in ³ /dm ³)	
	FS	FD
1/2	32.00/0.52	45.00/0.74
3/4	32.00/0.52	45.00/0.74
1	32.00/0.52	45.00/0.74

Dimensions



Hub Size (inches)	Dimensions in Inches/Millimeters							
	A	B	C	D		E	F	
				"FS"	"FD"		"FS"	"FD"
1/2	5.88/149.4	1.13/28.7	0.63/16.0	2.00/50.8	2.69/68.3	1.88/47.8	1.78/45.2	2.44/62.0
3/4	5.88/149.4	1.38/35.1	0.75/19.1	2.00/50.8	2.69/68.3	1.88/47.8	1.78/45.2	2.44/62.0
1	6.31/160.3	1.69/42.9	0.94/23.9	2.00/50.8	2.69/68.3	2.06/52.3	1.78/45.2	2.44/62.0



Fittings

FITTINGS: CAST DEVICE BOXES





FS Three Gang Cast Device Boxes and Stamped and Cast Covers for Ridge Top Boxes

UNILETS® for use with Threaded Rigid Metal Conduit and IMC. Furnished with Internal Ground Screw.

Three Gang Cast Device Boxes

	Type	Depth	Hub Size (Inches)	Catalog Number Malleable Iron Ridge Top
	FS	Shallow	3/4	FS-3-75
			1	FS-3-100
	FSS	Shallow	3/4	FSS-3-75

Cast Device Covers

	Description	Catalog Number
Stamped Steel Covers – Furnished with stainless steel screws, less gasket		
	For square handle tumbler or toggle flush switches	FSK-3TS
	Blank Cover	FSK-3B
Malleable Iron Cast Covers – Weatherproof – Furnished with gasket and stainless steel screws		
	Blank Cast Cover	FSK-3B-CM
Gasket – Replacement		
	Neoprene – for use with 3-gang covers above	FS-GKR-3N

Fittings

FITTINGS: CAST DEVICE BOXES

FS Three Gang Cast Device Box Wiring Capacity and Dimensions

Wiring Capacity

Hub Size (inches)	Capacity (in ³ /dm ³) FS
1/2	40.00/0.66
3/4	40.00/0.66
1	40.00/0.66

Dimensions in Inches/Millimeters



Hub Size (inches)	Dimensions in Inches/Millimeters					
	A	B	C	D	E	F
1/2	5.88/149.4	1.13/28.7	0.63/16.0	2.00/50.8	1.88/47.8	1.78/45.2
3/4	5.88/149.4	1.38/35.1	0.75/19.1	2.00/50.8	1.88/47.8	1.78/45.2
1	6.31/190.3	1.69/42.9	0.94/23.9	2.00/50.8	2.13/54.1	1.78/45.2

Fittings

FITTINGS: CAST DEVICE BOXES