

GR and GRF Conduit Outlet Boxes

Explosionproof, Dust-Ignitionproof

UNILETS® for use with Threaded Metal Conduit. Furnished with Internal Ground Screw and O-Ring.

Class I, Division 1 and 2, Groups B♦, C, D
Class II, Division 1 and 2, Groups E, F, G
Class III
NEMA 3, 4

Applications

- Complies with a wide range of classified area requirements.
- Corrosion-resistant: ideal indoors or out.
- For pulling of wires.
- Connect conduit lengths and change direction of conduit runs.
- Provide access for maintenance.

Features

- GR boxes offers ten hub arrangements.
- GRF boxes have integral mounting flange.
- Malleable iron bodies have high tensile strength, ductility and provides great resistance to corrosion, impact, and shock.
- Accurately tapped, tapered hub threads for tight, rigid joints and ground continuity.
- Furnished with covers.
- General purpose wiring.
- Function as sealing fittings when used with sealing covers (see NEC for restrictions).
- Internally threaded body with externally threaded cover.
- Covers have pry notches for bar or wrench.
- Accommodate sealing, dome, hub and union hub covers, and canopies.
- Standard O-rings provide raintight fit. NEMA 3, 4.
- Internal ground screw standard.
- Smooth, rounded integral bushing in each hub type box protects conductor insulation.

Standard Materials

- Body: malleable iron or copperfree (4/10 of 1% max.) aluminum
- Cover: copperfree (4/10 of 1% max.) aluminum

Standard Finishes

- Malleable iron bodies and covers: triple-coat — (1) zinc electroplate, (2) chromate, and (3) epoxy powder coat
- Aluminum bodies and covers: epoxy powder coat

Options

- To order body without cover, add suffix **-LC** to catalog number.
- For malleable iron body and cover, add suffix **-M**.
- PVC coating available on specified products. Add suffix **-PVC** to catalog number. To add PVC coating to items not specified, contact your local sales representative.

Certifications and Compliances

- Class 1, Zone 1 & 2 IIA & IIB
- UL Listed: E10444
- CSA Standard: C22.2 No. 25, C22.2 No. 30
- CSA Certified: 013017



♦ In Class I, Division 1, Group B atmospheres, all conduit runs must have a sealing fitting (not supplied) field-installed adjacent to the enclosure.

GR Conduit Outlet Boxes







Explosionproof, Dust-Ignitionproof

UNILETS® for use with Threaded Metal Conduit. Furnished with Internal Ground Screw and O-Ring.

Class I, Division 1 and 2, Groups B♦, C, D
 Class II, Division 1 and 2, Groups E, F, G
 Class III
 NEMA 3, 4

Enclosures and Junction Boxes

ENCLOSURES AND JUNCTION BOXES: HAZARDOUS LOCATION CONDUIT OUTLET BOXES

Hub Type	Conduit Size (Inches)	Cover Opening Inches/Millimeters	Volume Capacity in ³ /dm ³	Form Number ^③	Catalog Number ^①	
					Malleable Iron ^② Body With Aluminum Cover	Aluminum Body with Aluminum Cover
	1/2	3.38/85.9	18.0/.29	1	GRE50	GRE50-A
	3/4	3.38/85.9	18.0/.29	1	GRE75	GRE75-A
	1	3.38/85.9	18.0/.29	1	GRE100	GRE100-A
	1-1/4	3.94/100.1	31.0/.51	2	GRE125	GRE125-A
	1-1/2	4.88/124.0	72.0/1.18	3	GRE150	GRE150-A
	1/2	3.38/85.9	18.0/.29	1	GRC50	GRC50-A
	3/4	3.38/85.9	18.0/.29	1	GRC75	GRC75-A
	1	3.38/85.9	18.0/.29	1	GRC100	GRC100-A
	1-1/4	3.94/100.1	31.0/.51	2	GRC125	GRC125-A
	1-1/2	4.88/124.0	72.0/1.18	3	GRC150	GRC150-A
	2	4.88/124.0	76.0/1.25	3	GRC200	GRC200-A
	1/2	3.38/85.9	18.0/.29	1	GRL50	GRL50-A
	3/4	3.38/85.9	18.0/.29	1	GRL75	GRL75-A
	1	3.38/85.9	18.0/.29	1	GRL100	GRL100-A
	1-1/4	3.94/100.1	31.0/.51	2	GRL125	GRL125-A
	1-1/2	4.88/124.0	72.0/1.18	3	GRL150	GRL150-A
	2	4.88/124.0	76.0/1.25	3	GRL200	GRL200-A
	1/2	3.38/85.9	18.0/.29	1	GRLB50	GRLB50-A
	3/4	3.38/85.9	18.0/.29	1	GRLB75	GRLB75-A
	1	3.38/85.9	18.0/.29	1	GRLB100	GRLB100-A
	1-1/4	3.94/100.1	31.0/.51	2	GRLB125	GRLB125-A
	1-1/2	4.88/124.0	72.0/1.18	3	GRLB150	GRLB150-A
	2	4.88/124.0	76.0/1.25	3	GRLB200	GRLB200-A
	1/2	3.38/85.9	18.0/.29	1	GRN50	GRN50-A
	3/4	3.38/85.9	18.0/.29	1	GRN75	GRN75-A
	1	3.38/85.9	18.0/.29	1	GRN100	GRN100-A
	1-1/4	3.94/100.1	31.0/.51	2	GRN125	GRN125-A
	1-1/2	4.88/124.0	72.0/1.18	3	GRN150	GRN150-A
	1/2	3.38/85.9	18.0/.29	1	GRT50	GRT50-A
	3/4	3.38/85.9	18.0/.29	1	GRT75	GRT75-A
	1	3.38/85.9	18.0/.29	1	GRT100	GRT100-A
	1-1/4	3.94/100.1	31.0/.51	2	GRT125	GRT125-A
	1-1/2	4.88/124.0	72.0/1.18	3	GRT150	GRT150-A
	2	4.88/124.0	76.0/1.25	3	GRT200	GRT200-A
	1/2	3.38/85.9	18.0/.29	1	GRX50	GRX50-A
	3/4	3.38/85.9	18.0/.29	1	GRX75	GRX75-A
	1	3.38/85.9	18.0/.29	1	GRX100	GRX100-A
	1-1/4	3.94/100.1	31.0/.51	2	GRX125	GRX125-A
	1-1/2	4.88/124.0	72.0/1.18	3	GRX150	GRX150-A
	2	4.88/124.0	76.0/1.25	3	GRX200	GRX200-A

♦ In Class I, Division 1, Group B atmospheres, all conduit runs must have a sealing fitting (not supplied) field-installed adjacent to the enclosure.

① Other covers available—see GR and GRF Conduit Outlet Box Covers page. Order separately.

② For malleable iron body and cover, add suffix **-M**.

③ Form number designates body and matching cover sizes. To order body without cover, add suffix **-LC** to catalog number.

④ PVC coating available, add suffix **-PVC** to catalog number.

GR Conduit Outlet Boxes

Explosionproof, Dust-Ignitionproof

UNILETS® for use with Threaded Metal Conduit. Furnished with Internal Ground Screw and O-Ring.

Class I, Division 1 and 2, Groups B♦, C, D
 Class II, Division 1 and 2, Groups E, F, G
 Class III
 NEMA 3, 4

Hub Type	Conduit Size (Inches)	Cover Opening Inches/Millimeters	Volume Capacity in ³ /dm ³	Form Number ③	Catalog Number ①	
					Malleable Iron ② Body With Aluminum Cover	Aluminum Body with Aluminum Cover
	1/2	3.38/85.9	18.0/0.29	1	GRCA50	GRCA50-A
	3/4	3.38/85.9	18.0/0.29	1	GRCA75	GRCA75-A
	1/2	3.38/85.9	18.0/0.29	1	GRLA50	GRLA50-A
	3/4	3.38/85.9	18.0/0.29	1	GRLA75	GRLA75-A
	1/2	3.38/85.9	18.0/0.29	1	GRTA50	GRTA50-A
	3/4	3.38/85.9	18.0/0.29	1	GRTA75	GRTA75-A

Dimensions

Hub Size (Inches)	Dimensions in Inches/Millimeters						
	A	B	C	D	E	F	G
GR Series, Form 1							
1/2	3.75/95.3	2.44/62	2.88/73.2	0.75/19.1	0.81/20.6	2.25/57.2	1.25/31.8
3/4	3.75/95.3	2.44/62	2.88/73.2	0.75/19.1	0.81/20.6	2.25/57.2	1.25/31.8
1	3.75/95.3	2.44/62	2.88/73.2	0.94/23.9	0.94/23.9	2.25/57.2	1.06/26.9
GR Series, Forms 2 and 3							
1-1/4	4.50/114.3	2.69/68.3	3.56/90.4	1.19/30.2	0.88/22.4	2.75/69.9	1.13/28.7
1-1/2	5.75/146.1	3.75/95.3	4.81/122.2	1.38/35.1	0.94/23.9	4.06/103.1	1.50/38.1
2	5.75/146.1	4.00/101.6	5.06/128.5	1.63/41.4	1/25.4	4.25/108.0	1.25/31.8





♦ In Class I, Division 1, Group B atmospheres, all conduit runs must have a sealing fitting (not supplied) field-installed adjacent to the enclosure.
 ① Other covers available—see GR and GRF Conduit Outlet Box Covers page. Order separately.
 ② For malleable iron body and cover, add suffix **-M**.
 ③ Form number designates body and matching cover sizes. To order body without cover, add suffix **-LC** to catalog number.

GRF Flanged Conduit Outlet Boxes

Explosionproof, Dust-Ignitionproof

UNILETS® for use with Threaded Metal Conduit. Furnished with Internal Ground Screw and O-Ring.

Class I, Division 1 and 2, Groups B♦, C, D
 Class II, Division 1 and 2, Groups E, F, G
 Class III
 NEMA 3, 4

Enclosures and Junction Boxes

ENCLOSURES AND JUNCTION BOXES: HAZARDOUS LOCATION CONDUIT OUTLET BOXES

	Hub Type	Conduit Size (Inches)	Cover Opening Inches/Millimeters	Capacity in ³ /dm ³	Form Number ③	Catalog Number ①	
						Malleable Iron ② Body With Aluminum Cover	Aluminum Body with Aluminum Cover
	GRFC	1/2	3.38/85.9	18.0/0.29	1	GRFC50	GRFC50-A
		3/4	3.38/85.9	18.0/0.29	1	GRFC75	GRFC75-A
		1	3.38/85.9	18.0/0.29	1	GRFC100	GRFC100-A
	GRFL	1/2	3.38/85.9	18.0/0.29	1	GRFL50	GRFL50-A
		3/4	3.38/85.9	18.0/0.29	1	GRFL75	GRFL75-A
		1	3.38/85.9	18.0/0.29	1	GRFL100	GRFL100-A
	GRFT	1/2	3.38/85.9	18.0/0.29	1	GRFT50	GRFT50-A
		3/4	3.38/85.9	18.0/0.29	1	GRFT75	GRFT75-A
		1	3.38/85.9	18.0/0.29	1	GRFT100	GRFT100-A
	GRFX	1/2	3.38/85.9	18.0/0.29	1	GRFX50	GRFX50-A
		3/4	3.38/85.9	18.0/0.29	1	GRFX75	GRFX75-A
		1	3.38/85.9	18.0/0.29	1	GRFX100	GRFX100-A

Dimensions



♦ In Class I, Division 1, Group B atmospheres, all conduit runs must have a sealing fitting (not supplied) field-installed adjacent to the enclosure.

① Other covers available—see GR and GRF Conduit Outlet Box Covers page. Order separately

② For malleable iron body and cover, add suffix **-M**.

③ Form number designates body and matching cover sizes. To order body without cover, add suffix **-LC** to catalog number.

GR and GRF Conduit Outlet Box Covers

Explosionproof, Dust-Ignitionproof

Covers and O-rings Fit Bodies with Corresponding Form Numbers.

Class I, Division 1 and 2, Groups B♦, C, D
 Class II, Division 1 and 2, Groups E, F, G
 Class III
 NEMA 3, 4

	Hub Type	Cover Opening Inches/Millimeters	Fixture Stem Size Inches/Millimeters	Form Number ①	Catalog Number	
					Malleable Iron	Aluminum
	Surface ②	3.38/85.9		1	GRK-1M	GRK-1
		3.94/100.1		2	GRK-2M	GRK-2
		4.88/124.0		3	GRK-3M	GRK-3
	Sealing ②	3.38/85.9		1	GRK-1SC	GRK-1SC-A
		3.94/100.1		2	GRK-2SC	GRK-2SC-A
		4.88/124.0		3	GRK-3SC	GRK-3SC-A
	2" Deep Dome <i>UL Listed: E185964</i>	3.38/85.9		1	—	GRK-1DC
	Union Hub	3.38/85.9	0.75/19.1	1	GRK-75U	GRK-75UA
	Hub	3.38/85.9	0.50/12.7	1	GRK-50	GRK50-A
		3.38/85.9	0.75/19.1	1	GRK-75	GRK75-A
	Canopy Length 4-1/2"	3.38/85.9	0.50/12.7	1	GRK-50C	—
		3.38/85.9	0.75/19.1	1	GRK-75C	—
		3.38/85.9	1.00/25.4	1	GRK-100C	—
					Catalog Number	
	O-Rings — Buna-N					
	Provide Raintight fit when used on following series: GR (Forms 1, 2 and 3), GRF (Form 1), GRH, and GRU (Form 1).			1	GRG-1	
				2	GRG-2	
			3	GRG-3		
GRTB Terminal Strip						
<i>For use in standard GR series boxes Weidmuller type MK terminal block ③ with wire range of #22-#12 AWG. Mounts on 2 predrilled and tapped standard holes (furnished in internal GR boxes).</i>						
	6 position terminal block kit			1+2	GRTB6-12	
	6 position terminal block kit			3	GRTB6-3	
	12 position terminal block kit			3	GRTB12-3	

♦ In Class I, Division 1, Group B atmospheres, all conduit runs must have a sealing fitting (not supplied) field-installed adjacent to the enclosure.

① Form numbers designate cover and matching body sizes.

② PVC coating available, add suffix **-PVC** to catalog number.

③ Terminal block is UL listed for 300 Volt, 25 Amp. CSA certified for 300 Volt, 13 Amp.

GR and GRF Conduit Outlet Boxes

Explosionproof, Dust-Ignitionproof

UNILETS® for use with Threaded Metal Conduit. Furnished with Internal Ground Screw and O-Ring.

Class I, Division 1 and 2, Groups B♦, C, D
Class II, Division 1 and 2, Groups E, F, G
Class III
NEMA 3, 4

Applications

- Complies with a wide range of classified area requirements.
- Corrosion-resistant: ideal indoors or out.
- For pulling of wires.
- Connect conduit lengths and change direction of conduit runs.
- Provide access for maintenance.

Features

- GR boxes offers ten hub arrangements.
- GRF boxes have integral mounting flange.
- Malleable iron bodies have high tensile strength, ductility and provides great resistance to corrosion, impact, and shock.
- Accurately tapped, tapered hub threads for tight, rigid joints and ground continuity.
- Furnished with covers.
- General purpose wiring.
- Function as sealing fittings when used with sealing covers (see NEC for restrictions).
- Internally threaded body with externally threaded cover.
- Covers have pry notches for bar or wrench.
- Accommodate sealing, dome, hub and union hub covers, and canopies.
- Standard O-rings provide raintight fit. NEMA 3, 4.
- Internal ground screw standard.
- Smooth, rounded integral bushing in each hub type box protects conductor insulation.

Standard Materials

- Body: malleable iron or copperfree (4/10 of 1% max.) aluminum
- Cover: copperfree (4/10 of 1% max.) aluminum

Standard Finishes

- Malleable iron bodies and covers: triple-coat — (1) zinc electroplate, (2) chromate, and (3) epoxy powder coat
- Aluminum bodies and covers: epoxy powder coat

Options

- To order body without cover, add suffix **-LC** to catalog number.
- For malleable iron body and cover, add suffix **-M**.
- PVC coating available on specified products. Add suffix **-PVC** to catalog number. To add PVC coating to items not specified, contact your local sales representative.

Certifications and Compliances

- Class 1, Zone 1 & 2 IIA & IIB
- UL Listed: E10444
- CSA Standard: C22.2 No. 25, C22.2 No. 30
- CSA Certified: 013017



♦ In Class I, Division 1, Group B atmospheres, all conduit runs must have a sealing fitting (not supplied) field-installed adjacent to the enclosure.

GR Conduit Outlet Boxes







Explosionproof, Dust-Ignitionproof

UNILETS® for use with Threaded Metal Conduit. Furnished with Internal Ground Screw and O-Ring.

Class I, Division 1 and 2, Groups B♦, C, D
 Class II, Division 1 and 2, Groups E, F, G
 Class III
 NEMA 3, 4

Enclosures and Junction Boxes

ENCLOSURES AND JUNCTION BOXES: HAZARDOUS LOCATION CONDUIT OUTLET BOXES

	Hub Type	Conduit Size (Inches)	Cover Opening Inches/Millimeters	Volume Capacity in ³ /dm ³	Form Number ^③	Catalog Number ^①	
						Malleable Iron ^② Body With Aluminum Cover	Aluminum Body with Aluminum Cover
	GRE	1/2	3.38/85.9	18.0/29	1	GRE50	GRE50-A
		3/4	3.38/85.9	18.0/29	1	GRE75	GRE75-A
		1	3.38/85.9	18.0/29	1	GRE100	GRE100-A
		1-1/4	3.94/100.1	31.0/51	2	GRE125	GRE125-A
		1-1/2	4.88/124.0	72.0/1.18	3	GRE150	GRE150-A
	GRC ^④	1/2	3.38/85.9	18.0/29	1	GRC50	GRC50-A
		3/4	3.38/85.9	18.0/29	1	GRC75	GRC75-A
		1	3.38/85.9	18.0/29	1	GRC100	GRC100-A
		1-1/4	3.94/100.1	31.0/51	2	GRC125	GRC125-A
		1-1/2	4.88/124.0	72.0/1.18	3	GRC150	GRC150-A
		2	4.88/124.0	76.0/1.25	3	GRC200	GRC200-A
	GRL ^④	1/2	3.38/85.9	18.0/29	1	GRL50	GRL50-A
		3/4	3.38/85.9	18.0/29	1	GRL75	GRL75-A
		1	3.38/85.9	18.0/29	1	GRL100	GRL100-A
		1-1/4	3.94/100.1	31.0/51	2	GRL125	GRL125-A
		1-1/2	4.88/124.0	72.0/1.18	3	GRL150	GRL150-A
		2	4.88/124.0	76.0/1.25	3	GRL200	GRL200-A
			GRLB ^④	1/2	3.38/85.9	18.0/29	1
3/4	3.38/85.9			18.0/29	1	GRLB75	GRLB75-A
1	3.38/85.9			18.0/29	1	GRLB100	GRLB100-A
1-1/4	3.94/100.1			31.0/51	2	GRLB125	GRLB125-A
1-1/2	4.88/124.0			72.0/1.18	3	GRLB150	GRLB150-A
2	4.88/124.0			76.0/1.25	3	GRLB200	GRLB200-A
	GRN ^④	1/2	3.38/85.9	18.0/29	1	GRN50	GRN50-A
		3/4	3.38/85.9	18.0/29	1	GRN75	GRN75-A
		1	3.38/85.9	18.0/29	1	GRN100	GRN100-A
		1-1/4	3.94/100.1	31.0/51	2	GRN125	GRN125-A
		1-1/2	4.88/124.0	72.0/1.18	3	GRN150	GRN150-A
	GRT ^④	1/2	3.38/85.9	18.0/29	1	GRT50	GRT50-A
		3/4	3.38/85.9	18.0/29	1	GRT75	GRT75-A
		1	3.38/85.9	18.0/29	1	GRT100	GRT100-A
		1-1/4	3.94/100.1	31.0/51	2	GRT125	GRT125-A
		1-1/2	4.88/124.0	72.0/1.18	3	GRT150	GRT150-A
		2	4.88/124.0	76.0/1.25	3	GRT200	GRT200-A
	GRX ^④	1/2	3.38/85.9	18.0/29	1	GRX50	GRX50-A
		3/4	3.38/85.9	18.0/29	1	GRX75	GRX75-A
		1	3.38/85.9	18.0/29	1	GRX100	GRX100-A
		1-1/4	3.94/100.1	31.0/51	2	GRX125	GRX125-A
		1-1/2	4.88/124.0	72.0/1.18	3	GRX150	GRX150-A
		2	4.88/124.0	76.0/1.25	3	GRX200	GRX200-A

♦ In Class I, Division 1, Group B atmospheres, all conduit runs must have a sealing fitting (not supplied) field-installed adjacent to the enclosure.

① Other covers available—see GR and GRF Conduit Outlet Box Covers page. Order separately.

② For malleable iron body and cover, add suffix **-M**.

③ Form number designates body and matching cover sizes. To order body without cover, add suffix **-LC** to catalog number.

④ PVC coating available, add suffix **-PVC** to catalog number.

GR Conduit Outlet Boxes

Explosionproof, Dust-Ignitionproof

UNILETS® for use with Threaded Metal Conduit. Furnished with Internal Ground Screw and O-Ring.

Class I, Division 1 and 2, Groups B♦, C, D
 Class II, Division 1 and 2, Groups E, F, G
 Class III
 NEMA 3, 4

Hub Type	Conduit Size (Inches)	Cover Opening Inches/Millimeters	Volume Capacity in ³ /dm ³	Form Number ③	Catalog Number ①	
					Malleable Iron ② Body With Aluminum Cover	Aluminum Body with Aluminum Cover
	1/2	3.38/85.9	18.0/0.29	1	GRCA50	GRCA50-A
	3/4	3.38/85.9	18.0/0.29	1	GRCA75	GRCA75-A
	1/2	3.38/85.9	18.0/0.29	1	GRLA50	GRLA50-A
	3/4	3.38/85.9	18.0/0.29	1	GRLA75	GRLA75-A
	1/2	3.38/85.9	18.0/0.29	1	GRTA50	GRTA50-A
	3/4	3.38/85.9	18.0/0.29	1	GRTA75	GRTA75-A

Dimensions

Hub Size (Inches)	Dimensions in Inches/Millimeters						
	A	B	C	D	E	F	G
GR Series, Form 1							
1/2	3.75/95.3	2.44/62	2.88/73.2	0.75/19.1	0.81/20.6	2.25/57.2	1.25/31.8
3/4	3.75/95.3	2.44/62	2.88/73.2	0.75/19.1	0.81/20.6	2.25/57.2	1.25/31.8
1	3.75/95.3	2.44/62	2.88/73.2	0.94/23.9	0.94/23.9	2.25/57.2	1.06/26.9
GR Series, Forms 2 and 3							
1-1/4	4.50/114.3	2.69/68.3	3.56/90.4	1.19/30.2	0.88/22.4	2.75/69.9	1.13/28.7
1-1/2	5.75/146.1	3.75/95.3	4.81/122.2	1.38/35.1	0.94/23.9	4.06/103.1	1.50/38.1
2	5.75/146.1	4.00/101.6	5.06/128.5	1.63/41.4	1/25.4	4.25/108.0	1.25/31.8





♦ In Class I, Division 1, Group B atmospheres, all conduit runs must have a sealing fitting (not supplied) field-installed adjacent to the enclosure.
 ① Other covers available—see GR and GRF Conduit Outlet Box Covers page. Order separately.
 ② For malleable iron body and cover, add suffix **-M**.
 ③ Form number designates body and matching cover sizes. To order body without cover, add suffix **-LC** to catalog number.

GRF Flanged Conduit Outlet Boxes

Explosionproof, Dust-Ignitionproof

UNILETS® for use with Threaded Metal Conduit. Furnished with Internal Ground Screw and O-Ring.

Class I, Division 1 and 2, Groups B♦, C, D
 Class II, Division 1 and 2, Groups E, F, G
 Class III
 NEMA 3, 4

Enclosures and Junction Boxes

ENCLOSURES AND JUNCTION BOXES: HAZARDOUS LOCATION CONDUIT OUTLET BOXES

	Hub Type	Conduit Size (Inches)	Cover Opening Inches/Millimeters	Capacity in ³ /dm ³	Form Number ③	Catalog Number ①	
						Malleable Iron ② Body With Aluminum Cover	Aluminum Body with Aluminum Cover
	GRFC	1/2	3.38/85.9	18.0/0.29	1	GRFC50	GRFC50-A
		3/4	3.38/85.9	18.0/0.29	1	GRFC75	GRFC75-A
		1	3.38/85.9	18.0/0.29	1	GRFC100	GRFC100-A
	GRFL	1/2	3.38/85.9	18.0/0.29	1	GRFL50	GRFL50-A
		3/4	3.38/85.9	18.0/0.29	1	GRFL75	GRFL75-A
		1	3.38/85.9	18.0/0.29	1	GRFL100	GRFL100-A
	GRFT	1/2	3.38/85.9	18.0/0.29	1	GRFT50	GRFT50-A
		3/4	3.38/85.9	18.0/0.29	1	GRFT75	GRFT75-A
		1	3.38/85.9	18.0/0.29	1	GRFT100	GRFT100-A
	GRFX	1/2	3.38/85.9	18.0/0.29	1	GRFX50	GRFX50-A
		3/4	3.38/85.9	18.0/0.29	1	GRFX75	GRFX75-A
		1	3.38/85.9	18.0/0.29	1	GRFX100	GRFX100-A

Dimensions



♦ In Class I, Division 1, Group B atmospheres, all conduit runs must have a sealing fitting (not supplied) field-installed adjacent to the enclosure.

① Other covers available—see GR and GRF Conduit Outlet Box Covers page. Order separately

② For malleable iron body and cover, add suffix **-M**.









③ Form number designates body and matching cover sizes. To order body without cover, add suffix **-LC** to catalog number.

GR and GRF Conduit Outlet Box Covers

Explosionproof, Dust-Ignitionproof

Covers and O-rings Fit Bodies with Corresponding Form Numbers.

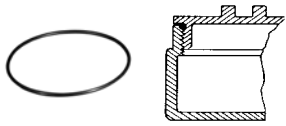
Class I, Division 1 and 2, Groups B♦, C, D
 Class II, Division 1 and 2, Groups E, F, G
 Class III
 NEMA 3, 4

	Hub Type	Cover Opening Inches/Millimeters	Fixture Stem Size Inches/Millimeters	Form Number ①	Catalog Number	
					Malleable Iron	Aluminum
	Surface ②	3.38/85.9		1	GRK-1M	GRK-1
		3.94/100.1		2	GRK-2M	GRK-2
		4.88/124.0		3	GRK-3M	GRK-3
	Sealing ②	3.38/85.9		1	GRK-1SC	GRK-1SC-A
		3.94/100.1		2	GRK-2SC	GRK-2SC-A
		4.88/124.0		3	GRK-3SC	GRK-3SC-A
	2" Deep Dome <i>UL Listed: E185964</i>	3.38/85.9		1	—	GRK-1DC
	Union Hub	3.38/85.9	0.75/19.1	1	GRK-75U	GRK-75UA
	Hub	3.38/85.9	0.50/12.7	1	GRK-50	GRK50-A
		3.38/85.9	0.75/19.1	1	GRK-75	GRK75-A
	Canopy Length 4-1/2"	3.38/85.9	0.50/12.7	1	GRK-50C	—
		3.38/85.9	0.75/19.1	1	GRK-75C	—
		3.38/85.9	1.00/25.4	1	GRK-100C	—
					Catalog Number	
	O-Rings — Buna-N					
	Provide Raintight fit when used on following series: GR (Forms 1, 2 and 3), GRF (Form 1), GRH, and GRU (Form 1).			1	GRG-1	
				2	GRG-2	
			3	GRG-3		
GRTB Terminal Strip						
<i>For use in standard GR series boxes Weidmuller type MK terminal block ③ with wire range of #22-#12 AWG. Mounts on 2 predrilled and tapped standard holes (furnished in internal GR boxes).</i>						
	6 position terminal block kit			1+2	GRTB6-12	
	6 position terminal block kit			3	GRTB6-3	
	12 position terminal block kit			3	GRTB12-3	

♦ In Class I, Division 1, Group B atmospheres, all conduit runs must have a sealing fitting (not supplied) field-installed adjacent to the enclosure.

① Form numbers designate cover and matching body sizes.

② PVC coating available, add suffix **-PVC** to catalog number.

③ Terminal block is UL listed for 300 Volt, 25 Amp. CSA certified for 300 Volt, 13 Amp.