

HMI VU Series Instruction Leaflet

Contents

	Page
Description.....	
Preface	1
Safety Precautions.....	1
Installation.....	3
Wiring	4
Basic Inspection.....	4
Hardware Features	7
Panel Cut-Out.....	17
Specifications.....	19

Preface

Thank you for purchasing Eaton's HMi VU series operator interface. This quick start guide will be helpful in the installation, wiring and inspection of your Eaton operator interface. Before using the product, please read this quick start guide to ensure correct use. You should thoroughly understand all safety precautions before proceeding with the installation, wiring and operation. Please observe the following precautions:

- Install the product in a clean and dry location free from corrosive and flammable gases or liquids.
- Ensure that all wiring instructions and recommendations are followed.
- Ensure that the operator interface is correctly connected to a ground. The grounding method must comply with the electrical standard for the country of final installation (NFPA 70: National Electrical Code, 2005 Ed).
- Do not modify or remove wiring when power is applied to the operator interface.
- Do not touch the power supply during operation or it may cause electric shock.
- For the information on HMiSoft installation and use, please refer to the HMiSoft manual at www.eaton.com/oj.

If you have any questions during operation, please contact an authorized local distributor or Eaton sales representative. The content of this quick start guide may be revised without notice. Please consult an authorized distributor or download the most up to date version at www.eaton.com/oj.

Safety Precautions

Carefully note and observe the following safety precautions when receiving, inspecting, installing, operating, maintaining and troubleshooting. The following words, DANGER, WARNING and STOP are used to mark safety precautions when using Eaton's operator interface. Failure to observe these precautions may void the warranty!

Installation

- 
- Do not install the product in a location that is outside the stated specification for the operator interface. Failure to observe this caution may result in an electric shock or fire hazard as well as damage to the unit.
 - Do not install the product in a location where temperatures will exceed specification for the operator interface. Failure to observe this caution may result in abnormal operation or damage the product.
 - Please note that this equipment has obtained EMC registration for commercial use. In the event that it has been mistakenly sold or purchased, please exchange it for equipment certified for home use.
 - Do not use this product as an alarm device for disaster early warning systems nor as a system emergency stop as it may result in personal injury and equipment damage.

Wiring

- 
- Connect the ground terminals to a class-3 ground (Ground resistance should not exceed 100Ω). Improper grounding may result in communication error, equipment damage, and electric shock or fire.

HM/VU Series Instruction Leaflet

Operation



- HMiSoft Screen Editor software is the only software authorized for creation and editing of applications to be run on Eaton's **HM/** and **HM/** VU series hardware.
- To avoid personal injury and equipment damage, the **HM/** applications should be designed so that a communication loss results in a system fail safe state.
- It is good practice to backup the **HM/** application in the event that the operator interface is damaged, the application is lost or inadvertently deleted.



- Modify wiring during operation may result in electric shock or personal injury.
- Using a sharp or pointed object to activate screen controls may result in damage to the touchscreen and improper operation.

Wiring Method



- Observe voltage specifications. Failure to do so observe this caution may result in electric shock or fire as well as damage to the unit.
- Remove the terminal block from the operator interface before wiring.
- Insert only one wire into each terminal on the terminal block.

Communication Wiring



- Comply with communication wiring and grounding specifications for the network being used.
- All power cables should be placed in separate conduits from communication cables in order to avoid noise and interference.

Maintenance and Inspection



- Electrical shock and damage to unit may result from contact with any internal electronic assemblies.
- First remove power and then disconnect the terminals to avoid electrical shock and damage to unit.
- Accessing the unit's internal electric assemblies will void the warranty. In addition, an electrical charge with hazardous voltages may reside in the operator interface after power has been removed for 10 minutes or longer which may result in electrical shock and damage to the unit.
- Turn the power off before changing backup battery and check system settings after changes are made. Note that the application and all data will be cleared after a battery change.
- Obstruction of ventilation holes during operation may result in malfunction caused by overheating.

Installation

Installation Notes

- The panel thickness should be 5 mm or less for proper mounting.

Installation Method:

Step 1:

Ensure the pre-installed waterproof gasket is present and properly aligned.

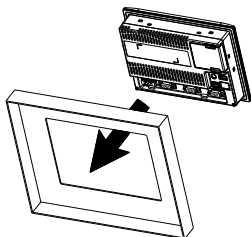

Step 2:

Insert fasteners into the operator interface slots. All should be finger tight initially.

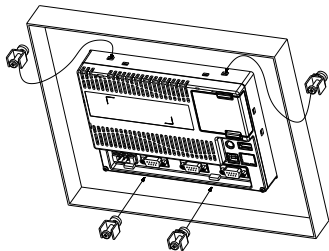

Step 3:

Torque all fasteners to 6.17lb-inch (0.7N-M)
Over torque may cause damage to the operator interface housing.

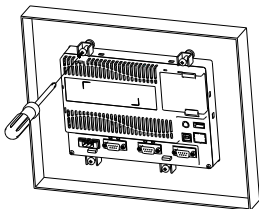

Step 4:

Maintain a minimum spacing of 60mm from the back of the operator interface ventilation holes.

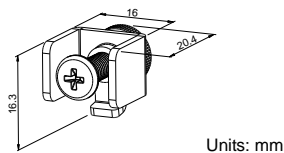
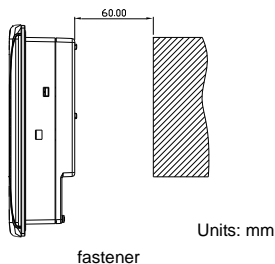

Wiring

•Please observe the following wiring notes.

- Use shielded twisted-pair cables for wiring.

Recommended wiring:

Type	Wire Gauge (AWG)	Stripped length	Torque
Solid	28 ~ 12	7 ~ 8 mm	5 kg-cm (4.3 lb-in)
Stranded	30 ~ 12	7 ~ 8 mm	5 kg-cm (4.3 lb-in)

Power supply connector:

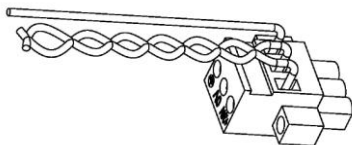

Basic Inspection

Item	Content
General Inspection	<ul style="list-style-type: none"> ■ Periodically inspect the screws of the connection between the operator interface and device. Tighten screws as necessary as they may loosen due to vibration and varying temperatures. ■ Ensure that oil, water, metallic particles or any foreign objects do not fall inside the operator interface ventilation slots and holes, as this may cause damage to the unit. ■ Ensure the enclosure is free from harmful dust, gases, and liquids.
Inspection before system operation (power not applied)	<ul style="list-style-type: none"> ■ Ensure that all wiring terminals are correctly insulated. ■ Visually check to ensure that there are no loose screws, metal shavings, and conductive or flammable materials that may fall into the operator interface.
Inspection before system operation (power is applied)	<ul style="list-style-type: none"> ■ Confirm power LED lights. ■ Confirm communication with devices.

Pin Definition for Communications

HMIVU04CUNBE

COM1 Port (Supports Flow Control)

PIN	MODE1		MODE2		MODE3	
	COM2	COM3	COM2	COM3	COM2	COM3
	RS-232	RS-485	RS-485	RS-485	RS-232	RS-422
1			D+			TXD+
2	RXD				RXD	
3	TXD				TXD	
4		D+		D+		RXD+
5	GND		GND		GND	
6			D-			TXD-
7	RTS					
8	CTS					
9		D-		D-		RXD-

Note: Blank = No Connection.

HMIVU06CUNB1 / HMIVU07CUNBE

COM1 Port (Supports Flow Control)

PIN	Contact
	RS-232
1	
2	RXD
3	TXD
4	
5	GND
6	
7	RTS
8	CTS
9	

Note: Blank = No Connection.

COM2 and COM3 Port

PIN	MODE1		MODE2		MODE3	
	COM2	COM3	COM2	COM3	COM2	COM3
	RS-232	RS-485	RS-485	RS-485	RS-232	RS-422
1			D+			TXD+
2	RXD				RXD	
3	TXD				TXD	
4		D+		D+		RXD+
5	GND		GND		GND	
6			D-			TXD-
7						
8						
9		D-		D-		RXD-

Note1: Blank = No Connection.

Note2: HMIVU06CUNB/HMIVU07CUNBE models do not support RS-422 flow control function.

HMIVU08CUNBE / HMIVU10WCUNBE

COM1 Port (Supports Flow Control)

PIN	Contact
	RS-232
1	
2	RXD
3	TXD
4	
5	GND
6	
7	RTS
8	CTS
9	

Note: Blank = No Connection.

HM_i VU Series Instruction Leaflet

COM2 Port (Supports Flow Control)

PIN	MODE1	MODE2	MODE3
	RS-232	RS-422	RS-485
1		TXD+	D+
2	RXD		
3	TXD		
4		RXD+	
5	GND	GND	GND
6		TXD-	D-
7	RTS		
8	CTS		
9		RXD-	

Note1: Blank = No Connection.

Note2: When COM2 port is used for RS-232 flow control, i.e. RTS and CTS signals are used for flow control, COM3 port will become disabled.

Note3: When COM2 port is used for RS-422 with flow control, COM3 Port pins 1, 4, 6, and 9 are used for the signals, RTS+, CTS+, RTS- and CTS- as shown in brackets.

COM3 Port

PIN	MODE1	MODE2	MODE3
	RS-232	RS-422	RS-485
1		TXD+ (RTS+)	D+
2	RXD		
3	TXD		
4		RXD+ (CTS+)	
5	GND	GND	GND
6		TXD- (RTS-)	D-
7			
8			
9		RXD- (CTS-)	

Note1: Blank = No Connection.

Note2: When COM2 port is used for RS-422 with flow control, COM3 Port pins 1, 4, 6, and 9 are used for the signals, RTS+, CTS+, RTS- and CTS- as shown in brackets.

Ethernet Port

Ethernet Port	PIN	Contact
		Ethernet
	1	TX+
	2	TX-
	3	RX+
	4	
	5	
	6	RX-
	7	
	8	

Note: Blank = No Connection.

Hardware Features

HMIVU04CUNBE (Front View)

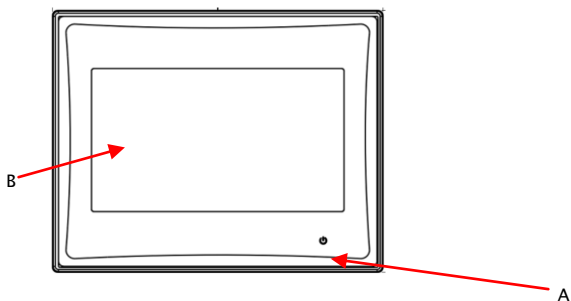



A	Power LED Indicator (Lights in green when power is applied.)
B	Touch Screen / Display

HMI VU Series Instruction Leaflet

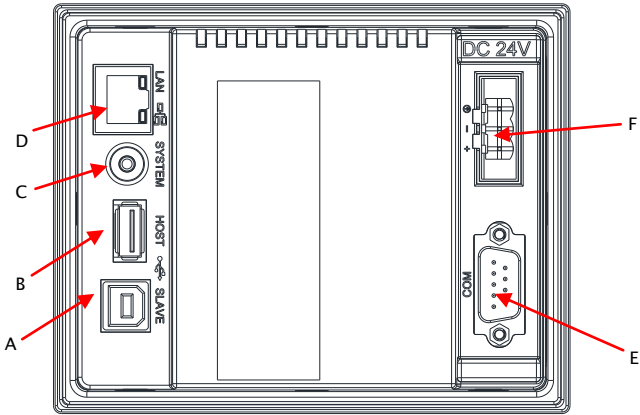
HMIVU04CUNBE (Rear View)



A	USB Slave	D	Ethernet Port
B	USB Host	E	COM1 ^(Note1)
C	System Button	F	Power Input Terminal

1. Refer to the Pin Definition for Communications section for simultaneous use of COM1 and COM2.

HM*i* VU Series Instruction Leaflet

HMIVU06CUNB1 (Front View)

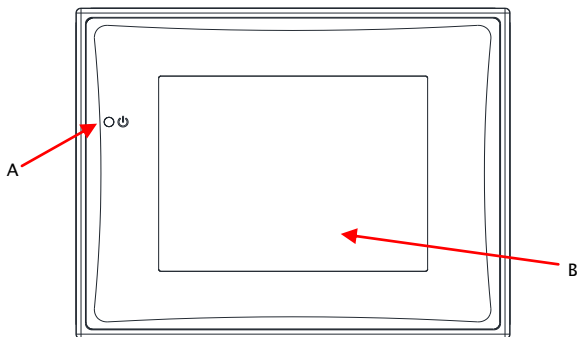

A	Power LED Indicator (Lights in green when power is applied.)
B	Touch Screen / Display

HMi VU Series Instruction Leaflet

HMIVU06CUNB 1(Rear View)

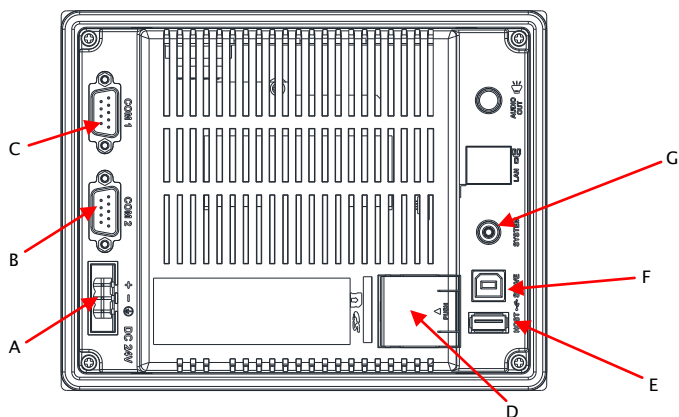

A	Power Input Terminal	E	USB Host
B	COM2 and COM3 ^(Note1)	F	USB Slave
C	COM1	G	System Button
D	Battery Cover	-	-



1. Refer to the Pin Definition for Communications section for simultaneous use of COM2 and COM3.

HM*i* VU Series Instruction Leaflet

HMIVU07CUNBE (Front View)

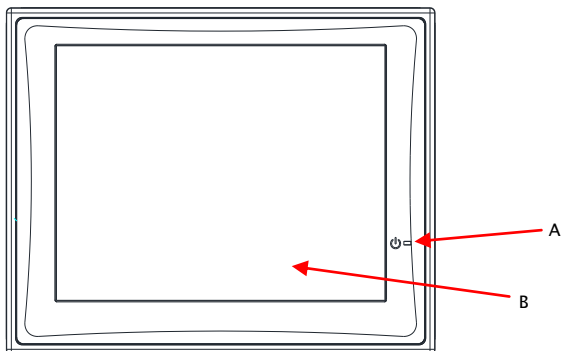

A	Power LED Indicator (Lights in green when power is applied.)
---	--

B	Touch Screen / Display
---	------------------------

HM*i* VU Series Instruction Leaflet

HMIVU07CUNBE (Rear View)

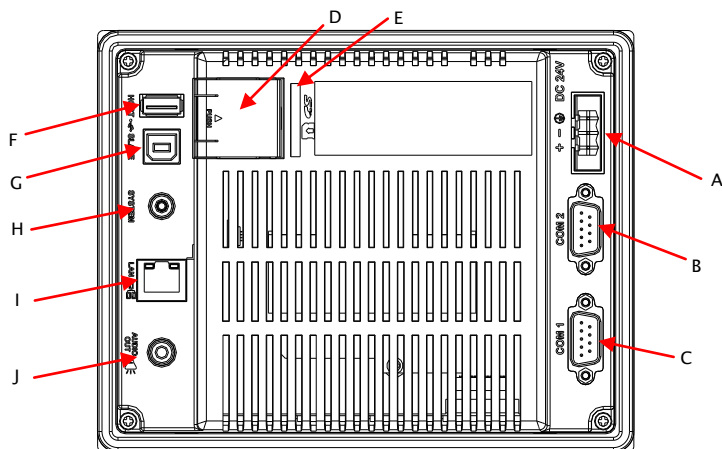

A	Power Input Terminal	F	USB Host
B	COM2 and COM3 ^(Note1)	G	USB Slave
C	COM1	H	System Button
D	Battery Cover	I	Ethernet Port
E	Memory Card Slot	J	Audio Output Port





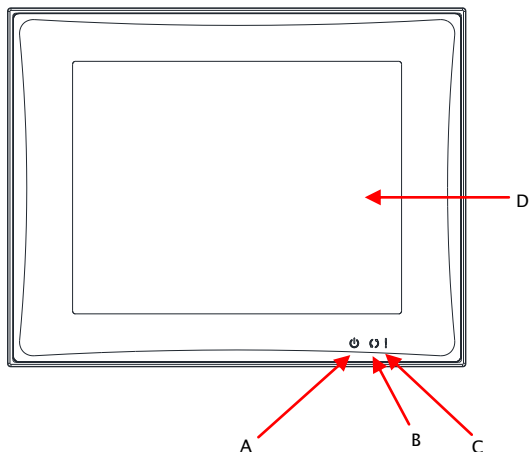

1. Refer to the Pin Definition for Communications section for simultaneous use of COM2 and COM3.

HMI VU Series Instruction Leaflet

HMIVU08CUNBE (Front View)



A	 : Power LED Indicator Lights in green when power is applied.
B	 : Operation LED Indicator (Blue) ^(Note1) The operation LED indicator blinks in blue when communicating or accessing data
C	 : Alarm LED Indicator (Red) The alarm LED indicator blinks in red when one of the alarms is on.
D	Touch Screen / Display
	
1. The function for which the Blue LED indicator lights can be selected in HMIsoft.	

HMI VU Series Instruction Leaflet

HMIVU08CUNBE (Rear View)

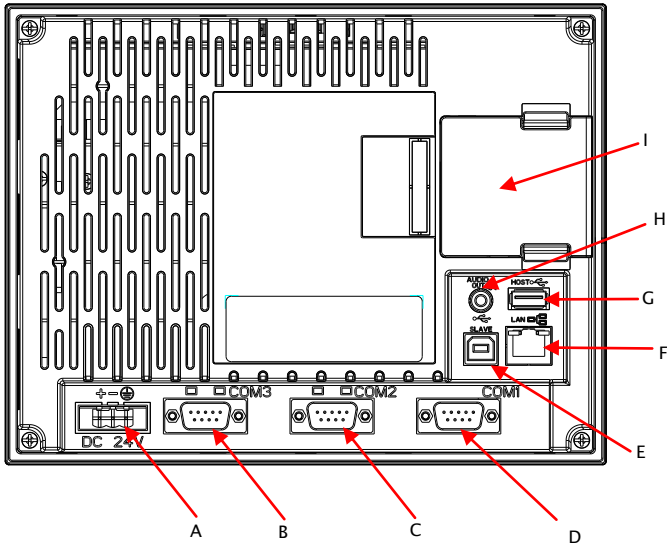



A	Power Input Terminal
B	COM3 (Two LED indicate Read or Write status during the communication process.)
C	COM2 (Two LED indicate Read or Write status during the communication process.)
D	COM1
E	USB Slave
F	Ethernet Port
G	USB Host
H	Audio Output Port
I	Memory Card Slot / Battery Cover

HMI VU Series Instruction Leaflet

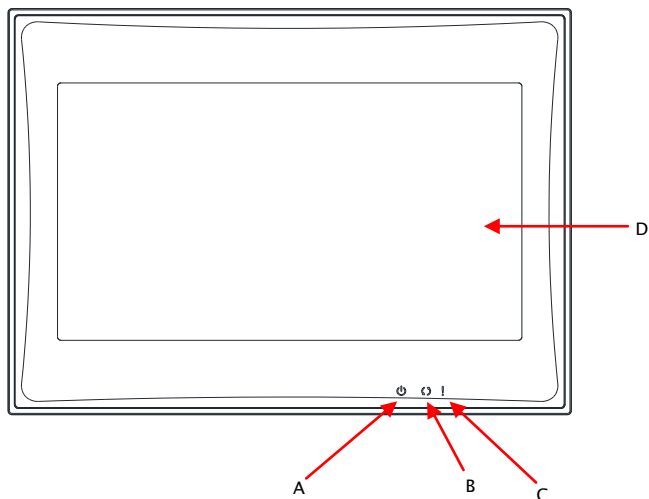
HMIVU10WCUNBE (Front View)



A	 : Power LED Indicator Lights in green when power is applied.
B	 : Operation LED Indicator (Blue) ^(Note1) The operation LED indicator blinks in blue when communicating or accessing data
C	 : Alarm LED Indicator (Red) The alarm LED indicator blinks in red when one of the alarms is on.
D	Touch Screen / Display



1. The function for which the Blue LED indicator lights can be selected in HMIsoft.

HM*i* VU Series Instruction Leaflet

HMIVU10WCUNBE (Rear View)

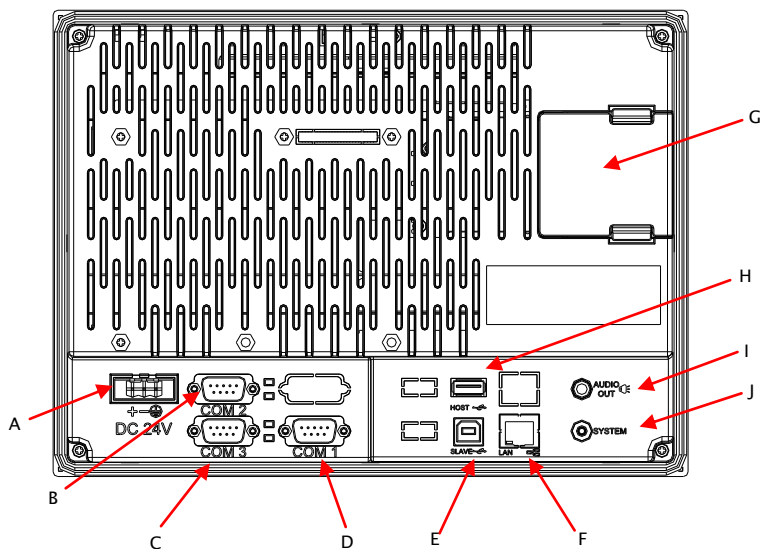

A	Power Input Terminal
B	COM2 (Two LED indicate Read or Write status during the communication process.)
C	COM3 (Two LED indicate Read or Write status during the communication process.)
D	COM1
E	USB Slave
F	Ethernet Port
G	Memory Card Slot / Battery Cover
H	USB Host
I	Audio Output Port
J	System Button

HM*i* VU Series Instruction Leaflet

Panel Cut-Out

HMIVU04CUNBE

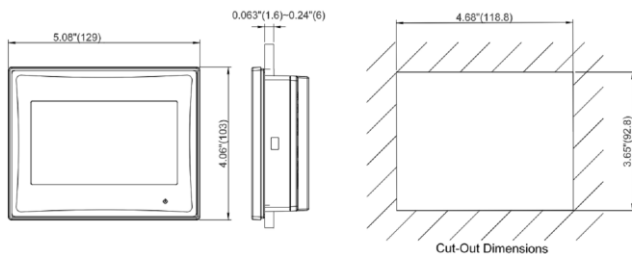

HMIVU06CUNB1

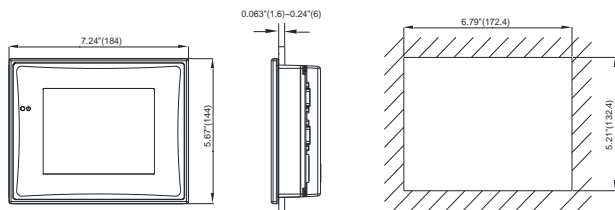

HMIVU07CUNBE

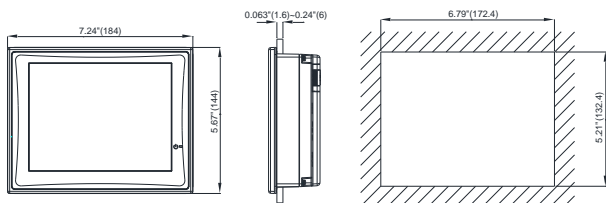

HM/VU Series Instruction Leaflet

HMIVU08CUNBE

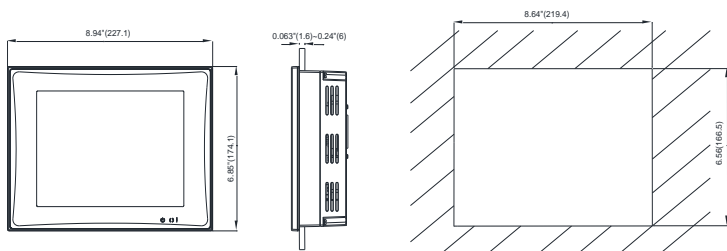

HMIVU10WCUNBE

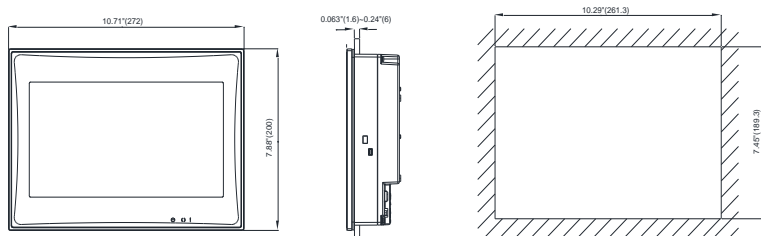

Specifications

MODEL		HMIVU04CUNBE	HMIVU06CUNB1	HMIVU07CUNBE	HMIVU08CUNBE	HMIVU10WCUNBE
LCD MODULE	Display Type	4.3" TFT LCD	5.6" TFT LCD	7" TFT LCD	8" TFT LCD	10.1" Widescreen TFT LCD
		(65536 colors)				
	Resolution	480 x 234 pixels	320 x 234 pixels	800 x 600 pixels		1024 x 600 pixels
	Backlight	LED Back Light (20,000 hours half-life at 25°C) ^(Note 1)		LED Back Light (10,000 hours half-life at 25°C) ^(Note 1)		
	Brightness NIT Rating	400 dc/m ²	200 dc/m ²	200 dc/m ²	250 dc/m ²	200 dc/m ²
Display Size	95.04 x 53.856mm	113.28 x 84.70mm	141 x 105.75mm	162 x 121.5mm	226 x 128.7mm	
Operation System		Real Time OS				
MCU		32-bit RISC Micro-controller				
NOR Flash ROM		Flash ROM 128 MB(OS System: 30MB / Backup: 16MB / User Application: 82MB)				
SDRAM		64Mbytes				
Backup Memory		16Mbytes				
Sound Effect Output	Buzzer	Multi-Tone Frequency (2K ~ 4K Hz) / 85dB				
	AUX	N/A		Stereo output		
Ethernet Interface		IEEE 802.3, IEEE 802.3u 10/100 Mbps auto-sensing has built-in isolated power circuit ^(Note 3)	N/A	IEEE 802.3, IEEE 802.3u 10/100 Mbps auto-sensing has built-in isolated power circuit ^(Note 3)		
Memory Card		N/A		SD Card (supports SDHC)		
USB		1 USB Host ^(Note 2) Ver 2.0 / 1 USB Client Ver 1.1				
Serial COM Port	COM1	RS-232 (supports hardware flow control) / RS-485	RS-232 (supports hardware flow control)			
	COM2	RS-422 / RS-485	RS-232 / RS-485		RS-232 / RS-422 / RS-485 has built-in isolated power circuit ^(Note 3)	
	COM3	N/A	RS-422 / RS-485		RS-232 / RS-422 / RS-485 has built-in isolated power circuit ^(Note 3)	

Specifications

MODEL	HMIVU04CUNBE	HMIVU06CUNB1	HMIVU07CUNBE	HMIVU08CUNBE	HMIVU10WCUNBE
Perpetual Calendar (RTC)	Built-in				
Cooling Method	Natural air circulation				
Safety Approval	CE / UL				
Waterproof Degree	IP65 / NEMA 4X (indoor use only)				
Operation Voltage <small>(Note 4)</small>	DC +24V (-10% ~ +15%) Please use isolated power supply				
Voltage Endurance	AC500V for 1 minute (between charging (DC24 terminal) and FG terminals)				
Power Consumption <small>(Note 4)</small>	4.8W	3.0W	7.68W	7.8W	12W
Backup Battery	3V lithium battery CR2032 x 1				
Backup Battery Life	It depends on the temperature used and the conditions of usage, about 3 years or more at 25°C.				
Operation Temp.	0°C ~ 50°C				
Storage Temp.	-20°C ~ +60°C				
Ambient Humidity	10% ~ 90% RH [0 ~ 40°C], 10% ~ 55% RH [41 ~ 50°C] Pollution Degree 2				
Vibration	IEC 61131-2 compliant 5Hz ≤ f < 8.3Hz = Continuous: 3.5mm, 8.3Hz ≤ f ≤ 150Hz = Continuous: 1.0g				
Shock	IEC 60068-2-27 compliant 15g peak for 11 ms duration, X, Y, Z directions for 6 times				
Dimensions (W) x (H) x (D) mm	129 x 103 x 39	184 x 144 x 50	184 x 144 x 50	227.1 x 174.1 x 61	272 x 200 x 61
Panel Cutout (W) x (H) mm	118.8 x 92.8	172.4 x 132.4	172.4 x 132.4	219.4 x 166.5	261.3 x 189.3
Weight	Approx. 264g	Approx. 670g	Approx. 800g	Approx. 1228g	Approx. 1520g



- 1) The half-life of backlight is defined as original luminance being reduced by 50% when the maximum driving current is supplied to **HM*i***. The life of LED backlight shown is an estimated value under 25°C normal temperature and humidity conditions.
- 2) USB Host port can provide up to 5V/ 500mA of power.

HMI VU Series Instruction Leaflet

- 3) The withstand voltage of the isolated power circuit is 1500V peak for 1 minute.
- 4) The value of the power consumption indicates the electrical power consumed by **HMI** only without connecting to any peripheral devices. In order to ensure the normal operation, it is recommended to use a power supply which the capacity is 1.5 ~2 times the value of the power consumption.
- 5) For further details, please visit the Eaton website www.eaton.com/electrical.

HMI VU Series Instruction Leaflet



Eaton Corporation
Electrical Group
1111 Superior Ave.
United, OH 44114
United States
877-ETN-CARE (877-386-2273)
Eaton.com

©2010 Eaton Corporation
All Rights Reserved
Printed in USA
Publication Number IL04802001E
May 2010

EAT•N
Powering Business Worldwide



PowerChain
Management®

The logo features a series of grey spheres of varying sizes arranged in a curved path, connected by a dotted line, suggesting a chain or a sequence.