

Step Lighting

For indoor and outdoor, stair and pathway applications





Juno[®] Step Lights

Offer safety, security and style

Juno Step Lights provide all the safety and security you expect in low-level lighting applications with an advanced sense of style. They are available for all your step and pathway lighting needs, from indoor to outdoor environments, from general to high-performance installations. Juno Mini LED Step Lights offer a level of aesthetics and style never before available in the category. Beautiful and unique, these exquisite fixtures are no bigger than a standard switch plate and feature apertures that are just one-inch square.

Whether your application is high performance or high style, the Juno Step Light family delivers maximum durability, functionality and economy, with light sources tailored to your exact requirements. Most fixtures are offered with state of the art LED technology that provide exceptional energy savings and – thanks to their 50,000 hour service life – greatly reduced maintenance costs. Several fixtures are available with economical CFL or incandescent lamps.

Juno Step Lights are beautifully finished and are certain to make a lasting impression. All are designed and engineered for optimum quality and performance.

Juno LED Mini Step Lights

The ultimate versatility in design

The IC-rated, all-in-one Juno LED Mini Step Light design includes the 3W LED light engine, 120-volt dimmable driver, optic and decorative face plate that all mount directly to a standard 2" x 4" junction box.



These fixtures can be mounted either vertically or horizontally in a standard 2" x 4" junction box.

Delivering modular flexibility for vertical and horizontal installations

Juno LED Mini Step Lights can be mounted in the wall either vertically or horizontally (shipped from the factory in the vertical position). Fixture orientation can be easily changed in the field.

Cutoff - Vertical Orientation

Cutoff - Horizontal Orientation

Performance Optics

Four striking optical designs satisfy a variety of illumination and aesthetic requirements.

Marker



The opal lens produces an attractive glow ideal for marking corridors or pathways.

Hood



Casts a pleasant pool of light at floor level while eliminating glare - ideal for theatre or auditorium lighting.

Cutoff

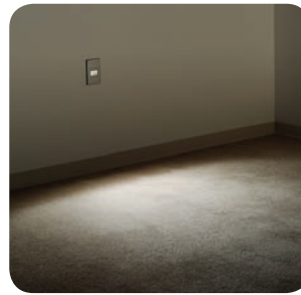

Balances low glare with a wide light pattern for steps and pathway lighting.

Louver



Integral louver provides superior shielding, making it an excellent choice for step lighting and other low level applications.



Juno Outdoor/Wet Location LED Mini Step Lights

Specially designed to resist the elements

Constructed of high-quality, die-cast aluminum, the LMS Series of Outdoor/Wet Location LED Mini IC-Rated Step Lights provides long lasting performance in many wet location applications. Designed to mount directly in standard 2"x4" (2-1/8" minimum depth) or 4"x4" (1-1/2" minimum depth) junction boxes.

IP65

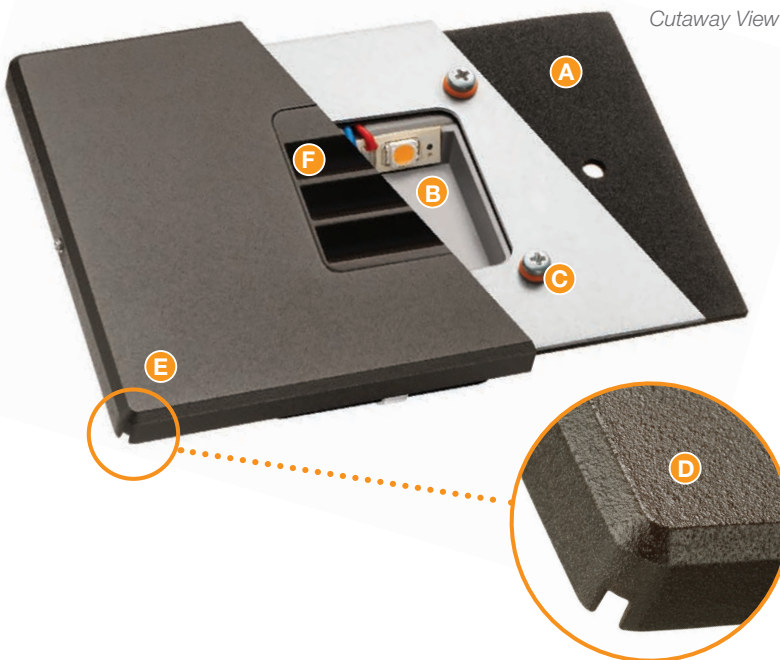

Cutaway View

- A. Gasket** protects the junction box from intrusion of water and contaminants.
- B. Light Engine Driver** features a diffused lens (not shown) that protects the LED against water infiltration. Accepts 120V input and is dimmable with reverse phase electronic low-voltage dimmers.
- C. O-rings** prevent water seepage around the screws.
- D. Drain Slot** guides water away from the fixture without compromising aesthetics.
- E. Decorative Faceplate with Corrosion-Resistant Finish** preserves the appearance for years of use. Field adjustable in horizontal or vertical orientation.
- F. Four optic choices** are available.

Finishes

Juno LED Mini Step Lights are available for both indoor and outdoor applications. High-quality indoor finishes include plated bronze and satin nickel; outdoor/wet location units are finished with corrosion-resistant textured bronze or silver for superior durability. All fixtures are also available in white or black.

Indoor (LMS) finishes

Shown in vertical orientation



Black, Textured

White, Textured

Satin Nickel, Plated

Bronze, Plated

Dimensions

LMS – Indoor (Shown in vertical orientation)

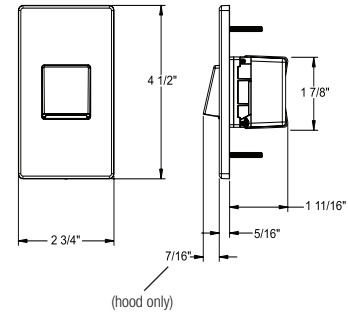

Outdoor/Wet Location (LMS) finishes

Shown in horizontal orientation



Dimensions

LMS – Wet Location (Shown in vertical orientation)

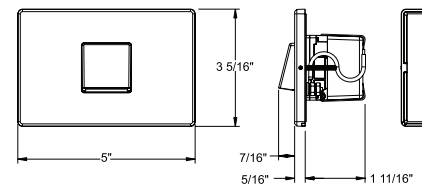

Ordering Information



Juno Mini LED Step Lights Examples: LMS 30K CTO 120 RPC BL, LMS 40K MKR 120 RPC WL SR

Series	CCT	Optic	Voltage/Driver	Environment	Trim Finish
LMS LED Mini Step Light	30K 3000K 40K 4000K	CTO Cutoff	120 RPC 120V Only; Reverse Phase Dimming	Blank Indoor WL Outdoor/ Wet Location	BL Black
		LVR Louver			WH White
	HD Hood	BZ Bronze			
	MKR Marker	SN Satin Nickel (Indoor Only) SR Silver (With WL option only)			

Step-up to Juno Performance LED Step Lights



The outdoor-rated Juno Performance LED Step Lights are the perfect combination of aesthetic fixture design and optimum illumination performance. These architectural-grade fixtures feature sleek, low-profile trims, attractively finished in corrosion-resistant, textured paint. Trims and matching hardware are available in black, white, silver, and bronze.

The unique all-in-one power module mounts directly to the cast aluminum trim and includes the LED light engine and 120-volt, non-dimming driver. The housing is independent of the trim and can be ordered separately, allowing it to be used for rough-in while the trim remains protected until the final stage of construction. The all-in-one power module can also be used to easily retrofit Juno PL115 CFL outdoor-rated step lights for LED operation.

Juno Performance LED Step Lights are rated for outdoor and indoor wall mount installations, including concrete pour, brick masonry, or dry wall. The IC-housings utilize gaskets to achieve wet location and IP65 ratings.



Performance

The clean, low profile Performance LED step light is aesthetically pleasing during the day and delivers exceptional performance at night.

Features:

- Low profile trim with baffle steps produces wide illumination patterns and minimizes glare
- LEDs are concealed from direct view with a matte textured diffuser
- Fixture produces up to 300 lumens with nominal 13W power consumption
- 3000K or 4000K color temperature available

Finishes



Black



White



Silver



Bronze

Ordering Information

Housing and power module trim ordered separately.

Back Housing
IC115LEDHSG



Ordering Example: 838LED 13W 40K 120 BL

Power Module Trim
838LED



Wattage
13W 13W

Color Temperature
30K 3000K
40K 4000K

Voltage
120 120V Only

Finish
BL Black Textured
WH White Textured
SR Silver Textured
BZ Bronze Textured

Trim Size

9-3/4" L x 3-5/8" H

Dimensions

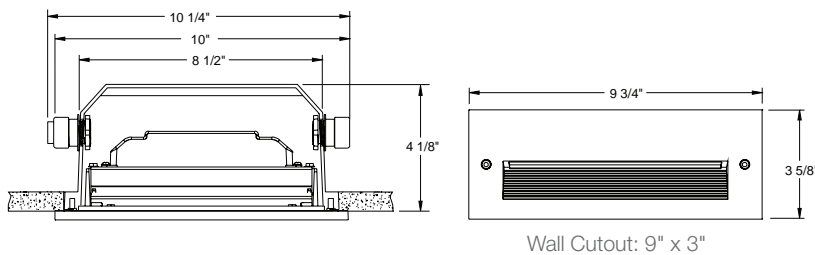

Juno Indoor and Outdoor Rated LED Step Lights

Juno LED step lights provide an energy efficient solution for low level lighting in indoor or outdoor applications. Consuming just 6 watts of power, these LED step lights use less energy than the comparable incandescent and fluorescent versions and are compatible with standard trims.



Indoor Rated LED Step/Night Light

The clean, low profile Performance LED step light is aesthetically pleasing during the day and delivers exceptional performance at night.

Features:

- Dedicated LED housing ships complete with LED light engine and 120-volt non-dimming driver
- Recessed housing is IC rated and can be completely covered with insulation
- Real Nail® 3 Bar Hangers for quick housing placement
- 3000K or 4000K color temperature available



Ordering Information

Housing and trim each ordered separately.

Ordering Example: IC113LED 30K 120

Housing	Color Temperature	Voltage
IC113LED	30K 3000K	120 120V Only
	40K 4000K	

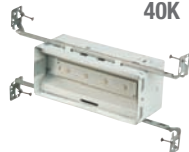

Trim	Description
104 WH	Diffuse Glass Lens White Trim
840 WH	Angled Louvers White Trim



Trim Size

9-9/16" L x 4-7/8" H

Dimensions

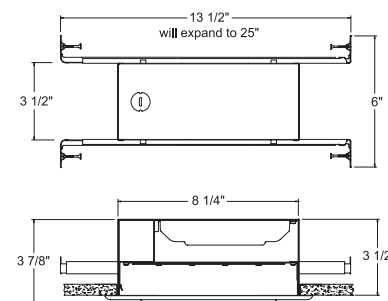

Cutout: 8-3/4" x 3-3/4"



Outdoor Rated LED Step Light

The Outdoor LED step light is rated for use in outdoor or indoor wall mount applications including concrete pour, brick masonry or drywall. Trims are cast aluminum and are offered in opal lens, grill, and louver designs.

Features:

- Die cast aluminum housing is IC rated and is gasketed for wet locations
- Back housing ships separately from power module for rough-in purposes
- Power module assembly with LED light engine and 120-volt non-dimming driver mounted directly to metal tray for ease of installation into housing
- 3000K or 4000K color temperature available



Ordering Information

Housing, power module and trim each ordered separately.

Back Housing

IC115LEDHSG



Ordering Example: IC115LEDPM 30K 120

Power Module	Color Temperature	Voltage
IC115LEDPM	30K 3000K	120 120V Only
	40K 4000K	



Ordering Example: 835 WH

Trim	Description
835 WH	Full Opal Lens - White
835 BL	Full Opal Lens - Black
836 WH	Opal Lens with Grill - White
836 BL	Opal Lens with Grill - Black
837 WH	Opal Lens with Angled Louvers - White
837 BL	Opal Lens with Angled Louvers - Black



Trim Size

9-3/4" L x 3-5/8" H

Dimensions

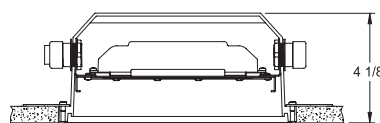
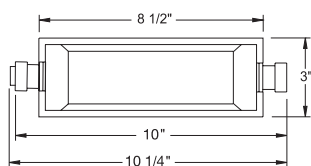

Wall Cutout: 9" x 3"

Juno CFL Step Lights

Juno CFL Step Lights integrate the economy and energy efficiency of compact fluorescent lamps into a high-quality step light fixture.



Indoor Rated CFL Step/Night Light

The Indoor CFL Step/Night Light is rated for use in indoor wall or ceiling mount drywall applications. Trim offering includes diffuse glass lens and louver designs.

Features:

- 7W or 9W 2-pin CFL lamp mounts horizontally in fixture
- Includes 120-volt non-dimming ballast
- Recessed housing is IC rated and can be completely covered with insulation
- Real Nail® 3 Bar Hangers for quick housing placement

Ordering Information

Housing and trim each ordered separately.

Housing	Voltage
ICPL813	120 120V Only



Trim Size

9-9/16" L x 4-7/8" H

Trim	Description
104 WH	Diffuse Glass Lens White Trim



840 WH	Angled Louvers White Trim
--------	------------------------------



Dimensions

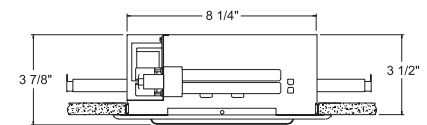
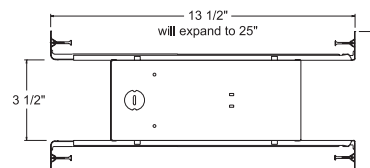

Wall cutout: 8-3/4" x 3-3/4"



Outdoor Rated CFL Step Light

The Outdoor CFL Step Light is rated for use in concrete pour applications or non-insulated areas. Trims are cast aluminum and offered in opal lens, grill and louver designs.

Features:

- 7W or 9W 2-pin CFL lamp mounts horizontally in fixture
- Includes 120-volt non-dimming ballast
- Die cast aluminum housing is gasketed for wet locations

Ordering Information

Housing and trim each ordered separately.

Housing	Voltage
PL115	120 120V Only



Trim Size

9-3/4" L x 3-5/8" H

Trim	Description
835 WH	Full Opal Lens - White
835 BL	Full Opal Lens - Black



836 WH	Opal Lens with Grill - White
836 BL	Opal Lens with Grill - Black



837 WH	Opal Lens with Angled Louvers - White
837 BL	Opal Lens with Angled Louvers - Black

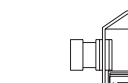

Dimensions

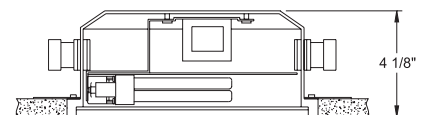
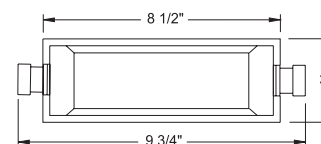

Wall cutout: 8-1/2" x 3"



Juno Incandescent Step Lights

Juno Incandescent Step Lights are a cost-effective option for indoor lighting.



Incandescent Step/Night Light

The Indoor Incandescent Step/Night Light is rated for use in indoor wall or ceiling mount drywall applications. Trim offering includes diffuse glass lens and louver designs.

Features:

- Provided with medium base porcelain socket
- Recessed housing is IC rated and can be completely covered with insulation
- Rated for 25W A19 in insulated, IC applications or 40W A19 in Non-IC
- Real Nail® 3 Bar Hangers for quick housing placement

Ordering Information

Housing and trim each ordered separately.

Housing
ICTC113



Trim	Description
104 WH	Diffuse Glass Lens White Trim



840 WH	Angled Louvers White Trim
---------------	------------------------------



Trim Size

9-9/16" L x 4-7/8" H

Trim Finish

WH - White

Dimensions

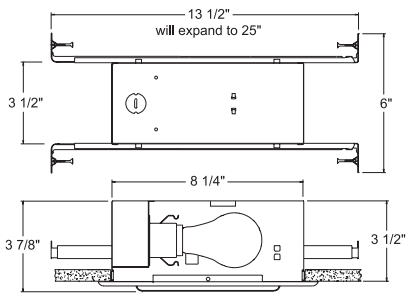

Wall cutout: 8-3/4" x 3-3/4"

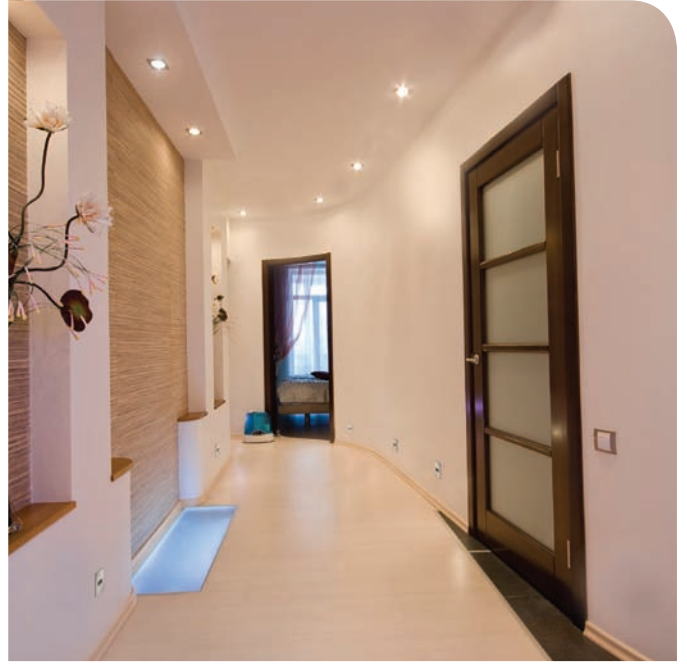

©2017 Acuity Brands Lighting, Inc. The marks appearing in this catalog are trademarks of Acuity Brands Lighting, Inc. Products shown in this brochure may be covered by U.S. and international patents and patents pending. Specifications subject to change without notice. Printed in the U.S.A.