

# Form 85™ Unilets™ Conduit Outlet Bodies, Covers and Gaskets

For use with Rigid Steel, Rigid Aluminum, IMC, and EMT Conduit.

NEC/CEC — Suitable for use in the following  
Hazardous Locations:  
Class I, Division 2 per NEC 501.10(B)(4)

## Applications

- Serve as pulling fittings.
- Make bends in conduit system.
- Provide openings for splicing.
- Connect and change direction of conduit runs.
- Allow connections for branch runs.
- Permit access to conductors for maintenance.

## Features

- Roomy interiors: more wiring space.
- Smooth, rounded integral bushings in hubs protect conductor insulation.
- Accurately tapped, tapered threads for tight, rigid joints and excellent ground continuity.
- Form 85 copperfree aluminum Unilets™ are lightweight, self-oxidizing, self-renewing and offer a high corrosion resistance.
- Lightweight aluminum facilitates shipping, handling and installing.
- Sizes with flat-back design ideal where fitting is mounted flat against surface.
- 1/2" to 3" blank covers are domed for extra wiring space.

## Standard Materials

- Bodies: copperfree (max. 4/10 of 1%) aluminum
  - 1/2" thru 2": pressure cast
  - 2-1/2" thru 4": sand cast
- Blank covers: malleable iron, steel or copperfree (max. 4/10 of 1%) aluminum
- Cover screws: stainless steel
- Gaskets: neoprene or composition fiber

## Standard Finishes

- Aluminum bodies: epoxy powder coat
- Stamped aluminum covers: natural finish
- Cast aluminum covers: epoxy powder coat

## Options

- PVC coating available on all threaded bodies and select covers.  
Add suffix **-PVC** to catalog number.

## NEC/CEC Certifications and Compliances

- UL Standards: 514A, 514B
- UL Listed: E2527
- CSA Standard: C22.2 No. 18.3
- CSA Certified: 065183
- NEMA Standard: FB-1

## Related Products

- For explosionproof conduit outlet bodies and boxes, see *Enclosures and Junction Boxes in Protection and Control of Electrical Apparatus and Circuits Catalog*.



Conduit Body with Stamped Aluminum Cover. 2" Type C shown.





Typical Form 85 Conduit Bodies with Setscrews.  
For use with Electrical Metallic Tubing (EMT).



# Form 85™ Unilets™ Conduit Outlet Bodies, Covers and Gaskets

Threaded Type for use with Rigid Metal Conduit and IMC; Setscrew Type for use with Electrical Metallic Tubing (EMT).

NEC/CEC — Suitable for use in the following  
 Hazardous Locations:  
 Class I, Division 2 per NEC 501.10(B)(4)

## Appleton™ Form 85™ Conduit Bodies: Threaded/SetScrew Type ①

Hub Size (Inches)	Max. Wire Fill	C		Max. Wire Fill	E		
		Threaded Type	Setscrew Type		Threaded Type	Setscrew Type	
							
1/2	②	C-50A	C-50TA	②	E-50A	E-50TA	
3/4	(3) # 6	C-75A	C-75TA	(3) # 6	E-75A	—	
1	(3) # 4	C-100A	C-100TA	(3) #6	E-100A	—	
1-1/4	(3) # 2	C-125A	C-125TA	—	—	—	
1-1/2	(3) # 1/0	C-150A	C-150TA	—	—	—	
2	(3) # 3/0	C-200A	—	—	—	—	
2-1/2	(3) 300	C-250A	—	—	—	—	
3	(3) 300	C-300A	—	—	—	—	
3-1/2	(3) 350	C-350A	—	—	—	—	
4	(3) 350	C-400A	—	—	—	—	

Hub Size (Inches)	Max. Wire Fill	LR		Max. Wire Fill	T		
		Threaded Type	Setscrew Type		Threaded Type	Setscrew Type	
							
1/2	②	LR-50A	LR-50TA	②	T-50A	T-50TA	
3/4	(3) # 6	LR-75A	LR-75TA	(3) # 6	T-75A	T-75TA	
1	(3) # 4	LR-100A	LR-100TA	(3) # 4	T-100A	T-100TA	
1-1/4	(3) # 2	LR-125A	LR-125TA	(3) # 2	T-125A	—	
1-1/2	(3) # 1	LR-150A	LR-150TA	(3) # 1	T-150A	—	
2	(3) # 2/0	LR-200A	LR-200TA	(3) # 2/0	T-200A	—	
2-1/2	(3) 300	LR-250A	—	(3) 300	T-250A	—	
3	(3) 350	LR-300A	—	(3) 300	T-300A	—	
3-1/2	(3) 350	LR-350A	—	(3) 350	T-350A	—	
4	(3) 350	LR-400A	—	(3) 350	T-400A	—	

① Refer to following page for Wiring Capacity Table.



② All 1/2" Max Wire Fill Calculations per the NEC - Annex C - Table C8.



# Form 85™ Unilets™ Conduit Outlet Bodies, Covers and Gaskets

Threaded Type for use with Rigid Metal Conduit and IMC; Setscrew Type for use with Electrical Metallic Tubing (EMT).

NEC/CEC — Suitable for use in the following  
Hazardous Locations:  
Class I, Division 2 per NEC 501.10(B)(4)

## Appleton™ Form 85™ Conduit Bodies: Threaded/SetScrew Type ①

Hub Size (Inches)	Max. Wire Fill	LB		Max. Wire Fill	LL	
		Threaded Type	Setscrew Type		Threaded Type	Setscrew Type
						
1/2	②	LB-50A	LB-50TA	②	LL-50A	LL-50TA
3/4	(3) # 6	LB-75A	LB-75TA	(3) # 6	LL-75A	LL-75TA
1	(3) # 4	LB-100A	LB-100TA	(3) # 4	LL-100A	LL-100TA
1-1/4	(3) # 2	LB-125A	LB-125TA	(3) # 2	LL-125A	LL-125TA
1-1/2	(3) # 1/0	LB-150A	LB-150TA	(3) # 1	LL-150A	LL-150TA
2	(3) # 4/0	LB-200A	LB-200TA	(3) # 2/0	LL-200A	LL-200TA
2-1/2	(3) 300	LB-250A	—	(3) 300	LL-250A	—
3	(3) 400	LB-300A	—	(3) 350	LL-300A	—
3-1/2	(3) 500	LB-350A	—	(3) 350	LL-350A	—
4	(3) 500	LB-400A	—	(3) 350	LL-400A	—

Hub Size (Inches)	Max. Wire Fill	TB		Max. Wire Fill	X	
		Threaded Type	Setscrew Type		Threaded Type	Setscrew Type
						
1/2	②	TB-50A	—	②	X-50A	—
3/4	(3) # 6	TB-75A	—	(3) # 6	X-75A	—
1	(3) # 6	TB-100A	—	(3) # 4	X-100A	—
1-1/4	(3) # 6	TB-125A	—	—	—	—
1-1/2	(3) # 4	TB-150A	—	—	—	—
2	(3) # 1/0	TB-200A	—	—	—	—
2-1/2	—	—	—	—	—	—
3	—	—	—	—	—	—
3-1/2	—	—	—	—	—	—
4	—	—	—	—	—	—

### Back Style for Form 85 Unilet Conduit Body Sizes (Inches)

Unilet Body	Flat Back	Round Back
C, LB, LL, LR, T	1/2 – 2	2-1/2 – 4
TB	1-1/4, 1-1/2	1/2, 3/4, 1, 2
E, X	1/2 – 1	—

① Refer to following page for Wiring Capacity Table.







② All 1/2" Max Wire Fill Calculations per the NEC - Annex C - Table C8.

# Form 85™ Unilets™ Conduit Outlet Bodies, Covers and Gaskets

Covers Furnished with Stainless Steel Fastening Screws.

NEC/CEC — Suitable for use in the following  
Hazardous Locations:  
Class I, Division 2 per NEC 501.10(B)(4)

## Covers and Gaskets

Body Size (Inches)	Blank Stamped Aluminum ①	Blank Cast Aluminum	Neoprene	Composition Fiber
	 Domed: 1/2" – 3"	 Flat: 1/2" – 2"		
	 Flat: 3-1/2" – 6"	 Domed: 2-1/2" – 4"	Tear out inner section to convert to "open type" gasket.	
1/2	K50-A	K50-CA	GK50-N	GK50-V
3/4	K75-A	K75-CA	GK75-N	GK75-V
1	K100-A	K100-CA	GK100-N	GK100-V
1-1/4	K125-150-A	K125-150-CA	GK125-150-N	GK125-150-V
1-1/2	K125-150-A	K125-150-CA	GK125-150-N	GK125-150-V
2	K200-A	K200-CA	GK200-N	GK200-V
2-1/2	K250-300-A	K250-300-CA	GK250-300-N	GK-250-300-V
3	K250-300-A	K250-300-CA	GK250-300-N	GK-250-300-V
3-1/2	K350-400-A	K350-400-CA	GK350-400-N	GK-350-400-V
4	K350-400-A	K350-400-CA	GK350-400-N	GK-350-400-V

## Wiring Capacity: Combine Body and Cover Capacities for Total Usable Capacity per NEC 314.16(A)

Hub Size (Inches)	Capacity — dm <sup>3</sup> (in <sup>3</sup> )										
	C	E	LB	LL LR	LRL	T	TA	TB	X	Stamped Cover	Cast Cover
1/2	0.07 (4.00)	0.07 (4.00)	0.07 (4.00)	0.07 (4.00)	—	0.07 (4.00)	—	0.10 (6.00)	0.07 (4.00)	0.01 (0.50)	0.00 (0.00)
3/4	0.11 (7.00)	0.11 (7.00)	0.11 (7.00)	0.11 (7.00)	—	0.11 (7.00)	—	0.11 (7.00)	0.11 (7.00)	0.01 (0.80)	0.00 (0.30)
1	0.19 (11.80)	0.19 (11.80)	0.19 (11.80)	0.19 (11.80)	—	0.19 (11.80)	—	0.21 (13.00)	0.19 (11.80)	1.00 (25.4)	0.01 (0.50)
1-1/4	0.57 (34.80)	—	0.57 (34.80)	0.57 (34.80)	—	0.57 (34.80)	—	0.57 (35.00)	—	0.04 (2.50)	0.01 (0.80)
1-1/2	0.57 (35.00)	—	0.57 (35.00)	0.57 (35.00)	—	0.57 (35.00)	—	0.57 (34.50)	—	0.04 (2.50)	0.01 (0.80)
2	1.15 (70.00)	—	1.15 (70.00)	1.15 (70.00)	—	1.15 (70.00)	—	1.16 (71.00)	—	0.11 (6.50)	0.02 (1.00)
2-1/2	2.34 (143.00)	—	2.28 (139.00)	3568.7 (140.50)	—	2.39 (146.00)	—	—	—	0.29 (18.00)	0.49 (30.00)
3	2.95 (180.00)	—	2.90 (177.00)	2.87 (175.00)	—	3.03 (185.00)	—	—	—	0.29 (18.00)	0.49 (30.00)
3-1/2	4.97 (303.00)	—	4.92 (300.00)	4.92 (300.00)	—	5.15 (314.00)	—	—	—	—	0.82 (50.00)
4	5.57 (340.00)	—	5.41 (330.00)	5.41 (330.00)	—	5.65 (345.00)	—	—	—	—	0.82 (50.00)

① Add suffix -PVC to catalog number.

# Form 85™ Unilets™ Conduit Outlet Bodies, Covers and Gaskets

For Rigid Conduit & IMC.

NEC/CEC — Suitable for use in the following  
Hazardous Locations:  
Class I, Division 2 per NEC 501.10(B)(4)

## Applications

- To provide access to conductors for pulling, splicing, maintenance and future changes/ upgrades.
- Allows connection of straight conduit runs, branch conduit runs and 90° bends.

## Features

- Tapered threaded hubs (NPT).
- Packaged complete with cover and gasket under one Catalog Number.
- Ready to use.

## Standard Materials

- Conduit Body: copperfree (max. 4/10 of 1%) aluminum
- Cover: **Type BS** copperfree (max. 4/10 of 1%) aluminum
- Gasket: **Type SGN** Neoprene

## Standard Finishes

- Conduit Body - epoxy powder coat enamel

## NEC/CEC Certifications and Compliances

- UL Standards: 514A
- UL Listed: E-18095
- CSA Standard: C22.2 No. 18
- CSA Certified: LR-9795
- NEMA Standard: FB-1, FB-2.10

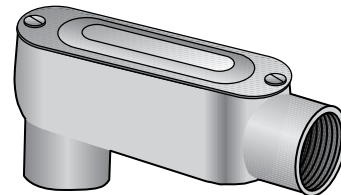

Type LB-ACGA

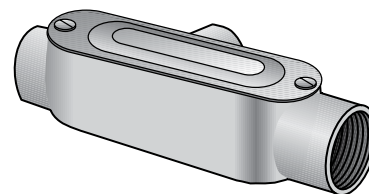

Type T-ACGA

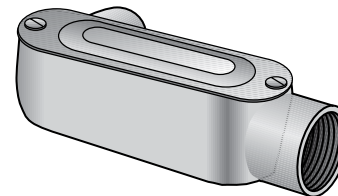

Type LL-ACGA

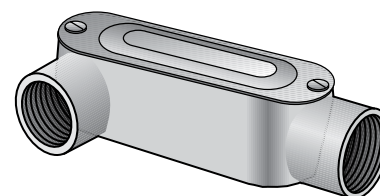

Type LR-ACGA

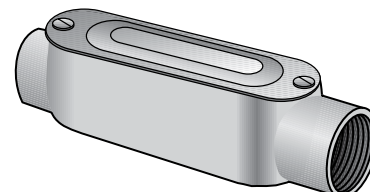

Type C-ACGA

# Form 85™ Unilets™ Conduit Outlet Bodies, Covers and Gaskets

For Rigid Conduit & IMC.



NEC/CEC — Suitable for use in the following

Hazardous Locations:

Class I, Division 2 per NEC 501.10(B)(4)

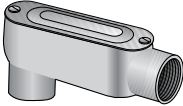
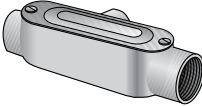
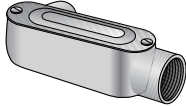
## Appleton™ Form 85™: Complete with Cover

Hub Size (Inches)	Max. Wire Fill	LB-ACGA	Max. Wire Fill	T-ACGA	Max. Wire Fill	LL-ACGA
						
1/2	①	<b>LB-50ACGA</b>	①	<b>T-50ACGA</b>	①	<b>LL-50ACGA</b>
3/4	(3) # 6	<b>LB-75ACGA</b>	(3) # 6	<b>T-75ACGA</b>	(3) # 6	<b>LL-75ACGA</b>
1	(3) # 4	<b>LB-100ACGA</b>	(3) # 4	<b>T-100ACGA</b>	(3) # 4	<b>LL-100ACGA</b>
1-1/4	(3) # 2	<b>LB-125ACGA</b>	(3) # 2	<b>T-125ACGA</b>	(3) # 2	<b>LL-125ACGA</b>
1-1/2	(3) # 1/0	<b>LB-150ACGA</b>	(3) # 1	<b>T-150ACGA</b>	(3) # 1	<b>LL-150ACGA</b>
2	(3) # 4/0	<b>LB-200ACGA</b>	(3) # 2/0	<b>T-200ACGA</b>	(3) # 2/0	<b>LL-200ACGA</b>

Hub Size (Inches)	Max. Wire Fill	LR-ACGA	Max. Wire Fill	C-ACGA
				
1/2	①	<b>LR-50ACGA</b>	①	<b>C-50ACGA</b>
3/4	(3) # 6	<b>LR-75ACGA</b>	(3) # 6	<b>C-75ACGA</b>
1	(3) # 4	<b>LR-100ACGA</b>	(3) # 4	<b>C-100ACGA</b>
1-1/4	(3) # 2	<b>LR-125ACGA</b>	(3) # 2	<b>C-125ACGA</b>
1-1/2	(3) # 1	<b>LR-150ACGA</b>	(3) # 1/0	<b>C-150ACGA</b>
2	(3) # 2/0	<b>LR-200ACGA</b>	(3) # 3/0	<b>C-200ACGA</b>

① All 1/2" Max Wire Fill Calculations per the NEC - Annex C - Table C8.

# Form 85™ Unilets™ Conduit Outlet Bodies, Covers and Gaskets

Threaded Type for use with Rigid Metal Conduit and IMC; Setscrew Type for use with Electrical Metallic Tubing (EMT).

NEC/CEC — Suitable for use in the following  
Hazardous Locations:  
Class I, Division 2 per NEC 501.10(B)(4)

## Dimensions in Millimeters (Inches)

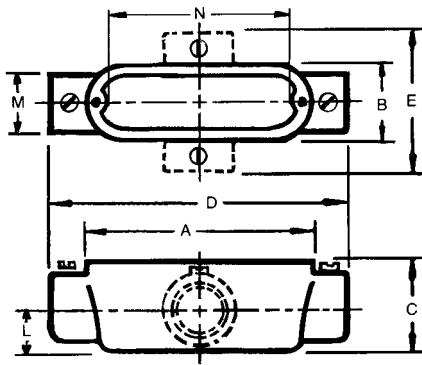

Types C, T, X

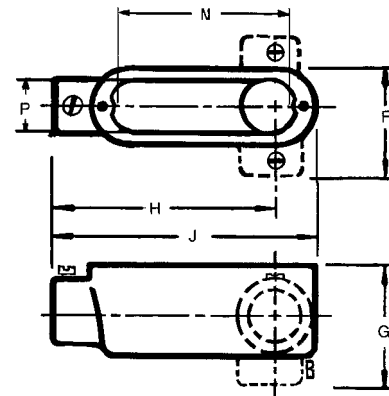

Types E, LB, LL, LR

Hub Size (Inches)	Dimensions In Millimeters (Inches)													
	A	B	C	D	E	F	G	H	J	L	M	N	P	
<b>Pressure Cast</b>														
1/2	100.1 (3.94)	33.3 (1.31)	35.1 (1.38)	120.7 (4.75)	65.0 (2.56)	50.8 (2.00)	52.3 (2.06)	88.9 (3.50)	109.5 (4.31)	16.0 (0.63)	28.7 (1.13)	79.8 (3.14)	26.7 (1.05)	
3/4	117.6 (4.63)	39.6 (1.56)	41.4 (1.63)	143.0 (5.63)	76.2 (3.00)	57.2 (2.25)	62.0 (2.44)	104.9 (4.13)	130.3 (5.13)	19.1 (0.75)	35.1 (1.38)	96.0 (3.78)	32.3 (1.27)	
1	136.7 (5.38)	46.0 (1.81)	47.8 (1.88)	169.9 (6.69)	88.9 (3.50)	66.8 (2.63)	71.4 (2.81)	124.0 (4.88)	152.4 (6.00)	23.9 (0.94)	42.9 (1.69)	114.3 (4.50)	38.6 (1.52)	
1-1/4	182.6 (7.19)	63.5 (2.50)	69.9 (2.75)	217.4 (8.56)	—	88.9 (3.50)	98.6 (3.88)	166.6 (6.56)	200.2 (7.88)	26.9 (1.06)	54.1 (2.13)	152.4 (6.00)	57.2 (2.25)	
1-1/2	182.6 (7.19)	63.5 (2.50)	69.9 (2.75)	217.4 (8.56)	—	88.9 (3.50)	96.8 (3.81)	163.6 (6.44)	200.2 (7.88)	30.2 (1.19)	60.5 (2.38)	152.4 (6.00)	57.2 (2.25)	
2	241.3 (9.50)	79.5 (3.13)	87.4 (3.44)	274.6 (10.81)	—	106.4 (4.19)	115.8 (4.56)	211.1 (8.31)	258.8 (10.19)	38.1 (1.50)	74.7 (2.94)	204.7 (8.06)	69.9 (2.75)	
<b>Sand Cast</b>														
2-1/2	311.2 (12.25)	109.5 (4.31)	98.6 (3.88)	384.3 (15.13)	—	146.1 (5.75)	133.4 (5.25)	301.8 (11.88)	347.7 (13.69)	46.0 (1.81)	85.9 (3.38)	270.0 (10.63)	93.7 (3.69)	
3	311.2 (12.25)	109.5 (4.31)	117.6 (4.63)	384.3 (15.13)	—	146.1 (5.75)	152.4 (6.00)	293.6 (11.56)	347.7 (13.69)	55.6 (2.19)	104.9 (4.13)	270.0 (10.63)	93.7 (3.69)	
3-1/2	378.0 (14.88)	139.7 (5.50)	131.8 (5.19)	460.5 (18.13)	—	181.1 (7.13)	173.0 (6.81)	355.6 (14.00)	419.1 (16.50)	63.5 (2.50)	120.7 (4.75)	333.5 (13.13)	124.0 (4.88)	
4	378.0 (14.88)	139.7 (5.50)	141.2 (5.56)	460.5 (18.13)	—	181.1 (7.13)	182.6 (7.19)	349.3 (13.75)	419.1 (16.50)	69.9 (2.75)	130.3 (5.13)	333.5 (13.13)	124.0 (4.88)	

# Form 85™ Unilets™ Conduit Outlet Bodies, Covers and Gaskets

For use with Rigid Steel, Rigid Aluminum, IMC, and EMT Conduit.

NEC/CEC — Suitable for use in the following  
Hazardous Locations:  
Class I, Division 2 per NEC 501.10(B)(4)

## Applications

- Serve as pulling fittings.
- Make bends in conduit system.
- Provide openings for splicing.
- Connect and change direction of conduit runs.
- Allow connections for branch runs.
- Permit access to conductors for maintenance.

## Features

- Roomy interiors: more wiring space.
- Smooth, rounded integral bushings in hubs protect conductor insulation.
- Accurately tapped, tapered threads for tight, rigid joints and excellent ground continuity.
- Form 85 copperfree aluminum Unilets™ are lightweight, self-oxidizing, self-renewing and offer a high corrosion resistance.
- Lightweight aluminum facilitates shipping, handling and installing.
- Sizes with flat-back design ideal where fitting is mounted flat against surface.
- 1/2" to 3" blank covers are domed for extra wiring space.

## Standard Materials

- Bodies: copperfree (max. 4/10 of 1%) aluminum
  - 1/2" thru 2": pressure cast
  - 2-1/2" thru 4": sand cast
- Blank covers: malleable iron, steel or copperfree (max. 4/10 of 1%) aluminum
- Cover screws: stainless steel
- Gaskets: neoprene or composition fiber

## Standard Finishes

- Aluminum bodies: epoxy powder coat
- Stamped aluminum covers: natural finish
- Cast aluminum covers: epoxy powder coat

## Options

- PVC coating available on all threaded bodies and select covers.  
Add suffix **-PVC** to catalog number.

## NEC/CEC Certifications and Compliances

- UL Standards: 514A, 514B
- UL Listed: E2527
- CSA Standard: C22.2 No. 18.3
- CSA Certified: 065183
- NEMA Standard: FB-1

## Related Products

- For explosionproof conduit outlet bodies and boxes, see *Enclosures and Junction Boxes in Protection and Control of Electrical Apparatus and Circuits Catalog*.



Conduit Body with Stamped Aluminum Cover. 2" Type C shown.



Typical Form 85 Conduit Bodies with Setscrews.  
For use with Electrical Metallic Tubing (EMT).







# Form 85™ Unilets™ Conduit Outlet Bodies, Covers and Gaskets

Threaded Type for use with Rigid Metal Conduit and IMC; Setscrew Type for use with Electrical Metallic Tubing (EMT).

NEC/CEC — Suitable for use in the following  
 Hazardous Locations:  
 Class I, Division 2 per NEC 501.10(B)(4)

## Appleton™ Form 85™ Conduit Bodies: Threaded/SetScrew Type ①

Hub Size (Inches)	Max. Wire Fill	C		Max. Wire Fill	E	
		Threaded Type	Setscrew Type		Threaded Type	Setscrew Type
						
1/2	②	C-50A	C-50TA	②	E-50A	E-50TA
3/4	(3) # 6	C-75A	C-75TA	(3) # 6	E-75A	—
1	(3) # 4	C-100A	C-100TA	(3) #6	E-100A	—
1-1/4	(3) # 2	C-125A	C-125TA	—	—	—
1-1/2	(3) # 1/0	C-150A	C-150TA	—	—	—
2	(3) # 3/0	C-200A	—	—	—	—
2-1/2	(3) 300	C-250A	—	—	—	—
3	(3) 300	C-300A	—	—	—	—
3-1/2	(3) 350	C-350A	—	—	—	—
4	(3) 350	C-400A	—	—	—	—

Hub Size (Inches)	Max. Wire Fill	LR		Max. Wire Fill	T	
		Threaded Type	Setscrew Type		Threaded Type	Setscrew Type
						
1/2	②	LR-50A	LR-50TA	②	T-50A	T-50TA
3/4	(3) # 6	LR-75A	LR-75TA	(3) # 6	T-75A	T-75TA
1	(3) # 4	LR-100A	LR-100TA	(3) # 4	T-100A	T-100TA
1-1/4	(3) # 2	LR-125A	LR-125TA	(3) # 2	T-125A	—
1-1/2	(3) # 1	LR-150A	LR-150TA	(3) # 1	T-150A	—
2	(3) # 2/0	LR-200A	LR-200TA	(3) # 2/0	T-200A	—
2-1/2	(3) 300	LR-250A	—	(3) 300	T-250A	—
3	(3) 350	LR-300A	—	(3) 300	T-300A	—
3-1/2	(3) 350	LR-350A	—	(3) 350	T-350A	—
4	(3) 350	LR-400A	—	(3) 350	T-400A	—

① Refer to following page for Wiring Capacity Table.



② All 1/2" Max Wire Fill Calculations per the NEC - Annex C - Table C8.



# Form 85™ Unilets™ Conduit Outlet Bodies, Covers and Gaskets

Threaded Type for use with Rigid Metal Conduit and IMC; Setscrew Type for use with Electrical Metallic Tubing (EMT).

NEC/CEC — Suitable for use in the following  
Hazardous Locations:  
Class I, Division 2 per NEC 501.10(B)(4)

## Appleton™ Form 85™ Conduit Bodies: Threaded/SetScrew Type ①

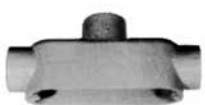
Hub Size (Inches)	Max. Wire Fill	LB		Max. Wire Fill	LL	
		Threaded Type	Setscrew Type		Threaded Type	Setscrew Type
						
1/2	②	LB-50A	LB-50TA	②	LL-50A	LL-50TA
3/4	(3) # 6	LB-75A	LB-75TA	(3) # 6	LL-75A	LL-75TA
1	(3) # 4	LB-100A	LB-100TA	(3) # 4	LL-100A	LL-100TA
1-1/4	(3) # 2	LB-125A	LB-125TA	(3) # 2	LL-125A	LL-125TA
1-1/2	(3) # 1/0	LB-150A	LB-150TA	(3) # 1	LL-150A	LL-150TA
2	(3) # 4/0	LB-200A	LB-200TA	(3) # 2/0	LL-200A	LL-200TA
2-1/2	(3) 300	LB-250A	—	(3) 300	LL-250A	—
3	(3) 400	LB-300A	—	(3) 350	LL-300A	—
3-1/2	(3) 500	LB-350A	—	(3) 350	LL-350A	—
4	(3) 500	LB-400A	—	(3) 350	LL-400A	—

Hub Size (Inches)	Max. Wire Fill	TB		Max. Wire Fill	X	
		Threaded Type	Setscrew Type		Threaded Type	Setscrew Type
						
1/2	②	TB-50A	—	②	X-50A	—
3/4	(3) # 6	TB-75A	—	(3) # 6	X-75A	—
1	(3) # 6	TB-100A	—	(3) # 4	X-100A	—
1-1/4	(3) # 6	TB-125A	—	—	—	—
1-1/2	(3) # 4	TB-150A	—	—	—	—
2	(3) # 1/0	TB-200A	—	—	—	—
2-1/2	—	—	—	—	—	—
3	—	—	—	—	—	—
3-1/2	—	—	—	—	—	—
4	—	—	—	—	—	—

### Back Style for Form 85 Unilet Conduit Body Sizes (Inches)

Unilet Body	Flat Back	Round Back
C, LB, LL, LR, T	1/2 – 2	2-1/2 – 4
TB	1-1/4, 1-1/2	1/2, 3/4, 1, 2
E, X	1/2 – 1	—

① Refer to following page for Wiring Capacity Table.







② All 1/2" Max Wire Fill Calculations per the NEC - Annex C - Table C8.

# Form 85™ Unilets™ Conduit Outlet Bodies, Covers and Gaskets

Covers Furnished with Stainless Steel Fastening Screws.

NEC/CEC — Suitable for use in the following  
Hazardous Locations:  
Class I, Division 2 per NEC 501.10(B)(4)

## Covers and Gaskets

Body Size (Inches)	Blank Stamped Aluminum ①	Blank Cast Aluminum	Neoprene	Composition Fiber
	 Domed: 1/2" – 3"	 Flat: 1/2" – 2"		
	 Flat: 3-1/2" – 6"	 Domed: 2-1/2" – 4"	Tear out inner section to convert to "open type" gasket.	
1/2	K50-A	K50-CA	GK50-N	GK50-V
3/4	K75-A	K75-CA	GK75-N	GK75-V
1	K100-A	K100-CA	GK100-N	GK100-V
1-1/4	K125-150-A	K125-150-CA	GK125-150-N	GK125-150-V
1-1/2	K125-150-A	K125-150-CA	GK125-150-N	GK125-150-V
2	K200-A	K200-CA	GK200-N	GK200-V
2-1/2	K250-300-A	K250-300-CA	GK250-300-N	GK-250-300-V
3	K250-300-A	K250-300-CA	GK250-300-N	GK-250-300-V
3-1/2	K350-400-A	K350-400-CA	GK350-400-N	GK-350-400-V
4	K350-400-A	K350-400-CA	GK350-400-N	GK-350-400-V

## Wiring Capacity: Combine Body and Cover Capacities for Total Usable Capacity per NEC 314.16(A)

Hub Size (Inches)	Capacity — dm <sup>3</sup> (in <sup>3</sup> )										
	C	E	LB	LL LR	LRL	T	TA	TB	X	Stamped Cover	Cast Cover
1/2	0.07 (4.00)	0.07 (4.00)	0.07 (4.00)	0.07 (4.00)	—	0.07 (4.00)	—	0.10 (6.00)	0.07 (4.00)	0.01 (0.50)	0.00 (0.00)
3/4	0.11 (7.00)	0.11 (7.00)	0.11 (7.00)	0.11 (7.00)	—	0.11 (7.00)	—	0.11 (7.00)	0.11 (7.00)	0.01 (0.80)	0.00 (0.30)
1	0.19 (11.80)	0.19 (11.80)	0.19 (11.80)	0.19 (11.80)	—	0.19 (11.80)	—	0.21 (13.00)	0.19 (11.80)	1.00 (25.4)	0.01 (0.50)
1-1/4	0.57 (34.80)	—	0.57 (34.80)	0.57 (34.80)	—	0.57 (34.80)	—	0.57 (35.00)	—	0.04 (2.50)	0.01 (0.80)
1-1/2	0.57 (35.00)	—	0.57 (35.00)	0.57 (35.00)	—	0.57 (35.00)	—	0.57 (34.50)	—	0.04 (2.50)	0.01 (0.80)
2	1.15 (70.00)	—	1.15 (70.00)	1.15 (70.00)	—	1.15 (70.00)	—	1.16 (71.00)	—	0.11 (6.50)	0.02 (1.00)
2-1/2	2.34 (143.00)	—	2.28 (139.00)	3568.7 (140.50)	—	2.39 (146.00)	—	—	—	0.29 (18.00)	0.49 (30.00)
3	2.95 (180.00)	—	2.90 (177.00)	2.87 (175.00)	—	3.03 (185.00)	—	—	—	0.29 (18.00)	0.49 (30.00)
3-1/2	4.97 (303.00)	—	4.92 (300.00)	4.92 (300.00)	—	5.15 (314.00)	—	—	—	—	0.82 (50.00)
4	5.57 (340.00)	—	5.41 (330.00)	5.41 (330.00)	—	5.65 (345.00)	—	—	—	—	0.82 (50.00)

① Add suffix -PVC to catalog number.

# Form 85™ Unilets™ Conduit Outlet Bodies, Covers and Gaskets

For Rigid Conduit & IMC.

NEC/CEC — Suitable for use in the following  
Hazardous Locations:  
Class I, Division 2 per NEC 501.10(B)(4)

## Applications

- To provide access to conductors for pulling, splicing, maintenance and future changes/ upgrades.
- Allows connection of straight conduit runs, branch conduit runs and 90° bends.

## Features

- Tapered threaded hubs (NPT).
- Packaged complete with cover and gasket under one Catalog Number.
- Ready to use.

## Standard Materials

- Conduit Body: copperfree (max. 4/10 of 1%) aluminum
- Cover: **Type BS** copperfree (max. 4/10 of 1%) aluminum
- Gasket: **Type SGN** Neoprene

## Standard Finishes

- Conduit Body - epoxy powder coat enamel

## NEC/CEC Certifications and Compliances

- UL Standards: 514A
- UL Listed: E-18095
- CSA Standard: C22.2 No. 18
- CSA Certified: LR-9795
- NEMA Standard: FB-1, FB-2.10

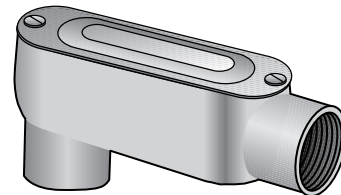

Type LB-ACGA

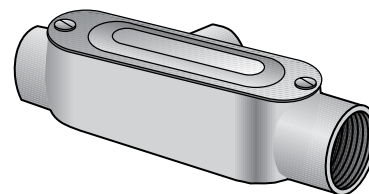

Type T-ACGA

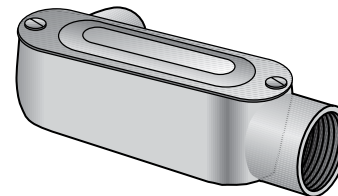

Type LL-ACGA

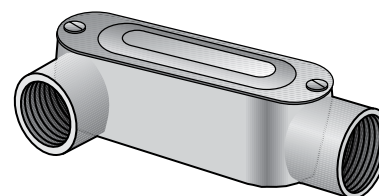

Type LR-ACGA

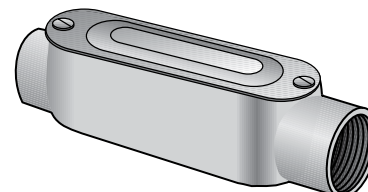

Type C-ACGA

APPLETON

COMMERCIAL AND INDUSTRIAL FITTINGS: CONDUIT BODIES

# Form 85™ Unilets™ Conduit Outlet Bodies, Covers and Gaskets

For Rigid Conduit & IMC.



NEC/CEC — Suitable for use in the following

Hazardous Locations:

Class I, Division 2 per NEC 501.10(B)(4)

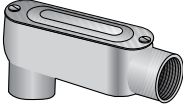
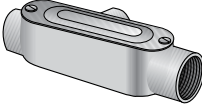
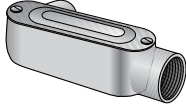
## Appleton™ Form 85™: Complete with Cover

Hub Size (Inches)	Max. Wire Fill	LB-ACGA	Max. Wire Fill	T-ACGA	Max. Wire Fill	LL-ACGA
						
1/2	①	<b>LB-50ACGA</b>	①	<b>T-50ACGA</b>	①	<b>LL-50ACGA</b>
3/4	(3) # 6	<b>LB-75ACGA</b>	(3) # 6	<b>T-75ACGA</b>	(3) # 6	<b>LL-75ACGA</b>
1	(3) # 4	<b>LB-100ACGA</b>	(3) # 4	<b>T-100ACGA</b>	(3) # 4	<b>LL-100ACGA</b>
1-1/4	(3) # 2	<b>LB-125ACGA</b>	(3) # 2	<b>T-125ACGA</b>	(3) # 2	<b>LL-125ACGA</b>
1-1/2	(3) # 1/0	<b>LB-150ACGA</b>	(3) # 1	<b>T-150ACGA</b>	(3) # 1	<b>LL-150ACGA</b>
2	(3) # 4/0	<b>LB-200ACGA</b>	(3) # 2/0	<b>T-200ACGA</b>	(3) # 2/0	<b>LL-200ACGA</b>

Hub Size (Inches)	Max. Wire Fill	LR-ACGA	Max. Wire Fill	C-ACGA
				
1/2	①	<b>LR-50ACGA</b>	①	<b>C-50ACGA</b>
3/4	(3) # 6	<b>LR-75ACGA</b>	(3) # 6	<b>C-75ACGA</b>
1	(3) # 4	<b>LR-100ACGA</b>	(3) # 4	<b>C-100ACGA</b>
1-1/4	(3) # 2	<b>LR-125ACGA</b>	(3) # 2	<b>C-125ACGA</b>
1-1/2	(3) # 1	<b>LR-150ACGA</b>	(3) # 1/0	<b>C-150ACGA</b>
2	(3) # 2/0	<b>LR-200ACGA</b>	(3) # 3/0	<b>C-200ACGA</b>

① All 1/2" Max Wire Fill Calculations per the NEC - Annex C - Table C8.

# Form 85™ Unilets™ Conduit Outlet Bodies, Covers and Gaskets

Threaded Type for use with Rigid Metal Conduit and IMC; Setscrew Type for use with Electrical Metallic Tubing (EMT).

NEC/CEC — Suitable for use in the following  
Hazardous Locations:  
Class I, Division 2 per NEC 501.10(B)(4)

## Dimensions in Millimeters (Inches)

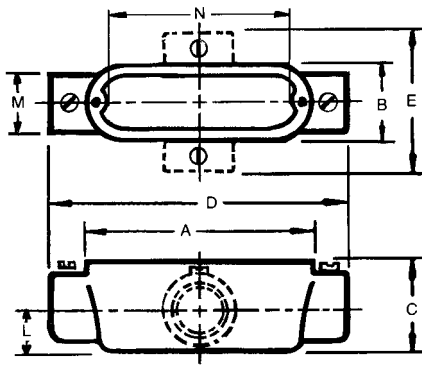

Types C, T, X

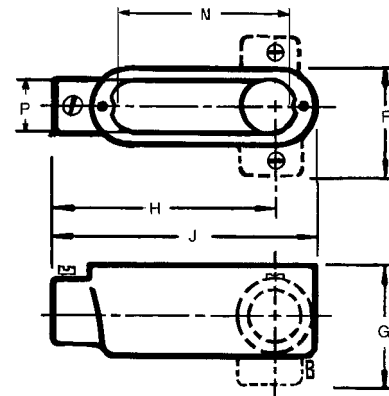

Types E, LB, LL, LR

Hub Size (Inches)	Dimensions In Millimeters (Inches)													
	A	B	C	D	E	F	G	H	J	L	M	N	P	
<b>Pressure Cast</b>														
1/2	100.1 (3.94)	33.3 (1.31)	35.1 (1.38)	120.7 (4.75)	65.0 (2.56)	50.8 (2.00)	52.3 (2.06)	88.9 (3.50)	109.5 (4.31)	16.0 (0.63)	28.7 (1.13)	79.8 (3.14)	26.7 (1.05)	
3/4	117.6 (4.63)	39.6 (1.56)	41.4 (1.63)	143.0 (5.63)	76.2 (3.00)	57.2 (2.25)	62.0 (2.44)	104.9 (4.13)	130.3 (5.13)	19.1 (0.75)	35.1 (1.38)	96.0 (3.78)	32.3 (1.27)	
1	136.7 (5.38)	46.0 (1.81)	47.8 (1.88)	169.9 (6.69)	88.9 (3.50)	66.8 (2.63)	71.4 (2.81)	124.0 (4.88)	152.4 (6.00)	23.9 (0.94)	42.9 (1.69)	114.3 (4.50)	38.6 (1.52)	
1-1/4	182.6 (7.19)	63.5 (2.50)	69.9 (2.75)	217.4 (8.56)	—	88.9 (3.50)	98.6 (3.88)	166.6 (6.56)	200.2 (7.88)	26.9 (1.06)	54.1 (2.13)	152.4 (6.00)	57.2 (2.25)	
1-1/2	182.6 (7.19)	63.5 (2.50)	69.9 (2.75)	217.4 (8.56)	—	88.9 (3.50)	96.8 (3.81)	163.6 (6.44)	200.2 (7.88)	30.2 (1.19)	60.5 (2.38)	152.4 (6.00)	57.2 (2.25)	
2	241.3 (9.50)	79.5 (3.13)	87.4 (3.44)	274.6 (10.81)	—	106.4 (4.19)	115.8 (4.56)	211.1 (8.31)	258.8 (10.19)	38.1 (1.50)	74.7 (2.94)	204.7 (8.06)	69.9 (2.75)	
<b>Sand Cast</b>														
2-1/2	311.2 (12.25)	109.5 (4.31)	98.6 (3.88)	384.3 (15.13)	—	146.1 (5.75)	133.4 (5.25)	301.8 (11.88)	347.7 (13.69)	46.0 (1.81)	85.9 (3.38)	270.0 (10.63)	93.7 (3.69)	
3	311.2 (12.25)	109.5 (4.31)	117.6 (4.63)	384.3 (15.13)	—	146.1 (5.75)	152.4 (6.00)	293.6 (11.56)	347.7 (13.69)	55.6 (2.19)	104.9 (4.13)	270.0 (10.63)	93.7 (3.69)	
3-1/2	378.0 (14.88)	139.7 (5.50)	131.8 (5.19)	460.5 (18.13)	—	181.1 (7.13)	173.0 (6.81)	355.6 (14.00)	419.1 (16.50)	63.5 (2.50)	120.7 (4.75)	333.5 (13.13)	124.0 (4.88)	
4	378.0 (14.88)	139.7 (5.50)	141.2 (5.56)	460.5 (18.13)	—	181.1 (7.13)	182.6 (7.19)	349.3 (13.75)	419.1 (16.50)	69.9 (2.75)	130.3 (5.13)	333.5 (13.13)	124.0 (4.88)	