



KT-LED15T8-48GC-840-D

T8 LED LAMP

DESCRIPTION

15W T8 LED | 4000K | >83 CRI | High Efficiency



| |
|---|
| LAMP TYPE: Linear |
| BULB TYPE: T8 LED |
| BASE TYPE: G13 (Medium Bi-Pin) |
| WATTAGE: 15W |
| COLOR TEMPERATURE: 4000K |
| COLOR RENDERING INDEX (CRI): >83 |
| WARRANTY: 5 Years |



PRODUCT FEATURES

- Replacement for Conventional Fluorescent Lamp
- 50,000+ Hour Lifetime
- Approximately 40% More Energy Efficient than Standard F32T8 Lamps
- Environmentally Friendly: No Mercury Used
- Instant Startup
- Frosted Lens Eliminates Pixelation
- UL Classified; Listed on DLC Qualified Product List
- Operating Temperature: -20°C/-4°F to 45°C/113°F
- Integral Driver (Isolated), Eliminates the Need for External Driver or Ballast
- 110+ Lumens per Watt
- Improved Lamp Durability with Shatterproof Coated Glass
- ETL Sanitation Listed NSF/ANSI Standard 2 - Food Equipment

OPERATING SPECIFICATIONS

ELECTRICAL CHARACTERISTICS

| Input Voltage | Power Consumption | Power Factor | Input Current |
|---------------|-------------------|--------------|------------------------------|
| 120-277Vac | 15W | >0.9 | 0.16A @ 120V 0.07A @ 277V |

PHOTOMETRIC CHARACTERISTICS

| | |
|-----------------------------|----------|
| Color Temperature (CCT) | 4000K |
| Luminous Flux | 1850 lm |
| Color Rendering Index (CRI) | >83 |
| Efficacy | 121 lm/W |
| Beam Angle | 240° |
| Visible Light Area | 325° |

RATED LIFE

| | |
|-------------|--------|
| L70 (Hours) | 50,000 |
|-------------|--------|

SPECTRAL DISTRIBUTION

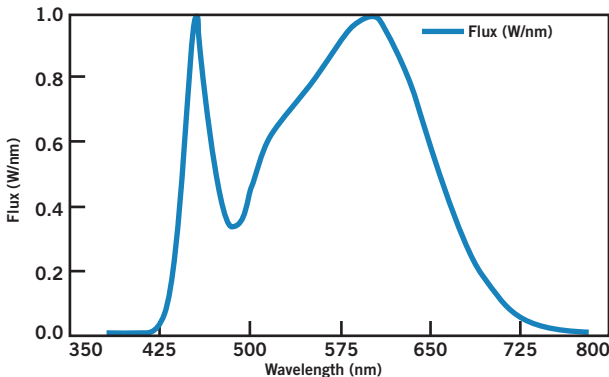

POLAR CANDELA DISTRIBUTION

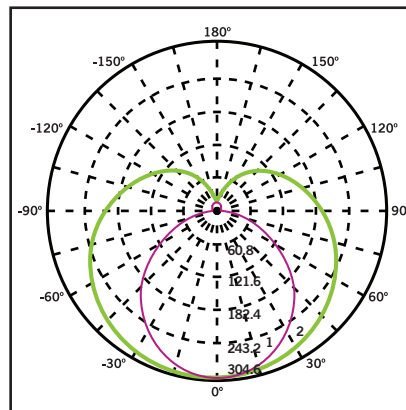

Maximum Candela = 1248.55
Located at Horizontal Angle = 0,
Vertical Angle 0

1. Violet Vertical Plane through Horizontal Angles (90-270)
2. Green Vertical Plane through Horizontal Angles (0-180)



KT-LED15T8-48GC-840-D

T8 LED LAMP

WIRING DIAGRAMS

1. Cut all existing connections to ballast as shown below and remove ballast.

Typical Ballast Configurations:

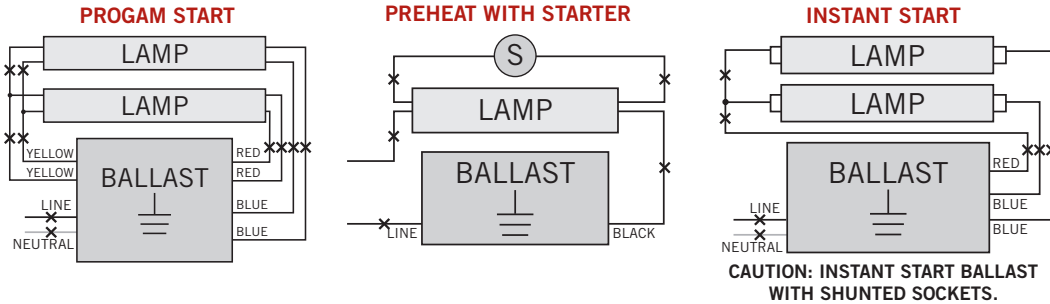

Typical Non-Shunted Lampholder

Connect wires directly to these terminals

CAUTION: Use only non-shunted lampholders.
 Do not install product in a fixture with shunted lampholders (found in all fixtures using instant start ballasts). If the current lampholders are shunted, remove them and replace them with non-shunted lampholders. Make new connections directly to terminals as indicated above.

Keystone can provide any style replacement lampholders.
 Call us at 800-464-2680.

2. Re-wire fixture as shown below.

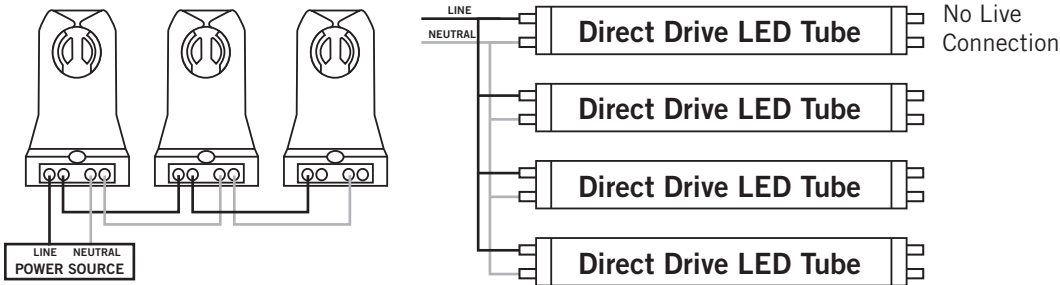

PHYSICAL CHARACTERISTICS

LAMP DIMENSIONS

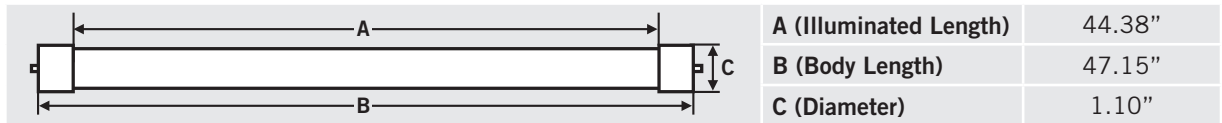

NOMINAL LENGTH: 48" BASE TYPE: G13 (Medium Bi-Pin)

ORDERING INFORMATION

| ORDER CODE | PACKAGING STYLE | PACK QTY. | ITEM STATUS |
|------------------------------|---------------------------------------|-----------|-------------|
| KT-LED15T8-48GC-840-D /G3-CP | Carton Pack (Egg Crate Packaging) | 25 | Quick Ship |
| KT-LED15T8-48GC-840-D /G3-DP | Distributor Pack (Individual Cartons) | 12 | Quick Ship |

CATALOG NUMBER BREAKDOWN

KT-LED15T8-48GC-840-D /G3-CP

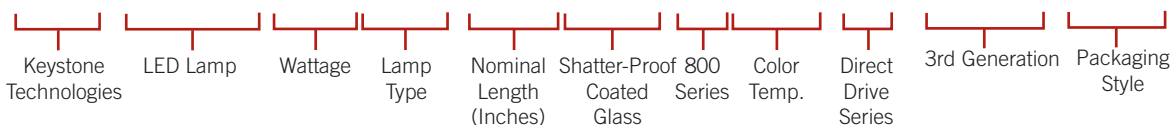



KT-LED15T8-48GC-840-D

T8 LED LAMP

DESCRIPTION

15W T8 LED | 4000K | >83 CRI | High Efficiency



| |
|---|
| LAMP TYPE: Linear |
| BULB TYPE: T8 LED |
| BASE TYPE: G13 (Medium Bi-Pin) |
| WATTAGE: 15W |
| COLOR TEMPERATURE: 4000K |
| COLOR RENDERING INDEX (CRI): >83 |
| WARRANTY: 5 Years |



PRODUCT FEATURES

- Replacement for Conventional Fluorescent Lamp
- 50,000+ Hour Lifetime
- Approximately 40% More Energy Efficient than Standard F32T8 Lamps
- Environmentally Friendly: No Mercury Used
- Instant Startup
- Frosted Lens Eliminates Pixelation
- UL Classified; Listed on DLC Qualified Product List
- Operating Temperature: -20°C/-4°F to 45°C/113°F
- Integral Driver (Isolated), Eliminates the Need for External Driver or Ballast
- 110+ Lumens per Watt
- Improved Lamp Durability with Shatterproof Coated Glass
- ETL Sanitation Listed NSF/ANSI Standard 2 - Food Equipment

OPERATING SPECIFICATIONS

ELECTRICAL CHARACTERISTICS

| Input Voltage | Power Consumption | Power Factor | Input Current |
|---------------|-------------------|--------------|------------------------------|
| 120-277Vac | 15W | >0.9 | 0.16A @ 120V 0.07A @ 277V |

PHOTOMETRIC CHARACTERISTICS

| | |
|-----------------------------|----------|
| Color Temperature (CCT) | 4000K |
| Luminous Flux | 1850 lm |
| Color Rendering Index (CRI) | >83 |
| Efficacy | 121 lm/W |
| Beam Angle | 240° |
| Visible Light Area | 325° |

RATED LIFE

| | |
|-------------|--------|
| L70 (Hours) | 50,000 |
|-------------|--------|

SPECTRAL DISTRIBUTION

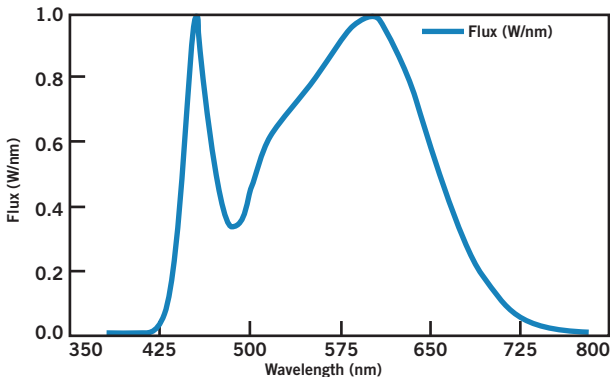

POLAR CANDELA DISTRIBUTION

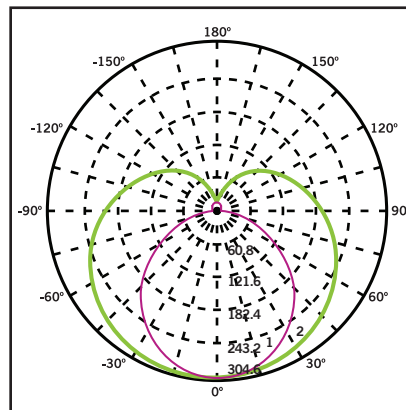

Maximum Candela = 1248.55
Located at Horizontal Angle = 0,
Vertical Angle 0

1. Violet Vertical Plane through Horizontal Angles (90-270)
2. Green Vertical Plane through Horizontal Angles (0-180)



KT-LED15T8-48GC-840-D

T8 LED LAMP

WIRING DIAGRAMS

1. Cut all existing connections to ballast as shown below and remove ballast.

Typical Ballast Configurations:

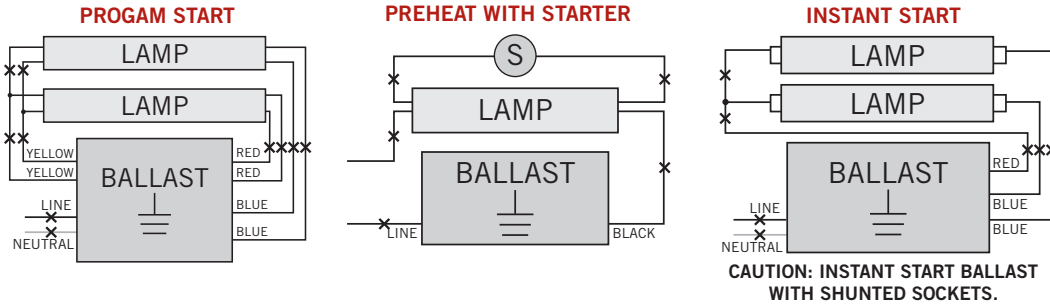

Typical Non-Shunted Lampholder

Connect wires directly to these terminals

CAUTION: Use only non-shunted lampholders.
Do not install product in a fixture with shunted lampholders (found in all fixtures using instant start ballasts). If the current lampholders are shunted, remove them and replace them with non-shunted lampholders. Make new connections directly to terminals as indicated above.

Keystone can provide any style replacement lampholders.
Call us at 800-464-2680.

2. Re-wire fixture as shown below.

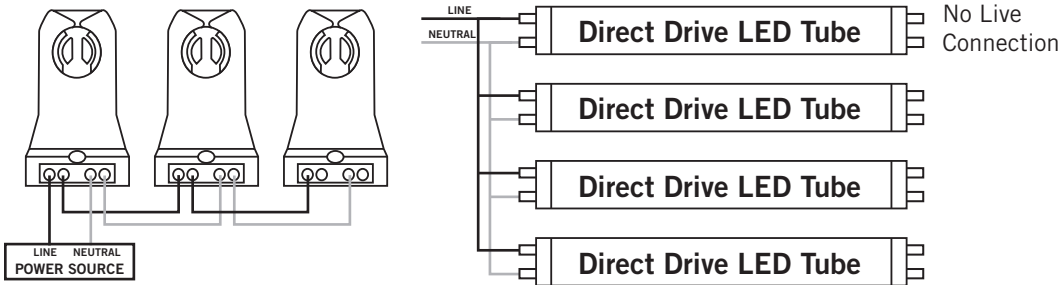

PHYSICAL CHARACTERISTICS

LAMP DIMENSIONS

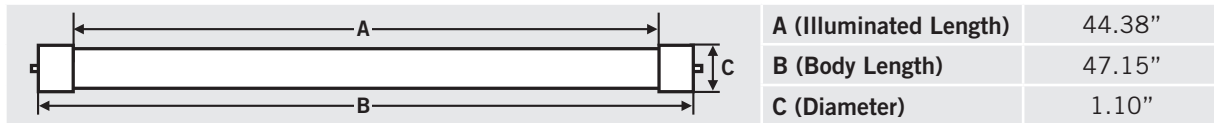

NOMINAL LENGTH: 48" BASE TYPE: G13 (Medium Bi-Pin)

ORDERING INFORMATION

| ORDER CODE | PACKAGING STYLE | PACK QTY. | ITEM STATUS |
|------------------------------|---------------------------------------|-----------|-------------|
| KT-LED15T8-48GC-840-D /G3-CP | Carton Pack (Egg Crate Packaging) | 25 | Quick Ship |
| KT-LED15T8-48GC-840-D /G3-DP | Distributor Pack (Individual Cartons) | 12 | Quick Ship |

CATALOG NUMBER BREAKDOWN

KT-LED15T8-48GC-840-D /G3-CP

