



# KT-LED7T8-24GC-840-D

## T8 LED LAMP

### DESCRIPTION

7W T8 LED | 4000K | >83 CRI | High Efficiency



<b>LAMP TYPE:</b> Linear
<b>BULB TYPE:</b> T8 LED
<b>BASE TYPE:</b> G13 (Medium Bi-Pin)
<b>WATTAGE:</b> 7W
<b>COLOR TEMPERATURE:</b> 4000K
<b>COLOR RENDERING INDEX (CRI):</b> >83
<b>WARRANTY:</b> 5 Years



### PRODUCT FEATURES

- Replacement for Conventional Fluorescent Lamp
- 50,000+ Hour Lifetime
- Environmentally Friendly: No Mercury Used
- Instant Startup
- Frosted Lens Eliminates Pixelation
- UL Classified; Listed on DLC Qualified Product List
- Operating Temperature: -20°C/-4°F to 45°C/113°F

- Integral Driver (Isolated), Eliminates the Need for External Driver or Ballast
- 110+ Lumens per Watt
- Improved Lamp Durability with Shatterproof Coated Glass, designed to pass drop tests of 6' on hard surface
- ETL Sanitation Listed NSF/ANSI Standard 2 - Food Equipment, Splash Zone (Not for Direct Food Zone without additional fixture considerations)

### OPERATING SPECIFICATIONS

#### ELECTRICAL CHARACTERISTICS

Input Voltage	Power Consumption	Power Factor	Input Current
120-277Vac	7W	>0.9	0.06A @ 120V 0.03A @ 277V

#### PHOTOMETRIC CHARACTERISTICS

Color Temperature (CCT)	4000K
Luminous Flux	900 lm
Color Rendering Index (CRI)	>83
Efficacy	129 lm/W
Beam Angle	240°
Visible Light Area	325°

#### RATED LIFE

L70 (Hours)	50,000
-------------	--------

#### SPECTRAL DISTRIBUTION

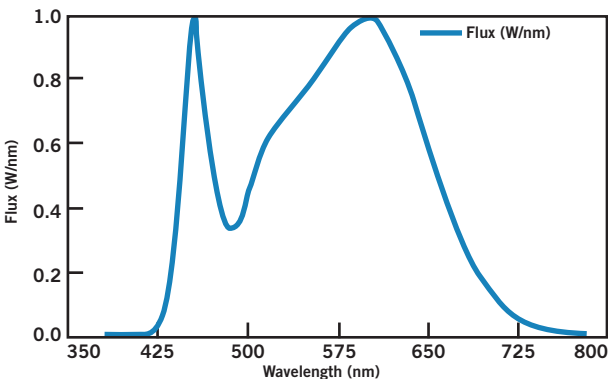

#### POLAR CANDELA DISTRIBUTION

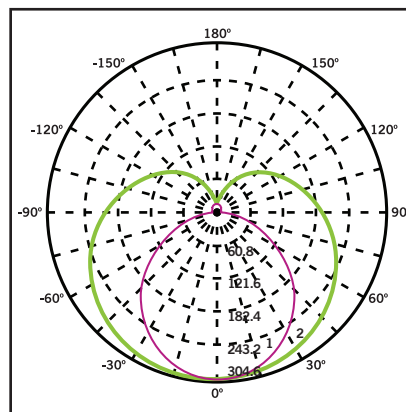

Maximum Candela = 1248.55  
Located at Horizontal Angle = 0,  
Vertical Angle 0

1. Violet Vertical Plane through Horizontal Angles (90-270)
2. Green Vertical Plane through Horizontal Angles (0-180)



# KT-LED7T8-24GC-840-D

## T8 LED LAMP

### WIRING DIAGRAMS

1. Cut all existing connections to ballast as shown below and remove ballast.

#### Typical Ballast Configurations:

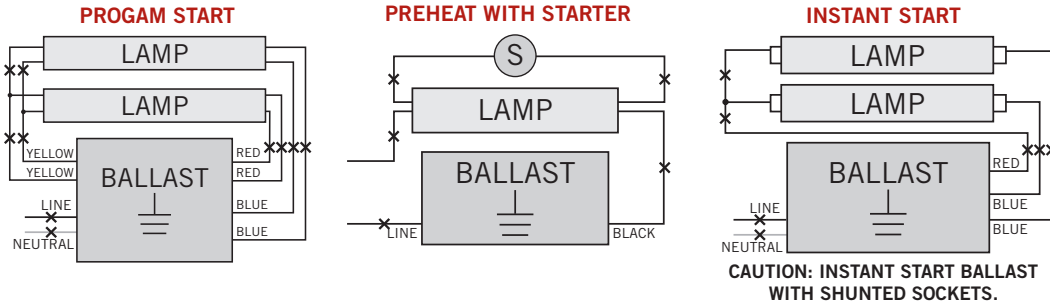

**Typical Non-Shunted Lampholder**

Connect wires directly to these terminals

**CAUTION: Use only non-shunted lampholders.**

Do not install product in a fixture with shunted lampholders (found in all fixtures using instant start ballasts). If the current lampholders are shunted, remove them and replace them with non-shunted lampholders. Make new connections directly to terminals as indicated above.

Keystone can provide any style replacement lampholders.  
Call us at 800-464-2680.

2. Re-wire fixture as shown below.

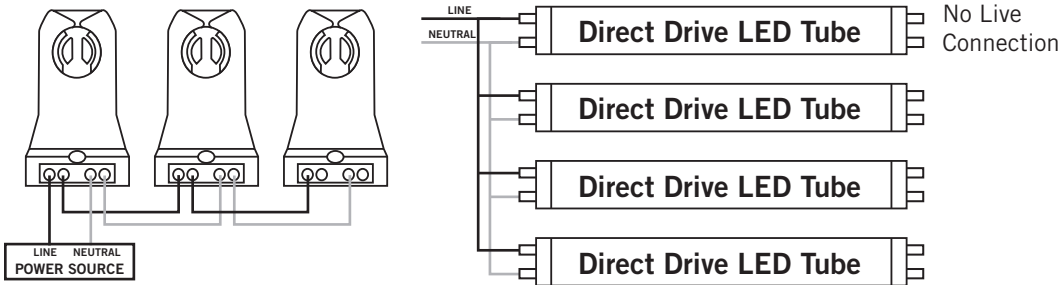

### PHYSICAL CHARACTERISTICS

#### LAMP DIMENSIONS

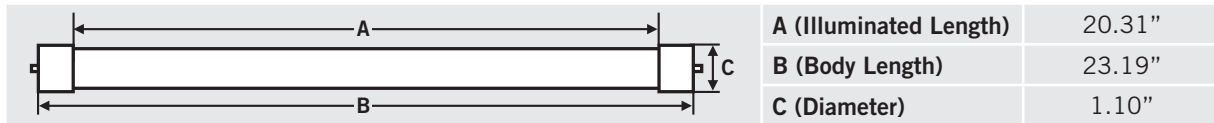

**NOMINAL LENGTH: 24"    BASE TYPE: G13 (Medium Bi-Pin)**

### ORDERING INFORMATION

ORDER CODE	PACKAGING STYLE	PACK QTY.	ITEM STATUS
KT-LED7T8-24GC-840-D-CP	Carton Pack (Egg Crate Packaging)	25	Quick Ship
KT-LED7T8-24GC-840-D-DP	Distributor Pack (Individual Cartons)	12	Quick Ship

### CATALOG NUMBER BREAKDOWN

# KT-LED7T8-24GC-840-D-CP

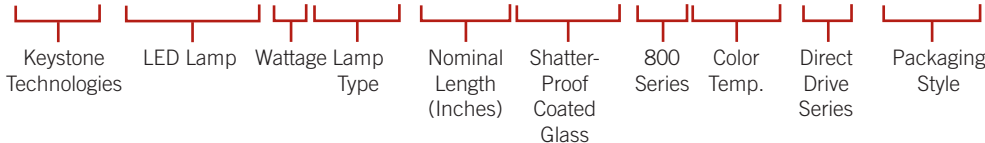



# KT-LED7T8-24GC-840-D

## T8 LED LAMP

### DESCRIPTION

7W T8 LED | 4000K | >83 CRI | High Efficiency



<b>LAMP TYPE:</b> Linear
<b>BULB TYPE:</b> T8 LED
<b>BASE TYPE:</b> G13 (Medium Bi-Pin)
<b>WATTAGE:</b> 7W
<b>COLOR TEMPERATURE:</b> 4000K
<b>COLOR RENDERING INDEX (CRI):</b> >83
<b>WARRANTY:</b> 5 Years



### PRODUCT FEATURES

- Replacement for Conventional Fluorescent Lamp
- 50,000+ Hour Lifetime
- Environmentally Friendly: No Mercury Used
- Instant Startup
- Frosted Lens Eliminates Pixelation
- UL Classified; Listed on DLC Qualified Product List
- Operating Temperature: -20°C/-4°F to 45°C/113°F

- Integral Driver (Isolated), Eliminates the Need for External Driver or Ballast
- 110+ Lumens per Watt
- Improved Lamp Durability with Shatterproof Coated Glass, designed to pass drop tests of 6' on hard surface
- ETL Sanitation Listed NSF/ANSI Standard 2 - Food Equipment, Splash Zone (Not for Direct Food Zone without additional fixture considerations)

### OPERATING SPECIFICATIONS

#### ELECTRICAL CHARACTERISTICS

Input Voltage	Power Consumption	Power Factor	Input Current
120-277Vac	7W	>0.9	0.06A @ 120V 0.03A @ 277V

#### PHOTOMETRIC CHARACTERISTICS

Color Temperature (CCT)	4000K
Luminous Flux	900 lm
Color Rendering Index (CRI)	>83
Efficacy	129 lm/W
Beam Angle	240°
Visible Light Area	325°

#### RATED LIFE

L70 (Hours)	50,000
-------------	--------

#### SPECTRAL DISTRIBUTION

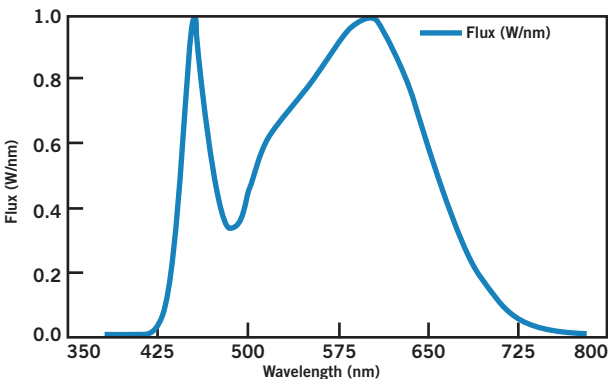

#### POLAR CANDELA DISTRIBUTION

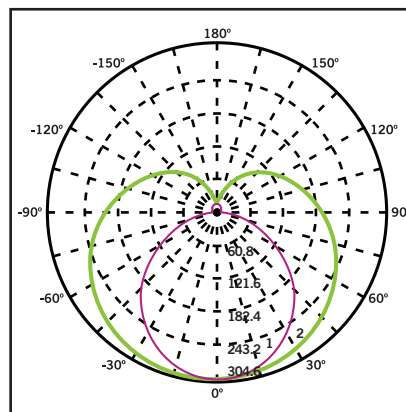

Maximum Candela = 1248.55  
Located at Horizontal Angle = 0,  
Vertical Angle 0

1. Violet Vertical Plane through Horizontal Angles (90-270)
2. Green Vertical Plane through Horizontal Angles (0-180)



# KT-LED7T8-24GC-840-D

## T8 LED LAMP

### WIRING DIAGRAMS

1. Cut all existing connections to ballast as shown below and remove ballast.

#### Typical Ballast Configurations:

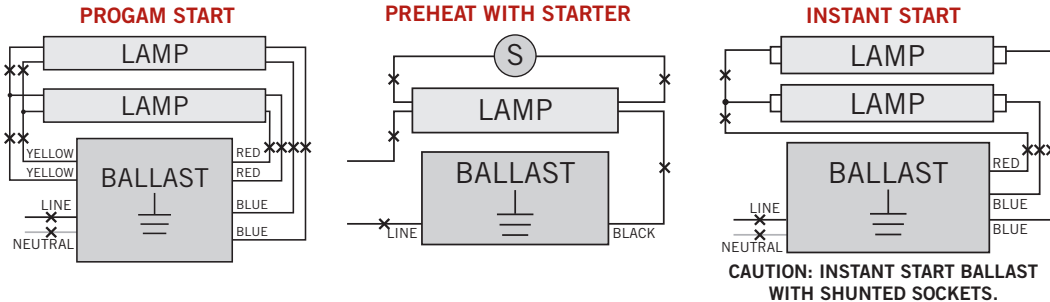

2. Re-wire fixture as shown below.

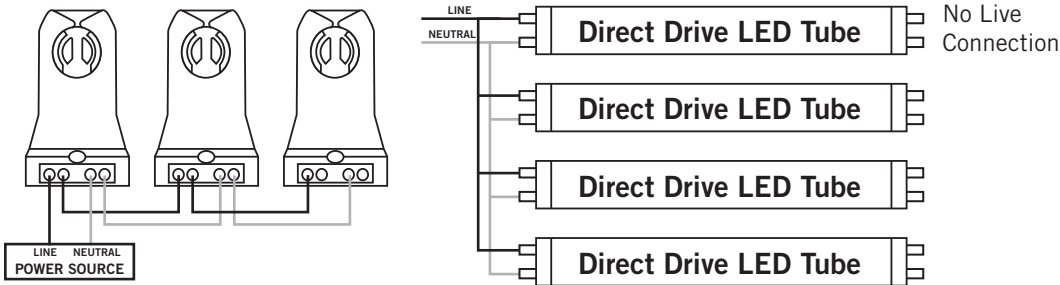

**Typical Non-Shunted Lampholder**

Connect wires directly to these terminals

**CAUTION: Use only non-shunted lampholders.**

Do not install product in a fixture with shunted lampholders (found in all fixtures using instant start ballasts). If the current lampholders are shunted, remove them and replace them with non-shunted lampholders. Make new connections directly to terminals as indicated above.

Keystone can provide any style replacement lampholders.  
Call us at 800-464-2680.

### PHYSICAL CHARACTERISTICS

#### LAMP DIMENSIONS

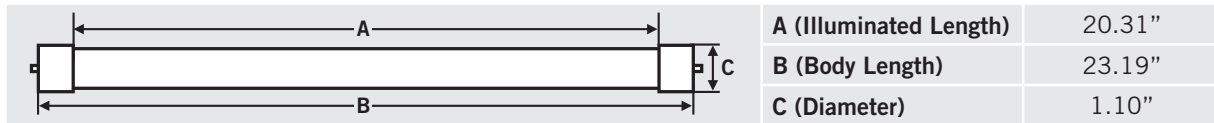

**NOMINAL LENGTH: 24"    BASE TYPE: G13 (Medium Bi-Pin)**

### ORDERING INFORMATION

ORDER CODE	PACKAGING STYLE	PACK QTY.	ITEM STATUS
KT-LED7T8-24GC-840-D-CP	Carton Pack (Egg Crate Packaging)	25	Quick Ship
KT-LED7T8-24GC-840-D-DP	Distributor Pack (Individual Cartons)	12	Quick Ship

### CATALOG NUMBER BREAKDOWN

# KT-LED7T8-24GC-840-D-CP

