

## Maestro Occupancy Sensing Switch

The Lutron Maestro Occupancy sensing switch combines a Maestro switch with a passive infrared occupancy or vacancy sensor. The sensor detects the heat from occupants moving within an area to determine whether the space is occupied. Based on the feedback from the sensor, the occupancy sensing switch will adjust the load accordingly.

### Features

- Passive infrared sensors with exclusive Lutron XCT Technology for fine motion detection
- 180° sensor field-of-view
- Up to 30 ft x 30 ft (9 m x 9 m) [900 ft<sup>2</sup> (81 m<sup>2</sup>)] major motion coverage and 20 ft x 20 ft (6 m x 6 m) [400 ft<sup>2</sup> (36 m<sup>2</sup>)] minor motion coverage
- Occupancy version can be set to Auto-ON / Auto-OFF or Manual-ON / Auto-OFF
- Vacancy version available to meet CA Title 24 requirements
- Adjustable timeout (1, 5, 15, or 30 minutes) and high/low sensitivity adjustment
- Occupancy sensing switch loads: incandescent, halogen, ELV, MLV, CFL, LED, magnetic fluorescent, electronic fluorescent, and fan.

**Note:** "XX" in model number represents color/finish code.

### Models available

- MS-OPS2-XX<sup>1</sup>
- MS-OPS2H-XX-C<sup>2</sup>
- MS-OPS5M-XX<sup>3</sup>
- MS-OPS5MH-XX-C<sup>2</sup>
- MS-OPS6M2-DV-XX
- MS-OPS6M2N-DV-XX
- UMS-OPS6M-DV-XX
- MS-VPS2-XX<sup>1</sup>
- MS-VPS5M-XX<sup>3</sup>
- MS-VPS6M2-DV-XX
- MS-VPS6M2N-DV-XX
- UMS-VPS6M-DV-XX

<sup>1</sup> For clamshell packaging, add an "H" after the "2". Available in AL, IV, LA, and WH.

<sup>2</sup> Clamshell packaged product for Canada. Available in AL, IV, LA, and WH.

<sup>3</sup> For clamshell packaging, add an "H" after the "M". Available in AL, IV, LA, and WH.

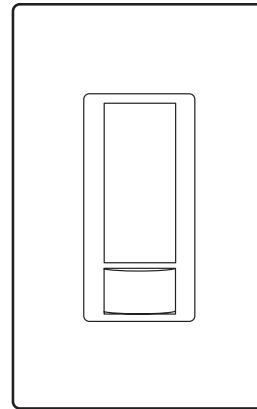

MS-OPS2  
MS-OPS2H-XX-C  
MS-OPS5M  
MS-OPS5MH-XX-C  
MS-OPS6M2-DV  
MS-OPS6M2N-DV  
MS-VPS2  
MS-VPS5M  
MS-VPS6M2-DV  
MS-VPS6M2N-DV

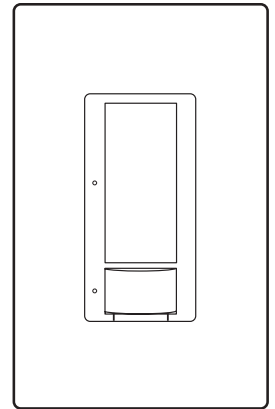

UMS-OPS6M-DV  
UMS-VPS6M-DV

<b>Job Name:</b>	<b>Model Numbers:</b>
<b>Job Number:</b>	

## Specifications

### Regulatory Approvals

- UL® Listed to U.S. and Canadian safety requirements.
- NOM Certification (MS- models only).

### Power

- 120 V~ 50/60 Hz<sup>1</sup>
- 120–277 V~ 50/60 Hz<sup>1</sup>

### Key Design Features

- All lighting loads
- Crush/tamper resistant lens
- Smart ambient light detection
- Adaptive switching algorithm for extended relay life
- XCT Technology for fine motion detection
- Lutron patented Softswitch

### Environment

- Ambient operating temperature: 32 °F to 104 °F (0 °C to 40 °C), 0%–90% humidity, non-condensing. Indoor use only.

### Warranty

- 5-Year Limited Warranty. For additional Warranty information, please visit [www.lutron.com/TechnicalDocumentLibrary/Sensor\\_Warranty.pdf](http://www.lutron.com/TechnicalDocumentLibrary/Sensor_Warranty.pdf)

### Additional Information

- When using MS-OPS2, MS-OPS5M, MS-OPS6M2-DV, MS-VPS2, MS-VPS5M, or MS-VPS6M2-DV on GFI-controlled circuits, please see Lutron P/N 048440 on [www.lutron.com](http://www.lutron.com)
- For Maestro Occupancy sensing dimmer models, please see Lutron P/N 369270 on [www.lutron.com](http://www.lutron.com)
- For use with MA-AS, MSC-AS, MA-AS-277, or MSC-AS-277 to control the load from more than two locations, please see Lutron P/N 048435 on [www.lutron.com](http://www.lutron.com)
- For more information, please see [www.lutron.com/occvacsensors](http://www.lutron.com/occvacsensors)
- Lutron Customer Assistance: 1.844.LUTRON1

## Advanced Features

### Switching

- Standard zero cross—maximizes relay life by switching at the point of minimum energy on the AC power curve
- Adaptive zero cross—maximizes relay life by switching at the point of minimum energy on the AC power curve. Actively adapts to variations in relay timing
- Lutron Patented Softswitch circuit—eliminates arcing at mechanical contacts when loads are switched. Extends relay life to an average of 1,000,000 cycles (on/off) for resistive, capacitive, or inductive sources

### XCT Technology

Advanced sensing technology for fine motion detection ensures that the lights stay on while the room is occupied, and that the sensor does not turn on falsely when there is no occupancy in the room. For more information, see [www.lutron.com/TechnicalDocumentLibrary/white%20paper%20XCT%204-23-09%20B.pdf](http://www.lutron.com/TechnicalDocumentLibrary/white%20paper%20XCT%204-23-09%20B.pdf)

<sup>1</sup> Maximum current ratings for individual models are provided in the **Selection Matrix** on page 4.

<p><b>Job Name:</b></p> <p><b>Job Number:</b></p>	<p><b>Model Numbers:</b></p>
--	------------------------------

## Custom Settings

### Ambient Light Detection

Lights turn on only if natural light in room is low.

- Smart—Ambient light threshold adjusts precisely to the user’s preference.

Instructions: If switch turns on when there is enough natural light, or if switch does not turn on when there is not enough natural light, press the large button within 5 seconds of entering the room. Over time, this interaction will “teach” the switch your preferred setting.

- Presets—high, medium, low, and disabled.

### Sensor Operation

- Occupancy/Vacancy: Auto-ON / Auto-OFF or Manual-ON / Auto-OFF
- Vacancy only: Manual-ON / Auto-OFF only

### Timeout Options

(See **Additional Features** on page 5 for default settings)

- 1 Minute
- 5 Minutes
- 15 Minutes
- 30 Minutes

### Sensitivity Options

- High sensitivity (default)
- Low sensitivity

### Auto-ON Options

(MS-OPS and UMS-OPS only)

- Occupancy (default): Auto-ON / Auto-OFF
- Vacancy\*: Manual-ON / Auto-OFF
- Low Light: Lights turn on only if needed (if ambient light is below threshold)

\* There is a 15-second grace period that begins when the lights are automatically turned off, during which the lights will automatically turn back on in response to motion. This grace period is provided as a safety and convenience feature in the event that the lights turn off while the room is still occupied, so that the user does not need to manually turn the lights back on. After 15 seconds, the grace period expires and the lights must be manually turned on.

### Manual Off-While-Occupied Options

(MS-OPS and UMS-OPS only — see **Additional Features** on page 5 for default setting)

- Enabled
  - When the Occupancy sensing switch is manually turned off, the Occupancy sensing switch will not turn the lights back on automatically while the room is occupied.
  - Once the room is vacated, the Auto-ON feature returns to normal operation after the timeout period has expired.
  - This may be the preference in conference rooms or classrooms while viewing presentations. This feature requires motion to keep the lights off.
- Disabled
  - When the Occupancy sensing switch is manually turned off, the Auto-ON feature will return to normal operation after 25 seconds.
  - This may be the preference if the user always wants the lights to turn on upon entering and the lights to turn off when the room is vacant.

Job Name:	Model Numbers:
Job Number:	

### Selection Matrix

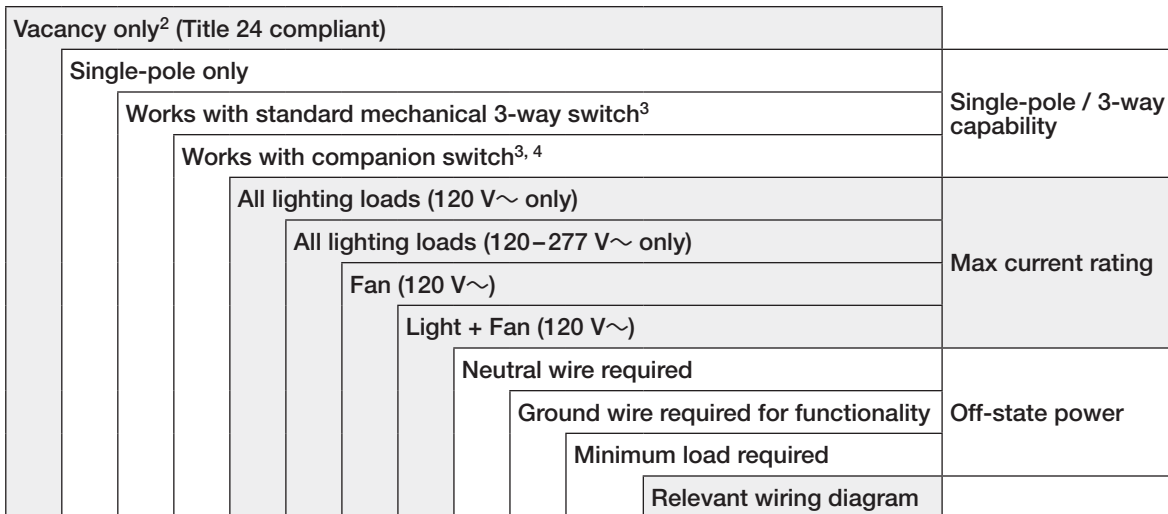

**Model Number<sup>1</sup>**

MS-OPS2-XX		✓			2 A					✓		1
MS-OPS2H-XX-C		✓			2 A					✓		1
MS-OPS5M-XX			✓	✓	5 A		3 A	3 A		✓		2, 3, 5
MS-OPS5MH-XX-C			✓	✓	5 A		3 A	3 A		✓		2, 3, 5
MS-OPS6M2-DV-XX			✓	✓		6 A	3 A	3 A		✓		2–6
MS-OPS6M2N-DV-XX			✓	✓		6 A	3 A	3 A	✓			7–11
UMS-OPS6M-DV-XX <sup>5</sup>				✓		6 A	3 A	3 A			25 W	12–17
MS-VPS2-XX	✓	✓			2 A					✓		1
MS-VPS5M-XX	✓		✓	✓	5 A		3 A	3 A		✓		2, 3, 5
MS-VPS6M2-DV-XX	✓		✓	✓		6 A	3 A	3 A		✓		2–6
MS-VPS6M2N-DV-XX	✓		✓	✓		6 A	3 A	3 A	✓			7–11
UMS-VPS6M-DV-XX <sup>5</sup>	✓			✓		6 A	3 A	3 A			25 W	12–17

- <sup>1</sup> XX in model number represents color/finish code.
- <sup>2</sup> Occupancy sensors can be configured as Auto-ON / Auto-OFF or Manual-ON / Auto-OFF. Vacancy sensors are configured as Manual-ON / Auto-OFF only.
- <sup>3</sup> Standard mechanical 3-way switch cannot be combined with companion switch.
- <sup>4</sup> Companion switch MA-AS, MSC-AS, MA-AS-277, or MSC-AS-277 is required for multi-location installations (more than two locations controlling the same lighting circuit). Up to nine companion switches may be connected.
- <sup>5</sup> BAA-compliant models.

Job Name:	Model Numbers:
Job Number:	

### Additional Features

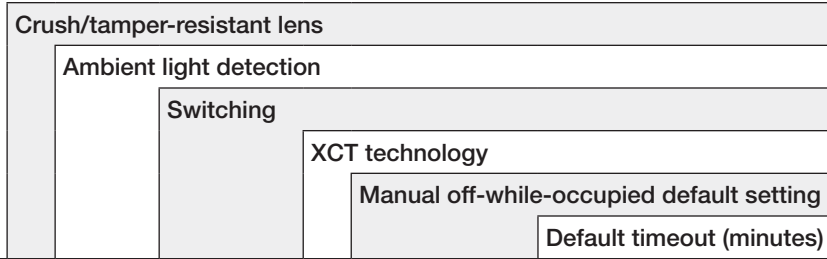

Model Number <sup>1</sup>						
MS-OPS2-XX		Smart	Standard	✓	Disabled	5
MS-OPS2H-XX-C		Smart	Standard	✓	Disabled	5
MS-OPS5M-XX		Smart	Standard	✓	Disabled	5
MS-OPS5MH-XX-C		Smart	Standard	✓	Disabled	5
MS-OPS6M2-DV-XX	✓	Smart	Adaptive	✓	Enabled	15
MS-OPS6M2N-DV-XX	✓	Smart	Adaptive	✓	Enabled	15
UMS-OPS6M-DV-XX		Presets	Softswitch	✓	Enabled	5
MS-VPS2-XX		Smart	Standard	✓		5
MS-VPS5M-XX		Smart	Standard	✓		5
MS-VPS6M2-DV-XX	✓	Smart	Adaptive	✓		15
MS-VPS6M2N-DV-XX	✓	Smart	Adaptive	✓		15
UMS-VPS6M-DV-XX		Presets	Softswitch	✓		5

<sup>1</sup> XX in model number represents color/finish code.

Job Name:	Model Numbers:
Job Number:	

### Occupancy Sensing Switch Placement and Operation

- The ability of the Occupancy sensing switch to detect motion requires line-of-sight of room occupants. The Occupancy sensing switch must have an unobstructed view of the room.
- Hot objects and moving air currents can affect the performance of the Occupancy sensing switch.
- The performance of the Occupancy sensing switch depends on a temperature differential between the ambient room temperature and that of room occupants. Warmer rooms may reduce the ability of the Occupancy sensing switch to detect occupants.

#### Definitions

**Major motion:** movement of a person entering or passing through an area.

**Minor motion:** movement of a person occupying an area and engaging in small activities (e.g., reaching for a telephone, turning the pages of a book, opening a file folder, picking up a coffee cup).

#### NEMA WD7 Coverage

 Major motion coverage: 900 ft<sup>2</sup> (81 m<sup>2</sup>)

 Minor motion coverage: 400 ft<sup>2</sup> (36 m<sup>2</sup>)

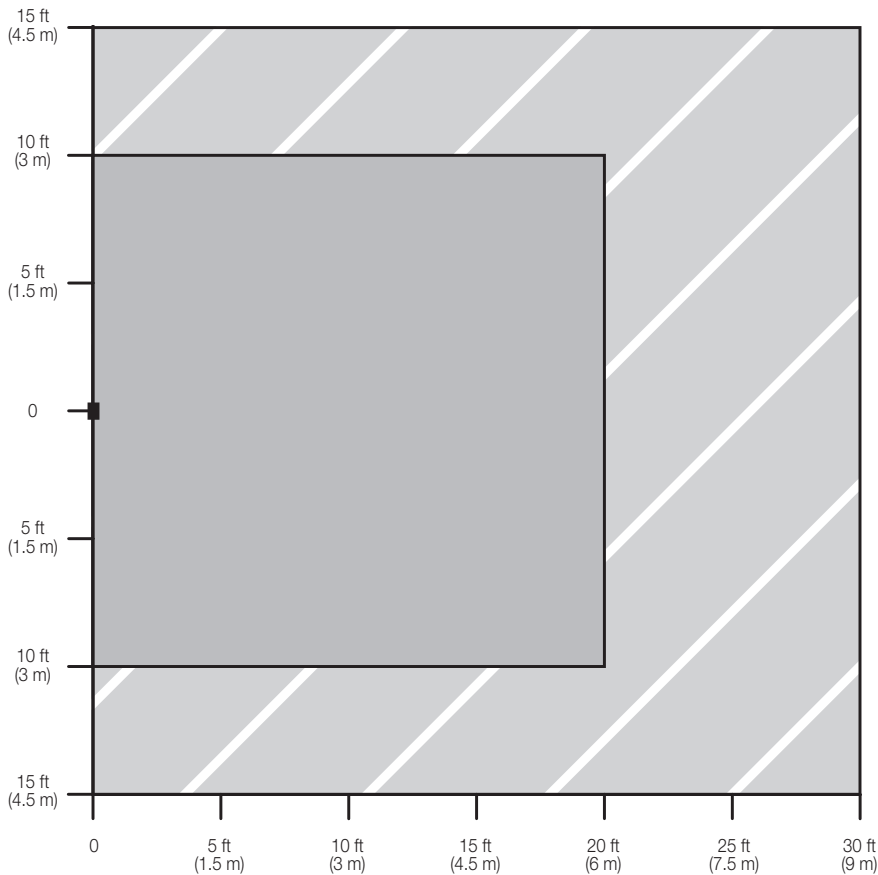

#### Horizontal Beam Diagram

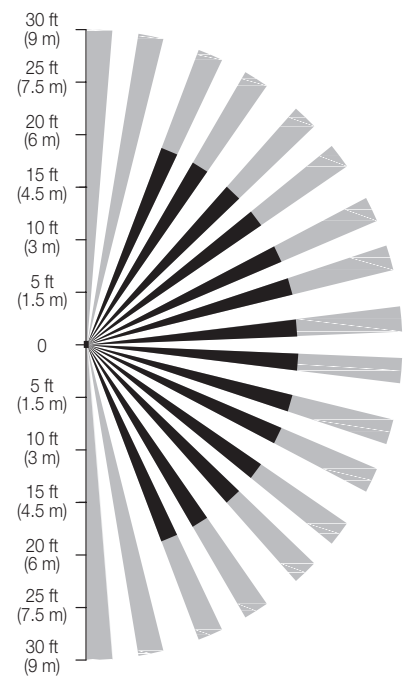

#### Vertical Beam Diagram

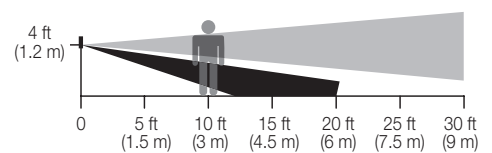

<b>Job Name:</b>	<b>Model Numbers:</b>
<b>Job Number:</b>	

### Dimensions

Measurements shown as: in (mm).

Front View

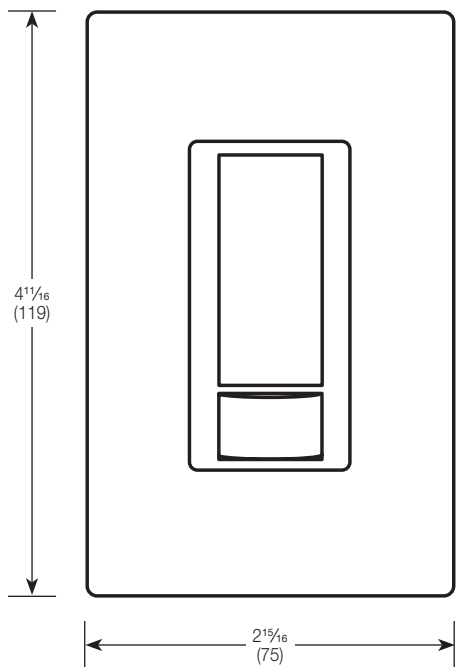

Side View



### Ganging

When ganging with other controls in the same wallbox, remove inside fins (UMS-OPS6M-DV and UMS-VPS6M-DV only).

Each control has inside fins removed



Middle of Gang control has all fins removed



Do NOT remove outside fins on End of Gang controls

Job Name:	Model Numbers:
Job Number:	

### Mounting

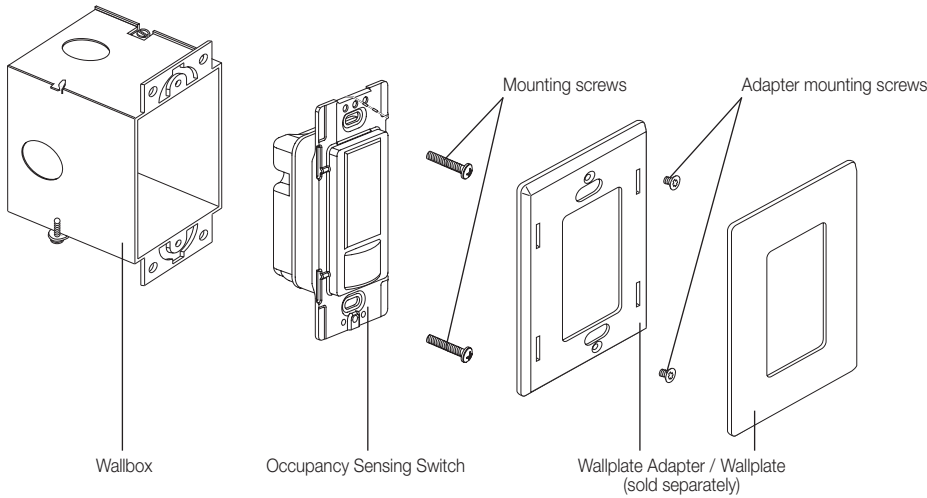

### Operation



- MS-OPS2
- MS-OPS5M
- MS-OPS6M2-DV
- MS-OPS6M2N-DV
- MS-VPS2
- MS-VPS5M
- MS-VPS6M2-DV
- MS-VPS6M2N-DV

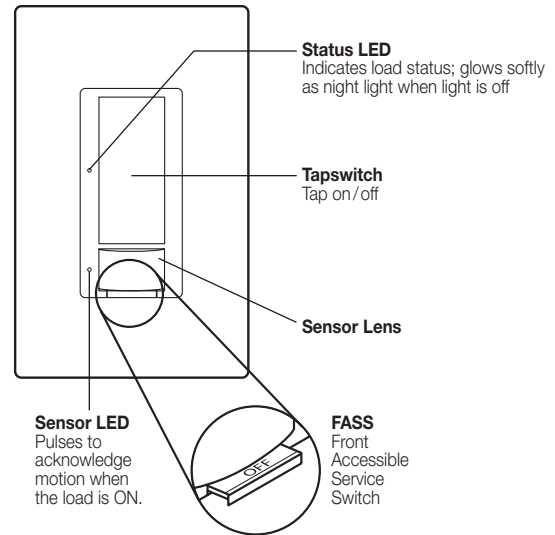

- UMS-OPS6M-DV
- UMS-VPS6M-DV

**IMPORTANT NOTICE**

**FASS – Front Accessible Service Switch –**

To service load, remove power by pulling the FASS switch out completely on either the Dimmer or Companion Dimmer. After servicing load, push the FASS switch back in fully to restore power to the control.

<b>Job Name:</b>	<b>Model Numbers:</b>
<b>Job Number:</b>	



## Wiring Diagrams

### Wiring Diagram 1

Single Location Installation (120 V~)  
-OPS2 and -VPS2

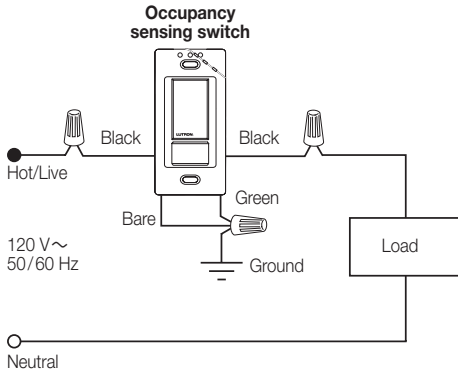

### Wiring Diagram 2

Single Location Installation (120 V~)<sup>1</sup>  
-OPS5M, -OPS6M2-DV, -VPS5M, -VPS6M2-DV

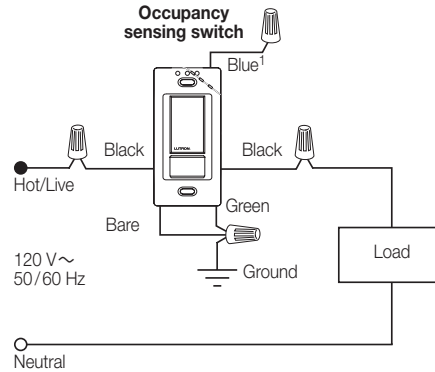

### Wiring Diagram 3

3-way Installation with Standard Mechanical Switch (120 V~)<sup>2, 3</sup>  
-OPS5M, -OPS6M2-DV, -VPS5M, -VPS6M2-DV

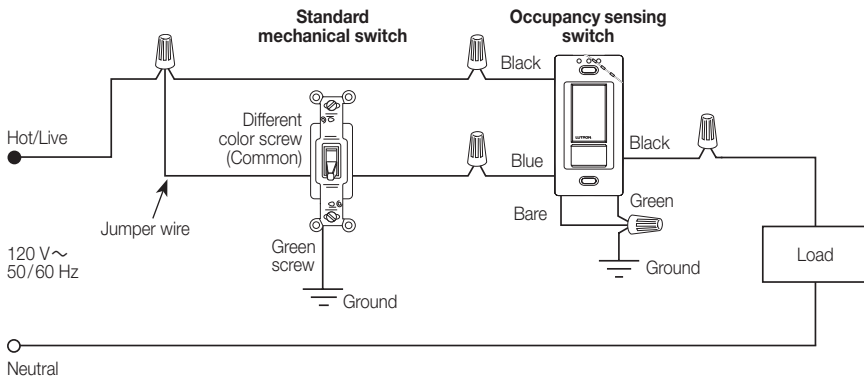

OR

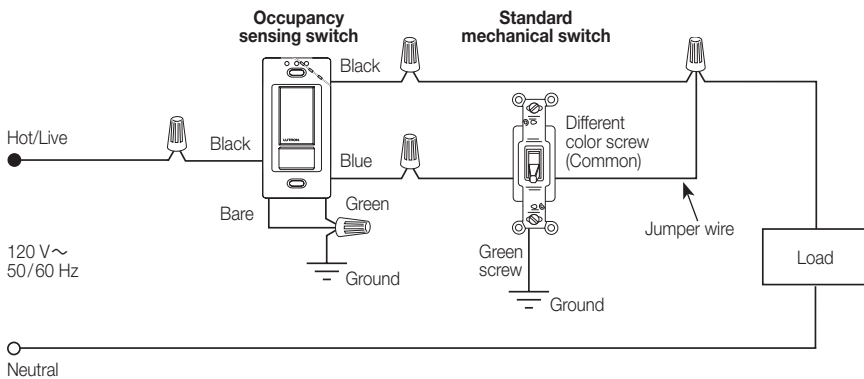

- <sup>1</sup> When using controls in single location installations, tighten the blue terminal or cap blue wire. Do not connect the blue terminal/wire to any other wire or to ground.
- <sup>2</sup> Only one Occupancy sensing switch can be used per multi-location circuit.
- <sup>3</sup> A single standard mechanical 3-way switch or up to 9 companion switches may be connected to most Occupancy sensing switches. Standard mechanical 3-way switch cannot be combined with companion switch. Total blue terminal wire length may be up to 150 ft (46 m).

Continued on next page...

<b>Job Name:</b>	<b>Model Numbers:</b>
<b>Job Number:</b>	

Wiring Diagrams (continued)

Wiring Diagram 4

3-way Installation with Standard Mechanical Switch (277 V~)<sup>1, 2, 3</sup>  
-OPS6M2-DV, -VPS6M2-DV

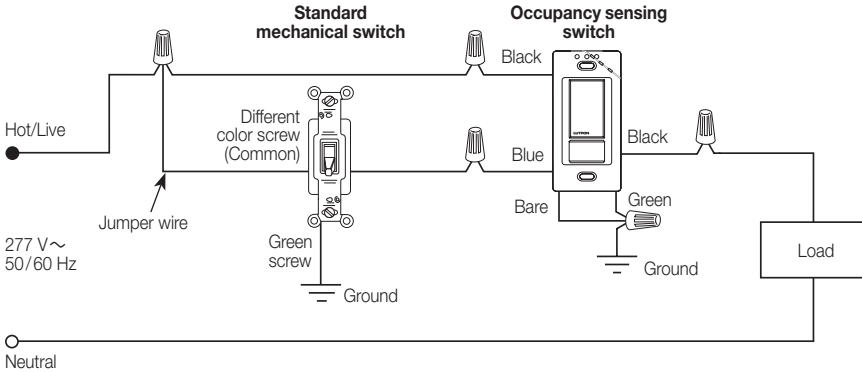

OR

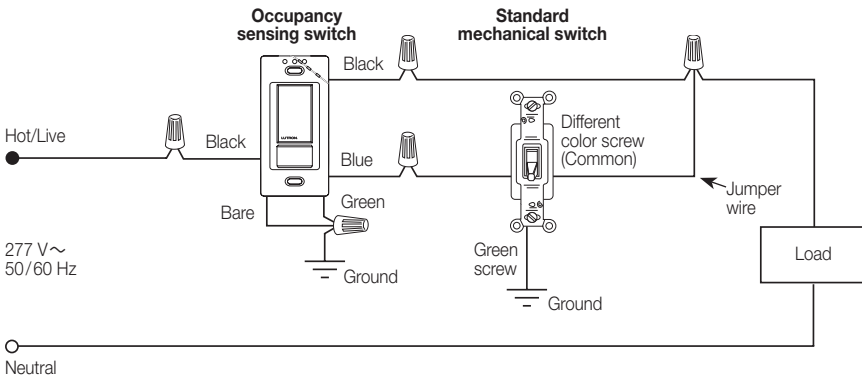

Wiring Diagram 5

Multi-Location Installation (120 V~)<sup>1, 2, 4</sup>  
-OPS5M, -OPS6M2-DV, -VPS5M, -VPS6M2-DV with MA-AS or MSC-AS

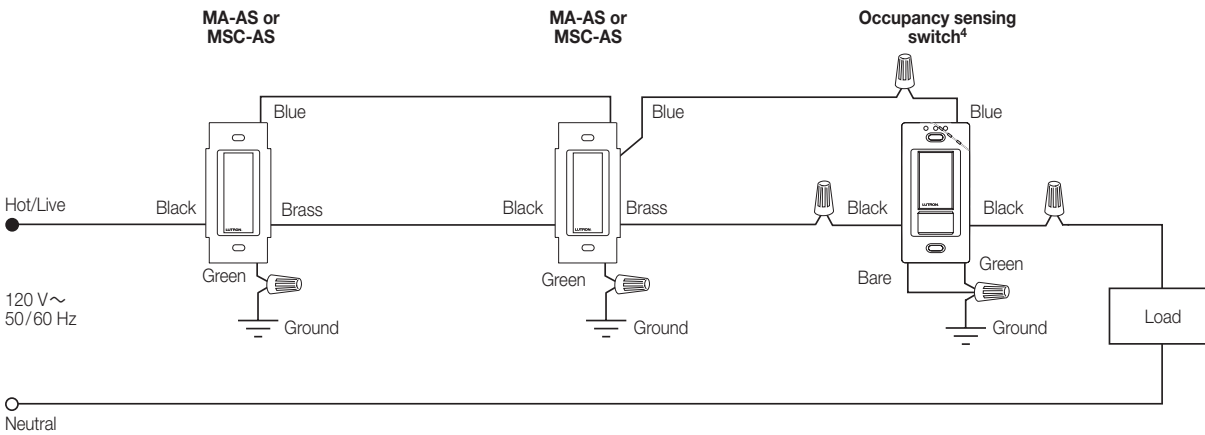

- <sup>1</sup> A single standard mechanical 3-way switch or up to 9 companion switches may be connected to most Occupancy sensing switches. Standard mechanical 3-way switch cannot be combined with companion switch. Total blue terminal wire length may be up to 150 ft (46 m).
- <sup>2</sup> Only one Occupancy sensing switch can be used per multi-location circuit.
- <sup>3</sup> Fan load applies to 120 V~ only (not for 277 V~).
- <sup>4</sup> Occupancy sensing switch can be installed in any location.

Continued on next page...

Job Name:	Model Numbers:
Job Number:	

### Wiring Diagrams *(continued)*

#### Wiring Diagram 6

#### Multi-Location Installation (277 V~)<sup>1, 2, 3, 4</sup>

-OPS6M2-DV, -VPS6M2-DV with MA-AS-277 or MSC-AS-277

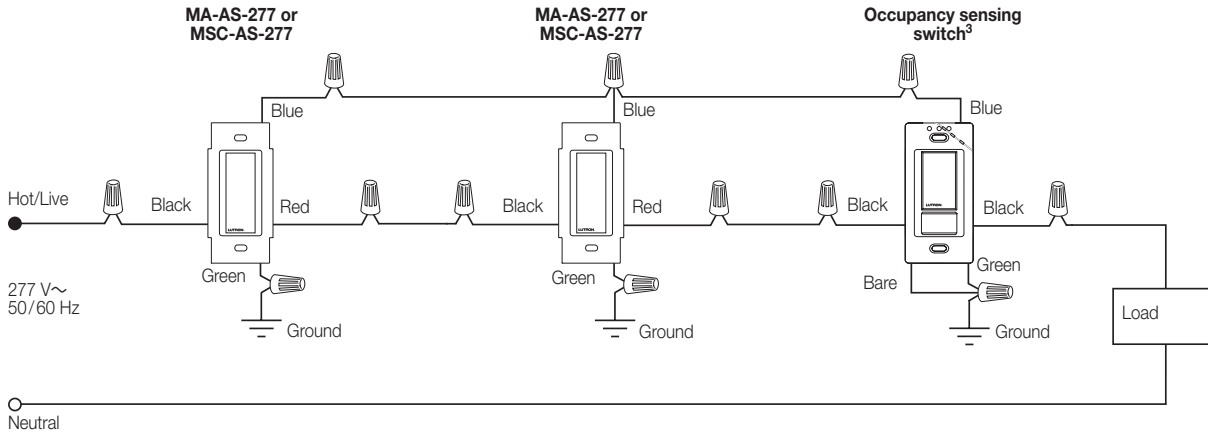

- <sup>1</sup> A single standard mechanical 3-way switch or up to 9 companion switches may be connected to most Occupancy sensing switches. Standard mechanical 3-way switch cannot be combined with companion switch. Total blue terminal wire length may be up to 150 ft (46 m).
- <sup>2</sup> Only one Occupancy sensing switch can be used per multi-location circuit.
- <sup>3</sup> Occupancy sensing switch can be installed in any location.
- <sup>4</sup> Fan load applies to 120 V~ only (not for 277 V~).

*Continued on next page...*

Job Name:	Model Numbers:
Job Number:	

### Wiring Diagrams *(continued)*

#### Wiring Diagram 7

##### Single Location Installation (120-277 V~)<sup>1, 2</sup>

-OPS6M2N-DV, -VPS6M2N-DV



#### Wiring Diagram 8

##### 3-way Installation with Standard Mechanical Switch (120 V~)<sup>3, 4</sup>

-OPS6M2N-DV, -VPS6M2N-DV

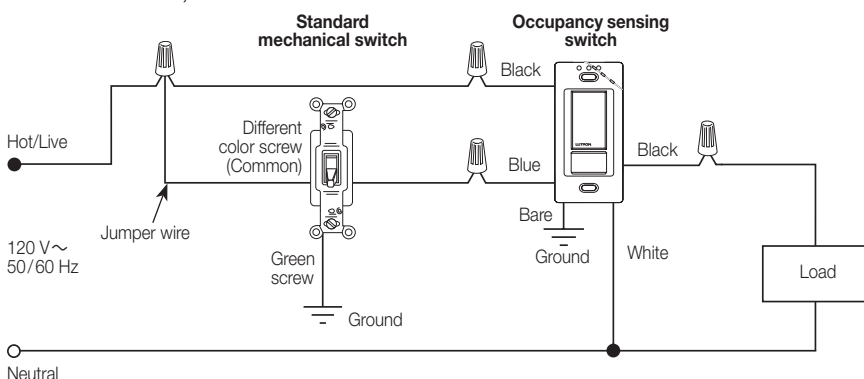

OR

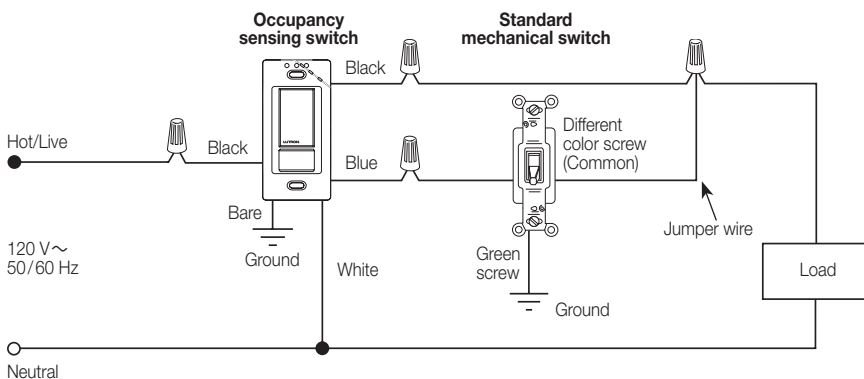

- <sup>1</sup> When using controls in single location installations, tighten the blue terminal or cap blue wire. Do **NOT** connect the blue terminal/wire to any other wire or to ground.
- <sup>2</sup> Fan load applies to 120 V~ only (not for 277 V~).
- <sup>3</sup> Only one Occupancy sensing switch can be used per multi-location circuit.
- <sup>4</sup> A single standard mechanical 3-way switch or up to 9 companion switches may be connected to most Occupancy sensing switches. Standard mechanical 3-way switch cannot be combined with companion switch. Total blue terminal wire length may be up to 150 ft (46 m).

*Continued on next page...*

<b>Job Name:</b>	<b>Model Numbers:</b>
<b>Job Number:</b>	

### Wiring Diagrams (continued)

#### Wiring Diagram 9

#### 3-way Installation with Standard Mechanical Switch (277 V~)<sup>1, 2, 3</sup>

-OPS6M2N-DV, -VPS6M2N-DV

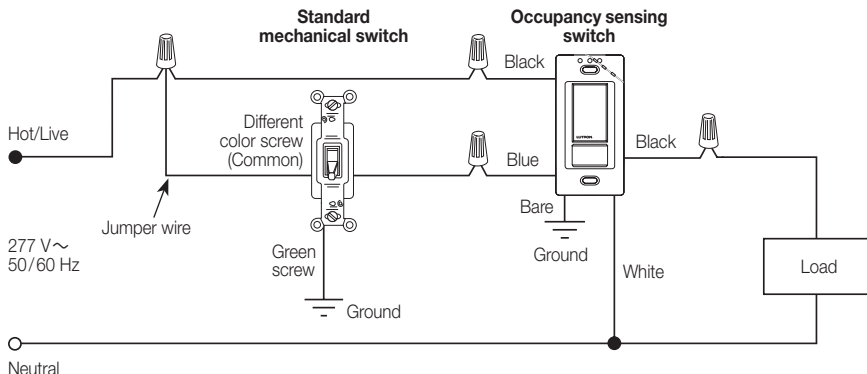

OR

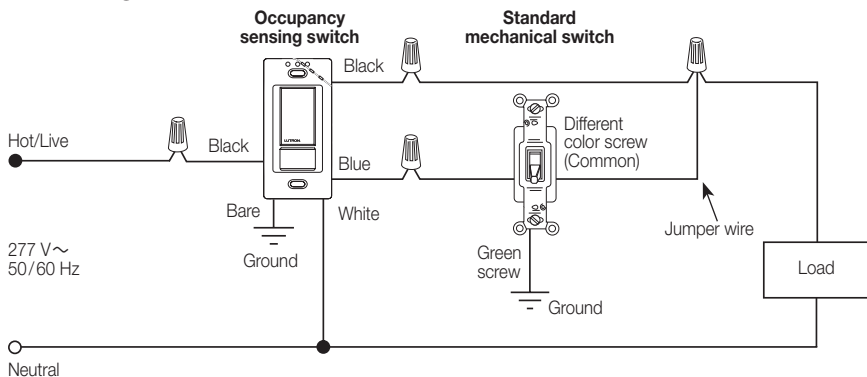

- <sup>1</sup> Only one Occupancy sensing switch can be used per multi-location circuit.
- <sup>2</sup> A single standard mechanical 3-way switch or up to 9 companion switches may be connected to most Occupancy sensing switches. Standard mechanical 3-way switch cannot be combined with companion switch. Total blue terminal wire length may be up to 150 ft (46 m).
- <sup>3</sup> Fan load applies to 120 V~ only (not for 277 V~).

Continued on next page...

Job Name:	Model Numbers:
Job Number:	

### Wiring Diagrams *(continued)*

#### Wiring Diagram 10

##### Multi-Location Installation (120 V~)<sup>1, 2, 3</sup>

-OPS6M2N-DV, -VPS6M2N-DV with MA-AS or MSC-AS

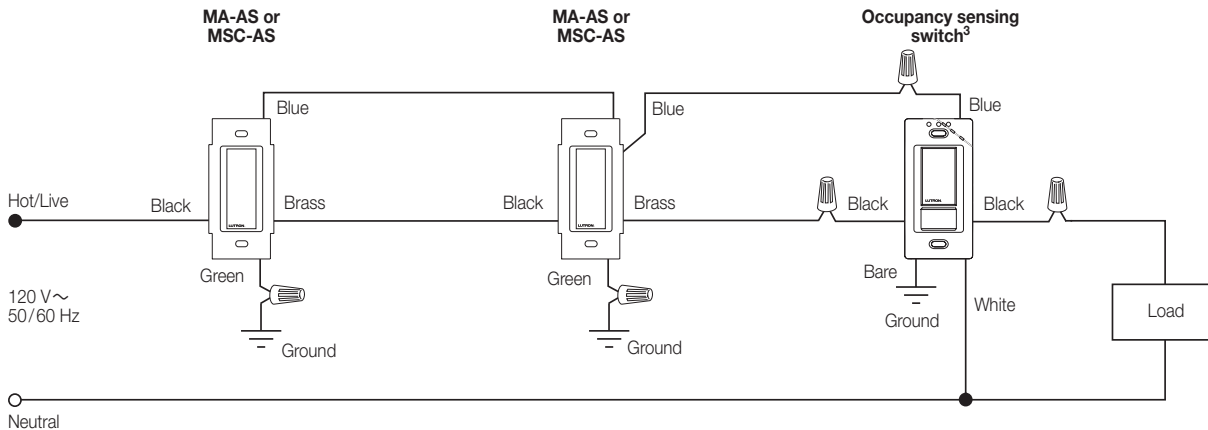

#### Wiring Diagram 11

##### Multi-Location Installation (277 V~)<sup>1, 2, 3, 4</sup>

-OPS6M2N-DV, -VPS6M2N-DV with MA-AS-277 or MSC-AS-277

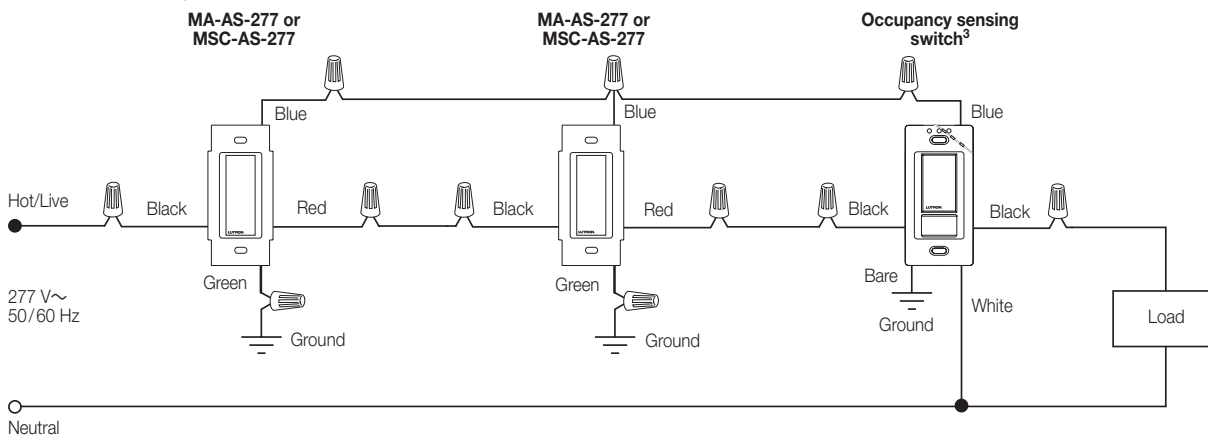

- <sup>1</sup> A single standard mechanical 3-way switch or up to 9 companion switches may be connected to most Occupancy sensing switches. Standard mechanical 3-way switch cannot be combined with companion switch. Total blue terminal wire length may be up to 150 ft (46 m).
- <sup>2</sup> Only one Occupancy sensing switch can be used per multi-location circuit.
- <sup>3</sup> Occupancy sensing switch can be installed in any location.
- <sup>4</sup> Fan load applies to 120 V~ only (not for 277 V~).

Continued on next page...

<b>Job Name:</b>	<b>Model Numbers:</b>
<b>Job Number:</b>	

### Wiring Diagrams (continued)

#### Wiring Diagram 12

Single Location Installation<sup>1, 2</sup>  
-OPS6M-DV and -VPS6M-DV

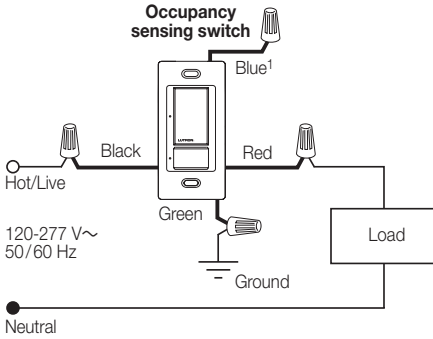

#### Wiring Diagram 13

Single Location Installation with Shunt Capacitor<sup>1, 2, 3</sup>  
-OPS6M-DV and -VPS6M-DV

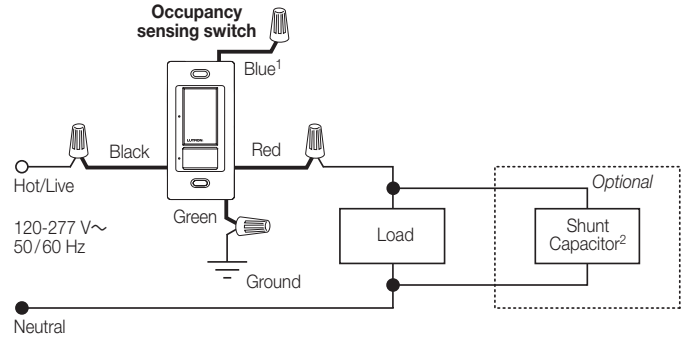

#### Wiring Diagram 14

Multi-Location Installation (120 V~)<sup>1, 4, 5, 6</sup>  
-OPS6M-DV and -VPS6M-DV with MA-AS or MSC-AS

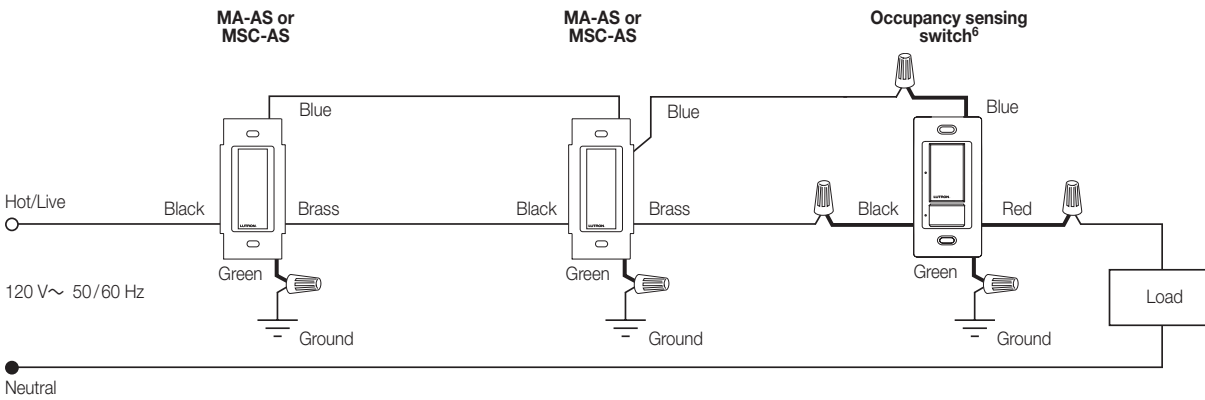

#### Wiring Diagram 15

Multi-Location Installation (277 V~)<sup>1, 2, 3, 4, 5, 6</sup>  
-OPS6M-DV and -VPS6M-DV with MA-AS-277 or MSC-AS-277

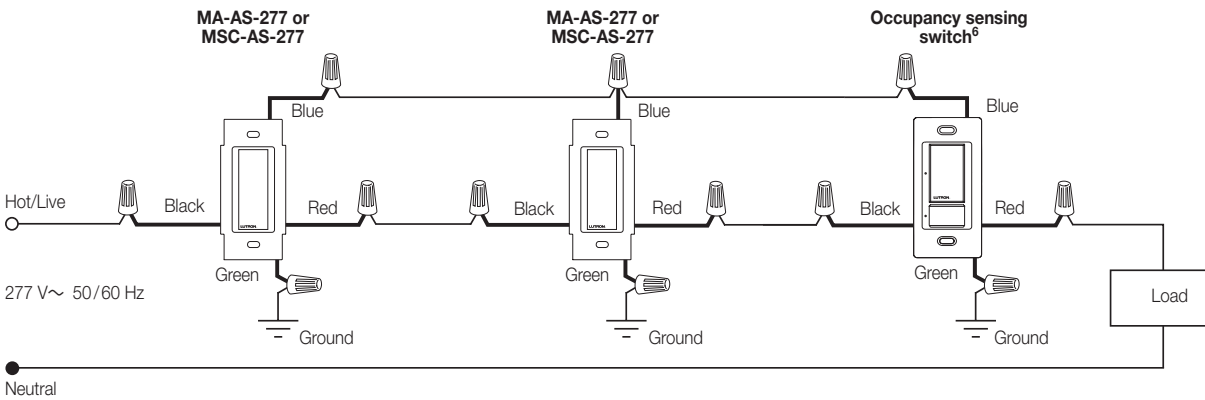

- <sup>1</sup> When using controls in single location installations, tighten the blue terminal or cap blue wire. Do not connect the blue terminal/wire to any other wire or to ground.
- <sup>2</sup> Fan load applies to 120 V~ only (not for 277 V~).
- <sup>3</sup> Optional shunt capacitor must be installed inside the load fixture or in a separate J-box.
- <sup>4</sup> Up to 9 companion switches may be connected to an Occupancy sensing switch. Total blue terminal wire length may be up to 250 ft (76 m).
- <sup>5</sup> Only one Occupancy sensing switch can be used per multi-location circuit.
- <sup>6</sup> Occupancy sensing switch can be installed in any location.

Continued on next page...

<b>Job Name:</b>	<b>Model Numbers:</b>
<b>Job Number:</b>	

Wiring Diagrams (continued)

Wiring Diagram 16

Multi-Location Installation with Shunt Capacitor (120 V~)<sup>1, 2, 3, 4</sup>

-OPS6M-DV and -VPS6M-DV with MA-AS or MSC-AS

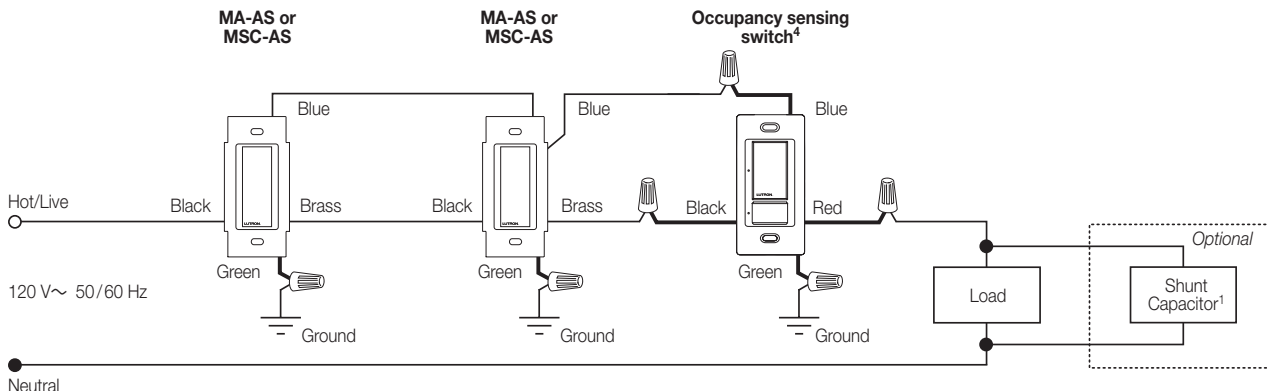

Wiring Diagram 17

Multi-Location Installation with Shunt Capacitor (277 V~)<sup>1, 2, 3, 4, 5</sup>

-OPS6M-DV and -VPS6M-DV with MA-AS-277 or MSC-AS-277

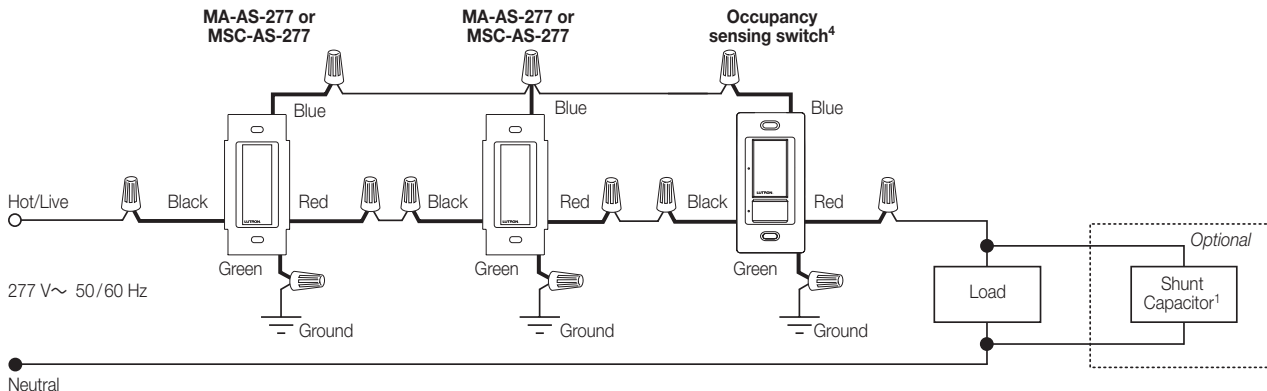

- <sup>1</sup> Optional shunt capacitor must be installed inside the load fixture or in a separate J-box.
- <sup>2</sup> Up to 9 companion switches may be connected to an Occupancy sensing switch. Total blue terminal wire length may be up to 250 ft (76 m)
- <sup>3</sup> Only one Occupancy sensing switch can be used per multi-location circuit.
- <sup>4</sup> Occupancy sensing switch can be installed in any location.
- <sup>5</sup> Fan load applies to 120 V~ only (not for 277 V~).

<b>Job Name:</b>	<b>Model Numbers:</b>
<b>Job Number:</b>	



## Colors and Finishes

### Gloss Finishes

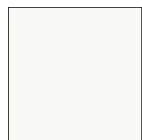

White  
WH



Ivory  
IV

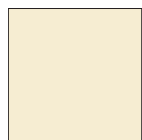

Almond  
AL

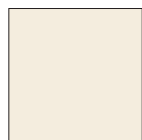

Light Almond  
LA

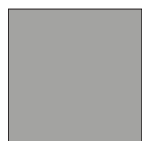

Gray  
GR



Brown  
BR



Black  
BL

### Satin Finishes



Hot  
HT



Merlot  
MR



Plum  
PL



Turquoise  
TQ



Taupe  
TP

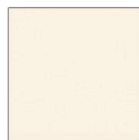

Eggshell  
ES



Biscuit  
BI



Snow  
SW



Palladium  
PD



Midnight  
MN



Sienna  
SI

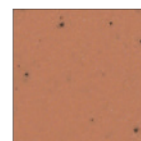

Terracotta  
TC

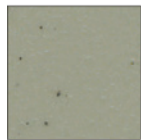

Greenbriar  
GB

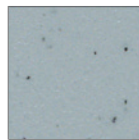

Bluestone  
BG

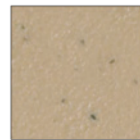

Mocha Stone  
MS

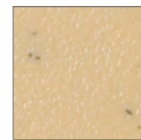

Goldstone  
GS



Desert Stone  
DS

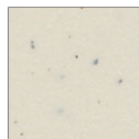

Stone  
ST



Limestone  
LS



Sea Glass  
SG

- Due to printing limitations, colors and finishes shown cannot be guaranteed to match actual product colors perfectly.
- Color chip keychains are available for more precise color matching:  
 Gloss Finishes: DG-CK-1  
 Satin Finishes: SC-CK-1

Lutron, Lutron, Maestro, and Softswitch are trademarks of Lutron Electronics Co., Inc., registered in the U.S. and other countries.

XCT and FASS are trademarks of Lutron Electronics Co., Inc.

## LUTRON SPECIFICATION SUBMITTAL

Page

<p><b>Job Name:</b></p> <p><b>Job Number:</b></p>	<p><b>Model Numbers:</b></p>
--	------------------------------

## Maestro Occupancy Sensing Switch

The Lutron Maestro Occupancy sensing switch combines a Maestro switch with a passive infrared occupancy or vacancy sensor. The sensor detects the heat from occupants moving within an area to determine whether the space is occupied. Based on the feedback from the sensor, the occupancy sensing switch will adjust the load accordingly.

### Features

- Passive infrared sensors with exclusive Lutron XCT Technology for fine motion detection
- 180° sensor field-of-view
- Up to 30 ft x 30 ft (9 m x 9 m) [900 ft<sup>2</sup> (81 m<sup>2</sup>)] major motion coverage and 20 ft x 20 ft (6 m x 6 m) [400 ft<sup>2</sup> (36 m<sup>2</sup>)] minor motion coverage
- Occupancy version can be set to Auto-ON / Auto-OFF or Manual-ON / Auto-OFF
- Vacancy version available to meet CA Title 24 requirements
- Adjustable timeout (1, 5, 15, or 30 minutes) and high/low sensitivity adjustment
- Occupancy sensing switch loads: incandescent, halogen, ELV, MLV, CFL, LED, magnetic fluorescent, electronic fluorescent, and fan.

**Note:** "XX" in model number represents color/finish code.

### Models available

- MS-OPS2-XX<sup>1</sup>
- MS-OPS2H-XX-C<sup>2</sup>
- MS-OPS5M-XX<sup>3</sup>
- MS-OPS5MH-XX-C<sup>2</sup>
- MS-OPS6M2-DV-XX
- MS-OPS6M2N-DV-XX
- UMS-OPS6M-DV-XX
- MS-VPS2-XX<sup>1</sup>
- MS-VPS5M-XX<sup>3</sup>
- MS-VPS6M2-DV-XX
- MS-VPS6M2N-DV-XX
- UMS-VPS6M-DV-XX

<sup>1</sup> For clamshell packaging, add an "H" after the "2". Available in AL, IV, LA, and WH.

<sup>2</sup> Clamshell packaged product for Canada. Available in AL, IV, LA, and WH.

<sup>3</sup> For clamshell packaging, add an "H" after the "M". Available in AL, IV, LA, and WH.

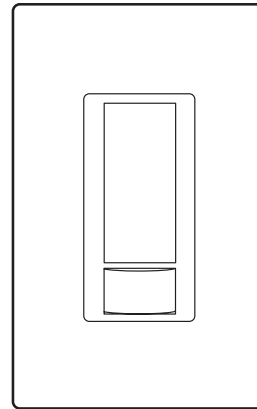

MS-OPS2  
MS-OPS2H-XX-C  
MS-OPS5M  
MS-OPS5MH-XX-C  
MS-OPS6M2-DV  
MS-OPS6M2N-DV  
MS-VPS2  
MS-VPS5M  
MS-VPS6M2-DV  
MS-VPS6M2N-DV

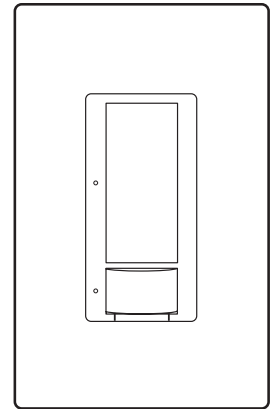

UMS-OPS6M-DV  
UMS-VPS6M-DV

<b>Job Name:</b>	<b>Model Numbers:</b>
<b>Job Number:</b>	

## Specifications

### Regulatory Approvals

- UL® Listed to U.S. and Canadian safety requirements.
- NOM Certification (MS- models only).

### Power

- 120 V~ 50/60 Hz<sup>1</sup>
- 120–277 V~ 50/60 Hz<sup>1</sup>

### Key Design Features

- All lighting loads
- Crush/tamper resistant lens
- Smart ambient light detection
- Adaptive switching algorithm for extended relay life
- XCT Technology for fine motion detection
- Lutron patented Softswitch

### Environment

- Ambient operating temperature: 32 °F to 104 °F (0 °C to 40 °C), 0%–90% humidity, non-condensing. Indoor use only.

### Warranty

- 5-Year Limited Warranty. For additional Warranty information, please visit [www.lutron.com/TechnicalDocumentLibrary/Sensor\\_Warranty.pdf](http://www.lutron.com/TechnicalDocumentLibrary/Sensor_Warranty.pdf)

### Additional Information

- When using MS-OPS2, MS-OPS5M, MS-OPS6M2-DV, MS-VPS2, MS-VPS5M, or MS-VPS6M2-DV on GFI-controlled circuits, please see Lutron P/N 048440 on [www.lutron.com](http://www.lutron.com)
- For Maestro Occupancy sensing dimmer models, please see Lutron P/N 369270 on [www.lutron.com](http://www.lutron.com)
- For use with MA-AS, MSC-AS, MA-AS-277, or MSC-AS-277 to control the load from more than two locations, please see Lutron P/N 048435 on [www.lutron.com](http://www.lutron.com)
- For more information, please see [www.lutron.com/occvacensors](http://www.lutron.com/occvacensors)
- Lutron Customer Assistance: 1.844.LUTRON1

## Advanced Features

### Switching

- Standard zero cross—maximizes relay life by switching at the point of minimum energy on the AC power curve
- Adaptive zero cross—maximizes relay life by switching at the point of minimum energy on the AC power curve. Actively adapts to variations in relay timing
- Lutron Patented Softswitch circuit—eliminates arcing at mechanical contacts when loads are switched. Extends relay life to an average of 1,000,000 cycles (on/off) for resistive, capacitive, or inductive sources

### XCT Technology

Advanced sensing technology for fine motion detection ensures that the lights stay on while the room is occupied, and that the sensor does not turn on falsely when there is no occupancy in the room. For more information, see [www.lutron.com/TechnicalDocumentLibrary/white%20paper%20XCT%204-23-09%20B.pdf](http://www.lutron.com/TechnicalDocumentLibrary/white%20paper%20XCT%204-23-09%20B.pdf)

<sup>1</sup> Maximum current ratings for individual models are provided in the **Selection Matrix** on page 4.

<p><b>Job Name:</b></p> <p><b>Job Number:</b></p>	<p><b>Model Numbers:</b></p>
--	------------------------------

## Custom Settings

### Ambient Light Detection

Lights turn on only if natural light in room is low.

- Smart—Ambient light threshold adjusts precisely to the user’s preference.

Instructions: If switch turns on when there is enough natural light, or if switch does not turn on when there is not enough natural light, press the large button within 5 seconds of entering the room. Over time, this interaction will “teach” the switch your preferred setting.

- Presets—high, medium, low, and disabled.

### Sensor Operation

- Occupancy/Vacancy: Auto-ON / Auto-OFF or Manual-ON / Auto-OFF
- Vacancy only: Manual-ON / Auto-OFF only

### Timeout Options

(See **Additional Features** on page 5 for default settings)

- 1 Minute
- 5 Minutes
- 15 Minutes
- 30 Minutes

### Sensitivity Options

- High sensitivity (default)
- Low sensitivity

### Auto-ON Options

(MS-OPS and UMS-OPS only)

- Occupancy (default): Auto-ON / Auto-OFF
- Vacancy\*: Manual-ON / Auto-OFF
- Low Light: Lights turn on only if needed (if ambient light is below threshold)

\* There is a 15-second grace period that begins when the lights are automatically turned off, during which the lights will automatically turn back on in response to motion. This grace period is provided as a safety and convenience feature in the event that the lights turn off while the room is still occupied, so that the user does not need to manually turn the lights back on. After 15 seconds, the grace period expires and the lights must be manually turned on.

### Manual Off-While-Occupied Options

(MS-OPS and UMS-OPS only — see **Additional Features** on page 5 for default setting)

- Enabled
  - When the Occupancy sensing switch is manually turned off, the Occupancy sensing switch will not turn the lights back on automatically while the room is occupied.
  - Once the room is vacated, the Auto-ON feature returns to normal operation after the timeout period has expired.
  - This may be the preference in conference rooms or classrooms while viewing presentations. This feature requires motion to keep the lights off.
- Disabled
  - When the Occupancy sensing switch is manually turned off, the Auto-ON feature will return to normal operation after 25 seconds.
  - This may be the preference if the user always wants the lights to turn on upon entering and the lights to turn off when the room is vacant.

Job Name:	Model Numbers:
Job Number:	

### Selection Matrix

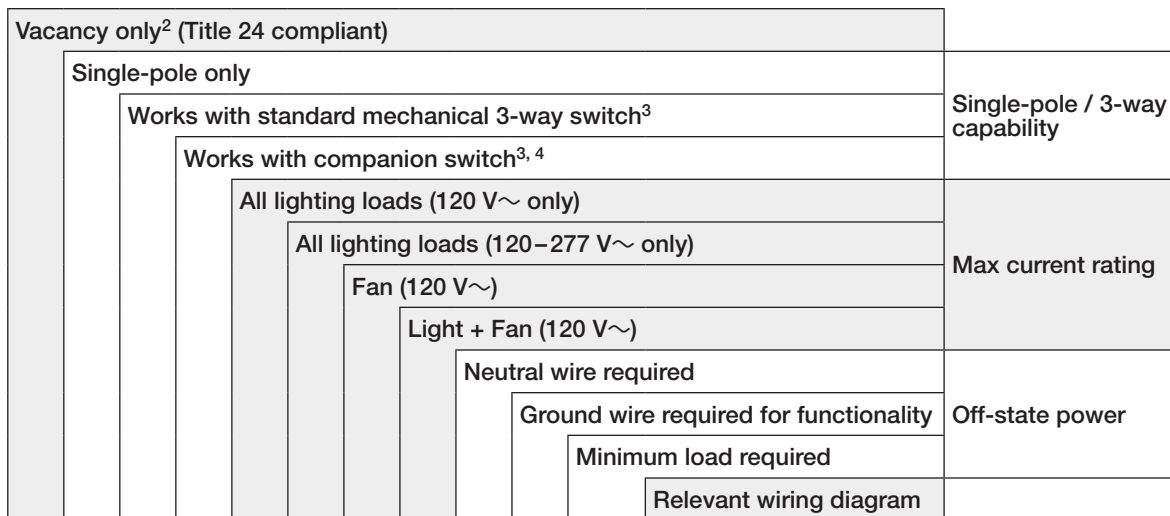

**Model Number<sup>1</sup>**

MS-OPS2-XX		✓			2 A					✓		1
MS-OPS2H-XX-C		✓			2 A					✓		1
MS-OPS5M-XX			✓	✓	5 A		3 A	3 A		✓		2, 3, 5
MS-OPS5MH-XX-C			✓	✓	5 A		3 A	3 A		✓		2, 3, 5
MS-OPS6M2-DV-XX			✓	✓		6 A	3 A	3 A		✓		2–6
MS-OPS6M2N-DV-XX			✓	✓		6 A	3 A	3 A	✓			7–11
UMS-OPS6M-DV-XX <sup>5</sup>				✓		6 A	3 A	3 A			25 W	12–17
MS-VPS2-XX	✓	✓			2 A					✓		1
MS-VPS5M-XX	✓		✓	✓	5 A		3 A	3 A		✓		2, 3, 5
MS-VPS6M2-DV-XX	✓		✓	✓		6 A	3 A	3 A		✓		2–6
MS-VPS6M2N-DV-XX	✓		✓	✓		6 A	3 A	3 A	✓			7–11
UMS-VPS6M-DV-XX <sup>5</sup>	✓			✓		6 A	3 A	3 A			25 W	12–17

- <sup>1</sup> XX in model number represents color/finish code.
- <sup>2</sup> Occupancy sensors can be configured as Auto-ON / Auto-OFF or Manual-ON / Auto-OFF. Vacancy sensors are configured as Manual-ON / Auto-OFF only.
- <sup>3</sup> Standard mechanical 3-way switch cannot be combined with companion switch.
- <sup>4</sup> Companion switch MA-AS, MSC-AS, MA-AS-277, or MSC-AS-277 is required for multi-location installations (more than two locations controlling the same lighting circuit). Up to nine companion switches may be connected.
- <sup>5</sup> BAA-compliant models.

<p>Job Name:</p>  <p>Job Number:</p>	<p>Model Numbers:</p>
--	-----------------------

## Additional Features

Crush/tamper-resistant lens						
Ambient light detection						
Switching						
XCT technology						
Manual off-while-occupied default setting						
Default timeout (minutes)						
Model Number <sup>1</sup>						
MS-OPS2-XX		Smart	Standard	✓	Disabled	5
MS-OPS2H-XX-C		Smart	Standard	✓	Disabled	5
MS-OPS5M-XX		Smart	Standard	✓	Disabled	5
MS-OPS5MH-XX-C		Smart	Standard	✓	Disabled	5
MS-OPS6M2-DV-XX	✓	Smart	Adaptive	✓	Enabled	15
MS-OPS6M2N-DV-XX	✓	Smart	Adaptive	✓	Enabled	15
UMS-OPS6M-DV-XX		Presets	Softswitch	✓	Enabled	5
MS-VPS2-XX		Smart	Standard	✓		5
MS-VPS5M-XX		Smart	Standard	✓		5
MS-VPS6M2-DV-XX	✓	Smart	Adaptive	✓		15
MS-VPS6M2N-DV-XX	✓	Smart	Adaptive	✓		15
UMS-VPS6M-DV-XX		Presets	Softswitch	✓		5

<sup>1</sup> XX in model number represents color/finish code.

Job Name:	Model Numbers:
Job Number:	

### Occupancy Sensing Switch Placement and Operation



- The ability of the Occupancy sensing switch to detect motion requires line-of-sight of room occupants. The Occupancy sensing switch must have an unobstructed view of the room.
- Hot objects and moving air currents can affect the performance of the Occupancy sensing switch.
- The performance of the Occupancy sensing switch depends on a temperature differential between the ambient room temperature and that of room occupants. Warmer rooms may reduce the ability of the Occupancy sensing switch to detect occupants.

#### Definitions

**Major motion:** movement of a person entering or passing through an area.

**Minor motion:** movement of a person occupying an area and engaging in small activities (e.g., reaching for a telephone, turning the pages of a book, opening a file folder, picking up a coffee cup).

#### NEMA WD7 Coverage

-  Major motion coverage: 900 ft<sup>2</sup> (81 m<sup>2</sup>)
-  Minor motion coverage: 400 ft<sup>2</sup> (36 m<sup>2</sup>)

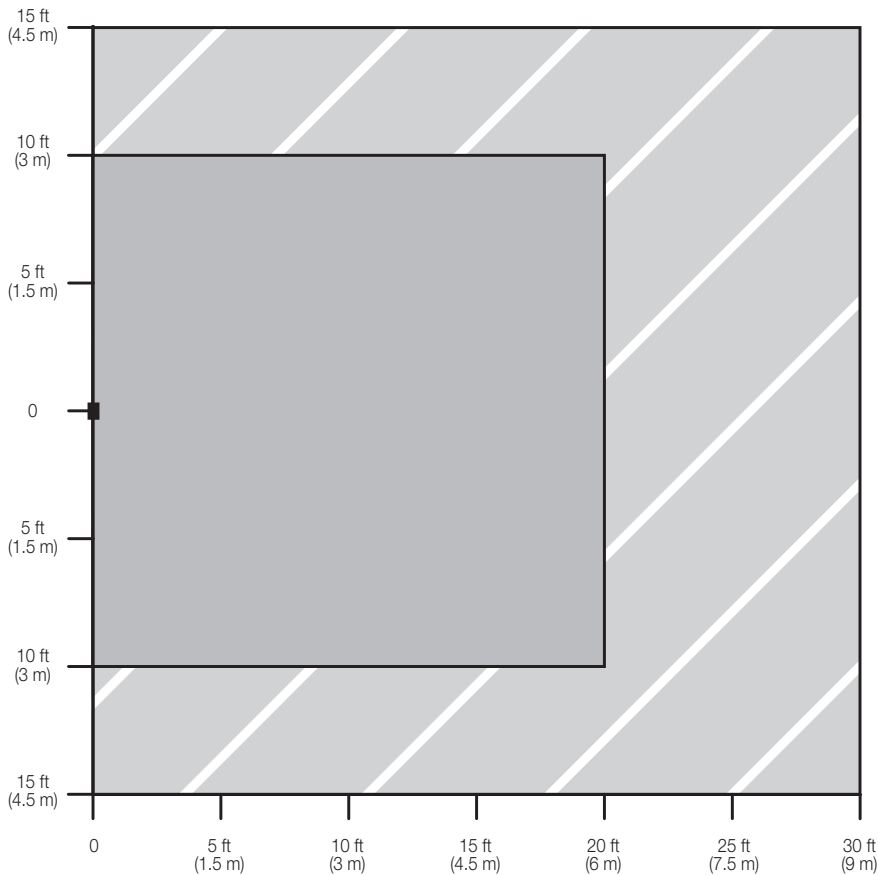

#### Horizontal Beam Diagram

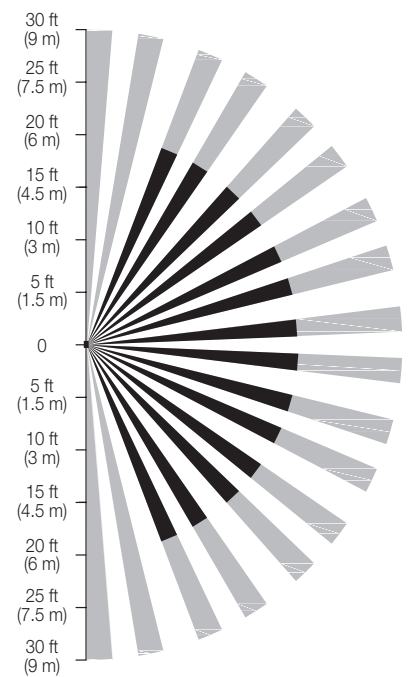

#### Vertical Beam Diagram

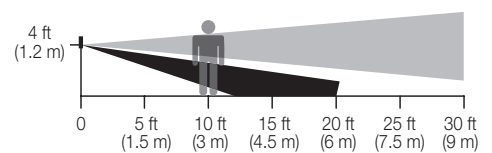

<b>Job Name:</b>	<b>Model Numbers:</b>
<b>Job Number:</b>	

### Dimensions

Measurements shown as: in (mm).

Front View

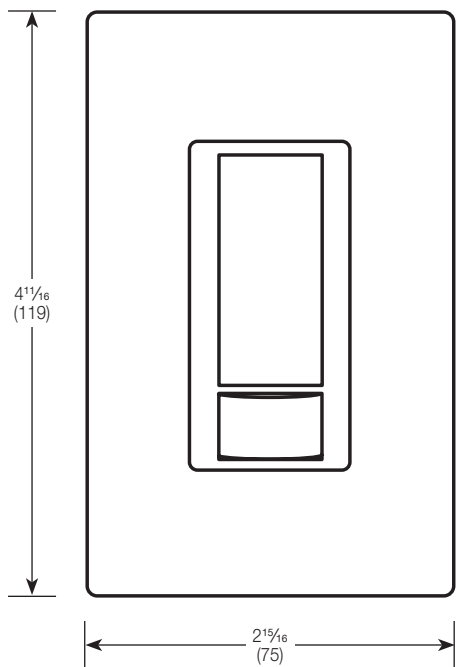

Side View



### Ganging

When ganging with other controls in the same wallbox, remove inside fins (UMS-OPS6M-DV and UMS-VPS6M-DV only).

Each control has inside fins removed



Middle of Gang control has all fins removed

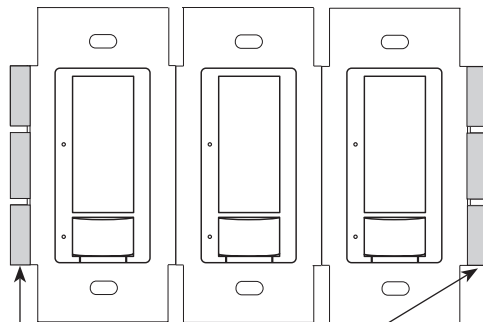

Do NOT remove outside fins on End of Gang controls

Job Name:	Model Numbers:
Job Number:	



### Mounting

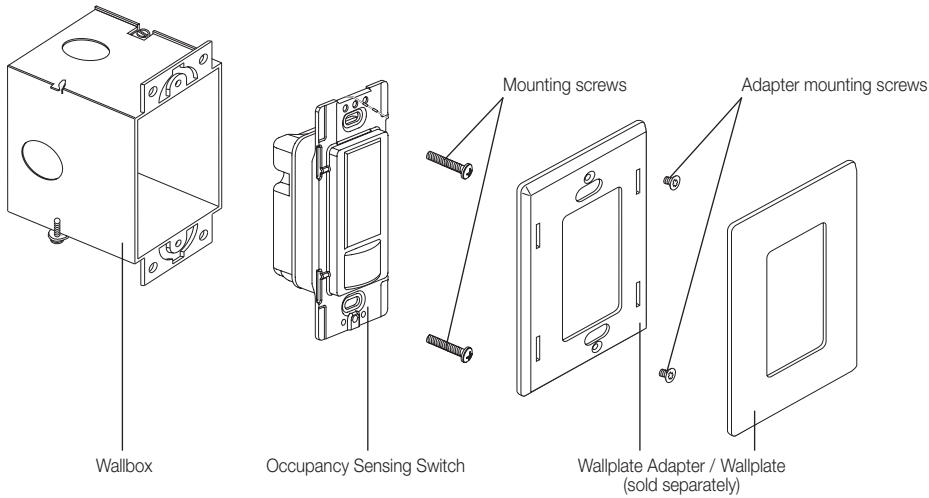

### Operation



- MS-OPS2
- MS-OPS5M
- MS-OPS6M2-DV
- MS-OPS6M2N-DV
- MS-VPS2
- MS-VPS5M
- MS-VPS6M2-DV
- MS-VPS6M2N-DV

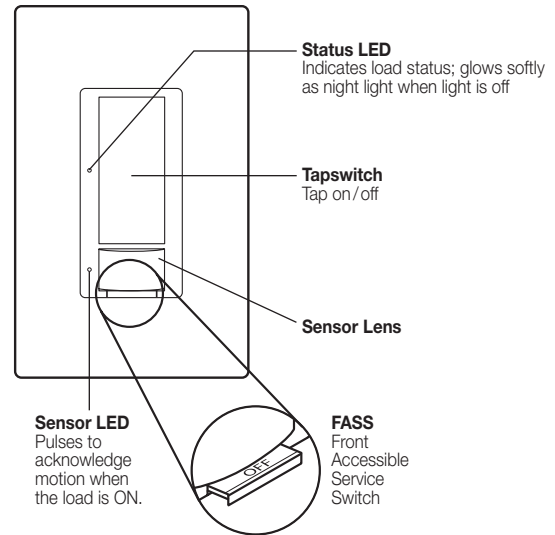

- UMS-OPS6M-DV
- UMS-VPS6M-DV

#### IMPORTANT NOTICE

**FASS – Front Accessible Service Switch** – To service load, remove power by pulling the FASS switch out completely on either the Dimmer or Companion Dimmer. After servicing load, push the FASS switch back in fully to restore power to the control.

Job Name:	Model Numbers:
Job Number:	

## Wiring Diagrams

### Wiring Diagram 1

#### Single Location Installation (120 V~)

-OPS2 and -VPS2

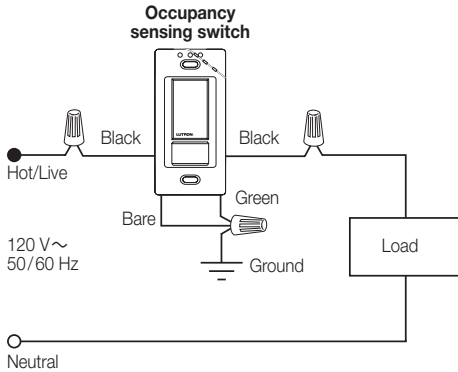

### Wiring Diagram 2

#### Single Location Installation (120 V~)<sup>1</sup>

-OPS5M, -OPS6M2-DV, -VPS5M, -VPS6M2-DV

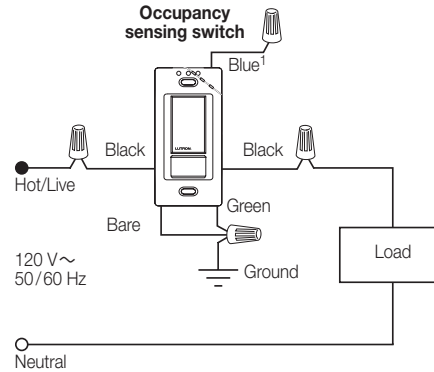

### Wiring Diagram 3

#### 3-way Installation with Standard Mechanical Switch (120 V~)<sup>2, 3</sup>

-OPS5M, -OPS6M2-DV, -VPS5M, -VPS6M2-DV

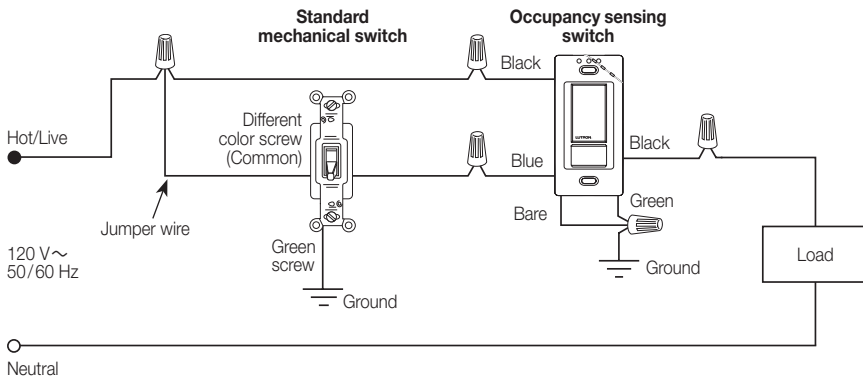

OR

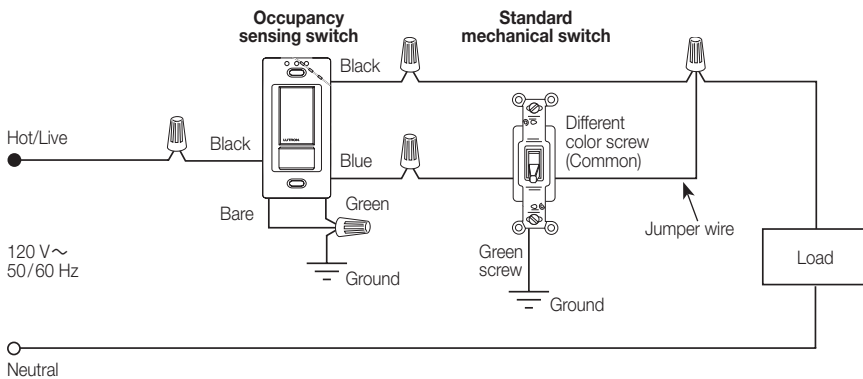

<sup>1</sup> When using controls in single location installations, tighten the blue terminal or cap blue wire. Do not connect the blue terminal/wire to any other wire or to ground.

<sup>2</sup> Only one Occupancy sensing switch can be used per multi-location circuit.

<sup>3</sup> A single standard mechanical 3-way switch or up to 9 companion switches may be connected to most Occupancy sensing switches. Standard mechanical 3-way switch cannot be combined with companion switch. Total blue terminal wire length may be up to 150 ft (46 m).

Continued on next page...

Job Name:	Model Numbers:
Job Number:	

### Wiring Diagrams (continued)

#### Wiring Diagram 4

3-way Installation with Standard Mechanical Switch (277 V~)<sup>1, 2, 3</sup>  
-OPS6M2-DV, -VPS6M2-DV

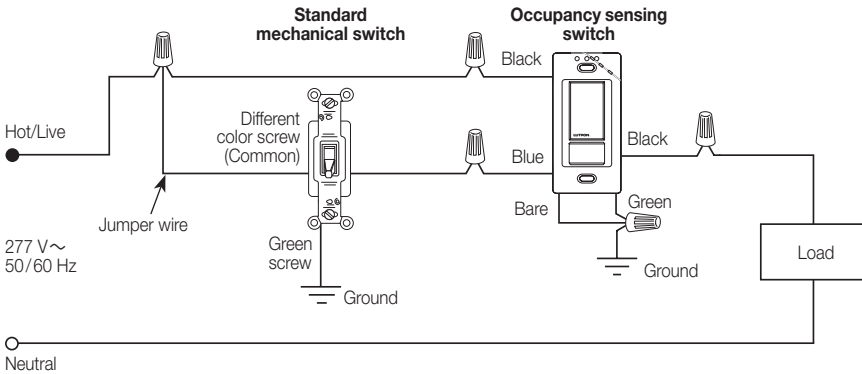

OR

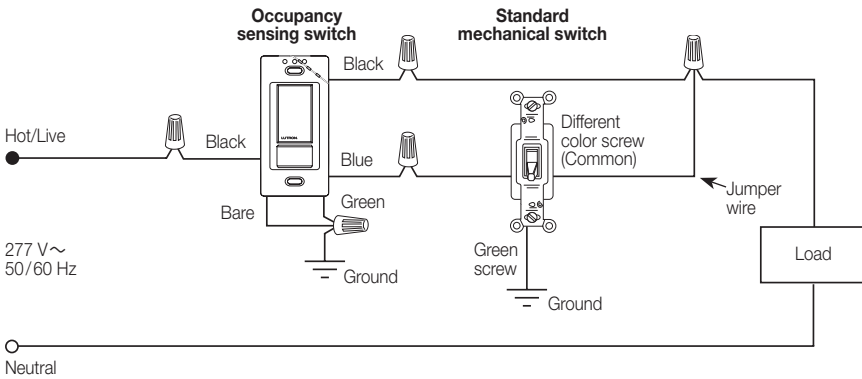

#### Wiring Diagram 5

Multi-Location Installation (120 V~)<sup>1, 2, 4</sup>  
-OPS5M, -OPS6M2-DV, -VPS5M, -VPS6M2-DV with MA-AS or MSC-AS

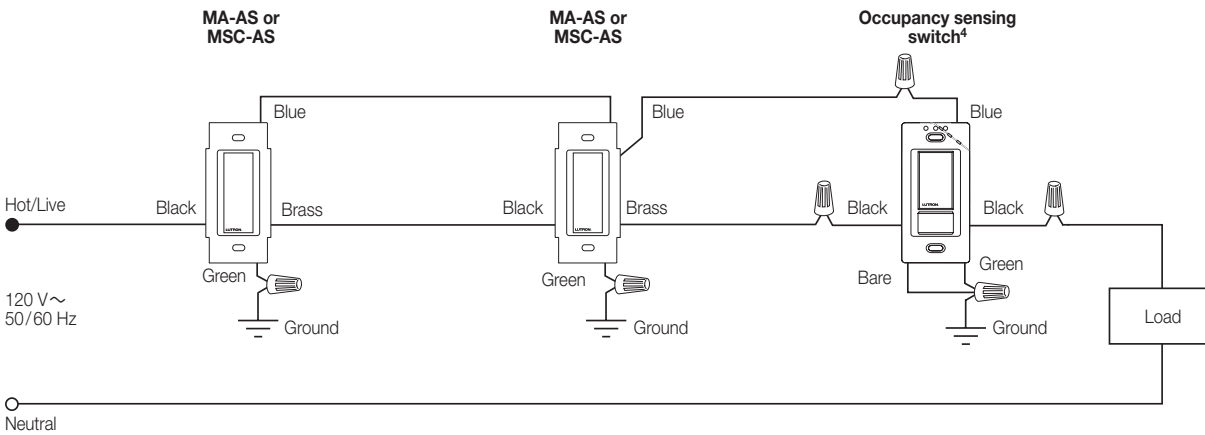

- <sup>1</sup> A single standard mechanical 3-way switch or up to 9 companion switches may be connected to most Occupancy sensing switches. Standard mechanical 3-way switch cannot be combined with companion switch. Total blue terminal wire length may be up to 150 ft (46 m).
- <sup>2</sup> Only one Occupancy sensing switch can be used per multi-location circuit.
- <sup>3</sup> Fan load applies to 120 V~ only (not for 277 V~).
- <sup>4</sup> Occupancy sensing switch can be installed in any location.

Continued on next page...

<b>Job Name:</b>	<b>Model Numbers:</b>
<b>Job Number:</b>	

### Wiring Diagrams *(continued)*

#### Wiring Diagram 6

#### Multi-Location Installation (277 V~)<sup>1, 2, 3, 4</sup>

-OPS6M2-DV, -VPS6M2-DV with MA-AS-277 or MSC-AS-277

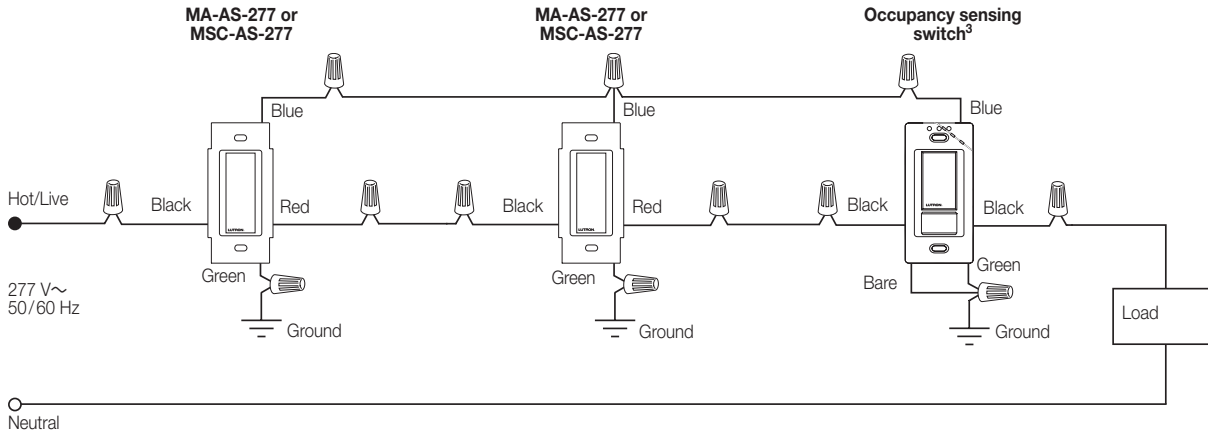

- <sup>1</sup> A single standard mechanical 3-way switch or up to 9 companion switches may be connected to most Occupancy sensing switches. Standard mechanical 3-way switch cannot be combined with companion switch. Total blue terminal wire length may be up to 150 ft (46 m).
- <sup>2</sup> Only one Occupancy sensing switch can be used per multi-location circuit.
- <sup>3</sup> Occupancy sensing switch can be installed in any location.
- <sup>4</sup> Fan load applies to 120 V~ only (not for 277 V~).

*Continued on next page...*

<b>Job Name:</b>	<b>Model Numbers:</b>
<b>Job Number:</b>	

Wiring Diagrams *(continued)*

Wiring Diagram 7

Single Location Installation (120-277 V~)<sup>1, 2</sup>

-OPS6M2N-DV, -VPS6M2N-DV

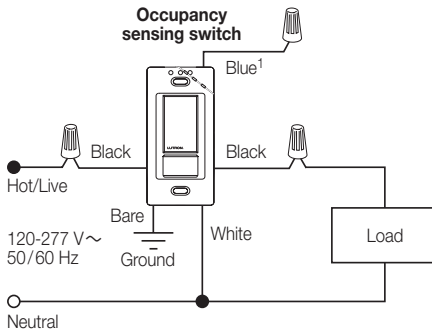

Wiring Diagram 8

3-way Installation with Standard Mechanical Switch (120 V~)<sup>3, 4</sup>

-OPS6M2N-DV, -VPS6M2N-DV

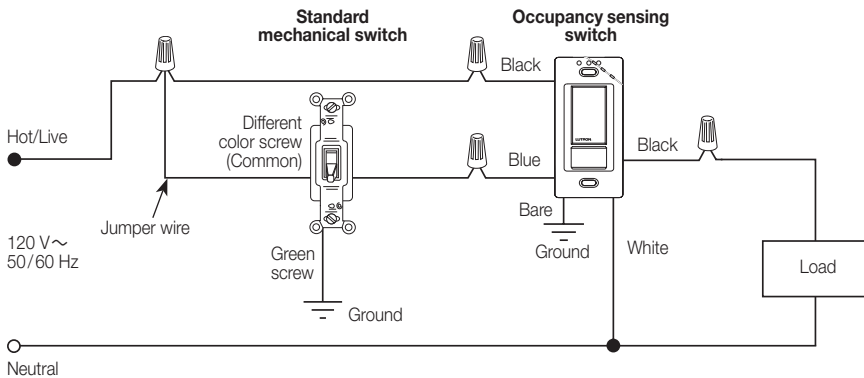

OR

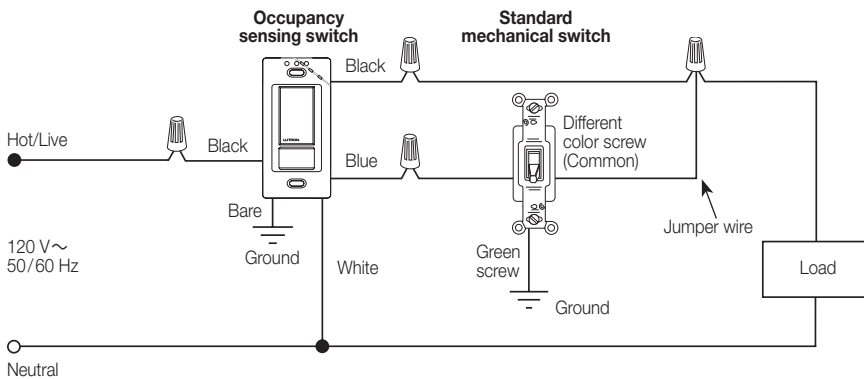

- <sup>1</sup> When using controls in single location installations, tighten the blue terminal or cap blue wire. Do **NOT** connect the blue terminal/wire to any other wire or to ground.
- <sup>2</sup> Fan load applies to 120 V~ only (not for 277 V~).
- <sup>3</sup> Only one Occupancy sensing switch can be used per multi-location circuit.
- <sup>4</sup> A single standard mechanical 3-way switch or up to 9 companion switches may be connected to most Occupancy sensing switches. Standard mechanical 3-way switch cannot be combined with companion switch. Total blue terminal wire length may be up to 150 ft (46 m).

*Continued on next page...*

<b>Job Name:</b>	<b>Model Numbers:</b>
<b>Job Number:</b>	

### Wiring Diagrams (continued)

#### Wiring Diagram 9

#### 3-way Installation with Standard Mechanical Switch (277 V~)<sup>1, 2, 3</sup>

-OPS6M2N-DV, -VPS6M2N-DV

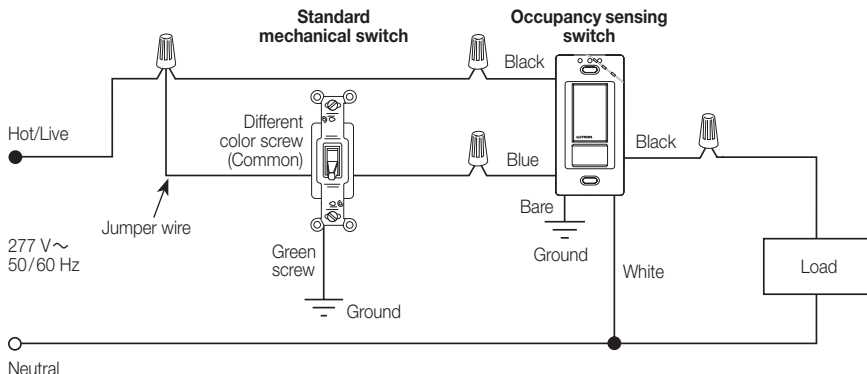

OR

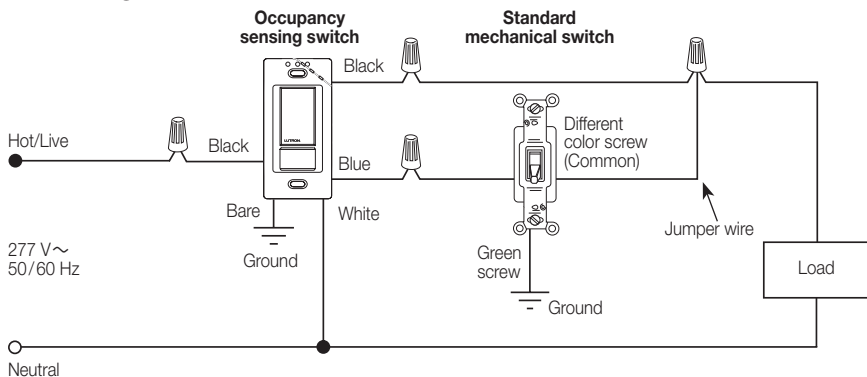

- <sup>1</sup> Only one Occupancy sensing switch can be used per multi-location circuit.
- <sup>2</sup> A single standard mechanical 3-way switch or up to 9 companion switches may be connected to most Occupancy sensing switches. Standard mechanical 3-way switch cannot be combined with companion switch. Total blue terminal wire length may be up to 150 ft (46 m).
- <sup>3</sup> Fan load applies to 120 V~ only (not for 277 V~).

Continued on next page...

Job Name:	Model Numbers:
Job Number:	

Wiring Diagrams (continued)

Wiring Diagram 10

Multi-Location Installation (120 V~)<sup>1, 2, 3</sup>  
 -OPS6M2N-DV, -VPS6M2N-DV with MA-AS or MSC-AS

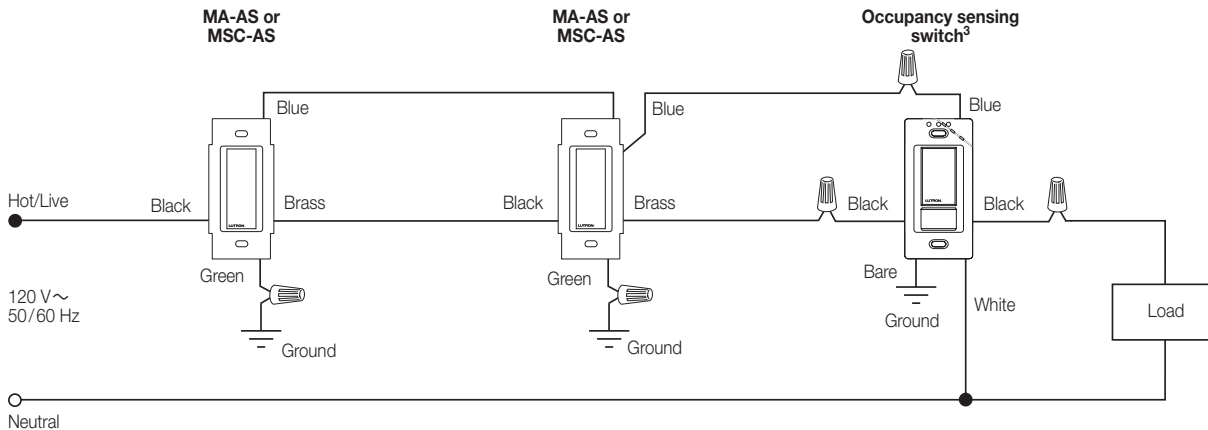

Wiring Diagram 11

Multi-Location Installation (277 V~)<sup>1, 2, 3, 4</sup>  
 -OPS6M2N-DV, -VPS6M2N-DV with MA-AS-277 or MSC-AS-277

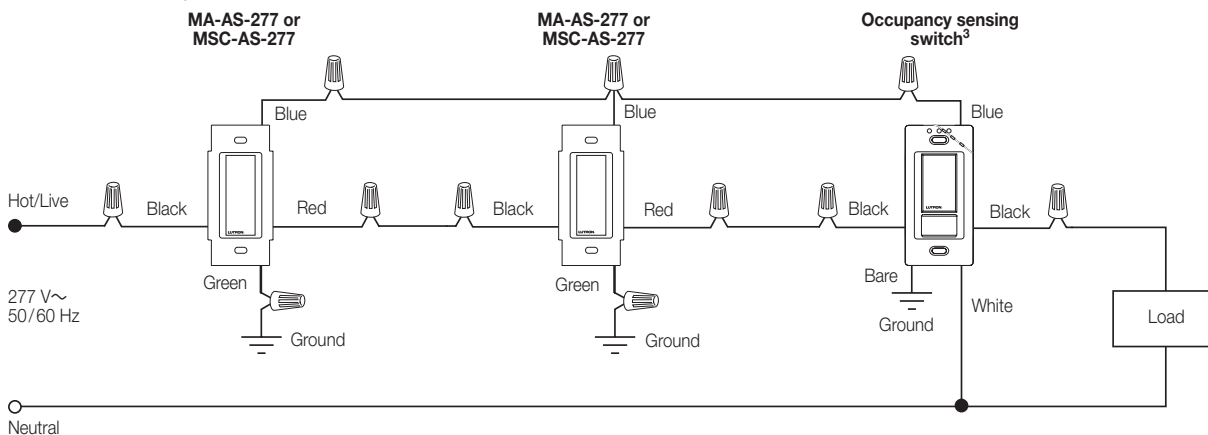

- <sup>1</sup> A single standard mechanical 3-way switch or up to 9 companion switches may be connected to most Occupancy sensing switches. Standard mechanical 3-way switch cannot be combined with companion switch. Total blue terminal wire length may be up to 150 ft (46 m).
- <sup>2</sup> Only one Occupancy sensing switch can be used per multi-location circuit.
- <sup>3</sup> Occupancy sensing switch can be installed in any location.
- <sup>4</sup> Fan load applies to 120 V~ only (not for 277 V~).

Continued on next page...

<b>Job Name:</b>	<b>Model Numbers:</b>
<b>Job Number:</b>	

### Wiring Diagrams (continued)

#### Wiring Diagram 12

Single Location Installation<sup>1, 2</sup>  
-OPS6M-DV and -VPS6M-DV

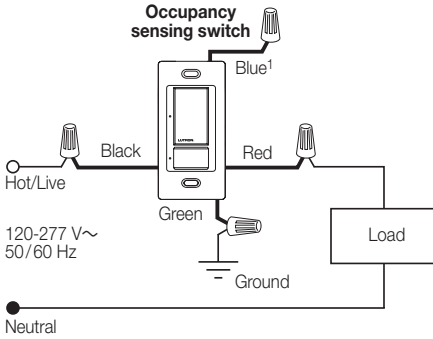

#### Wiring Diagram 13

Single Location Installation with Shunt Capacitor<sup>1, 2, 3</sup>  
-OPS6M-DV and -VPS6M-DV

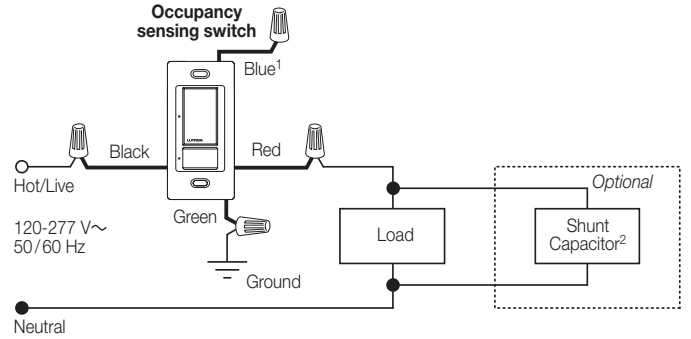

#### Wiring Diagram 14

Multi-Location Installation (120 V~)<sup>1, 4, 5, 6</sup>  
-OPS6M-DV and -VPS6M-DV with MA-AS or MSC-AS

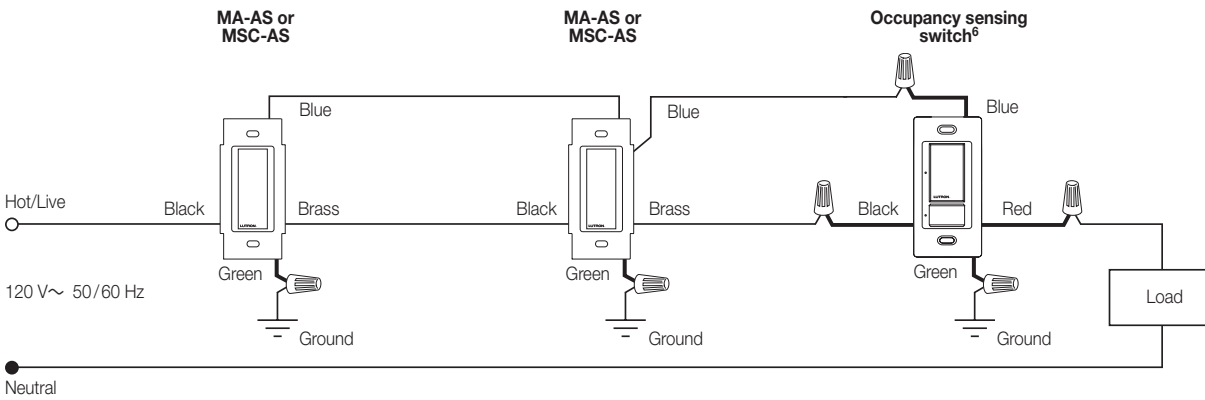

#### Wiring Diagram 15

Multi-Location Installation (277 V~)<sup>1, 2, 3, 4, 5, 6</sup>  
-OPS6M-DV and -VPS6M-DV with MA-AS-277 or MSC-AS-277

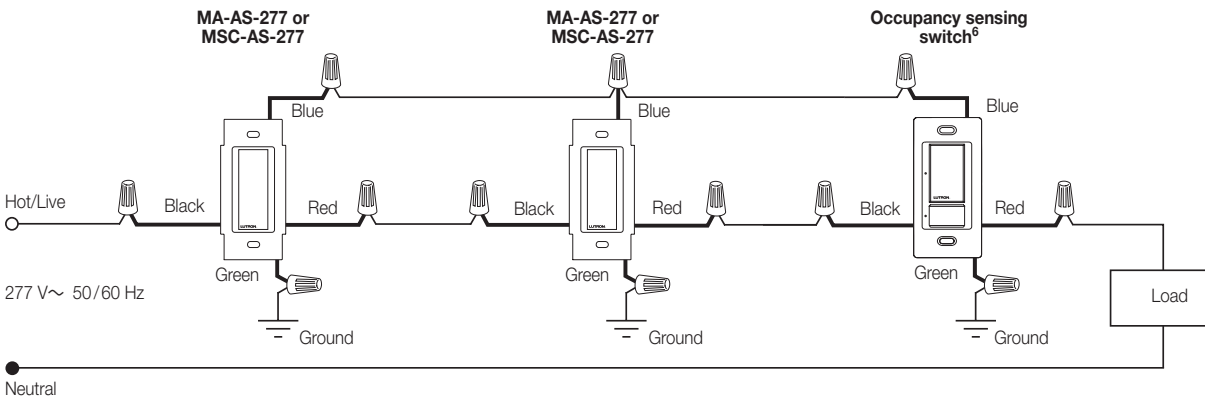

- <sup>1</sup> When using controls in single location installations, tighten the blue terminal or cap blue wire. Do not connect the blue terminal/wire to any other wire or to ground.
- <sup>2</sup> Fan load applies to 120 V~ only (not for 277 V~).
- <sup>3</sup> Optional shunt capacitor must be installed inside the load fixture or in a separate J-box.
- <sup>4</sup> Up to 9 companion switches may be connected to an Occupancy sensing switch. Total blue terminal wire length may be up to 250 ft (76 m).
- <sup>5</sup> Only one Occupancy sensing switch can be used per multi-location circuit.
- <sup>6</sup> Occupancy sensing switch can be installed in any location.

Continued on next page...

<b>Job Name:</b>	<b>Model Numbers:</b>
<b>Job Number:</b>	



Wiring Diagrams (continued)

Wiring Diagram 16

Multi-Location Installation with Shunt Capacitor (120 V~)<sup>1, 2, 3, 4</sup>

-OPS6M-DV and -VPS6M-DV with MA-AS or MSC-AS

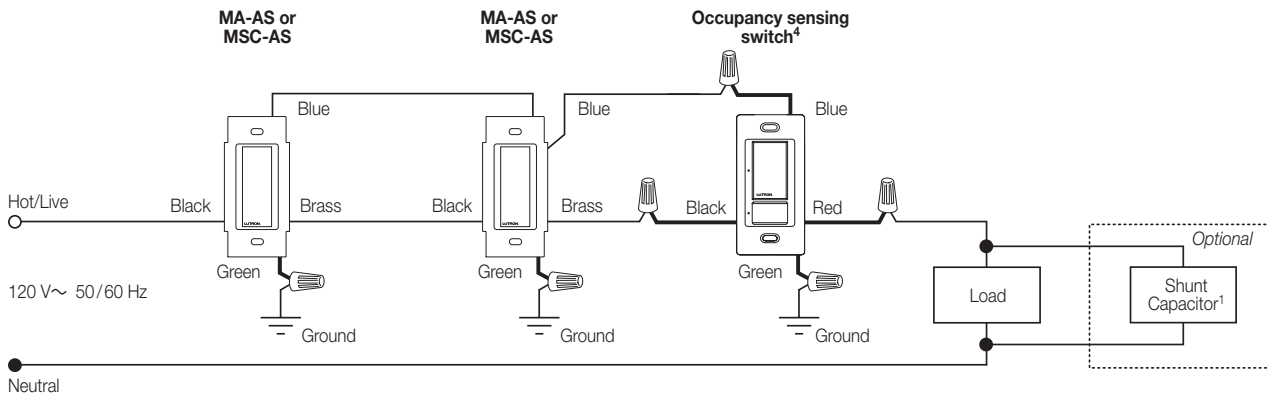

Wiring Diagram 17

Multi-Location Installation with Shunt Capacitor (277 V~)<sup>1, 2, 3, 4, 5</sup>

-OPS6M-DV and -VPS6M-DV with MA-AS-277 or MSC-AS-277

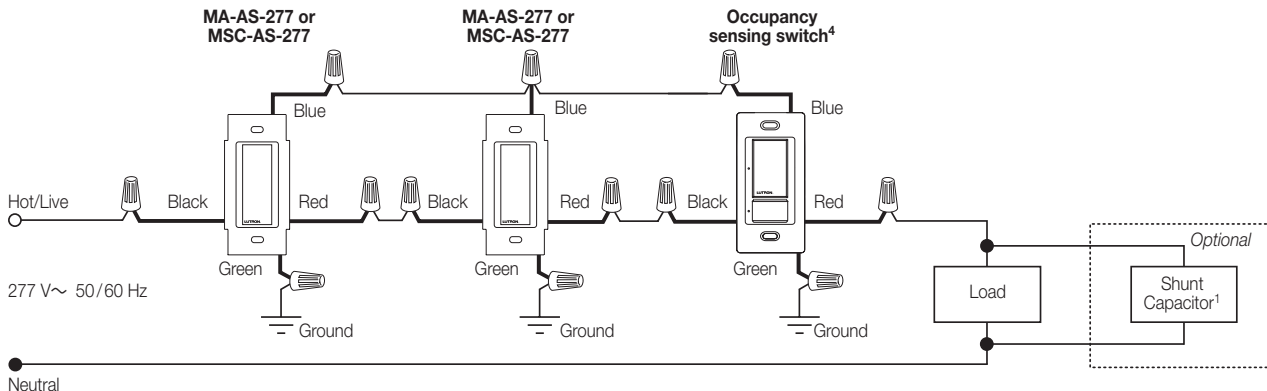

- <sup>1</sup> Optional shunt capacitor must be installed inside the load fixture or in a separate J-box.
- <sup>2</sup> Up to 9 companion switches may be connected to an Occupancy sensing switch. Total blue terminal wire length may be up to 250 ft (76 m)
- <sup>3</sup> Only one Occupancy sensing switch can be used per multi-location circuit.
- <sup>4</sup> Occupancy sensing switch can be installed in any location.
- <sup>5</sup> Fan load applies to 120 V~ only (not for 277 V~).

<b>Job Name:</b>	<b>Model Numbers:</b>
<b>Job Number:</b>	

## Colors and Finishes

### Gloss Finishes

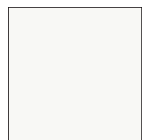

White  
WH



Ivory  
IV

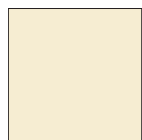

Almond  
AL



Light Almond  
LA

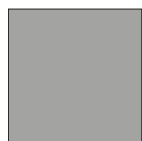

Gray  
GR



Brown  
BR



Black  
BL

### Satin Finishes



Hot  
HT



Merlot  
MR



Plum  
PL



Turquoise  
TQ



Taupe  
TP

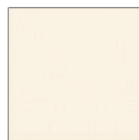

Eggshell  
ES



Biscuit  
BI



Snow  
SW



Palladium  
PD



Midnight  
MN



Sienna  
SI

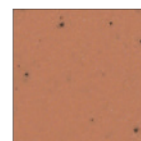

Terracotta  
TC

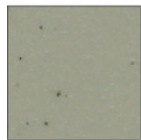

Greenbriar  
GB



Bluestone  
BG

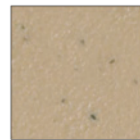

Mocha Stone  
MS

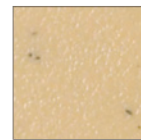

Goldstone  
GS



Desert Stone  
DS

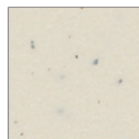

Stone  
ST



Limestone  
LS



Sea Glass  
SG

- Due to printing limitations, colors and finishes shown cannot be guaranteed to match actual product colors perfectly.
- Color chip keychains are available for more precise color matching:  
 Gloss Finishes: DG-CK-1  
 Satin Finishes: SC-CK-1

Lutron, Lutron, Maestro, and Softswitch are trademarks of Lutron Electronics Co., Inc., registered in the U.S. and other countries.

XCT and FASS are trademarks of Lutron Electronics Co., Inc.

## LUTRON SPECIFICATION SUBMITTAL

Page

<p><b>Job Name:</b></p> <p><b>Job Number:</b></p>	<p><b>Model Numbers:</b></p>
--	------------------------------