

Terminals, Kits and Tools

3M has been a leading supplier of terminals for more than 30 years. Our satisfied customers know our products for:

- Effective and reliable performance.
- Variety of types, sizes and materials that meet a broad application range, including the demands of temperature and weather.
- Design features assuring easy installation of 3M™ Products—positive and easy wire insertion, elimination of strand hang-ups and wire twisting, and easy insulation entry. These are a few of the characteristics that make the installer's job easier.

Customers can choose from two terminal families to meet their needs.

3M™ Scotchlok™ Terminals

Our premier line of terminals allow for various insulation types (such as heat shrink, nylon, vinyl, or non-insulated). Various barrel styles are available (such as butted, brazed, seamless, or interlocking barrel). Additionally, our premier terminals come in bottle or bulk packaging.

3M™ Highland™ Terminals

These terminals are either vinyl or nylon insulated with a butted seam. They come packaged in small quantities in reclosable plastic bags.

3M Terminals help accommodate the installer's needs.



Glossary of Terminals and Tools Terms

ADAPTERS

To interconnect two connectors already attached to wires.

BLOCK FORK

Same strength as the fork, but designed to use in terminal block because sides lie flat against barrier portion of terminal block.

BULLET STYLE SNAP PLUG

Similar advantages as disconnects. Gives reliable in-line connection because parts are made to have holding friction when joined. Usually for automotive use.

BUTT

Uses chamfered barrel ends to provide fast, easy wire insertion from both ends and a built-in wire stop for correct positioning. Must be crimped at both ends.

CLOSED-END

Used in situations requiring pigtail of two or more wires.

FLANGED FORK

Gives the benefit of both the block and locking forks. Stays secure should screw loosen.

FORK

Allows rapid connection of wire. Usually used on free-standing studs, because of wider tongues.

LOCKING FORK

The spring-like tongue locks in place around the stud even when mount screw is not tightened. Extra force is required to remove from stud.

PARALLEL

Similar to butt with overlapped wires and single crimp in center of connector. Used where space is limited.

PINS

For installation in compression blocks. Used in Europe for terminating stranded wire.

QUICK CONNECT (DISCONNECT)

Attached to mating part by tongue of female part slipping over male tab. Use of dents and rolled edges on female part provides excellent holding force while allowing easy and quick disconnect.

RING

The standard style of tongue. The safest and most reliable 3M terminal. It cannot be removed unless mounting screw is removed.

TAB

Uses mounting hole for rivet or screw.

TAP

No wire stripping is necessary, just lay wire in connector and crimp. Connection is made.

Standard Terminal Construction

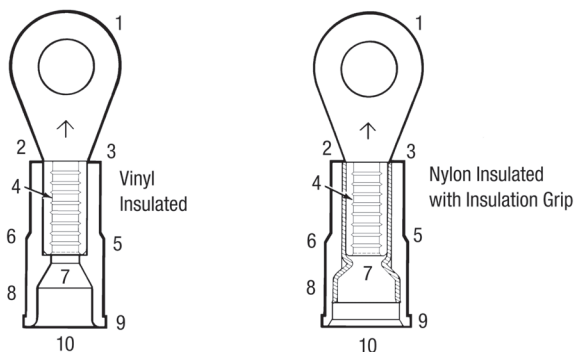

3M™ Terminals provide a variety of design features assuring consistently effective, reliable performance and easy installation.

Please refer to the illustrations at the numbered locations for the attributes described below.

1. One-piece, burr-free construction provides maximum electrical conductivity. Electrical bright-tin plating gives maximum corrosion resistance. Annealing relieves stress points and provides maximum installed strength.
2. Barrel-to-pad transition design minimizes flexing and bending.
3. Open-end design permits visual inspection of wire location before and after crimping.
4. Maximum hold on wire comes from multiple “V” grooves in #22–4 AWG parts resulting in excellent holding power.
5. Injection molded insulations on terminals are the highest quality in the industry.
 - 221°F (105°C)* rated, tough, resistant electrical grade materials
 - Molding ensures consistent wall thickness for maximum reliability after crimping
 - Molding allows funnel barrel construction for easier installation
 - Molding offers the crimp ridge and non-slip ridge
6. Crimp ridge designed for positive location of tool on terminal barrel, resulting in few miscrimps.
7. Funnel barrel construction provides:
 - Positive, easy wire insertion
 - Virtually no hang-ups of wire strands
 - Wire twisting not necessary

*Products made in U.S.A. only.

8. Nylon-insulated terminals with grip feature a brass sleeve. Sleeve provides optimum grip on insulation, strain relief and vibration protection. Brass sleeve is recessed which provides excellent flash-over protection.

9. Non-slip ridge so tool slides to correct position for a proper crimp and better workmanship.

10. Beveled leading edge for easy wire insulation entry.

Barrel Styles

Non-Insulated Butted Seam

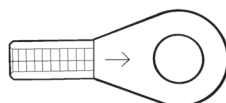

The most economical 3M terminal—used where special performance or installation characteristics are not needed. Beveled mouth facilitates wire insertion. Maximum temperature for bare terminals: 347°F (175°C).

Non-Insulated Brazed Seam

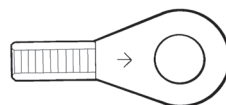

Beveled mouth facilitates wire insertion. Can be crimped anywhere on barrel surface. Silver brazed seam will not open under crimping pressure or operating stresses. Unlike butted seam parts, stranded wire cannot escape barrel confines during or after crimping. Maximum temperature for bare terminals: 347°F (175°C).

Vinyl Insulated Brazed and Butted Seams

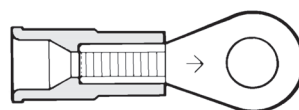

Used where insulated barrel is necessary and desirable. Terminal consists of brazed or butted part with flared, rigid molded polyvinyl chloride sleeve securely attached and funneled for easy wire entry. Wire insulation positions itself against funnel portion of vinyl sleeve thus virtually eliminating strand hang-up. Crimping barrel and flared portion of sleeve provide excellent electrical contact plus mechanical stress relief at junction of insulation and barrel. Insulation has a non-slip ridge for ease of positioning crimping tool.

Nylon Insulated Butted Seam with Insulation Grip

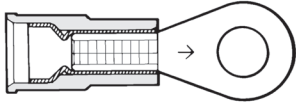

Used where insulated barrel and positive insulation grip are necessary or desirable. Terminal consists of butted seam part with flared, seamless brass sleeve securely attached and covered with flared, molded nylon sleeve. Wire insulation positions itself against funnel portion of brass sleeve. Crimping barrel and flared portion of sleeve provide excellent electrical contact plus mechanical stress relief at junction of insulation and barrel. Positioning crimp tool is nearly mistake proof due to a “step” in nylon insulation. Industry standard color coding indicates wire range. Insulators are rated at a continuous operating temperature range from -40°F to 221°F (-40°C to 105°C)*.

UL Listed and CSA Certified for 600V building wire and 1000V signs and lighting fixtures (luminaries)*.

Installation Procedure

Funnel Barrel Feature provides an excellent electrical and mechanical connection.

- Funnel design guides wire into position.

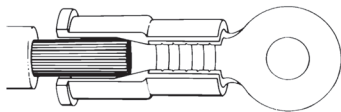

- No wire strand hang-up as the wire is inserted, giving a fast, positive installation.

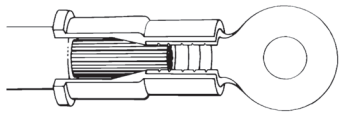

- Wire is in place, ready for crimping.

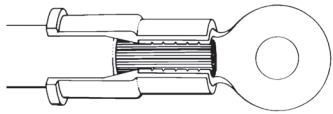

For maximum crimping performance, barrel of connector must be properly indexed in the crimp tool station.

*Products made in U.S.A. only.

Correct crimping is important to assure a strong connection.

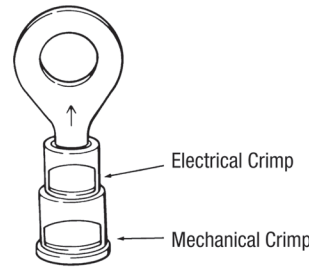

Insulated Terminals and Connectors:



Non-Insulated Terminals and Connectors:

Indent should be opposite the barrel seam.

Heat Shrink Terminals, Connectors and Disconnects

3M™ Heat Shrink Pre-insulated Terminals, Connectors and Disconnects protect against the most challenging of environments, making the best moisture protection available. They offer several advantages over conventional unsealed products.

Corrosion Resistance

The adhesive-lined heat shrink material, when properly crimped and shrunk, provides a seal resistant to water, salt, steam and other related contaminants.

Improved Mechanical Performance

The adhesive-lined heat shrink tubing adheres, when shrunk, to both the connector and the wire insulation providing improved pullout strength and strain relief.

Durable Heat Shrink Tubing

Tough heat shrink tubing effectively resists abrasion, scoring, cut-through, and the effects of long-term aging.

Versatile and Easy to Use

3M heat shrink terminals, splices and disconnects are available in wire sizes 22–10 AWG and can be installed easily with a recommended tool and heat source. The connectors are color-coded for wire range identification and the transparent tubing allows for visual inspection.

Application Procedure for Heat Shrink Products:

1. Strip wires to appropriate length as indicated on package label.



2. Insert wire into terminal and crimp with correct station of a recommended tool.



3. Apply heat with a recommended heat source.



High Temperature Terminals and Connectors

3M™ High Temperature Terminals and Connectors are constructed of steel with a nickel plating. Their temperature rating for continuous use at 900°F (482°C) makes them ideal for use in ovens, motors, light fixtures and other applications where other connectors could corrode or melt.

There is no applicable UL or CSA standard for high temperature steel parts.

Standard Crimp Terminal and Connector Specifications

Materials

Crimp terminals and connectors are to be burr-free, annealed and bright-tin plated ETP copper. Barrels shall be 0.25" long with brazed seams where specified. Insulation grip sleeves are to be tin-plated brass and attached securely to the barrel. Terminal insulators are to be molded polyvinyl chloride or nylon, UL Listed and CSA Certified for 600V in building wire and 1000V in signs and lighting fixtures (luminaries)*. Connector insulators are to be extruded polyvinyl chloride or nylon with a temperature rating of 221°F (105°C)*.

Construction

Most insulated terminals are to have funnel entry construction* to prevent strand hang-up and a crimp ridge for proper tool location. Nylon insulated terminals and connectors are to have butted seam barrels with insulation grip sleeves. Terminal barrels are to have multiple "V" grooves for maximum conductor retention.

*Products made in U.S.A. only.

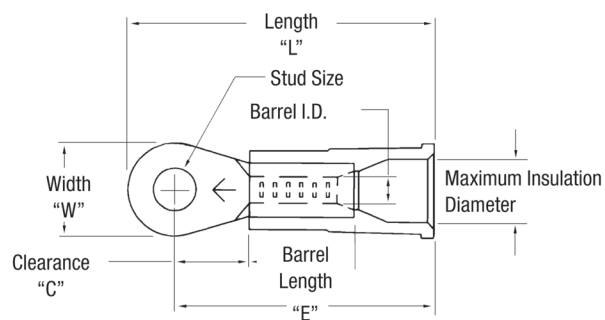

Note: All dimensions are measured in inches.

FREQUENTLY ASKED QUESTIONS

What does the insulation grip do?

The insulation grip provides a "second" crimp on the wire insulation providing additional wire strain relief. It's excellent for high vibration applications.

What's the difference between insulated and fully insulated disconnects?

Insulated disconnects have barrel insulation only and fully insulated disconnects are insulated from the barrel to the receptacle/tab.

What temperatures do 3M terminals withstand?

Non-insulated 3M terminals withstand temperatures up to 347°F (175°C). Insulated 3M terminals withstand temperatures up to 221°F (105°C).

3M™ Terminal Numbering System

3M Identity	Code/Barrel Style	Wire Size Code (AWG)	–	Stud, Tab, or Bullet Size	Tongue Code	Product Availability**
M	No Code = Bare Brazed	24 = 26–24 (yellow)	–	(STUD)	F = Fork	All bottle (X) or bag (Q) package terminals in this catalog are available (in the packaging quantity indicated) from local distributor stocks. All bulk (K) packaged terminals are available in full cartons only, and may require a three to five week order lead time from the factory.
	A = No Barrel (adapter)	20 = 26–20 (yellow)		0 = 0	FB = Fork, Block	
	I = Double Wall w/interlock	18 = 22–18 (red)		2 = 2	FBHT = Fork, Block, High Temp.	
	N = Nylon Brazed	14 = 16–14 (blue)		4 = 4	FFB = Fork, Flanged, Block	
	NG = Nylon w/ Grip	10 = 12–10 (yellow)		6 = 6	FHT = Fork, High Temp.	
	NHU = Nylon/Butted	8 = 8 (red)		8 = 8	FL = Fork, Locking	
	w/ Heat Shrink Over Top	6 = 6 (blue)		10 = 10	R = Ring	
	NU = Nylon/Butted	4 = 4 (yellow)		12 = 1/2"	RHD = Ring, Heavy Duty	
	U = Bare/Butted			14 = 1/4"	RHT = Ring, High Temp.	
	V = Vinyl/Brazed			38 = 3/8"	/S = Short or Small	
	VA = Vinyl Adapter			516 = 5/16"	/L = Large or Long	
	VU = Vinyl/Butted			610 = 6, 8, 10	R/Flag = Ring, Flag	
					BC = Butt Connector	
					CEC = Closed End Connector	
					P = Pin Connector	
					PC = Parallel Connector	
					BCM = Butt Connector	
					Moisture Res.	
					CEC/ST = Closed End Connector	
					Disconnect	
					DF = Female	
					DFHT = Female, High Temp.	
					DFI = Female, Fully Insulated	
					DM = Male	
			DMF = Male, Female			
			DMHT = Male, High Temp.			
			DMI = Male, Fully Insulated			
			DF/Flag = Female Flag Adapter			
			D = Disconnects			
			F = Female			
			FFI = Double Female, Fully Insulated			
			M = Male			
			MMI = Double Male, Fully Insulated			
			MMF = Double Male, Female			
			MFM = Male, Female, Male, Stacking			
			RR = Ring Rectangular Tongue			
			Fuse = Fuse Adapter Clip			

* A dash (–) separates the wire size code from the stud, tab or bullet size code.

** Denotes product packaging. Packaging of 3M Scotchlok™ terminals should be specified by using the appropriate terminal part number. Suffix letters are indicated within each product number. (See "Product Number" heading in ordering information charts.)

Product numbers ending with "-A" are made in Taiwan.

Note: Contact your local distributor or 3M sales office for price and delivery information.

Map of Numbering System

Example:

Catalog Number: MNG18-4 FB/SK

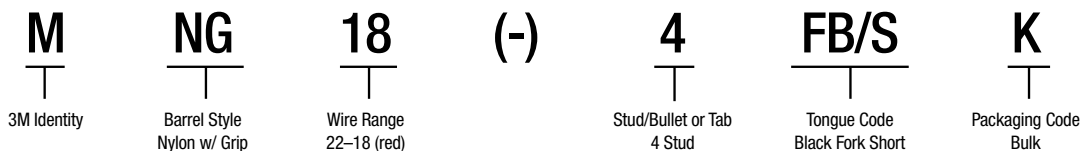



























Insulator Color Coding

Yellow (26-24 AWG) Red (22-18 AWG) Blue (16-14 AWG) Yellow (12-10 AWG) Red (8 AWG) Blue (6 AWG) Yellow (4 AWG)

*Product number ending in X = bottle; product number ending with K = bulk; product number ending with Q = bag

3M™ Terminal Stud Size Chart

	Stud Size				3M Terminal Hole Diameter
	US/Inches	Diameter		OUS/Metric	
#2		0.086" (2,144 mm)	M2		2,0 mm (0.080")
#4		0.112" (2,844 mm)	M2,5		2,5 mm (0.100")
#5		0.125" (3,175 mm)	M3		3,0 mm (0.120")
#6		0.138" (3,505 mm)	M3,5		3,5 mm (0.140")
#8		0.164" (4,166 mm)	M4		4,0 mm (0.176")
#10		0.190" (4,826 mm)	M5		5,0 mm (0.20")
1/4		0.250" (6,350 mm)	M6		6,0 mm (0.24")
5/16		0.3125" (7,938 mm)	M8		8,0 mm (0.32")
3/8		0.375" (9,525 mm)	M10		10,0 mm (0.40")
7/16		0.4375" (11,113 mm)	M10		10,0 mm (0.48")
1/2		0.500" (12,700 mm)	M12		12,0 mm (0.48")
5/8		0.625" (15,875 mm)	M16		16,0 mm (0.64")
3/4		0.750" (19,050 mm)	M18		18,0 mm (0.72")

Ref: ISO 263-1973 for inch stud sizes and ISO 262-1973 for metric stud sizes.

American Wire Gauge

Size	Inches	Millimeters	Size	Inches	Millimeters	Size	Inches	Millimeters
4/0	0.4600	11,684	4	0.2043	5,189	16	0.0508	1,290
3/0	0.4096	10,040	6	0.1620	4,115	18	0.0403	1,024
2/0	0.3648	9,266	8	0.1285	3,264	20	0.0320	0,813
1/0	0.3249	8,253	10	0.1019	2,588	22	0.0253	0,643
1	0.2893	7,347	12	0.0808	2,052	24	0.0201	0,511
2	0.2576	6,543	14	0.0641	1,628	26	0.0159	0,404

Butted Seam 900°F (482°C) High Temperature Butt Connectors

Terminal Type	Butt
Terminal Style	High Temperature
Insulation Material	Non-Insulated
Barrel Style	Butted
RoHS 2011/65/EU	Yes
Manufacturing Origin	

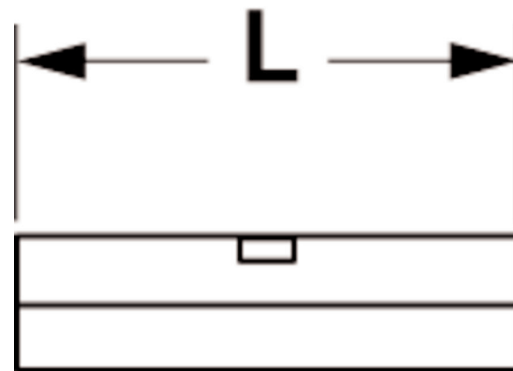

Order No.	UPC	Conductor Size	(L)	Thickness	Barrel Length	Barrel I.D.	Terminals per Carton	Terminals per Case
MU18BCHTX	051128-58957	22 - 18 AWG	0.56"	0.030"	0.25"	0.070"	100	500
MU18BCHTK	054007-01299	22 - 18 AWG	0.56"	0.030"	0.25"	0.070"	-	1000
MU14BCHTX	051128-58977	16 - 14 AWG	0.56"	0.030"	0.25"	0.090"	100	500
MU14BCHTK	054007-01761	16 - 14 AWG	0.56"	0.030"	0.25"	0.090"	-	1000
MU10BCHTX	051128-58989	12 - 10 AWG	0.56"	0.040"	0.25"	0.135"	50	500
MU10BCHTK	054007-02232	12 - 10 AWG	0.56"	0.040"	0.25"	0.135"	-	500

Butted Seam 900°F (482°C) High Temperature Female Disconnects

Terminal Type	Disconnect
Terminal Style	High Temperature
Fastener Orientation	Female
Insulation Material	Non-Insulated
Barrel Style	Butted
RoHS 2011/65/EU	Yes
Manufacturing Origin	

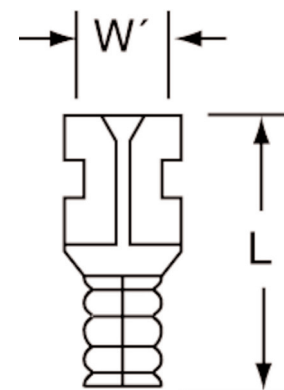

Order No.	UPC	Conductor Size	Mates with Male Tab Width (W')	(L)	Thickness	Barrel Length	Barrel I.D.	Terminals per Carton	Terminals per Case
MU14-187DFHTK	054007-01762	16 - 14 AWG	0.187"	0.58"	0.020"	0.25"	0.085"	-	1000
MU14-250DFHTK	054007-01763	16 - 14 AWG	0.250"	0.64"	0.032"	0.23"	0.095"	-	1000
MU14-250DFHTX	051128-58978	16 - 14 AWG	0.250"	0.64"	0.032"	0.23"	0.095"	100	500