

## Traditional Screwless, Mid-Size and Standard

The Traditional Style offers timeless styling for traditional décor and a wide selection of choices to meet a range of applications.

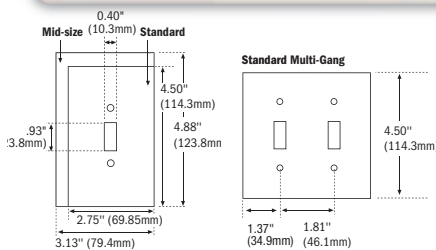

**PJS1W**



Gang	Description	Cat. No.	Color
<b>Mid-Size</b>			
1-Gang	Screwless	□ PJS1__	A, B, BK, LA, V, W
2-Gang	Screwless	□ PJS2__	A, B, BK, LA, V, W
3-Gang	Screwless	□ PJS3__	A, LA, V, W
4-Gang	Screwless	□ PJS4__	A, LA, V, W
1-Gang	Polycarbonate	□ PJ1__	A, B, BK, BL, GY, LA, RD, V, W
2-Gang	Polycarbonate	□ PJ2__	A, B, BK, BL, GY, LA, RD, V, W
3-Gang	Polycarbonate	□ PJ3__	A, B, BK, BL, GY, LA, RD, V, W
4-Gang	Polycarbonate	□ PJ4__	A, B, BK, GY, LA, V, W
5-Gang	Polycarbonate	□ PJ5__	A, B, BK, GY, LA, V, W
6-Gang	Polycarbonate	□ PJ6__	A, B, BK, GY, LA, V, W
1-Gang	Thermoset	□ 2034__	A, B, LA, V, W
2-Gang	Thermoset	□ 2039__	A, B, LA, V, W
3-Gang	Thermoset	□ 2041__	A, B, LA, V, W
4-Gang	Thermoset	□ 2054__	A, LA, V, W
1-Gang	Stainless Steel	□ 93971__	SS
2-Gang	Stainless Steel	□ 93972__	SS
3-Gang	Stainless Steel	□ 93973__	SS
<b>Standard-Size</b>			
1-Gang	Nylon	□ 5134__	A, B, BK, GY, LA, RD, V, W
2-Gang	Nylon	□ 5139__	A, B, BK, GY, LA, RD, V, W
3-Gang	Nylon	□ 5141__	A, B, BK, GY, LA, V, W
4-Gang	Nylon	□ 5154__	A, B, BK, GY, LA, V, W
1-Gang	Thermoset	□ 2134__	A, B, BK, GY, LA, V, W
2-Gang	Thermoset	□ 2139__	A, B, BK, GY, LA, V, W
3-Gang	Thermoset	□ 2141__	A, B, GY, LA, V, W
4-Gang	Thermoset	□ 2154__	A, B, LA, V, W
5-Gang	Thermoset	□ 2155__	A, B, LA, V, W
6-Gang	Thermoset	□ 2156__	A, B, LA, V, W
1-Gang	Stainless Steel	□ 93071__	SS
2-Gang	Stainless Steel	□ 93072__	SS
3-Gang	Stainless Steel	□ 93073__	SS
4-Gang	Stainless Steel	□ 93074__	SS
5-Gang	Stainless Steel	□ 93075__	SS
6-Gang	Stainless Steel	□ 93076__	SS
1-Gang	Brass	□ 94071__	Brass
2-Gang	Brass	□ 94072__	Brass
3-Gang	Brass	□ 94073__	Brass

For ordering wallplates, include Cat. No. followed by the color code: A (Almond), B (Brown), BK (Black), BL (Blue), GY (Gray), LA (Light Almond), RD (Red), RN (Orange), SS (Stainless Steel), V (Ivory), W (White)

### Thermoset

- Extensive line of non-flammable thermoset plates provides flush-fitting, warp-resistant performance
- Temperature rating: -40°C to 65°C

### Stainless Steel

- Superior non-corrosive and non-magnetic properties for applications needing protection from those elements
- Horizontally satin-brushed surface finish resists finger prints

### Solid Brass

- Strong, corrosion-resistant and coated with transparent lacquer to resist premature oxidation
- Horizontally satin-brushed surface finish resists finger prints

## Mounting Holes for Wallplates and Covers

These are the most common nominal spacings for mounting holes on wallplates and covers. Holes are normally countersunk for oval head #6-32 screws.

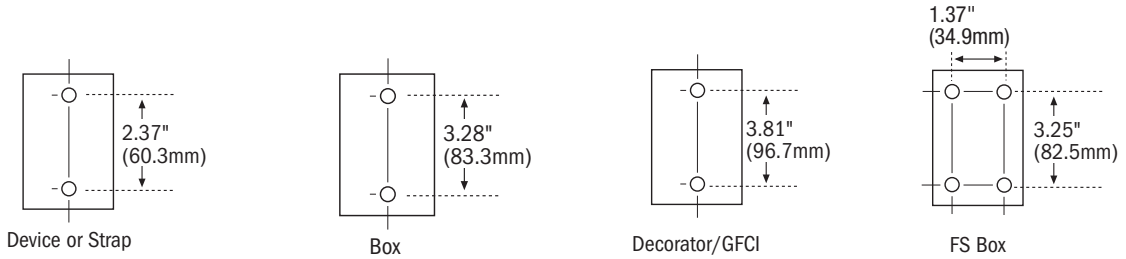

## Plate and Cover Opening Dimensions

### Cover Openings

Nominal dimensions for plate and cover openings conform to industry standards and practices.

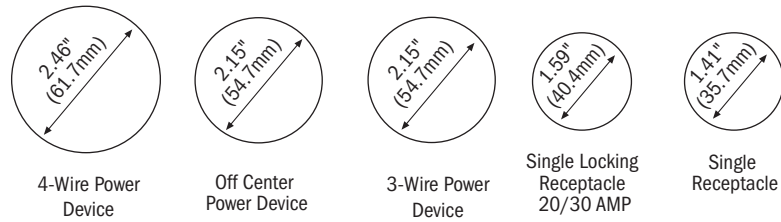

### Common Opening Configurations

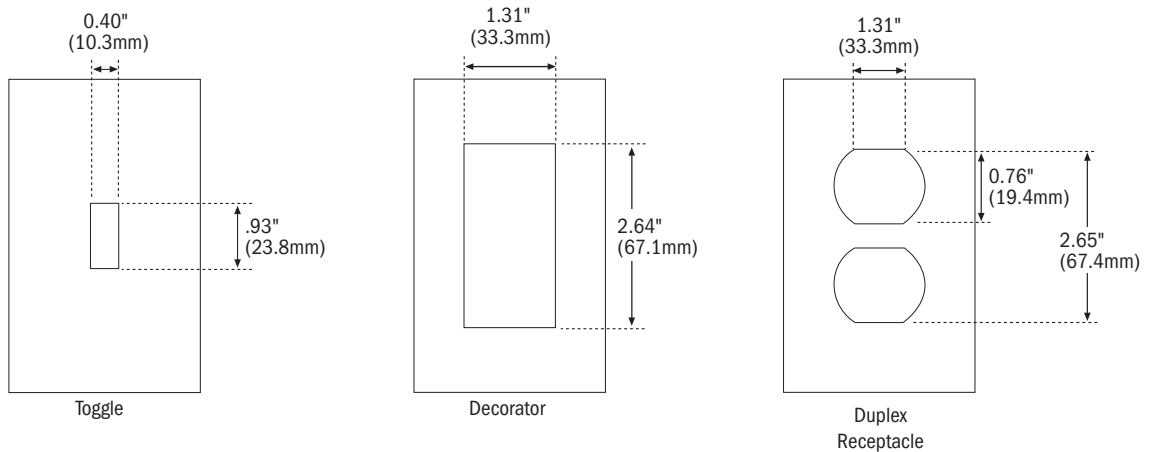

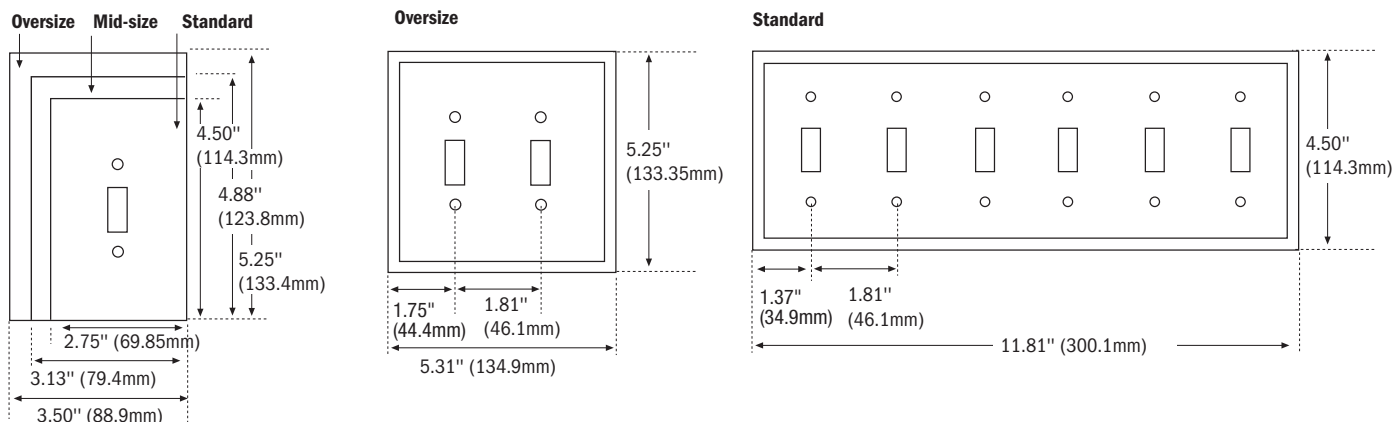

## Wallplate Sizes

Description		Height	Width	First Gang to Edge	Gang to Gang
1-Gang	Standard	4.50" (114.3mm)	2.75" (69.8mm)	1.37" (34.9mm)	—
	Mid-Size	4.87" (123.8mm)	3.12" (79.4mm)	1.56" (39.7mm)	—
	Oversize	5.25" (133.3mm)	3.50" (88.9mm)	1.75" (44.4mm)	—
2-Gang	Standard	4.50" (114.3mm)	4.56" (115.9mm)	1.37" (34.9mm)	1.81" (46.0mm)
	Mid-Size	4.87" (123.8mm)	4.94" (125.4mm)	1.56" (39.7mm)	1.81" (46.0mm)
	Oversize	5.25" (133.3mm)	5.31" (134.9mm)	1.75" (44.4mm)	1.81" (46.0mm)
3-Gang	Standard	4.50" (114.3mm)	6.37" (161.9mm)	1.37" (34.9mm)	1.81" (46.0mm)
	Mid-Size	4.87" (123.8mm)	6.75" (171.4mm)	1.56" (39.7mm)	1.81" (46.0mm)
	Oversize	5.25" (133.4mm)	7.17" (182.2mm)	1.75" (44.4mm)	1.81" (46.1mm)
4-Gang	Standard	4.50" (114.3mm)	8.19" (207.9mm)	1.37" (34.9mm)	1.81" (46.0mm)
	Mid-Size	4.87" (123.8mm)	8.56" (217.5mm)	1.56" (39.7mm)	1.81" (46.0mm)
	Oversize	5.25" (133.3mm)	8.94" (227.0mm)	1.75" (44.4mm)	1.81" (46.0mm)
5-Gang	Standard	4.50" (114.3mm)	10.00" (254.0mm)	1.37" (34.9mm)	1.81" (46.0mm)
	Mid-Size	4.87" (123.8mm)	10.37" (263.5mm)	1.56" (39.7mm)	1.81" (46.0mm)
6-Gang	Standard	4.50" (114.3mm)	11.81" (300.0mm)	1.37" (34.9mm)	1.81" (46.0mm)
	Mid-Size	4.87" (123.8mm)	12.18" (309.5mm)	1.56" (39.7mm)	1.81" (46.0mm)



**Toggle Switch**

Description	Material	Catalog No.	Colors		
1-Gang Toggle	Polycarbonate	<input type="checkbox"/> <b>PJ1</b> __	A, B, BK, GY, LA, RD, V, W		
	REPEL Polycarbonate	<input type="checkbox"/> <b>PJ1AM</b> __	GY, RD, V, W	•	
	Thermoset	<input type="checkbox"/> <b>2034</b> __	A, B, LA, V, W		•
	302/304 Stainless Steel	<input type="checkbox"/> <b>93971</b>	—		•
2-Gang Toggle	Polycarbonate	<input type="checkbox"/> <b>PJ2</b> __	A, B, BK, GY, LA, RD, V, W		
	REPEL Polycarbonate	<input type="checkbox"/> <b>PJ2AM</b> __	GY, RD, V, W	•	
	Thermoset	<input type="checkbox"/> <b>2039</b> __	A, B, LA, V, W		•
	302/304 Stainless Steel	<input type="checkbox"/> <b>93972</b>	—		•
3-Gang Toggle	Polycarbonate	<input type="checkbox"/> <b>PJ3</b> __	B, BK, GY, LA, RD, V, W		
	REPEL Polycarbonate	<input type="checkbox"/> <b>PJ3AM</b> __	GY, RD, V, W	•	
	Thermoset	<input type="checkbox"/> <b>2041</b> __	A, B, LA, V, W		•
	302/304 Stainless Steel	<input type="checkbox"/> <b>93973</b>	—		•
4-Gang Toggle	Polycarbonate	<input type="checkbox"/> <b>PJ4</b> __	A, B, BK, GY, LA, V, W		
	REPEL Polycarbonate	<input type="checkbox"/> <b>PJ4AM</b> __	GY, V, W	•	
	Thermoset	<input type="checkbox"/> <b>2054</b> __	A, LA, V, W		•
5-Gang Toggle	Polycarbonate	<input type="checkbox"/> <b>PJ5</b> __	A, B, BK, GY, LA, V, W		
6-Gang Toggle	Polycarbonate	<input type="checkbox"/> <b>PJ6</b> __	A, B, BK, GY, LA, V, W		



1-Gang

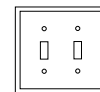

2-Gang

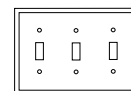

3-Gang

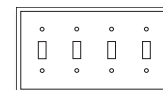

4-Gang

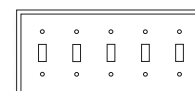

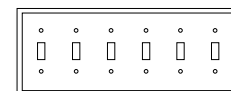

5-Gang



6-Gang

**Duplex Receptacle**

Description	Material	Catalog No.	Colors		
1-Gang	Polycarbonate	<input type="checkbox"/> <b>PJ8</b> __	A, B, BK, BL, GY, LA, RD, V, W		
	REPEL Polycarbonate	<input type="checkbox"/> <b>PJ8AM</b> __	GY, RD, V, W	•	
	Thermoset	<input type="checkbox"/> <b>2032</b> __	A, B, LA, V, W		•
	302/304 Stainless Steel	<input type="checkbox"/> <b>93901</b>	—		•
2-Gang	Polycarbonate	<input type="checkbox"/> <b>PJ82</b> __	A, B, BK, GY, LA, RD, V, W		
	REPEL Polycarbonate	<input type="checkbox"/> <b>PJ82AM</b> __	GY, RD, V, W	•	
	Thermoset	<input type="checkbox"/> <b>2050</b> __	A, V, LA, W		•
	302/304 Stainless Steel	<input type="checkbox"/> <b>93902</b>	—		•



1-Gang

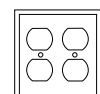



2-Gang

**Color Ordering Information**

For ordering wallplates, include Cat. No. followed by the color code: A (Almond), B (Brown), BK (Black), BL (Blue), GY (Gray), LA (Light Almond), RD (Red), RN (Orange), V (Ivory), W (White)

**Icon Key**

-  NAFTA Compliant - see page O-30
-  REPEL Wallplates - see page J-1

**Certifications**

2000 series wallplates are cULus certified  
 5000 series wallplates are cULus certified  
 90000 series wallplates are UL and CSA certified

**Specification Information:**

Wallplates: J-21

Wallplates

Standard Size  
Mid-Size  
Oversize  
REPEL

	Wallplate Type	Standard Size, Mid-Sized & Oversize Wallplates				REPEL	
	Material Type	Thermoset	Nylon	Stainless Steel	Polycarbonate	REPEL Polycarbonate Mid-Sized Wallplates PJ_AM and PJS_AM Series	REPEL Stainless Steel Standard Size Wallplates 93070_AM, 93090_AM, 93100_AM, 93400_AM Series
	Manufacturing Process	Injection Molded	Injection Molded	Stamped	Injection Molded	Injection Molded	Stamped
	Testing & Code Compliance	UL Listed to UL 514D, file no. E33216	UL Listed to UL 514D, file no. E33216	UL Listed to UL 514D, file no. E92003	UL Listed to UL 514D, file no. E33216	UL Listed to UL 514D, file no. E33216	UL Listed to UL 514D, file no. E92003
		cUL certified to C22.2, no. 42.1, UL file E33216	cUL certified to C22.2, no. 42.1, UL file E33216	CSA certified to C22.2, no. 42.1	cUL, UL file E33216 certified to C22.2, no. 42.1	Agion® Antimicrobial Additive: EPA approved for use as product ingredient	Agion® Antimicrobial Additive: EPA approved for use as product ingredient
Specifications: Environmental	Flammability	Meets UL 94 requirements; 5V rated	Meets UL 94 requirements; 5V rated	N/A	Meets UL 94 requirements 5VA rated	Meets UL 94 requirements; 5V rated	N/A
	Temperature Rating	-40°C to 90°C (-40°F to 194°F)	-40°C to 70°C (-40°F to 158°F)	-40°C to 70°C (-40°F to 158°F)	-40° to 70° C (-40°F to 158°F)	-40°C to 70°C (-40°F to 158°F)	-40°C to 70°C (-40°F to 158°F)
Materials:	Body	0.080" thick thermoset urea or phenolic	0.060" thick thermoplastic	0.032" thick stainless steel alloy, 18% chromium and 8% nickel for corrosion resistance	0.08" thick thermoplastic polycarbonate	0.071" thick polycarbonate with Agion® Antimicrobial Additive incorporated	0.032" thick 302/304 stainless steel alloy, 18% chromium and 8% nickel for corrosion resistance, DuPont® Alesta® powder coating with Agion® Antimicrobial incorporated
	Inner Wallplate	N/A	N/A	N/A	0.071" thick polycarbonate	PJS_AM only: 0.071" thick polycarbonate	N/A

NOTE: REPEL products do not protect the user against disease causing organisms and ongoing regular cleaning practices should be maintained. Agion is a registered trademark of Agion Technologies, Inc., Wakefield, MA