

Electrical Sector Solutions

Volume 9: OEM



EATON

Powering Business Worldwide

Tab 1—Circuit Protection	V9-T1-1
Tab 2—Motor Control and Protection	V9-T2-1
Tab 3—Logic Devices	V9-T3-1
Tab 4—Operator Interface	V9-T4-1
Tab 5—Sensors and Limit Switches	V9-T5-1
Tab 6—Machine Integration	V9-T6-1
Appendix 1—Eaton Terms & Conditions	V9-A1-1



Dimensions, Weights and Ratings

Dimensions, weights and ratings given in this catalog **are approximate and should not be used for construction purposes**. Drawings containing exact dimensions are available upon request. All listed product specifications and ratings are subject to change without notice. Photographs are representative of production units.

Terms and Conditions

All prices and discounts are subject to change without notice. When price changes occur, they are published in Eaton's *Price and Availability Digest* (PAD). All orders accepted by Eaton's Electrical Sector are subject to the general terms and conditions as set forth in Appendix 1—Eaton Terms & Conditions.

Technical and Descriptive Publications

This catalog contains brief technical data for proper selection of products. Further information is available in the form of technical information publications and illustrated brochures. If additional product information is required, contact your local Eaton Products Distributor, call **1-800-525-2000** or visit our website at **www.eaton.com**.

Compliance with Nuclear Regulation 10 CFR 21

Eaton products are sold as commercial grade products not intended for application in facilities or activities licensed by the United States Nuclear Regulatory Commission for atomic purposes, under 10 CFR 21. Further certification will be required for use of these products in a safety-related application in any nuclear facility licensed by the U.S. Nuclear Regulatory Commission.

WARNING

The installation and use of Eaton products should be in accordance with the provisions of the U.S. National Electrical Code® and/or other local codes or industry standards that are pertinent to the particular end use. Installation or use not in accordance with these codes and standards could be hazardous to personnel and/or equipment.

These catalog pages do not purport to cover all details or variations in equipment, nor to provide for every possible contingency to be met in connection with installation, operation or maintenance. Should further information be desired or should particular problems arise which are not covered sufficiently for the purchaser's purposes, the matter should be referred to the local Eaton Products Distributor or Sales Office. The contents of this catalog shall not become part of or modify any prior or existing agreement, commitment or relationship. The sales contract contains the entire obligation of Eaton's Electrical Sector. The warranty contained in the contract between the parties is the sole warranty of Eaton. Any statements contained herein do not create new warranties or modify the existing warranty.



Powering Business Worldwide

Eaton is a global leader in power distribution, power quality, control and automation, and monitoring products.

At Eaton, we believe a reliable, efficient and safe power system is the foundation of every successful enterprise. Through innovative technologies, cutting-edge products and our highly skilled services team, we empower businesses around the world to achieve a powerful advantage.

In addition, Eaton is committed to creating and maintaining powerful customer relationships built on a foundation of excellence. From the products we manufacture to our dedicated customer service and support, we know what's important to you.

Solutions

Eaton takes the complexity out of power systems management with a holistic and strategic approach, leveraging our industry-leading technology, solutions and services. We focus on the following three areas in all we do:

- Reliability—maintain the appropriate level of power continuity without disruption or unexpected downtime
- Efficiency—minimize energy usage, operating costs, equipment footprint and environmental impact
- Safety—identify and mitigate electrical hazards to protect what you value most

Using the Eaton Catalog Library

As we grow, it becomes increasingly difficult to include all products in one or two comprehensive catalogs. Knowing that each user has their specific needs, we have created a library of catalogs for our products that when complete, will contain 15 volumes. Since the volumes will continuously be a work in progress and updated, each volume will stand alone. Refer to our volume directory, MZ08100001E, for a quick glance of where to look for the products you need. The 15 volumes include:

- Volume 1—Residential and Light Commercial (CA08100002E)
- Volume 2—Commercial Distribution (CA08100003E)
- Volume 3—Power Distribution and Control Assemblies (CA08100004E)
- Volume 4—Circuit Protection (CA08100005E)
- Volume 5—Motor Control and Protection (CA08100006E)
- Volume 6—Solid-State Motor Control (CA08100007E)
- Volume 7—Logic Control, Operator Interface and Connectivity Solutions (CA08100008E)
- Volume 8—Sensing Solutions (CA08100010E)
- Volume 9—Original Equipment Manufacturer (CA08100011E)
- Volume 10—Enclosed Control (CA08100012E)
- Volume 11—Vehicle and Commercial Controls (CA08100013E)
- Volume 12—Aftermarket, Renewal Parts and Life Extension Solutions (CA08100014E)
- Volume 13—Counters, Timers and Tachometers (CA08100015E)—Available in electronic format only
- Volume 14—Fuses (CA08100016E)—Available in electronic format only
- Volume 15—Solar Inverters and Electrical Balance of System (CA08100018E)

These volumes are not all-inclusive of every product, but they are meant to be an overview of our product lines. For our full range of product solutions and additional product information, consult Eaton.com/electrical and other catalogs and product guides in our literature library. These references include:

- The Consulting Application Guide (CA08104001E)
- The Eaton Power Quality Product Guide (COR01FYA)

If you don't have the volume that contains the product or information that you are looking for, not to worry. You can access every volume of the catalog library at Eaton.com/electrical in the Literature Library.

By installing our Automatic Tab Updater (ATU), you can be sure you always have the most recent version of each volume and tab.

Circuit Breakers



Fuse Blocks and Fuse Holders



Rotary Disconnect Switches



1.1 Circuit Breakers

Product Overview	V9-T1-2
Series G Molded Case Circuit Breakers	V9-T1-5
Series G Motor Circuit Protectors	V9-T1-8
Series G Motor Protector Breakers	V9-T1-10
Universal Molded Case Circuit Breakers	V9-T1-13
QUICKLAG Type QC Miniature Circuit Breakers— Cable-In/Cable-Out Type QC	V9-T1-19
FAZ-NA UL 489 Circuit Breakers	V9-T1-25
FAZ UL 1077 Circuit Breakers	V9-T1-28
Series NRX Low Voltage Power Breakers	V9-T1-33
Magnum Low Voltage Power Breakers	V9-T1-36

1.2 Fuse Blocks and Fuse Holders

Product Overview	V9-T1-44
C350 Series	V9-T1-45

1.3 Rotary Disconnect Switches

Open Rotary Disconnects	V9-T1-46
Enclosed Rotary Disconnects	V9-T1-62

For our complete product offering, see Volume 4—Circuit Protection, CA08100005E and Volume 5—Motor Control and Protection, CA08100006E.

Product Overview

Circuit Breaker Selection Guide



Description	Series G Molded Case Circuit Breaker		Universal Molded Case Circuit Breakers		QUICKLAG® Type QC Miniature Circuit Breakers
	Page V9-T1-5		Page V9-T1-13		Page V9-T1-19
General Applications	Line protection—molded case switch, motor circuit protection (combination tested with Eaton starters and contactors) thermal-magnetic and electronic trip units.		Line protection—feeder and branch thermal-magnetic trip unit.		Used to provide branch circuit protection in cable-in/out panel or DIN rail mount applications.
Technical Data					
Maximum current rating	2500A		600A		100A
Maximum voltage—AC	690 Vac		480 Vac		240 Vac
Maximum voltage—DC	250 Vdc		250 Vdc		80 Vdc
Poles	1, 2, 3, 4		1, 2, 3		QC = 1, 2, 3, 4 QCD = 1, 2, 3 QCR/QCF = 1, 2, 3
Max. interrupting capacities See individual catalogs for limitations and back-up protection requirements.	Three-pole at 240V E = 200 kA J = 200 kA L = 200 kA	Three-pole at 480V E = 100 kA J = 200 kA L = 200 kA	Three-pole at 240V G = 25 kA (480/277) F = 25 kA J = 35 kA K = 35 kA L = 35 kA	Three-pole at 480V GI = 14 kA (480/277) GD = 22 kA F = 14 kA J = 20 kA K = 20 kA L = 20 kA	65 kA at 240 Vac 5 kA at 80 Vdc
Approvals	UL® 489 IEC 60947-2 CE	CSA® KEMA-KEUR CCC	UL 489CE IEC 60947-2	CE CSA	UL 489 CSA 22.2
Environmental Data					
Humidity	Non-condensing 100% relative humidity		Non-condensing 100% relative humidity		—
Shock	—		—		—
Vibration	—		—		—
Operating temperature	–20° to 70°C (–4° to 158°F) derating applies		–20° to 70°C (–4° to 158°F) derating applies		40°C (104°F)
Dielectric strength	Below 250A 6 kV Above 250A 8 kV		Below 250A 6 kV Above 250A 8 kV		1960 Vac (acc. to UL 489)
Insulation resistance	750 Vac		750 Vac		—
Endurance/life	250A: EG, JG = 8,000 operations 630A: LG = 6,000 operations		250A: Gi = 10,000 operations Fi = 8,000 operations 400A: Ji, Ki, Li = 6,000 operations		>10,000 operations
Approximate weight	E Three-pole—2.88 lbs (1.04 kg) J Three-pole—5.06 lbs (2.30 kg) L Three-pole—12.36 lbs (5.61 kg)		G Three-pole—2.10 lbs (0.95 kg) F Three-pole—4.5 lbs (2.0 kg) J Three-pole—12.50 lbs (5.7 kg) K Three-pole—11.50 lbs (5.2 kg)		QC Single-pole—0.36 lbs (162.8 g) Two-pole—0.61 lbs (274.9 g) Three-pole—1.14 lbs (518.3 g) QCD Single-pole—0.43 lbs (195.3 g) Two-pole—0.89 lbs (401.9 g) Three-pole—1.34 lbs (605.6 g) QCR Single-pole—0.22 lbs (97.9 g) Two-pole—0.48 lbs (215.8 g) Three-pole—0.70 lbs (315.6 g) QCF Single-pole—0.24 lbs (109.9 g) Two-pole—0.50 lbs (225.2 g) Three-pole—0.74 lbs (335.1 g)
Mounting configuration	Backpan, plug-in adapter, DIN rail (E)		Backpan, DIN rail (G)		Panel mount, front mount, 35 mm DIN rail mountable

For our complete product offering, see Volume 4—Circuit Protection, CA08100005E.

Circuit Breaker Selection Guide, continued



FAZ-NA UL 489
Miniature Circuit Breakers



FAZ UL 1077
Miniature Circuit Breakers—
Supplementary Protectors

Description	FAZ-NA UL 489 Miniature Circuit Breakers Page V9-T1-25	FAZ UL 1077 Miniature Circuit Breakers— Supplementary Protectors Page V9-T1-28
General Applications	Used to provide branch circuit protection in cable-in/out DIN rail mount applications.	Used to provide overcurrent protection where branch protection (for example UL 489 MCCB) is already provided or not required. Replacement for fuses used as supplementary protectors.
Technical Data		
Maximum current rating	40A	63A
Maximum voltage—AC	480/277 Vac (240/415 Vac IEC)	480/277 Vac
Maximum voltage—DC	48 Vdc	65 Vac Single-pole 130 Vac Two-pole
Poles	1, 2, 3	1, 2, 3
Max. interrupting capacities See individual catalogs for limitations and back-up protection requirements.	10 kA UL/CSA; 15 kA IEC/EN 60947-2	IEC 240/415V 10 kA UL/CSA 120V 10 kA 240V 10 kA 277V 6 kA 480V 6 kA
Approvals	UL 489 CE; IEC/EN 60947-2 CSA 22.2	UL 1077 CE; IEC/EN 60947-2; IEC/EN 60898 CSA 22.2 235
Environmental Data		
Humidity	Acc. IEC 60068-2 (25° to 55°C/ 77° to 131°F, 90–95% RH)	—
Shock	Acc. IEC 60068-2-27 (40g half sine wave for 10 ms—3 axes) (15g half sine wave for 20 ms—3 axes)	—
Vibration	Acc. to IEC 60068-2-6 5–100 Hz/1.0 mm/0.7g (3 axes)	—
Operating temperature	30°C (86°F)	—
Dielectric strength	1960 Vac (acc. to UL 489)	—
Insulation resistance	100M ohms at 500 Vdc	—
Endurance/life	>20,000 operations	—
Approximate weight	Single-pole—0.27 lbs (121.0g) Two-pole—0.53 lbs (242.0g) Three-pole—0.80 lbs (363.0g)	Single-pole—0.26 lbs (120.0g) Two-pole—0.54 lbs (244.9g) Three-pole—0.83 lbs (376.5g)
Mounting contribution	35 mm DIN rail mountable	35 mm DIN rail mountable

For our complete product offering, see Volume 4—Circuit Protection, CA08100005E.

Circuit Breaker Selection Guide, continued



**Series NRX
Low Voltage Power Breakers**



**Magnum
Low Voltage Power Breakers**

Description	Series NRX Low Voltage Power Breakers	Magnum Low Voltage Power Breakers
	Page V9-T1-33	Page V9-T1-36
General Applications	Solution for where space is at a premium or when equipment dimensions are critical when upgrading or retrofitting current systems. Offering the power and performance of a power breaker in the compact size of a molded case breaker. With its reduced weight and compact dimensions, you can mount two times as many feeder breakers and reduce the overall enclosure density up to 50%.	Enables comprehensive solutions to meet and exceed the unique and wide-ranging requirements of today's global power distribution systems. Designed and engineered for ultimate custom configuration and application flexibility in metal enclosed switchgear and power distribution enclosures.
Technical Data		
Maximum current rating	630–1600A	800–6300A
Maximum voltage—AC	220–690 Vac	Up to 690 Vac
Maximum voltage—DC	—	—
Poles	3, 4	3, 4
Max. interrupting capacities See individual catalogs for limitations and back-up protection requirements.	65 kAIC at 480 Vac Max. withstand capacities 42 kAIC	200 kA at 480 Vac Max. withstand capacities 100 kAIC CL fuseless 200 kA at 635 Vac with integral limiters
Approvals	UL 1006 Component UL 489 Component IEC 60947-2	UL 1066 IEC 60947-2 KEMA
Environmental Data		
Humidity	—	—
Shock	—	—
Vibration	—	—
Operating temperature	–25° to 70°C	–25° to 70°C
Dielectric strength	—	—
Insulation resistance	—	—
Endurance/life	10,000 electrical operations 20,000 mechanical operations	—
Approximate weight	Three-pole breaker + cassette—85 lbs (39 kg) Three-pole breaker—53 lbs (24 kg) Four-pole breaker + cassette—104 lbs (47 kg) Four-pole breaker—67 lbs (30 kg)	—
Mounting configuration	Rear-connected, front-connected, surface mounting, mounting bracket, fixed, drawout breaker with cassette	Fixed or drawout with cassette rear-connected, front-connected

For our complete product offering, see Volume 4—Circuit Protection, CA08100005E.

Series G Molded Case Circuit Breakers



Features

- Field-fit accessories
- Common accessories through 630A
- Space-saving footprint
- High-performance current limiting designs up to 200 kAIC at 480V
- Global ready: UL, CSA, CE, IEC, KEMA-KEUR listings
- Complete breaker includes frame, trip unit, standard terminals and mounting hardware

Catalog Number Selection

Series G® Molded Case Circuit Breakers

EG Frame

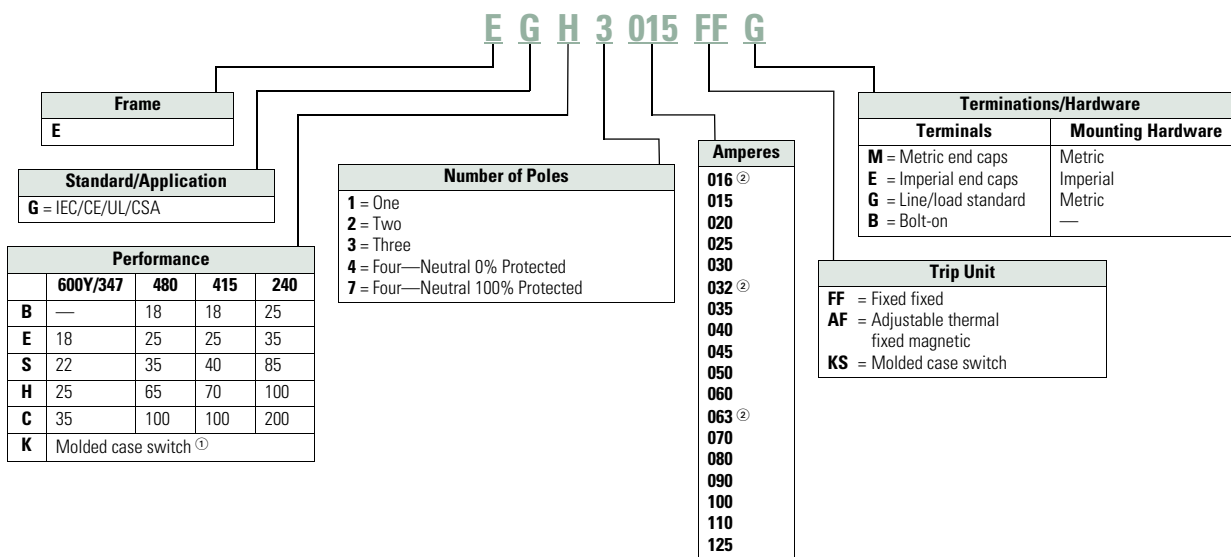

Notes

- ① Available only as 125 and 160A sizes.
- ② Is not UL rated.

1.1

Circuit Protection

Circuit Breakers

1

JG Frame

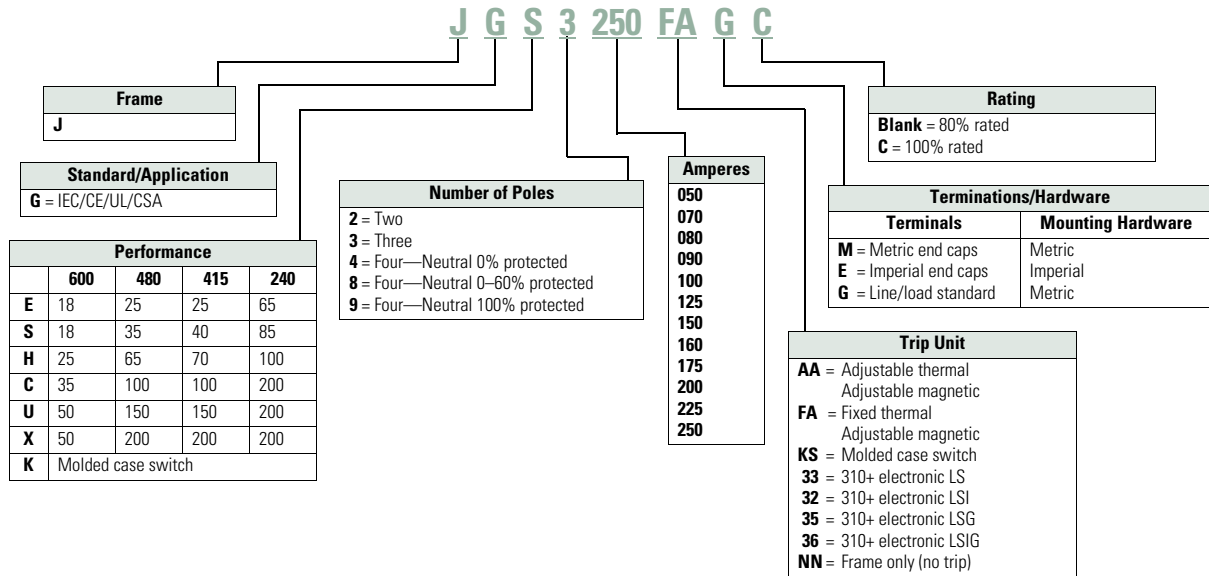

LG Frame

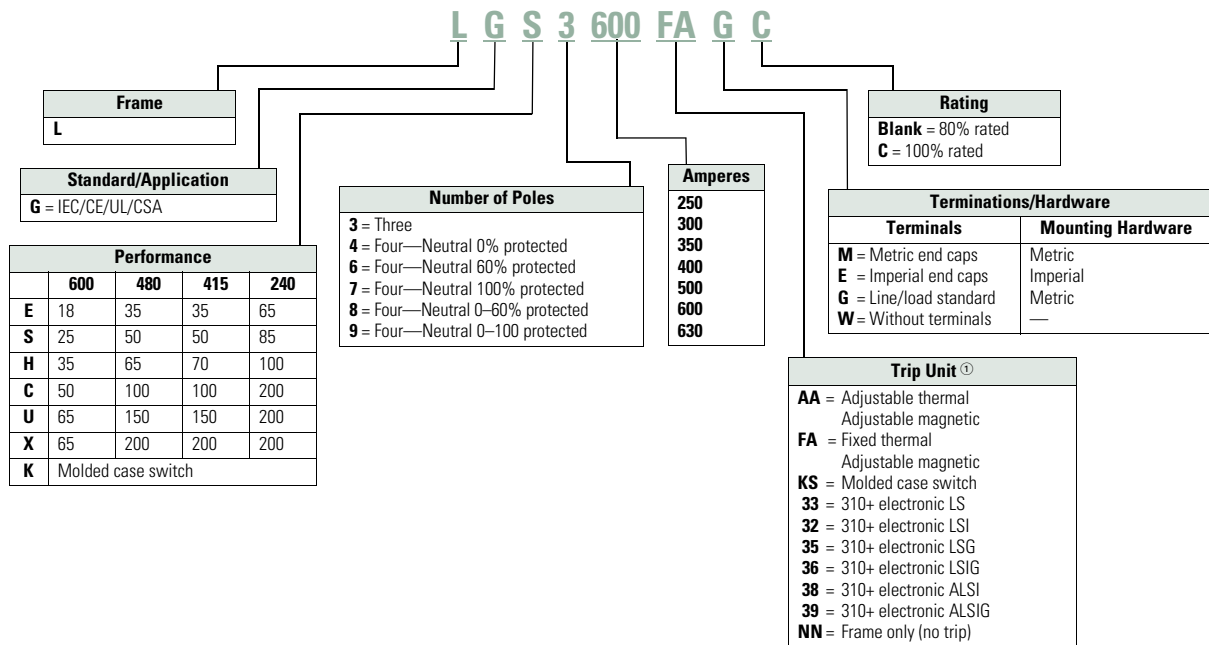

Note

① A = Arc reduction, L = Long, S = Short, I = Instantaneous, G = Ground.

Product Selection

Series G Molded Case Circuit Breakers

Approximate Dimensions are in Inches

EG Frame

Maximum Continuous Amperes at 40°C ①	Three-Pole 3.00 W x 5.50 H x 2.99 D Fixed Thermal Fixed Magnetic
IC Rating: 25 kAIC at 415 and 480 Vac	
15	EGE3015FFG
20	EGE3020FFG
25	EGE3025FFG
30	EGE3030FFG
35	EGE3035FFG
40	EGE3040FFG
45	EGE3045FFG
50	EGE3050FFG
60	EGE3060FFG
70	EGE3070FFG
80	EGE3080FFG
90	EGE3090FFG
100	EGE3100FFG
125	EGE3125FFG

Maximum Continuous Amperes at 40°C	Three-Pole 3.00 W x 5.50 H x 2.99 D Fixed Thermal Fixed Magnetic
IC Rating: 70 kAIC at 415 Vac, 65 kAIC at 480 Vac	
15	EGH3015FFG
20	EGH3020FFG
25	EGH3025FFG
30	EGH3030FFG
35	EGH3035FFG
40	EGH3040FFG
45	EGH3045FFG
50	EGH3050FFG
60	EGH3060FFG
70	EGH3070FFG
80	EGH3080FFG
90	EGH3090FFG
100	EGH3100FFG
125	EGH3125FFG

JG Frame

Maximum Continuous Amperes	Three-Pole 4.13 W x 7.00 H x 3.57 D Magnetic Range	Fixed Thermal Adjustable Magnetic
IC Rating: 25 kAIC at 415 and 480 Vac		
70	350–700	JGE3070FAG
90	450–900	JGE3090FAG
100	500–1000	JGE3100FAG
125	625–1250	JGE3125FAG
150	750–1550	JGE3150FAG
175	875–1750	JGE3175FAG
200	1000–2000	JGE3200FAG
225	1125–2250	JGE3225FAG
250	1250–2500	JGE3250FAG

Maximum Continuous Amperes	Three-Pole 4.13 W x 7.00 H x 3.57 D Magnetic Range	Fixed Thermal Adjustable Magnetic
IC Rating: 70 kAIC at 415 Vac, 65 kAIC at 480 Vac		
70	350–700	JGH3070FAG
90	450–900	JGH3090FAG
100	500–1000	JGH3100FAG
125	625–1250	JGH3125FAG
150	750–1550	JGH3150FAG
175	875–1750	JGH3175FAG
200	1000–2000	JGH3200FAG
225	1125–2250	JGH3225FAG
250	1250–2500	JGH3250FAG

LG Frame

Ampere Rating	Three-Pole 5.48 W x 10.13 H x 4.09 D Fixed Thermal Adjustable Magnetic
IC Rating: 35 kAIC at 415 and 480 Vac	
250	LGE3250FAG
300	LGE3300FAG
350	LGE3350FAG
400	LGE3400FAG
500	LGE3500FAG
600	LGE3600FAG

Ampere Rating	Three-Pole 3.00 W x 5.50 H x 2.99 D Fixed Thermal Adjustable Magnetic
IC Rating: 70 kAIC at 415 Vac, 65 kAIC at 480 Vac	
250	LGH3250FAG
300	LGH3300FAG
350	LGH3350FAG
400	LGH3400FAG
500	LGH3500FAG
600	LGH3600FAG

Note

① 16, 32, 63A are not UL listed ratings.

Series G Motor Circuit Protector



Features

- Instantaneous only protector
- Designed for use in combination with motor starters
- Adjustable to motor FLA
- UL recognized component, File E7819 motor circuit protectors

Product Selection

Series G Motor Circuit Protectors

EG Frame—480 Vac, 600Y/347 Vac Maximum

Continuous Amperes	Cam Setting	Motor Full Load Current Amperes ^①	MCP Trip Setting ^②	MCP Catalog Number
3	A	0.69–0.91	9	HMCPE003A0C
	B	1.1–1.3	15	
	C	1.6–1.7	21	
	D	2.0–2.2	27	
	E	2.3–2.5	30	
	F	2.6–2.8	33	
7	A	1.5–2.0	21	HMCPE007C0C
	B	2.6–3.1	35	
	C	3.7–3.9	49	
	D	4.8–5.2	63	
	E	5.3–5.7	70	
	F	5.8–6.1	77	
15	A	3.4–4.5	45	HMCPE015E0C
	B	5.7–6.8	75	
	C	8.0–9.1	105	
	D	10.4–11.4	135	
	E	11.5–12.6	150	
	F	12.7–13.0	165	
30	A	3.9–9.1	90	HMCPE030H1C
	B	11.5–13.7	150	
	C	16.1–18.3	210	
	D	20.7–22.9	270	
	E	23.0–25.2	300	
	F	25.3–26.1	330	

Continuous Amperes	Cam Setting	Motor Full Load Current Amperes ^①	MCP Trip Setting ^②	MCP Catalog Number
50	A	11.5–15.2	150	HMCPE050K2C
	B	19.2–22.9	250	
	C	26.9–30.6	350	
	D	34.6–38.3	450	
	E	38.4–42.1	500	
	F	42.2–43.5	550	
70	A	16.1–30.6	210	HMCPE070M2C
	B	26.9–32.2	350	
	C	37.6–42.9	490	
	D	48.4–53.7	630	
	E	53.8–59.1	700	
	F	59.2–60.9	770	
100	A	23.0–30.6	300	HMCPE100R3C
	B	38.4–46.0	500	
	C	53.8–61.4	700	
	D	69.2–76.8	900	
	E	76.9–84.5	1000	
	F	84.6–87.0	1100	
100	A	38.4–46.0	500	HMCPE100T3C
	B	57.6–65.2	750	
	C	76.9–84.5	1000	
	D	③	1250	
	E	③	1375	
	F	③	1500	

Notes

- ① Motor FLA ranges are typical. The corresponding trip setting is at 13 times the minimum FLA value shown. Where a 13 times setting is required for an intermediate FLA value, alternate cam settings and/or MCP ratings should be used.
- ② For DC applications, actual trip levels are approximately 40% higher than values shown.
- ③ Settings above 10 x I_n are for special applications, where the ampere rating of the disconnecting means cannot be less than 115% of the motor full load ampere rating.

JG Frame—600 Vac Maximum, 250 Vdc Maximum

Continuous Amperes	MCP Trip Range Amperes	MCP Catalog Number
250	500–1000	HMCPJ250D5L
	625–1250	HMCPJ250F5L
	750–1500	HMCPJ250G5L
	875–1750	HMCPJ250J5L
	1000–2000	HMCPJ250K5L
	1125–2250	HMCPJ250L5L
	1250–2500	HMCPJ250W5L

LG Frame—600 Vac Maximum, 250 Vdc Maximum

Continuous Amperes	MCP Trip Range Amperes	MCP Catalog Number
600	1250–2500	HMCP600L6G
	1500–3000	HMCP600N6G
	1750–3500	HMCP600R6G
	2000–4000	HMCP600X6G
	2250–4500	HMCP600Y6G
	2500–5000	HMCP600P6G
	3000–6000	HMCP600M6G

Series G Motor Protector Breakers**Features**

- Eliminates need for separate overload relay
- Can be used with contactor to eliminate need for overload relay and still create manual motor control
- Meets requirement for motor branch protection, including:
 - Disconnecting means
 - Branch circuit short-circuit protection
 - Overload protection
- UL 489 listed, IEC 60947-02 rated
- Phase unbalance, phase loss protection and high load alarm
- Optional pre-detection trip relay

Product Selection**Series G Motor Protector Breakers**

For pre-trip alarm option, order Style Number 5721B31G02.

**JG Frame Motor Protector Circuit Breakers,
250A Maximum Rated Current**

Continuous Amperes	35 kAIC Catalog Number	65 kAIC Catalog Number
50	JGMPS050G	JGMPH050G
100	JGMPS100G	JGMPH100G
160	JGMPS160G	JGMPH160G
250	JGMPS250G	JGMPH250G

**LG Frame Motor Protector Circuit Breakers,
630A Maximum Rated Current**

Continuous Amperes	50 kAIC Catalog Number	65 kAIC Catalog Number
250	LGMP250G	LGMPH250G
400	LGMP400G	LGMPH400G
600	LGMP600G	LGMPH600G
630 ^①	LGMP630G	LGMPH630G

Note

^① 630A is not a UL listed rating. 600A is the maximum UL or CSA rating for LG breaker.

Accessories

Field Fit Kit Catalog Numbers

	Description	Pole Location	Frame— EG, JG and LG
Alarm Lockout	Alarm Lockout		
	Make/break	Right	ALM1M1BEPK ①
	2 make/2 break	Right	ALM2M2BEPK ②

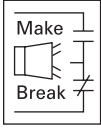

	Description	Pole Location	Frame— EG, JG and LG
Auxiliary Switch	Auxiliary Switch		
	1A, 1B	Right	AUX1A1BPK
	2A, 2B	Right	AUX2A2BPK

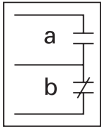

	Description	Pole Location	Frame— EG, JG and LG
Auxiliary Switch/Alarm Lockout	Auxiliary Switch/Alarm Lockout		
	—	Right	AUXALRMEPK ③

	Description	Pole Location	Frame— EG, JG and LG
Shunt Trip	Shunt Trip—Standard		
	120 Vac	Left	SNT120CPK ④
	240 Vac	Left	SNT120CPK ④
	12 Vdc	Left	SNT012CPK
	24 Vdc	Left	SNT060CPK
	48 Vdc	Left	SNT060CPK
	380–600 Vac	Left	SNT480CPK ⑤

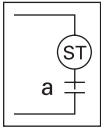

	Description	Pole Location	Frame— EG, JG and LG
Undervoltage Release Mechanism	Undervoltage Release Mechanism		
	110–127 Vac	Left	UVR120APK
	208–240 Vac	Left	UVR240APK
	24 Vac	Left	UVR024APK
	24 Vdc	Left	UVR024DPK
	48–60 Vdc	Left	UVR048DPK
	12 Vac/Vdc	Left	UVR012CPK
	48–60 Vac	Left	UVR048APK
	120 Vdc	Left	UVR125DPK
	220–250 Vdc	Left	UVR250DPK
	380–500 Vac	Left	UVR480APK
525–600 Vac	Left	UVR600APK	

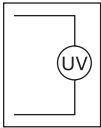

Multiwire Connectors Ordering Information (Package of 3)

High SCCR ratings are available for Power Distribution blocks with Series G MCCBs. See **Tab 6**.

Maximum Amperes	Wires per Terminal	Wire Size Range AWG Cu	Frame	Kit Catalog Number
125	3	14–2	EG	3TA125E3K
125	6	14–6	EG	3TA125E6K
250	3	14–2	JG	3TA250FJ3
250	6	14–6	JG	3TA250FJ6

Terminal Shields

Location	Number of Poles	Frame	IP30 Protection Catalog Number
Line	3	EG	EFTS3K
Line	4	EG	EFTS4K
Line or load	2, 3	JG	FJTS3K
Line or load	4	JG	FJTS4K

Interphase Barriers (Package of 2)

Number of Poles	Frame	Catalog Number
3 or 4	EG	EIPBK
3	JG	FJIPBK
4	JG	FJIPBK4
3 or 4	LG	IPB3

Flex Shaft Handles

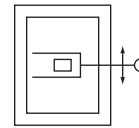

Flex Shaft Handle Mechanisms

Breaker Frame	Flexible Shaft Length in ft (m)	
	4 (1.2)	7 (2.1)
	Catalog Number	Catalog Number
EG	EHMFS04	EHMFS07
JG	JHMFS04	JHMFS07
LG	LHMFS04	LHMFS07

Universal Direct Handle Mechanism



Universal Direct Handle Mechanisms

Frame	With Interlock Catalog Number	Without Interlock Catalog Number
Black Handle Color		
EG	EHMCCBI	EHMCCB
JG	JHMCCBI	JHMCCB
LG	LHMCCBI	LHMCCB
Red Handle Color		
EG	EHMCCRI	EHMCCR
JG	JHMCCRI	JHMCCR
LG	LHMCCRI	LHMCCR

Notes

- ① Part number for JG and LG is ALM1M1BJPK.
- ② Part number for JG and LG is ALM2M2BJPK.
- ③ Part number for JG and LG is AUXALRMJPK.
- ④ 110–125 Vdc, 50/60 Hz.
- ⑤ 380–600 Vdc, 50/60 Hz.

Rotary Handle Mechanisms



High Performance Rotary Handle Mechanisms (Complete Kit Includes Handle, Shaft and Mechanism)

Color	Rating Type UL	IP	EG Frame ^① Catalog Number	JG Frame Catalog Number	LG Frame Catalog Number
Black/blue	1/12/3R	20/54/55	EGHMVD06B	JGHMVD06B	LGHMVD06B
			EGHMVD12B	JGHMVD12B	LGHMVD12B
			EGHMVD24B	JGHMVD24B	LGHMVD24B
Red/yellow	1/12/3R	20/54/55	EGHMVD06R	JGHMVD06R	LGHMVD06R
			EGHMVD12R	JGHMVD12R	LGHMVD12R
			EGHMVD24R	JGHMVD24R	LGHMVD24R
Black/blue	4/4X	66	EGHMVD06BX	JGHMVD06BX	LGHMVD06BX
			EGHMVD12BX	JGHMVD12BX	LGHMVD12BX
			EGHMVD24BX	JGHMVD24BX	LGHMVD24BX
Red/yellow	4/4X	66	EGHMVD06RX	JGHMVD06RX	LGHMVD06RX
			EGHMVD12RX	JGHMVD12RX	LGHMVD12RX
			EGHMVD24RX	JGHMVD24RX	LGHMVD24RX

External Accessories

Description	Fit Type	Frame EG	JG	LG
Non-padlockable handle block	Field	EFHB	—	—
Padlockable handle block	Field	EFPHB	—	—
Padlockable handle block off-only	Field	EFPHBOFF	FJPHBOFF	LBHPOFF
Padlockable handle lock hasp	Field	EFPHL	FJPHL	LPHL
Padlockable handle lock hasp off-only	Field	EFPHLOFF	FJPHLOFF	LPHLOFF
Kirk key interlock kit ^{②③}	Field	—	KYKJG	KYKLG
Castell key interlock kit ^{③④}	Field	—	CTKJG	CTKLG
Slide bar interlock ^⑤	Field	EFSBI	FJSBI	LGSBI
Walking beam interlock	Three-pole	EG3WBI	JG3WBI	LG3WBI
	Four-pole	EG4WBI	JG4WBI	LG4WBI
Electrical operator	120/240 Vac	MOPEG240C	MOPJG240C	MOPLG240C
	125 Vdc	MOPEG240C	MOPJG240C	MOPLG240C
Plug-in adapters	Three-pole	PAD3E	PAD3J	PAD3L
	Four-pole	PAD4E	PAD4J	PAD4L
Rear connecting studs	Field	EFRCSDL	FJRCSDL	3P-LRCS3WK
		EFRCSDS	FJRCSDS	4P-LRCS4WK
		EFRCSWL	FJRCSWL	—
		EFRCSWS	FJRCSWS	—

Notes

- ① Compatible with three-pole and four-pole EG breakers only.
- ② Provision only.
- ③ See Volume 4—Circuit Protection, CA08100005E, Tab 2, for bolt projection dimensions.
- ④ Castell bolt mounting hole must be 10 mm.
- ⑤ Requires two breakers.

Universal Molded Case Circuit Breakers



Features

- Universal design for both NEMA® (UL 489) and IEC (IEC 947-2) standards
- Suitable for 50°C application
- Factory-sealed thermal magnetic trip unit
- Standard interrupting ratings
- Includes mounting hardware and terminals

Catalog Number Selection

Universal Molded Case Circuit Breakers

Universal Molded Case

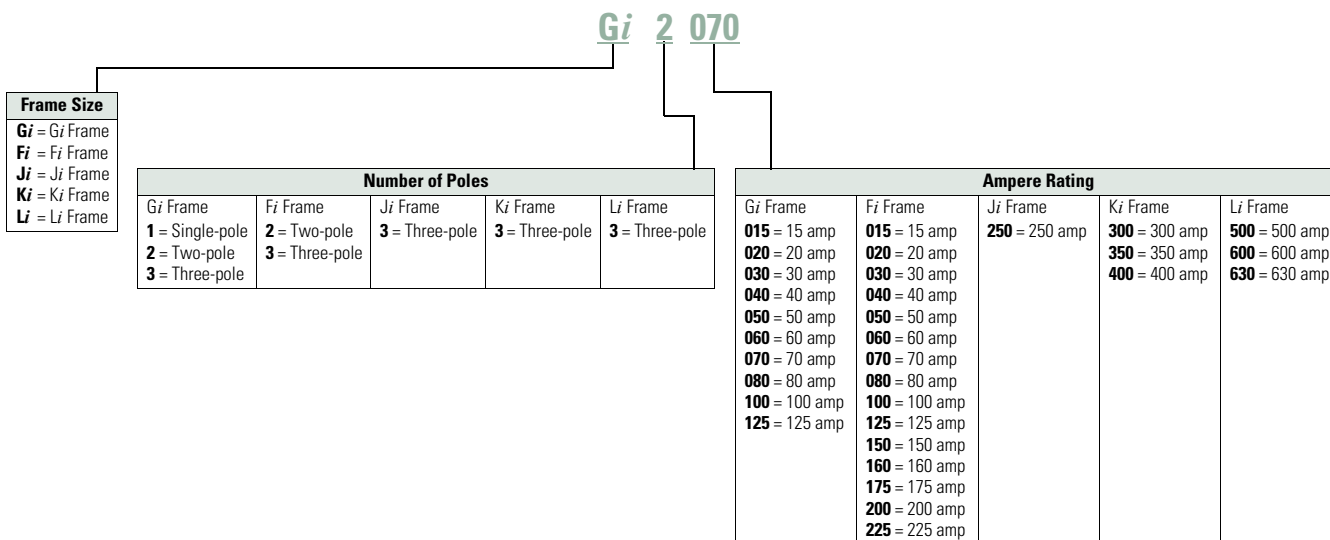

Product Selection

Universal Molded Case Circuit Breakers

Three-Pole

Approximate Dimensions are in Inches

Universal G Frame

Description	Amperes	Catalog Number ^①	
3 W x 4-7/8 H x 2-13/16 D (optional DIN rail kit available catalog number GDIN, package of ten)	15	Gi3015	
	20	Gi3020	
	25	Gi3025	
	30	Gi3030	
Voltage	Interrupting Rating		
380–415	18/5K	35	Gi3035
480/277	14K	40	Gi3040
		45	Gi3045
		50	Gi3050
		60	Gi3060

Universal F Frame

Description	Amperes	Catalog Number ^①	
4-1/8 W x 6 H x 3-3/8 D	15	Fi3015L	
	20	Fi3020L	
	30	Fi3030L	
	35	Fi3035L	
Voltage	Interrupting Rating		
415	18/9K	40	Fi3040L
480	20K	50	Fi3050L
		60	Fi3060L
		70	Fi3070L
		80	Fi3080L
		90	Fi3090L
		100	Fi3100L
		125	Fi3125L
		150	Fi3150L
		175	Fi3175L
		200	Fi3200L
		225	Fi3225L

Universal J Frame

Description	Amperes	Catalog Number ^①
4-1/8 W x 10 H x 4-1/16 D	225	Ji3225L
	250	Ji3250L
Voltage	Interrupting Rating	
415	25/13K	
480	20K	

Universal K Frame

Description	Amperes	Catalog Number ^①
5-1/2 W x 10-1/8 H x 4-1/16 D	300	Ki3300L
	350	Ki3350L
	400	Ki3400L
Voltage	Interrupting Rating	
415	25/13K	
480	20K	

Universal L Frame

Description	Amperes	Catalog Number ^①
8-1/4 W x 10-3/4 H x 4.37 D	500	Li3500
	600	Li3600
Voltage	Interrupting Rating	
415	25/13K	
480	20K	

Note

^① Metric mounting hardware.

Accessories

Internal Accessories

Auxiliary Switch (Right-Pole Mounted)

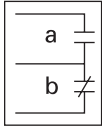

Bell Alarm (Right-Pole Mounted)

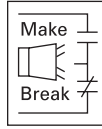

Shunt Trip (Left-Pole Mounted)

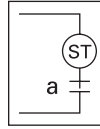

UVR (Left-Pole Mounted)

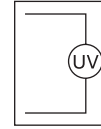

Configuration	Add This Suffix to Catalog Number	Configuration	Add This Suffix to Catalog Number	Voltage Range	Add This Suffix to Catalog Number	Voltage Range	Add This Suffix to Catalog Number
Universal G Frame							
1NO/1NC	A3	1 make/1 break	B3	24 Vac	S7	24 Vac 50/60 Hz	T2
2NO/2NC	A6			120 Vac	S1	48 Vac 50/60 Hz	T3
				240 Vac	S2	60 Vac 50/60 Hz	T4
				12 Vdc	S3	120 Vac 50/60 Hz	T1
				24 Vdc	S4	240 Vac 50/60 Hz	T8
						220 Vac 50 Hz	T7
						440 Vac 50 Hz	T11
						480 Vac 60 Hz	T12
Universal F Frame							
1NO/1NC	A06	1 make/1 break	B06	12–24 Vac/Vdc	S02	12 Vac	U02
2NO/2NC	A13			48–127 Vac or 48–60 Vdc	S06	24 Vac	U06
				208–380 Vac or 110–127 Vdc	S10	48 Vac/Vdc	U38
				415–600 Vac or 220–250 Vdc	S14	110–127 Vac	U14
						208–240 Vac	U18
						380–480 Vac	U22
						525–600 Vac	U26
						12 Vdc	U30
						24 Vdc	U34
						125 Vdc	U42
						220–250 Vdc	U46
Universal J Frame							
1NO/1NC	A06	1 make/1 break	B06	12–24 Vac/Vdc	S42	12 Vac	U06
2 NO/2NC	A13			48–60 Vac/Vdc	S50	24 Vac	U10
				110–240 Vac or 110–125 Vdc	S10	48–60 Vac	U14
				380–440 Vac or 220–50 Vdc	S14	110–127 Vac	U18
				480–600 Vac	S18	208–240 Vac	U22
						380–480 Vac	U26
						12 Vdc	T02
						24 Vdc	T06
						48–60 Vdc	T10
						110–125 Vdc	T14
						220–250 Vdc	T18

If both an auxiliary switch and bell alarm are required, add B13 to the catalog number (right-pole mounted). Auxiliary switch and bell alarm are 240V rated.

If both an auxiliary switch and bell alarm are required, add C05 to the catalog number (right-pole mounted). Auxiliary switch and bell alarm are 600V rated.

If both an auxiliary switch and bell alarm are required, add C05 to the catalog number (right-pole mounted). Auxiliary switch and bell alarm are 600V rated.

Internal Accessories, continued

Auxiliary Switch (Right-Pole Mounted)

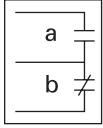

Bell Alarm (Right-Pole Mounted)

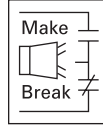

Shunt Trip (Left-Pole Mounted)

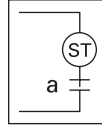

UVR (Left-Pole Mounted)

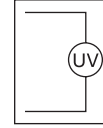

Configuration	Add This Suffix to Catalog Number	Configuration	Add This Suffix to Catalog Number	Voltage Range	Add This Suffix to Catalog Number	Voltage Range	Add This Suffix to Catalog Number
Universal K Frame							
1NO/1NC	A06	1 make/1 break	B06	12–24 Vac/Vdc	S42	12 Vac	U06
2NO/2NC	A13			48–60 Vac/Vdc	S50	24 Vac	U10
If both an auxiliary switch and bell alarm are required, add C05 to the catalog number (right-pole mounted). Auxiliary switch and bell alarm are 600V rated.				110–240 Vac or 110–125 Vdc	S10	48–60 Vac	U14
						110–127 Vac	U18
				380–440 Vac or 220–250 Vdc	S14	208–240 Vac	U22
						380–480 Vac	U26
				480–600 Vac	S18	12 Vdc	T02
						24 Vdc	T06
		48–60 Vdc	T10				
		110–125 Vdc	T14				
		220–250 Vdc	T18				
Universal L Frame							
1NO/1NC	A06	1 make/1 break	B06	12–24 Vac/Vdc	S02	12 Vac	U06
2NO/2NC	A13			48–60 Vdc	S06	24 Vac	U10
If both an auxiliary switch and bell alarm are required, add C05 to the catalog number (right-pole mounted). Auxiliary switch and bell alarm are 600V rated.				48–60 Vac	S86	48–60 Vac	U14
				110–240 Vac	S10	110–127 Vac	U18
				110–125 Vdc	S42	208–240 Vac	U22
				380–440 Vac or 220–250 Vdc	S14	380–480 Vac	U26
				480–600 Vac	S18	12 Vdc	T02
						24 Vdc	T06
		48–60 Vdc	T10				
		110–125 Vdc	T14				
		220–250 Vdc	T18				

Handle Mechanisms

Handle Mechanisms

Type 1/12 Universal Rotary

Ordering Information ^①



Shaft Length in Inches (mm)	Handle Color	Complete Catalog Number	Flange Flex Shaft Type 1, 3R, 12 Versions
Universal G Frame			
6 (152.4)	Black	GHMVD06B	3-ft length; order F0S03C
12 (304.8)	Black	GHMVD12B	4-ft length; order F0S04C
6 (152.4)	Red	GHMVD06R	5-ft length; order F0S05C
12 (304.8)	Red	GHMVD12R	6-ft length; order F0S06C
Universal F Frame			
6 (152.4)	Black	FHMVD06B	3-ft length; order F1S03C
12 (304.8)	Black	FHMVD12B	4-ft length; order F1S04C
6 (152.4)	Red	FHMVD06R	5-ft length; order F1S05C
12 (304.8)	Red	FHMVD12R	6-ft length; order F1S06C
			7-ft length; order F1S07C
			8-ft length; order F1S08C
			9-ft length; order F1S09C
			10-ft length; order F1S10C
Universal J Frame			
6 (152.4)	Black	JHMVD06B	3-ft length; order F2S03C
12 (304.8)	Black	JHMVD12B	4-ft length; order F2S04C
6 (152.4)	Red	JHMVD06R	5-ft length; order F2S05C
12 (304.8)	Red	JHMVD12R	6-ft length; order F2S06C
			7-ft length; order F2S07C
			8-ft length; order F2S08C
			9-ft length; order F2S09C
			10-ft length; order F2S10C
Universal K Frame			
6 (152.4)	Black	KHMVD06B	3-ft length; order F3S03C
12 (304.8)	Black	KHMVD12B	4-ft length; order F3S04C
6 (152.4)	Red	KHMVD06R	5-ft length; order F3S05C
12 (304.8)	Red	KHMVD12R	6-ft length; order F3S06C
			7-ft length; order F3S07C
			8-ft length; order F3S08C
			9-ft length; order F3S09C
			10-ft length; order F3S10C

Note

^① Only available as complete handle mechanism. Parts not sold separately.

Terminals and Termination Accessory Devices

Terminal/Termination Devices

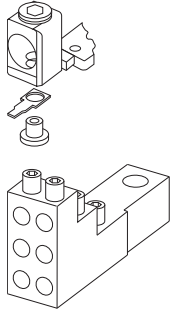

Universal G Frame

Terminals (Included with Breaker)		Optional Multiwire Lugs (Load End Only)	
15–20 A	25–100A	Three-Hole Version	Six-Hole Version
14–2 AWG Cu/Al	10–1/0 AWG Cu/Al	(3) 14–2 AWG Order 3TA100G3K	(6) 14–6 AWG Order 3TA100G6K
2.5–4 mm ² Cu/Al	4–50 mm ² Cu/Al		

Universal F Frame

Terminals (Included with Breaker)			Optional Multiwire Lugs (Load End Only)	
10–20A	25–100A	110–225A	Three-Hole Version	Six-Hole Version
14–10 AWG Cu/Al	14–1/0 AWG Cu/Al	4–4/0 AWG Cu/Al	(3) 14–2 AWG Order 3TA150F3K	(6) 14–6 AWG Order 3TA150F6K
2.5–4 mm ² Cu/Al	2.5–50 mm ² Cu/Al	25–95 mm ² Cu/Al		

Universal J Frame

Terminals (Included with Breaker)		Optional Multiwire Lugs (Load End Only)	
70–250A		Three-Hole Version	Six-Hole Version
4–350 kcmil AWG Cu/Al		(3) 14–2 AWG Order 3TA250J3K	(6) 14–6 AWG Order 3TA250J6K
25–150 mm ² Cu/Al			

Universal K Frame

Terminals (Included with Breaker)		Optional Multiwire Lugs (Load End Only)	
300–350A	400A	Three-Hole Version	Six-Hole Version
250–500 kcmil AWG Cu/Al	3/0–200 (2) AWG Cu/Al	(3) 12–2/0 AWG Order 3TA400K3K	(6) 14–2/0 AWG Order 3TA400K6K
120–240 mm ² Cu/Al	95–120 mm ² Cu/Al		

Universal L Frame

Terminals (Included with Breaker)		Optional Multiwire Lugs (Load End Only)	
500A	600A	Three-Hole Version	Six-Hole Version
(2) 250–300 kcmil Cu/Al	(2) 400–500 kcmil Cu/Al	—	—
120–150 mm ² Cu/Al	185–250 mm ² Cu/Al		

QUICKLAG Type QC Miniature Circuit Breakers—Cable-In/Cable-Out Type QC



Features

For Cable-In/Cable-Out Panel Mount Applications

- Single-, two-, three- and four-pole options
- Built and listed to UL 489
- All products UL and CSA listed
- All products 10–100A are HACR rated

Catalog Number Selection

QUICKLAG Type QC Miniature Circuit Breakers—Cable-In/Cable-Out Type QC

Type QC Miniature Circuit Breakers

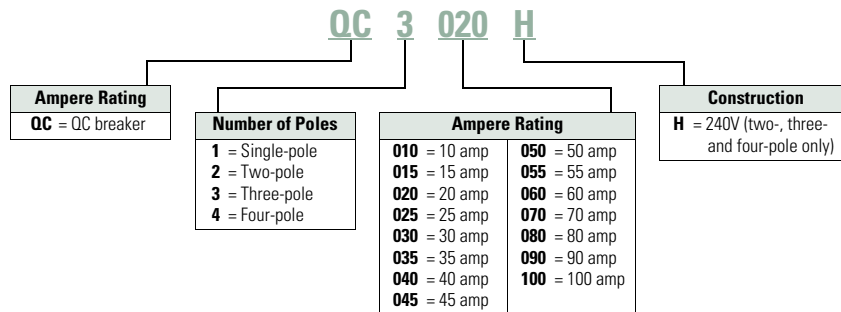

Product Selection

QUICKLAG Type QC 10,000 Ampere I.C. Thermal-Magnetic Breakers

Note: For non-automatic switches, see Volume 4—Circuit Protection, CA08100005E, Tab 1.

Continuous Ampere Rating at 40°C	Single-Pole, 120/240 Vac Catalog Number	Two-Pole, 120/240 Vac Catalog Number	Three-Pole, 240 Vac Catalog Number
10	QC1010	QC2010	—
15	QC1015 ①②	QC2015	QC3015H
20	QC1020 ①②	QC2020	QC3020H
30	QC1030	QC2030	QC3030H
40	QC1040	QC2040	QC3040H
50	QC1050	QC2050	QC3050H
60	—	QC2060	QC3060H
70	—	QC2070	QC3070H
100	QC1100	QC2100	QC3100H

Notes

- ① Switching duty rated for 120 Vac fluorescent light applications only.
- ② For special low-magnetic breaker, order QC1015L1 or QC1020L1.

QUICKLAG Type QC Miniature Circuit Breakers—Cable-In/Cable-Out Type QCD



Features

For Cable-In/Cable-Out DIN rail Mount HVAC Applications

- Single-, two- and three-pole options
- Modular construction
- DIN mounted (symmetrical rail 35 in x 7.5 in DIN/EN 50 022)
- Flexible power feed connection: wire size, position
- Same breaker size for entire rating range
- Field-mountable accessories: finger-shroud proof, quick connect terminals, jumper units

Catalog Number Selection

QUICKLAG Type QC Miniature Circuit Breakers—Cable-In/Cable-Out Type QCD

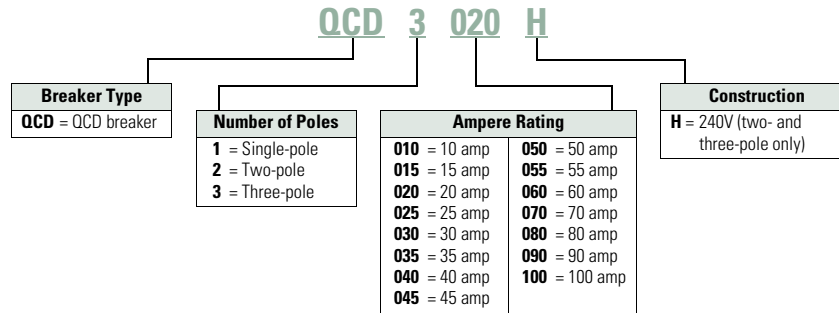

Product Selection

QUICKLAG Type QCD 10,000 Ampere I.C. Thermal-Magnetic Breakers

Continuous Ampere Rating at 40°C	Single-Pole, 120/240 Vac Catalog Number	Two-Pole, 120/240 Vac Catalog Number	Three-Pole, 240 Vac Catalog Number
10	QCD1010	QCD2010	—
15	QCD1015	QCD2015	QCD3015H
20	QCD1020	QCD2020	QCD3020H
30	QCD1030	QCD2030	QCD3030H
40	QCD1040	QCD2040	QCD3040H
50	QCD1050	QCD2050	QCD3050H
60	QCD1060	QCD2060	QCD3060H
70	—	QCD2070	QCD3070H
100	—	QCD2100	QCD3100H

QUICKLAG Type QC Miniature Circuit Breakers—Cable-In/Cable-Out 1/2-Inch Wide Types QCR, QCF



Features

When Space is at a Premium

- QCR: For DIN rail mount cable-in/cable-out applications
- QCF: For front-mount through-the-door cable-in/cable-out applications
- 1/2 in (12.7 mm) wide per pole
- Three-position handle: ON, tripped (center), OFF
- Thermal-magnetic protection
- Single-, two- and three-pole
- 10 kAIC at 120/240 Vac, 10–60A
- 10 kAIC at 240 Vac, 10–30A

Catalog Number Selection

QUICKLAG Type QC Miniature Circuit Breakers—Cable-In/Cable-Out 1/2-Inch Wide Types QCR, QCF

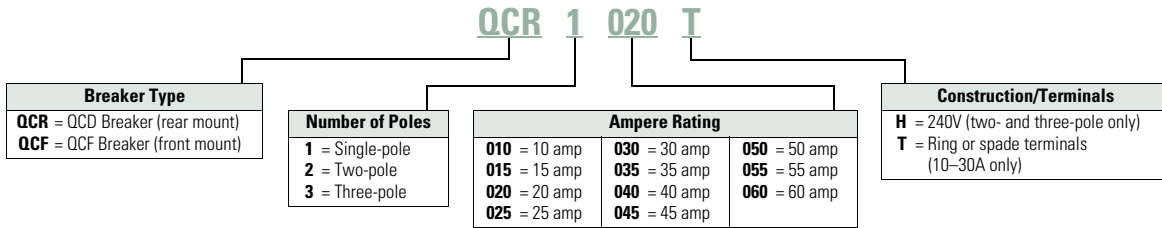

Product Selection

QUICKLAG Type QCR Breakers 10 kAIC Interrupting Ratings ①②③④

Continuous Ampere Rating at 40°C	Single-Pole 120/240 Vac Catalog Number	Two-Pole 120/240 Vac Catalog Number	Three-Pole 240 Vac Catalog Number
10	QCR1010 QCR1010T	QCR2010 QCR2010T	—
15	QCR1015 ⑤ QCR1015T ⑤	QCR2015 QCR2015T	QCR3015H QCR3015HT
20	QCR1020 ⑤ QCR1020T ⑤	QCR2020 QCR2020T	QCR3020H QCR3020HT
25	QCR1025 —	QCR2025 —	QCR3025H QCR3025HT
30	QCR1030 —	QCR2030 —	QCR3030H QCR3030HT
35	QCR1035	QCR2035	—
40	QCR1040	QCR2040	—
45	QCR1045	QCR2045	—
50	QCR1050	QCR2050	—
55	QCR1055	—	—
60 ⑥	QCR1060	QCR2060	—

QUICKLAG Type QCF Breakers 10 kAIC Interrupting Ratings ①②③

Continuous Ampere Rating at 40°C	Single-Pole 120/240 Vac Catalog Number	Two-Pole 120/240 Vac Catalog Number	Three-Pole 240 Vac Catalog Number
10	QCF1010 QCF1010T	QCF2010 QCF2010T	—
15	QCF1015 ⑤ —	QCF2015 —	QCF3015H QCF3015HT
20	QCF1020 ⑤ —	QCF2020 —	QCF3020H QCF3020HT
25	QCF1025 —	QCF2025 —	QCF3025H QCF3025HT
30	QCF1030 —	QCF2030 —	QCF3030H QCF3030HT
40	QCF1040	QCF2040	—
50	QCF1050	QCF2050	—
60 ⑥	QCF1060	QCF2060	—

Notes

- ① Standard breaker terminals are box type lugs.
- ② Breakers with "T" catalog number suffix are suitable for line and load side ring terminal connection (#10-32 plus/minus terminal screw provided).
- ③ Breakers with "P" catalog number suffix are suitable for terminating two 10 AWG quick-connect type terminals per phase on breaker load side.
- ④ Breakers with shunt trip (extra pole required on breaker right-hand side) are available on single-, two- and three-pole.
- ⑤ All 15 and 20A single-pole breakers are SWD (switching duty) rated for fluorescent lighting applications.
- ⑥ 60/75°C Cu/Al wire on all ratings except 60A, which requires Cu only conductor.

Accessories

Type QCR and QCF

Description	Catalog Number
Steel mounting clip mounts QCR breaker if individual mounting is required. Quantity two required for single- and two-pole and four required for three-pole breakers.	QCRMTGFT
Removable padlock device for single-pole QCR or QCF breaker.	QCRFPL1P
Removable padlock device for multi-pole QCR or QCF breaker.	QCRFPLMP
Padlock bracket assembly for QCR or QCF single- or multi-pole breakers (OFF only).	QCRFLOFF
Padlock bracket for QCR, lock-off only.	QCRPLOFF
QUICKLAG Type C Spacer	QCRSPACER

QUICKLAG Type C Spacer



QCR and QCF Ring or Spade Lug Terminals

QCR and QCF ring or spade lug terminals (10–30A ratings only). Factory installed line and load side terminals each equipped with a #10-32 screw suitable for terminating one 10 AWG wire with insulated ring or spade type terminal as shown.

Suffix "T"

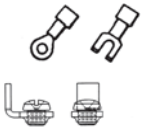

**QUICKLAG Type QC Miniature Circuit Breakers—Cable-In/Cable-Out
1/2-Inch Wide Types QCGF, QCGFEP**



Features

For Cable-In/Cable-Out Panel-Mount Applications

- QUICKLAG ground fault circuit breakers, Class A GFCI:
- Built and tested to UL 943
- 5 mA trip sensitivity
- QUICKLAG ground fault equipment protectors:
 - Built and tested to UL 1053
 - 30 mA trip sensitivity
- All products UL and CSA listed

Catalog Number Selection

**QUICKLAG Type QC Miniature Circuit Breakers—
Cable-In/Cable-Out Ground Fault and Equipment Protector Types QCGF, QCGFEP**

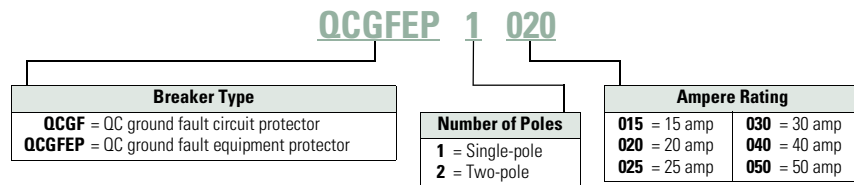



Product Selection

Types QCGF and QCGFEP Thermal-Magnetic Breakers

Continuous Ampere Rating at 40°C	Single-Pole, 120/240 Vac Catalog Number	Two-Pole, 120/240 Vac Catalog Number
Ground Fault Circuit Breakers—5 mA Sensitivity		
QUICKLAG Type: QCGF 10,000 Ampere I.C.		
15	QCGF1015	QCGF2015
20	QCGF1020	QCGF2020
30	QCGF1030	QCGF2030
40	QCGF1040	QCGF2040
50	—	QCGF2050
Ground Fault Equipment Protectors—30 mA Sensitivity		
QUICKLAG Type: QCGFEP 10,000 Ampere I.C.		
15	QCGFEP1015	QCGFEP2015
20	QCGFEP1020	QCGFEP2020
30	QCGFEP1030	QCGFEP2030
40	QCGFEP1040	QCGFEP2040
50	—	QCGFEP2050

Accessories

Type QC Miniature Circuit Breakers

	Accessory ^①	Description	Catalog Number
Handle Locks 	Handle locks: Non-padlockable ^②	QUICKLAG type P, B, C—single-pole	QL1NPL
		QUICKLAG type P, B, C—two-, three-pole	QL23NPL
	Handle locks: Padlockable	QUICKLAG type P, B, C—single-pole	QL1PL
		QUICKLAG type C—single-, two-, three-pole	QC123PL
		QUICKLAG type C—single-, two-, three-pole (off only)	QCD123PLOFF
Handle Tie 	Handle tie	QUICKLAG handle tie—single-pole	QL1HT
		QUICKLAG handle tie—three-pole	QL3HT
Hardware 	Mounting hardware	QUICKLAG type C face mounting clip	QCFLIP
		QUICKLAG type C face mounting plate—single-pole	QC1FP
		QUICKLAG type C face mounting plate—two-pole	QC2FP
		QUICKLAG type C face mounting plate—three-pole	QC3FP
		QUICKLAG type C face mounting plate and lock-off (off only)—two-pole ^③	QC2FPLOFF
		QUICKLAG type C face mounting plate and lock-off (off only)—three-pole	QC3FPLOFF
		QUICKLAG type C base mounting clamp	QCBCLIP
		QUICKLAG base mounting plate—six poles total	QC6BP
		QUICKLAG type C base mounting plate, six-poles total— heavy-duty screw-secured	QC6BPS
		QUICKLAG type C (QCD) two-way jumper unit with cover	QCDJ2
		QUICKLAG type C (QCD) four-way jumper unit with cover	QCDJ4
		QUICKLAG type C (QCD) six-way jumper unit with cover	QCDJ6
		QUICKLAG type C (QCD) two-way jumper unit, no cover	QCDJ2T
		QUICKLAG type C (QCD) four-way jumper unit, no cover	QCDJ4T
		QUICKLAG type C (QCD) six-way jumper unit, no cover	QCDJ6T
		QUICKLAG type QCD finger protection attachment	QCDFP
	QUICKLAG type C DIN rail adapter	QCDINADAPT	

Notes

- ① See **Page V9-T1-22** for QCR and QCF accessories.
- ② Can lock in ON or OFF position.
- ③ Suitable for ground fault breakers.

FAZ-NA UL 489 Circuit Breakers



Features

- UL 489 listed DIN rail mounted miniature circuit breakers up to 40A current rating
- Current limiting design provides fast short-circuit interruption that reduces let-through energy
- Thermal-magnetic overcurrent protection
 - Three levels of short-circuit protection, categorized by B, C and D curves
- Ring-tongue terminals available
- Complete line of accessories

Catalog Number Selection

FAZ-NA UL 489 Circuit Breakers

FAZ-NA UL 489

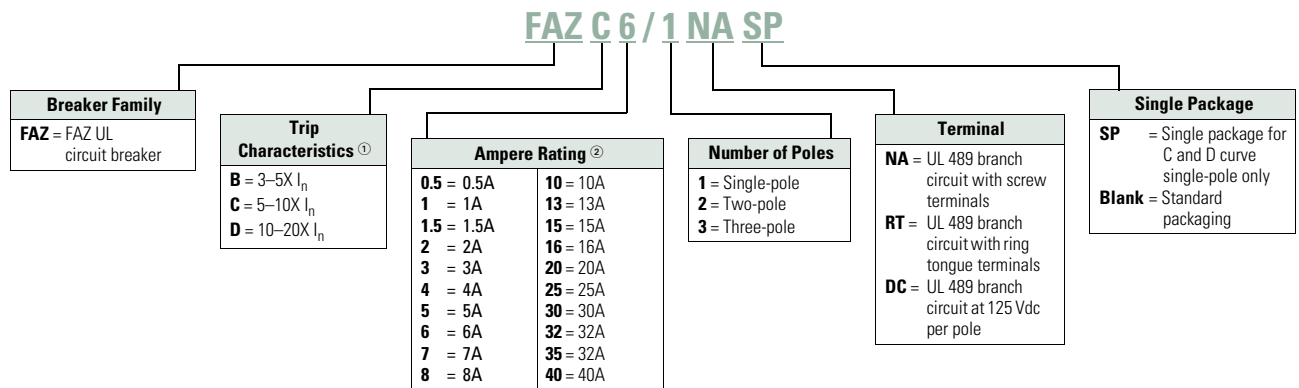

Notes

- ① I_n = Rated current for instantaneous trip characteristics.
- ② B curve starts at 1 ampere.

Product Selection

FAZ-NA UL 489 Circuit Breakers— 10 kAIC, 14 kAIC B Curve (15–25A)

Amperes	Single-Pole ^① Catalog Number	Two-Pole Catalog Number	Three-Pole Catalog Number
B Curve (3–5X I_n Current Rating)			
1	FAZ-B1/1-NA	FAZ-B1/2-NA	FAZ-B1/3-NA
1.5	FAZ-B1.5/1-NA	FAZ-B1.5/2-NA	FAZ-B1.5/3-NA
2	FAZ-B2/1-NA	FAZ-B2/2-NA	FAZ-B2/3-NA
3	FAZ-B3/1-NA	FAZ-B3/2-NA	FAZ-B3/3-NA
4	FAZ-B4/1-NA	FAZ-B4/2-NA	FAZ-B4/3-NA
5	FAZ-B5/1-NA	FAZ-B5/2-NA	FAZ-B5/3-NA
6	FAZ-B6/1-NA	FAZ-B6/2-NA	FAZ-B6/3-NA
7	FAZ-B7/1-NA	FAZ-B7/2-NA	FAZ-B7/3-NA
8	FAZ-B8/1-NA	FAZ-B8/2-NA	FAZ-B8/3-NA
10	FAZ-B10/1-NA	FAZ-B10/2-NA	FAZ-B10/3-NA
13	FAZ-B13/1-NA	FAZ-B13/2-NA	FAZ-B13/3-NA
15	FAZ-B15/1-NA	FAZ-B15/2-NA	FAZ-B15/3-NA
16	FAZ-B16/1-NA	FAZ-B16/2-NA	FAZ-B16/3-NA
20	FAZ-B20/1-NA	FAZ-B20/2-NA	FAZ-B20/3-NA
25	FAZ-B25/1-NA	FAZ-B25/2-NA	FAZ-B25/3-NA
30	FAZ-B30/1-NA	FAZ-B30/2-NA	FAZ-B30/3-NA
32	FAZ-B32/1-NA	FAZ-B32/2-NA	FAZ-B32/3-NA
35 ^②	FAZ-B35/1-NA	FAZ-B35/2-NA	FAZ-B35/3-NA
40 ^②	FAZ-B40/1-NA	FAZ-B40/2-NA	FAZ-B40/3-NA

FAZ-RT UL 489 Circuit Breakers with Ring-Tongue Terminals— 10 kAIC, 14 kAIC B Curve (15–25A)

Amperes	Single-Pole ^① Catalog Number	Two-Pole Catalog Number	Three-Pole Catalog Number
B Curve with Ring-Tongue Terminals (3–5X I_n Current Rating)			
1	FAZ-B1/1-RT	FAZ-B1/2-RT	FAZ-B1/3-RT
1.5	FAZ-B1.5/1-RT	FAZ-B1.5/2-RT	FAZ-B1.5/3-RT
2	FAZ-B2/1-RT	FAZ-B2/2-RT	FAZ-B2/3-RT
3	FAZ-B3/1-RT	FAZ-B3/2-RT	FAZ-B3/3-RT
4	FAZ-B4/1-RT	FAZ-B4/2-RT	FAZ-B4/3-RT
5	FAZ-B5/1-RT	FAZ-B5/2-RT	FAZ-B5/3-RT
6	FAZ-B6/1-RT	FAZ-B6/2-RT	FAZ-B6/3-RT
7	FAZ-B7/1-RT	FAZ-B7/2-RT	FAZ-B7/3-RT
8	FAZ-B8/1-RT	FAZ-B8/2-RT	FAZ-B8/3-RT
10	FAZ-B10/1-RT	FAZ-B10/2-RT	FAZ-B10/3-RT
13	FAZ-B13/1-RT	FAZ-B13/2-RT	FAZ-B13/3-RT
15	FAZ-B15/1-RT	FAZ-B15/2-RT	FAZ-B15/3-RT
16	FAZ-B16/1-RT	FAZ-B16/2-RT	FAZ-B16/3-RT
20	FAZ-B20/1-RT	FAZ-B20/2-RT	FAZ-B20/3-RT
25	FAZ-B25/1-RT	FAZ-B25/2-RT	FAZ-B25/3-RT
30	FAZ-B30/1-RT	FAZ-B30/2-RT	FAZ-B30/3-RT
32	FAZ-B32/1-RT	FAZ-B32/2-RT	FAZ-B32/3-RT
35 ^②	FAZ-B35/1-RT	FAZ-B35/2-RT	FAZ-B35/3-RT
40 ^②	FAZ-B40/1-RT	FAZ-B40/2-RT	FAZ-B40/3-RT

FAZ-NA UL 489 Circuit Breakers— 10 kAIC, 14 kAIC C Curve (15–25A)

Amperes	Single-Pole ^③ Catalog Number	Two-Pole Catalog Number	Three-Pole Catalog Number
C Curve (5–10X I_n Current Rating)			
0.5	FAZ-C0.5/1-NA-SP	FAZ-C0.5/2-NA	FAZ-C0.5/3-NA
1	FAZ-C1/1-NA-SP	FAZ-C1/2-NA	FAZ-C1/3-NA
1.5	FAZ-C1.5/1-NA-SP	FAZ-C1.5/2-NA	FAZ-C1.5/3-NA
2	FAZ-C2/1-NA-SP	FAZ-C2/2-NA	FAZ-C2/3-NA
3	FAZ-C3/1-NA-SP	FAZ-C3/2-NA	FAZ-C3/3-NA
4	FAZ-C4/1-NA-SP	FAZ-C4/2-NA	FAZ-C4/3-NA
5	FAZ-C5/1-NA-SP	FAZ-C5/2-NA	FAZ-C5/3-NA
6	FAZ-C6/1-NA-SP	FAZ-C6/2-NA	FAZ-C6/3-NA
7	FAZ-C7/1-NA-SP	FAZ-C7/2-NA	FAZ-C7/3-NA
8	FAZ-C8/1-NA-SP	FAZ-C8/2-NA	FAZ-C8/3-NA
10	FAZ-C10/1-NA-SP	FAZ-C10/2-NA	FAZ-C10/3-NA
13	FAZ-C13/1-NA-SP	FAZ-C13/2-NA	FAZ-C13/3-NA
15	FAZ-C15/1-NA-SP	FAZ-C15/2-NA	FAZ-C15/3-NA
16	FAZ-C16/1-NA-SP	FAZ-C16/2-NA	FAZ-C16/3-NA
20	FAZ-C20/1-NA-SP	FAZ-C20/2-NA	FAZ-C20/3-NA
25	FAZ-C25/1-NA-SP	FAZ-C25/2-NA	FAZ-C25/3-NA
30	FAZ-C30/1-NA-SP	FAZ-C30/2-NA	FAZ-C30/3-NA
32	FAZ-C32/1-NA-SP	FAZ-C32/2-NA	FAZ-C32/3-NA
35 ^②	FAZ-C35/1-NA-SP	FAZ-C35/2-NA	FAZ-C35/3-NA
40 ^②	FAZ-C40/1-NA-SP	FAZ-C40/2-NA	FAZ-C40/3-NA

FAZ-RT UL 489 Circuit Breakers with Ring-Tongue Terminals— 10 kAIC, 14 kAIC C Curve (15–25A)

Amperes	Single-Pole ^③ Catalog Number	Two-Pole Catalog Number	Three-Pole Catalog Number
C Curve with Ring-Tongue Terminals (5–10X I_n Current Rating)			
0.5	FAZ-C0.5/1-RT-SP	FAZ-C0.5/2-RT	FAZ-C0.5/3-RT
1	FAZ-C1/1-RT-SP	FAZ-C1/2-RT	FAZ-C1/3-RT
1.5	FAZ-C1.5/1-RT-SP	FAZ-C1.5/2-RT	FAZ-C1.5/3-RT
2	FAZ-C2/1-RT-SP	FAZ-C2/2-RT	FAZ-C2/3-RT
3	FAZ-C3/1-RT-SP	FAZ-C3/2-RT	FAZ-C3/3-RT
4	FAZ-C4/1-RT-SP	FAZ-C4/2-RT	FAZ-C4/3-RT
5	FAZ-C5/1-RT-SP	FAZ-C5/2-RT	FAZ-C5/3-RT
6	FAZ-C6/1-RT-SP	FAZ-C6/2-RT	FAZ-C6/3-RT
7	FAZ-C7/1-RT-SP	FAZ-C7/2-RT	FAZ-C7/3-RT
8	FAZ-C8/1-RT-SP	FAZ-C8/2-RT	FAZ-C8/3-RT
10	FAZ-C10/1-RT-SP	FAZ-C10/2-RT	FAZ-C10/3-RT
13	FAZ-C13/1-RT-SP	FAZ-C13/2-RT	FAZ-C13/3-RT
15	FAZ-C15/1-RT-SP	FAZ-C15/2-RT	FAZ-C15/3-RT
16	FAZ-C16/1-RT-SP	FAZ-C16/2-RT	FAZ-C16/3-RT
20	FAZ-C20/1-RT-SP	FAZ-C20/2-RT	FAZ-C20/3-RT
25	FAZ-C25/1-RT-SP	FAZ-C25/2-RT	FAZ-C25/3-RT
30	FAZ-C30/1-RT-SP	FAZ-C30/2-RT	FAZ-C30/3-RT
32	FAZ-C32/1-RT-SP	FAZ-C32/2-RT	FAZ-C32/3-RT
35 ^②	FAZ-C35/1-RT-SP	FAZ-C35/2-RT	FAZ-C35/3-RT
40 ^②	FAZ-C40/1-RT-SP	FAZ-C40/2-RT	FAZ-C40/3-RT

Notes

- ① Two-piece order. Quantities of two per box.
- ② 240 Vac rated only.
- ③ Option for single packaging on single-pole C and D curves only; add suffix SP when ordering.

**FAZ-NA UL 489 Circuit Breakers— 10 kAIC, 14 kAIC
D Curve (13–20A)**

Amperes	Single-Pole ^① Catalog Number	Two-Pole Catalog Number	Three-Pole Catalog Number
D Curve (10–20X I_n Current Rating)			
0.5	FAZ-D0.5/1-NA-SP	FAZ-D0.5/2-NA	FAZ-D0.5/3-NA
1	FAZ-D1/1-NA-SP	FAZ-D1/2-NA	FAZ-D1/3-NA
1.5	FAZ-D1.5/1-NA-SP	FAZ-D1.5/2-NA	FAZ-D1.5/3-NA
2	FAZ-D2/1-NA-SP	FAZ-D2/2-NA	FAZ-D2/3-NA
3	FAZ-D3/1-NA-SP	FAZ-D3/2-NA	FAZ-D3/3-NA
4	FAZ-D4/1-NA-SP	FAZ-D4/2-NA	FAZ-D4/3-NA
5	FAZ-D5/1-NA-SP	FAZ-D5/2-NA	FAZ-D5/3-NA
6	FAZ-D6/1-NA-SP	FAZ-D6/2-NA	FAZ-D6/3-NA
7	FAZ-D7/1-NA-SP	FAZ-D7/2-NA	FAZ-D7/3-NA
8	FAZ-D8/1-NA-SP	FAZ-D8/2-NA	FAZ-D8/3-NA
10	FAZ-D10/1-NA-SP	FAZ-D10/2-NA	FAZ-D10/3-NA
13	FAZ-D13/1-NA-SP	FAZ-D13/2-NA	FAZ-D13/3-NA
15	FAZ-D15/1-NA-SP	FAZ-D15/2-NA	FAZ-D15/3-NA
16	FAZ-D16/1-NA-SP	FAZ-D16/2-NA	FAZ-D16/3-NA
20	FAZ-D20/1-NA-SP	FAZ-D20/2-NA	FAZ-D20/3-NA
25	FAZ-D25/1-NA-SP	FAZ-D25/2-NA	FAZ-D25/3-NA
30	FAZ-D30/1-NA-SP	FAZ-D30/2-NA	FAZ-D30/3-NA
32	FAZ-D32/1-NA-SP	FAZ-D32/2-NA	FAZ-D32/3-NA
35 ^②	FAZ-D35/1-NA-SP	FAZ-D35/2-NA	FAZ-D35/3-NA
40 ^②	FAZ-D40/1-NA-SP	FAZ-D40/2-NA	FAZ-D40/3-NA

**FAZ-NA-DC UL 489 Circuit Breakers— 10 kAIC at
125 Vdc Per Pole**

Amperes	Single-Pole ^③ Catalog Number	Two-Pole Catalog Number
C Curve (5–10X I_n Current Rating)		
2	FAZ-C2/1-NA-DC-SP	FAZ-C2/2-NA-DC
3	FAZ-C3/1-NA-DC-SP	FAZ-C3/2-NA-DC
4	FAZ-C4/1-NA-DC-SP	FAZ-C4/2-NA-DC
5	FAZ-C5/1-NA-DC-SP	FAZ-C5/2-NA-DC
6	FAZ-C6/1-NA-DC-SP	FAZ-C6/2-NA-DC
7	FAZ-C7/1-NA-DC-SP	FAZ-C7/2-NA-DC
8	FAZ-C8/1-NA-DC-SP	FAZ-C8/2-NA-DC
10	FAZ-C10/1-NA-DC-SP	FAZ-C10/2-NA-DC
13	FAZ-C13/1-NA-DC-SP	FAZ-C13/2-NA-DC
15	FAZ-C15/1-NA-DC-SP	FAZ-C15/2-NA-DC
16	FAZ-C16/1-NA-DC-SP	FAZ-C16/2-NA-DC
20	FAZ-C20/1-NA-DC-SP	FAZ-C20/2-NA-DC
25	FAZ-C25/1-NA-DC-SP	FAZ-C25/2-NA-DC
30	FAZ-C30/1-NA-DC-SP	FAZ-C30/2-NA-DC
32	FAZ-C32/1-NA-DC-SP	FAZ-C32/2-NA-DC
35	FAZ-C35/1-NA-DC-SP	FAZ-C35/2-NA-DC
40	FAZ-C40/1-NA-DC-SP	FAZ-C40/2-NA-DC

Notes

- ① Option for single packaging on single-pole C and D curves only; add suffix SP when ordering.
- ② 240 Vac rated only.
- ③ Option for single packaging on single-pole C curves only; add suffix SP when ordering.

**FAZ-RT UL 489 Circuit Breakers with Ring-Tongue
Terminals— 10 kAIC, 14 kAIC D Curve (13–20A)**

Amperes	Single-Pole ^① Catalog Number	Two-Pole Catalog Number	Three-Pole Catalog Number
D Curve with Ring-Tongue Terminals (10–20X I_n Current Rating)			
0.5	FAZ-D0.5/1-RT-SP	FAZ-D0.5/2-RT	FAZ-D0.5/3-RT
1	FAZ-D1/1-RT-SP	FAZ-D1/2-RT	FAZ-D1/3-RT
1.5	FAZ-D1.5/1-RT-SP	FAZ-D1.5/2-RT	FAZ-D1.5/3-RT
2	FAZ-D2/1-RT-SP	FAZ-D2/2-RT	FAZ-D2/3-RT
3	FAZ-D3/1-RT-SP	FAZ-D3/2-RT	FAZ-D3/3-RT
4	FAZ-D4/1-RT-SP	FAZ-D4/2-RT	FAZ-D4/3-RT
5	FAZ-D5/1-RT-SP	FAZ-D5/2-RT	FAZ-D5/3-RT
6	FAZ-D6/1-RT-SP	FAZ-D6/2-RT	FAZ-D6/3-RT
7	FAZ-D7/1-RT-SP	FAZ-D7/2-RT	FAZ-D7/3-RT
8	FAZ-D8/1-RT-SP	FAZ-D8/2-RT	FAZ-D8/3-RT
10	FAZ-D10/1-RT-SP	FAZ-D10/2-RT	FAZ-D10/3-RT
13	FAZ-D13/1-RT-SP	FAZ-D13/2-RT	FAZ-D13/3-RT
15	FAZ-D15/1-RT-SP	FAZ-D15/2-RT	FAZ-D15/3-RT
16	FAZ-D16/1-RT-SP	FAZ-D16/2-RT	FAZ-D16/3-RT
20	FAZ-D20/1-RT-SP	FAZ-D20/2-RT	FAZ-D20/3-RT
25	FAZ-D25/1-RT-SP	FAZ-D25/2-RT	FAZ-D25/3-RT
30	FAZ-D30/1-RT-SP	FAZ-D30/2-RT	FAZ-D30/3-RT
32	FAZ-D32/1-RT-SP	FAZ-D32/2-RT	FAZ-D32/3-RT
35 ^②	FAZ-D35/1-RT-SP	FAZ-D35/2-RT	FAZ-D35/3-RT
40 ^②	FAZ-D40/1-RT-SP	FAZ-C40/2-RT	FAZ-D40/3-RT

1.1

Circuit Protection

Circuit Breakers

1

FAZ UL 1077 Circuit Breakers



Features

- UL 1077 recognized DIN rail mounted supplemental protectors up to 63A
- Current limiting design provides fast short-circuit interruption that reduces let-through energy
- Thermal-magnetic overcurrent protection
 - Three levels of short-circuit protection, categorized by B, C and D curves
- Ideal replacement for fuses that are applied as supplemental protection
- Complete line of accessories

Catalog Number Selection

FAZ UL 1077 Circuit Breakers

FAZ UL 1077

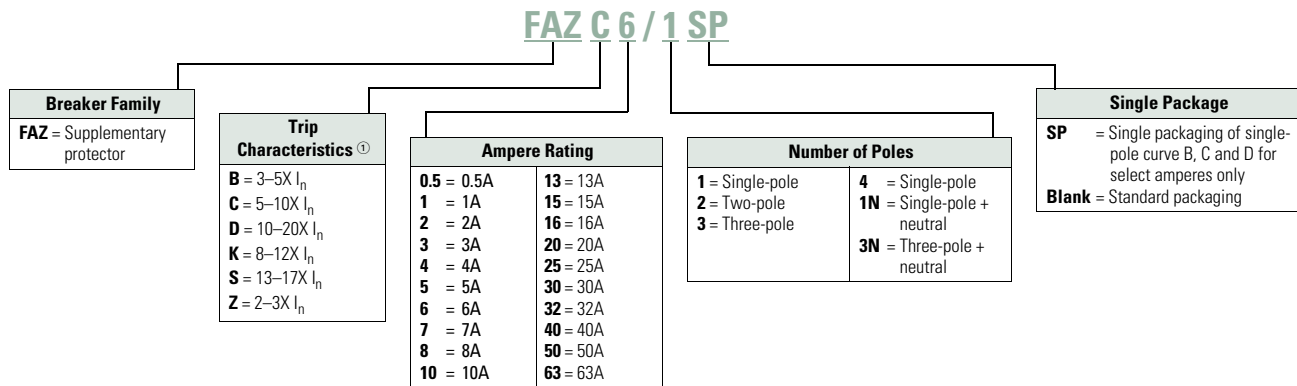

Note

① I_n = Rated current for instantaneous trip characteristics.

Product Selection

B Curve (3–5X I_n Current Rating)—Designed for Resistive or Slightly Inductive Loads ^①

Amperes	Single-Pole ^② Catalog Number	Two-Pole Catalog Number	Three-Pole Catalog Number
1	FAZ-B1/1-SP	FAZ-B1/2	FAZ-B1/3
2	FAZ-B2/1-SP	FAZ-B2/2	FAZ-B2/3
3	FAZ-B3/1-SP	FAZ-B3/2	FAZ-B3/3
4	FAZ-B4/1-SP	FAZ-B4/2	FAZ-B4/3
5	FAZ-B5/1-SP	FAZ-B5/2	FAZ-B5/3
6	FAZ-B6/1-SP	FAZ-B6/2	FAZ-B6/3
7	FAZ-B7/1-SP	FAZ-B7/2	FAZ-B7/3
8	FAZ-B8/1-SP	FAZ-B8/2	FAZ-B8/3
10	FAZ-B10/1-SP	FAZ-B10/2	FAZ-B10/3
12	FAZ-B12/1-SP	FAZ-B12/2	FAZ-B12/3
13	FAZ-B13/1-SP	FAZ-B13/2	FAZ-B13/3
15	FAZ-B15/1-SP	FAZ-B15/2	FAZ-B15/3
16	FAZ-B16/1-SP	FAZ-B16/2	FAZ-B16/3
20	FAZ-B20/1-SP	FAZ-B20/2	FAZ-B20/3
25	FAZ-B25/1-SP	FAZ-B25/2	FAZ-B25/3
30	FAZ-B30/1-SP	FAZ-B30/2	FAZ-B30/3
32	FAZ-B32/1-SP	FAZ-B32/2	FAZ-B32/3
40	FAZ-B40/1-SP	FAZ-B40/2	FAZ-B40/3
50	FAZ-B50/1-SP	FAZ-B50/2	FAZ-B50/3
63	FAZ-B63/1-SP	FAZ-B63/2	FAZ-B63/3

B Curve (3–5X I_n Current Rating)—Designed for Resistive or Slightly Inductive Loads, continued ^①

Amperes	Four-Pole	Single-Pole + Neutral	Three-Pole + Neutral
1	FAZ-B1/4	FAZ-B1/1N	FAZ-B1/3N
2	FAZ-B2/4	FAZ-B2/1N	FAZ-B2/3N
3	FAZ-B3/4	FAZ-B3/1N	FAZ-B3/3N
4	FAZ-B4/4	FAZ-B4/1N	FAZ-B4/3N
5	FAZ-B5/4	FAZ-B5/1N	FAZ-B5/3N
6	FAZ-B6/4	FAZ-B6/1N	FAZ-B6/3N
7	FAZ-B7/4	FAZ-B7/1N	FAZ-B7/3N
8	FAZ-B8/4	FAZ-B8/1N	FAZ-B8/3N
10	FAZ-B10/4	FAZ-B10/1N	FAZ-B10/3N
12	FAZ-B12/4	FAZ-B12/1N	FAZ-B12/3N
13	FAZ-B13/4	FAZ-B13/1N	FAZ-B13/3N
15	FAZ-B15/4	FAZ-B15/1N	FAZ-B15/3N
16	FAZ-B16/4	FAZ-B16/1N	FAZ-B16/3N
20	FAZ-B20/4	FAZ-B20/1N	FAZ-B20/3N
25	FAZ-B25/4	FAZ-B25/1N	FAZ-B25/3N
30	FAZ-B30/4	FAZ-B30/1N	FAZ-B30/3N
32	FAZ-B32/4	FAZ-B32/1N	FAZ-B32/3N
40	FAZ-B40/4	FAZ-B40/1N	FAZ-B40/3N
50	FAZ-B50/4	FAZ-B50/1N	FAZ-B50/3N
63	FAZ-B63/4	FAZ-B63/1N	FAZ-B63/3N

Notes

- ^① In North America, these switches are UL recognized and CSA Certified as supplementary protection devices. Per the intent of NEC (National Electrical Code), Article 240, and CEC (Canadian Electrical Code), Part 1 C22.1, supplementary breakers cannot be used as a substitute for the branch circuit protective device. They can be used to provide overcurrent protection within an appliance or other electrical equipment where branch circuit overcurrent protection is already provided, or is not required.
- ^② Option for single packaging on single-pole B, C and D curves only; add suffix SP when ordering.

1 C Curve (5–10X I_n Current Rating)—Designed Inductive Loads ^①

Amperes	Single-Pole ^② Catalog Number	Two-Pole Catalog Number	Three-Pole Catalog Number
0.5	FAZ-C0.5/1-SP	FAZ-C0.5/2	FAZ-C0.5/3
1	FAZ-C1/1-SP	FAZ-C1/2	FAZ-C1/3
1.6	FAZ-C1.6/1-SP	FAZ-C1.6/2	FAZ-C1.6/3
2	FAZ-C2/1-SP	FAZ-C2/2	FAZ-C2/3
3	FAZ-C3/1-SP	FAZ-C3/2	FAZ-C3/3
4	FAZ-C4/1-SP	FAZ-C4/2	FAZ-C4/3
5	FAZ-C5/1-SP	FAZ-C5/2	FAZ-C5/3
6	FAZ-C6/1-SP	FAZ-C6/2	FAZ-C6/3
7	FAZ-C7/1-SP	FAZ-C7/2	FAZ-C7/3
8	FAZ-C8/1-SP	FAZ-C8/2	FAZ-C8/3
10	FAZ-C10/1-SP	FAZ-C10/2	FAZ-C10/3
13	FAZ-C13/1-SP	FAZ-C13/2	FAZ-C13/3
15	FAZ-C15/1-SP	FAZ-C15/2	FAZ-C15/3
16	FAZ-C16/1-SP	FAZ-C16/2	FAZ-C16/3
20	FAZ-C20/1-SP	FAZ-C20/2	FAZ-C20/3
25	FAZ-C25/1-SP	FAZ-C25/2	FAZ-C25/3
30	FAZ-C30/1-SP	FAZ-C30/2	FAZ-C30/3
32	FAZ-C32/1-SP	FAZ-C32/2	FAZ-C32/3
40	FAZ-C40/1-SP	FAZ-C40/2	FAZ-C40/3
50	FAZ-C50/1-SP	FAZ-C50/2	FAZ-C50/3
63	FAZ-C63/1-SP	FAZ-C63/2	FAZ-C63/3

C Curve (5–10X I_n Current Rating)—Designed Inductive Loads, continued ^①

Amperes	Four-Pole	Single-Pole + Neutral	Three-Pole + Neutral
0.5	FAZ-C0.5/4	FAZ-C0.5/1N	FAZ-C0.5/3N
1	FAZ-C1/4	FAZ-C1/1N	FAZ-C1/3N
1.6	FAZ-C1.6/4	FAZ-C1.6/1N	FAZ-C1.6/3N
2	FAZ-C2/4	FAZ-C2/1N	FAZ-C2/3N
3	FAZ-C3/4	FAZ-C3/1N	FAZ-C3/3N
4	FAZ-C4/4	FAZ-C4/1N	FAZ-C4/3N
5	FAZ-C5/4	FAZ-C5/1N	FAZ-C5/3N
6	FAZ-C6/4	FAZ-C6/1N	FAZ-C6/3N
7	FAZ-C7/4	FAZ-C7/1N	FAZ-C7/3N
8	FAZ-C8/4	FAZ-C8/1N	FAZ-C8/3N
10	FAZ-C10/4	FAZ-C10/1N	FAZ-C10/3N
13	FAZ-C13/4	FAZ-C13/1N	FAZ-C13/3N
15	FAZ-C15/4	FAZ-C15/1N	FAZ-C15/3N
16	FAZ-C16/4	FAZ-C16/1N	FAZ-C16/3N
20	FAZ-C20/4	FAZ-C20/1N	FAZ-C20/3N
25	FAZ-C25/4	FAZ-C25/1N	FAZ-C25/3N
30	FAZ-C30/4	FAZ-C30/1N	FAZ-C30/3N
32	FAZ-C32/4	FAZ-C32/1N	FAZ-C32/3N
40	FAZ-C40/4	FAZ-C40/1N	FAZ-C40/3N
50	FAZ-C50/4	FAZ-C50/1N	FAZ-C50/3N
63	FAZ-C63/4	FAZ-C63/1N	FAZ-C63/3N

Notes

- ^① In North America, these switches are UL recognized and CSA Certified as supplementary protection devices. Per the intent of NEC (National Electrical Code), Article 240, and CEC (Canadian Electrical Code), Part 1 C22.1, supplementary breakers cannot be used as a substitute for the branch circuit protective device. They can be used to provide overcurrent protection within an appliance or other electrical equipment where branch circuit overcurrent protection is already provided, or is not required.
- ^② Option for single packaging on single-pole B, C and D curves only; add suffix SP when ordering.

D Curve (10–20X I_n Current Rating)—Designed for Inductive Loads ^①

Amperes	Single-Pole ^② Catalog Number	Two-Pole Catalog Number	Three-Pole Catalog Number
0.5	FAZ-D0.5/1-SP	FAZ-D0.5/2	FAZ-D0.5/3
1	FAZ-D1/1-SP	FAZ-D1/2	FAZ-D1/3
2	FAZ-D2/1-SP	FAZ-D2/2	FAZ-D2/3
3	FAZ-D3/1-SP	FAZ-D3/2	FAZ-D3/3
4	FAZ-D4/1-SP	FAZ-D4/2	FAZ-D4/3
5	FAZ-D5/1-SP	FAZ-D5/2	FAZ-D5/3
6	FAZ-D6/1-SP	FAZ-D6/2	FAZ-D6/3
7	FAZ-D7/1-SP	FAZ-D7/2	FAZ-D7/3
8	FAZ-D8/1-SP	FAZ-D8/2	FAZ-D8/3
10	FAZ-D10/1-SP	FAZ-D10/2	FAZ-D10/3
13	FAZ-D13/1-SP	FAZ-D13/2	FAZ-D13/3
15	FAZ-D15/1-SP	FAZ-D15/2	FAZ-D15/3
16	FAZ-D16/1-SP	FAZ-D16/2	FAZ-D16/3
20	FAZ-D20/1-SP	FAZ-D20/2	FAZ-D20/3
25	FAZ-D25/1-SP	FAZ-D25/2	FAZ-D25/3
30	FAZ-D30/1-SP	FAZ-D30/2	FAZ-D30/3
32	FAZ-D32/1-SP	FAZ-D32/2	FAZ-D32/3
40	FAZ-D40/1-SP	FAZ-D40/2	FAZ-D40/3
50 ^③	FAZ-D50/1-SP	FAZ-D50/2	FAZ-D50/3
63 ^③	FAZ-D63/1-SP	FAZ-D63/2	FAZ-D63/3

D Curve (10–20X I_n Current Rating)—Designed for Inductive Loads, continued ^①

Amperes	Four-Pole	Single-Pole + Neutral	Three-Pole + Neutral
0.5	FAZ-D0.5/4	FAZ-D0.5/1N	FAZ-D0.5/3N
1	FAZ-D1/4	FAZ-D1/1N	FAZ-D1/3N
2	FAZ-D2/4	FAZ-D2/1N	FAZ-D2/3N
3	FAZ-D3/4	FAZ-D3/1N	FAZ-D3/3N
4	FAZ-D4/4	FAZ-D4/1N	FAZ-D4/3N
5	FAZ-D5/4	FAZ-D5/1N	FAZ-D5/3N
6	FAZ-D6/4	FAZ-D6/1N	FAZ-D6/3N
7	FAZ-D7/4	FAZ-D7/1N	FAZ-D7/3N
8	FAZ-D8/4	FAZ-D8/1N	FAZ-D8/3N
10	FAZ-D10/4	FAZ-D10/1N	FAZ-D10/3N
13	FAZ-D13/4	FAZ-D13/1N	FAZ-D13/3N
15	FAZ-D15/4	FAZ-D15/1N	FAZ-D15/3N
16	FAZ-D16/4	FAZ-D16/1N	FAZ-D16/3N
20	FAZ-D20/4	FAZ-D20/1N	FAZ-D20/3N
25	FAZ-D25/4	FAZ-D25/1N	FAZ-D25/3N
30	FAZ-D30/4	FAZ-D30/1N	FAZ-D30/3N
32	FAZ-D32/4	FAZ-D32/1N	FAZ-D32/3N
40	FAZ-D40/4	FAZ-D40/1N	FAZ-D40/3N
50 ^③	FAZ-D50/4	FAZ-D50/1N	FAZ-D50/3N
63 ^③	FAZ-D63/4	FAZ-D63/1N	FAZ-D63/3N

Notes

- ^① In North America, these switches are UL recognized and CSA Certified as supplementary protection devices. Per the intent of NEC (National Electrical Code), Article 240, and CEC (Canadian Electrical Code), Part 1 C22.1, supplementary breakers cannot be used as a substitute for the branch circuit protective device. They can be used to provide overcurrent protection within an appliance or other electrical equipment where branch circuit overcurrent protection is already provided, or is not required.
- ^② Option for single packaging on single-pole B, C and D curves only; add suffix SP when ordering.
- ^③ IEC 60947-2 only.

Accessories

FAZ-NA UL 489 Breakers

Description	Catalog Number
Two-pole contact or auxiliary contact/trip indicating contact	Z-NHK ^①
Auxiliary contact	Z-IHK-NA
Shunt trip 110–415 Vac	FAZ-XAA-NA110-415VAC
Shunt trip 12–110 Vac	FAZ-XAA-NA12-110VAC
Padlock hasp	IS/SPE-1TE
Busbar—single-pole, 6 terminals ^{②③④⑤}	Z-SV/UL-16/1P-1TE/6
Busbar—single-pole, 12 terminals ^{②③④⑤}	Z-SV/UL-16/1P-1TE/12
Busbar—single-pole, 18 terminals ^{②③④⑤}	Z-SV/UL-16/1P-1TE/18
Busbar—two-pole, 6 terminals ^{②③④⑤}	Z-SV/UL-16/2P-2TE/6
Busbar—two-pole, 12 terminals ^{②③④⑤}	Z-SV/UL-16/2P-2TE/12
Busbar—two-pole, 18 terminals ^{②③④⑤}	Z-SV/UL-16/2P-2TE/18
Busbar—three-pole, 6 terminals ^{②③④⑤}	Z-SV/UL-16/3P-3TE/6
Busbar—three-pole, 12 terminals ^{②③④⑤}	Z-SV/UL-16/3P-3TE/12
Busbar—three-pole, 18 terminals ^{②③④⑤}	Z-SV/UL-16/3P-3TE/18
Three-pole busbar shroud	ZV-BS-UL
Extension terminal—35 mm ² (2–14 AWG)	Z-EK/35/UL
Bus connector—conductors up to 50 mm ² (~1/0 AWG)	Z-EB/50/UL

FAZ UL 1077 Auxiliary Contacts

Description	Rated Operational Voltage	Catalog Number
Standard Auxiliary Contacts		
1NO/1NC Installs on left side of FAZ or shunt trip Max. one per FAZ (1077) device Switches when FAZ is tripped electrically or manually	230 Vac	FAZ-XHIN11
1 changeover contact Installs on left side of FAZ or shunt trip Max. one per FAZ (1077) device Switches when FAZ is tripped electrically or manually	230 Vac	FAZ-XHINW1
Auxiliary/Trip Indicating Contact		
Small selector screw changes mode Two Form C (changeover) contacts Installs on left side of FAZ or shunt trip Auxiliary contacts switch when FAZ is tripped electrically or manually Trip indicating contact switches only when FAZ is tripped electrically	230 Vac	FAZ-XAM002
Undervoltage Trip		
Prevents FAZ from operating unless voltage is present	115 Vac	FAZ-XUA(115VAC)
Installs on left side of FAZ	230 Vac	FAZ-XUA(230VAC)
Includes test button	400 Vac	FAZ-XUA(400VAC)
Shunt Trip		
Allows remote trip of FAZ Installs on left side of FAZ	12–110 Vac 12–60 Vdc	FAZ-XAA-C-12-110VAC
	110–415 Vac 110–230 Vdc	FAZ-XAA-C-110-415VAC

FAZ UL 1077 Busbar System

Rated Operational Current	Number of Poles per Device	Number of Terminals	Catalog Number ^⑤
Without Auxiliary Contacts			
80A	1	57	BB-UL-18/1P-1M/57
	2	56	BB-UL-18/2P-2M/56
	3	57	BB-UL-18/3P-3M/57
100A	1	57	BB-UL-25/1P-1M/57
	2	56	BB-UL-25/2P-2M/56
	3	57	BB-UL-25/3P-3M/57
Auxiliary/Trip Indicating Contacts			
80A	1	37	BB-UL-18/1P-1.5M/37
	2	46	BB-UL-18/2P+AS-2.5M/46
	3	48	BB-UL-18/3P+AS-3.5M/48
100A	1	37	BB-UL-25/1P-1.5M/37
	2	46	BB-UL-25/2P+AS-2.5M/46
	3	48	BB-UL-25/3P+AS-3.5M/48

Pin Type Incoming Supply Terminals

Description	Catalog Number
Accommodates conductors from 6–35 mm ² /#10–2 AWG 4–5.5 Nm/35–50 lb-in / Two- and three-pole	BB-UL-TEP/35

Pin Type Incoming Supply Terminals—Single-Phase Only

Description	Catalog Number
Accommodates conductors from 6–35 mm ² /#10–2 AWG 4–5.5 Nm/35–50 lb-in	BB-UL-TEPA/35

Protective Accessories

Description	Catalog Number
For covering unused terminals	BB-IP/5
Prevents reactivation of the device during maintenance Holds one padlock	IS/SPE-1TE

Bus Incoming Supply Terminals

Description	Catalog Number
50 mm ² #14–1 AWG 75 Deg wire 115 A/Y, 480V UL 160 A/Y 690V IEC	BB-UL-TE/50

Busbar End Cap

Description	Poles	Catalog Number
Install after cutting busbar	2 and 3	BB-UL-EC/3
Protects end of busbar	1	BB-UL-EC/1

Notes

- ① Voltage of FAZ-NA circuit breaker is limited to 300V with this auxiliary contact installed.
- ② Do not cut commoning link.
- ③ A maximum of three commoning links may be used in conjunction. Each breaker connected to the commoning link must have the same number of poles for proper use.
- ④ Not for use with ring-tongue circuit breakers.
- ⑤ Bus may be center fed for high current capacity.

Series NRX Low Voltage Power Breakers**Series NRX™ Low Voltage Power Breakers****Features**

- Rogowski coil does not saturate like iron core sensors, and one sensor accommodates 200–1600A range. Never change a sensor, and NO CTs are required
- Tension clamp secondary terminals—10A continuous rating at 600V meets UL/CSA/RoHS and UL-94 V0. Mounted directly to fixed breaker or drawout cassette they reduce wiring and provide clean, organized wiring schemes
- Breaker mounted communication modules for INCOM™, Modbus® and PROFIBUS® mount directly to the cassette, reducing the space and room required for communication capability
- With the patent pending simple design of the fold-up cassette, all items in a cassette are replaceable without removing the cassette from the cell
- Plug-and-play accessories—no special tools needed. Accessories come with plug and wires ready to install

Catalog Number Selection

Series NRX Power Breakers (Exclusionary Rules Apply)

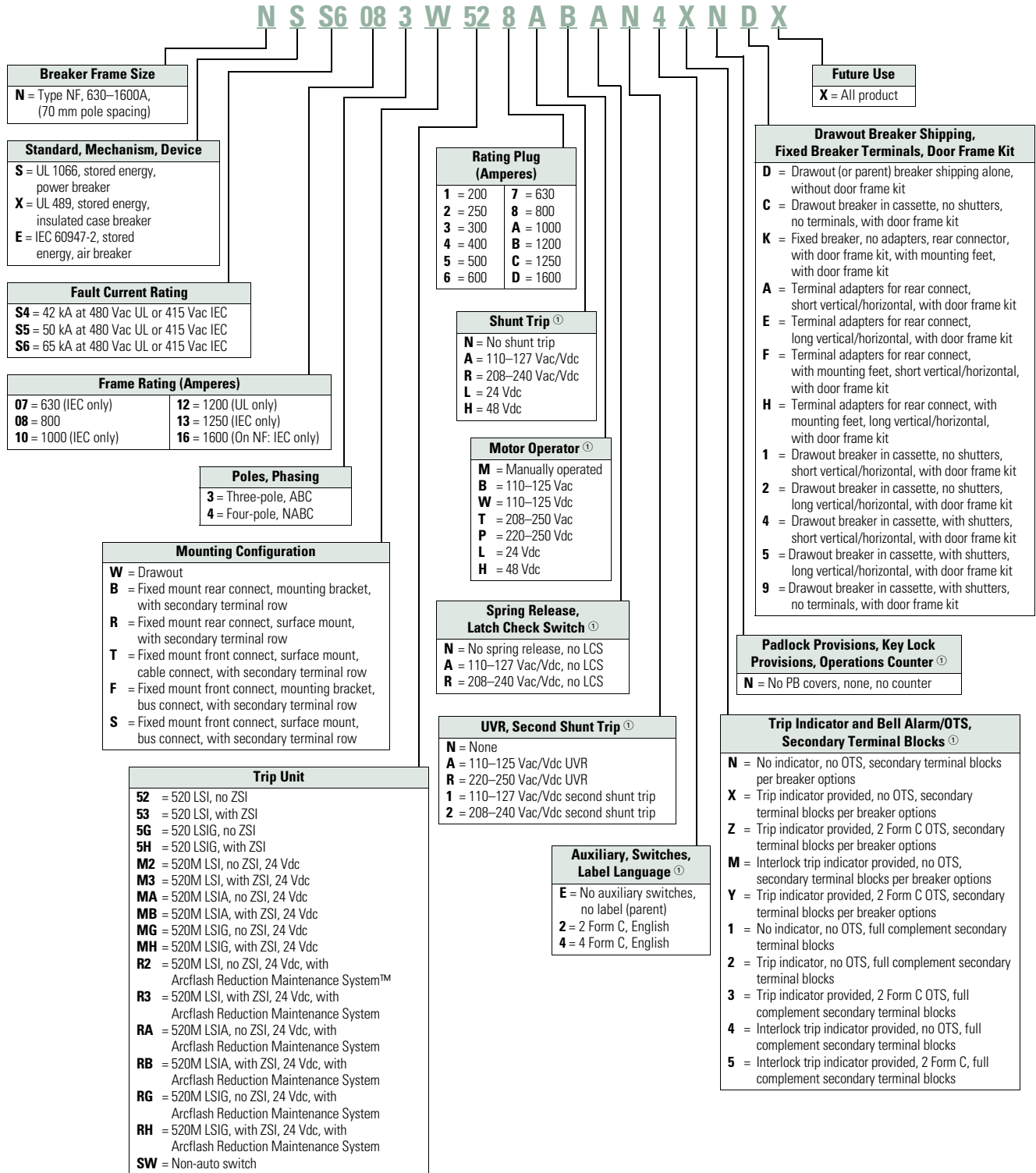

Note
 ① Contact Eaton for available voltages. Not all voltages are currently available.

Catalog Number Selection

Series NRX Cassettes

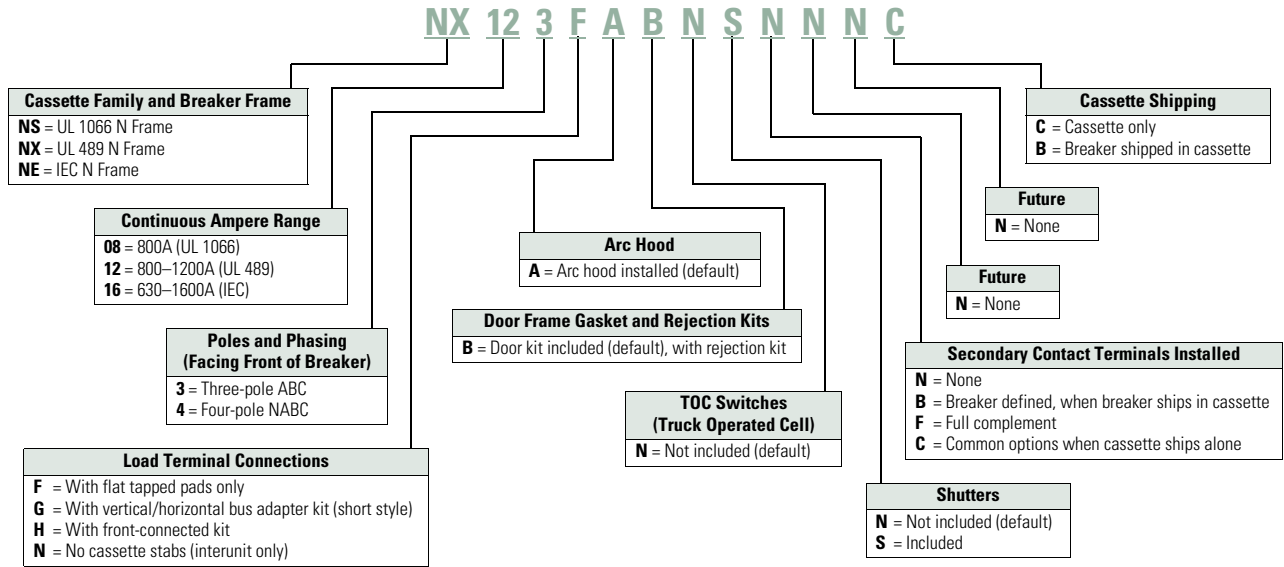

Product Selection

Series NRX Low Voltage Power Breakers

Breaker Frame	Industry Standard	Fault Current Rating (kAIC)	Frame Rating in Amperes	Poles	Mounting	Trip Unit	Rating Plug	Part Number ②
N	UL 1066	42	800	3	Drawout ①	520 LSI (No ZSI)	800	NSS4083W528
N	UL 1066	42	800	4	Fixed	520 LSI (No ZSI)	800	NSS4084B528
N	UL 1066	50	800	3	Drawout ①	520 LSI (No ZSI)	800	NSS5083W528
N	UL 1066	50	800	4	Fixed	520 LSI (No ZSI)	800	NSS5084B528
N	UL 1066	65	800	3	Drawout ①	520 LSI (No ZSI)	800	NSS6083W528
N	UL 1066	65	800	3	Fixed	520 LSI (No ZSI)	800	NSS6083B528
N	UL 1066	65	800	4	Drawout ①	520 LSI (No ZSI)	800	NSS6084W528
N	UL 1066	65	800	4	Fixed	520 LSI (No ZSI)	800	NSS6084B528
N	UL 489	42	800	3	Drawout ①	520 LSI (No ZSI)	800	NXS4083W528
N	UL 489	42	1200	4	Drawout ①	520 LSI (No ZSI)	1200	NXS4124W528
N	UL 489	50	800	3	Fixed	520 LSI (No ZSI)	800	NXS5083B528
N	UL 489	50	1200	4	Fixed	520 LSI (No ZSI)	1200	NXS5124B528
N	UL 489	65	800	3	Drawout ①	520 LSI (No ZSI)	800	NXS6083W528
N	UL 489	65	800	4	Fixed	520 LSI (No ZSI)	800	NSS6084B528
N	UL 489	65	1200	3	Drawout ①	520 LSI (No ZSI)	1200	NXS6123W528
N	UL 489	65	1200	4	Fixed	520 LSI (No ZSI)	1200	NXS6124B528
N	IEC	42	630	3	Drawout ①	520 LSI (No ZSI)	630	NES4073W527
N	IEC	42	1600	4	Drawout ①	520 LSI (No ZSI)	1600	NES4164W52D
N	IEC	50	630	3	Fixed	520 LSI (No ZSI)	630	NES5073B527
N	IEC	50	1600	4	Fixed	520 LSI (No ZSI)	1600	NES5164B52D
N	IEC	65	630	3	Drawout ①	520 LSI (No ZSI)	630	NES6073W527
N	IEC	65	800	4	Fixed	520 LSI (No ZSI)	800	NES6084B528
N	IEC	65	1250	3	Fixed	520 LSI (No ZSI)	1250	NES6133B52C
N	IEC	65	1600	4	Drawout ①	520 LSI (No ZSI)	1600	NES6164W52D

Notes

- ① See Page V9-T1-34 for cassette selection for drawout breakers.
- ② See selection above for accessories in positions 12–20.

Magnum Low Voltage Power Breakers**Features**

- Rated up to 6300A with interrupting ratings up to 200 kAIC and withstand ratings up to 100 kAIC
- Magnum® DS is UL 1066 listed for one-half second short-time withstand rating, and rated for 30 cycles. It is a switchgear class product to meet UL 1558 switchgear standards
- Magnum SB is a UL 1066 listed product with one-half second short-time withstand rating at three cycles to meet switchboard class product specifications, such as UL 891
- Magnum DS MDDX is the highest interrupting performance in a non-current limiting breaker construction rated up to 200 kAIC with 100 kAIC short-time withstand
- The Magnum DS, Magnum SB and Magnum IEC lines all offer the smallest double narrow 4000A frame available

Magnum Low Voltage Power Breakers

Catalog Number Selection

Magnum ANSI/UL Low Voltage Power Breakers

MD S 4 12 3 V E A 06 MU A W C H N E H K L A X

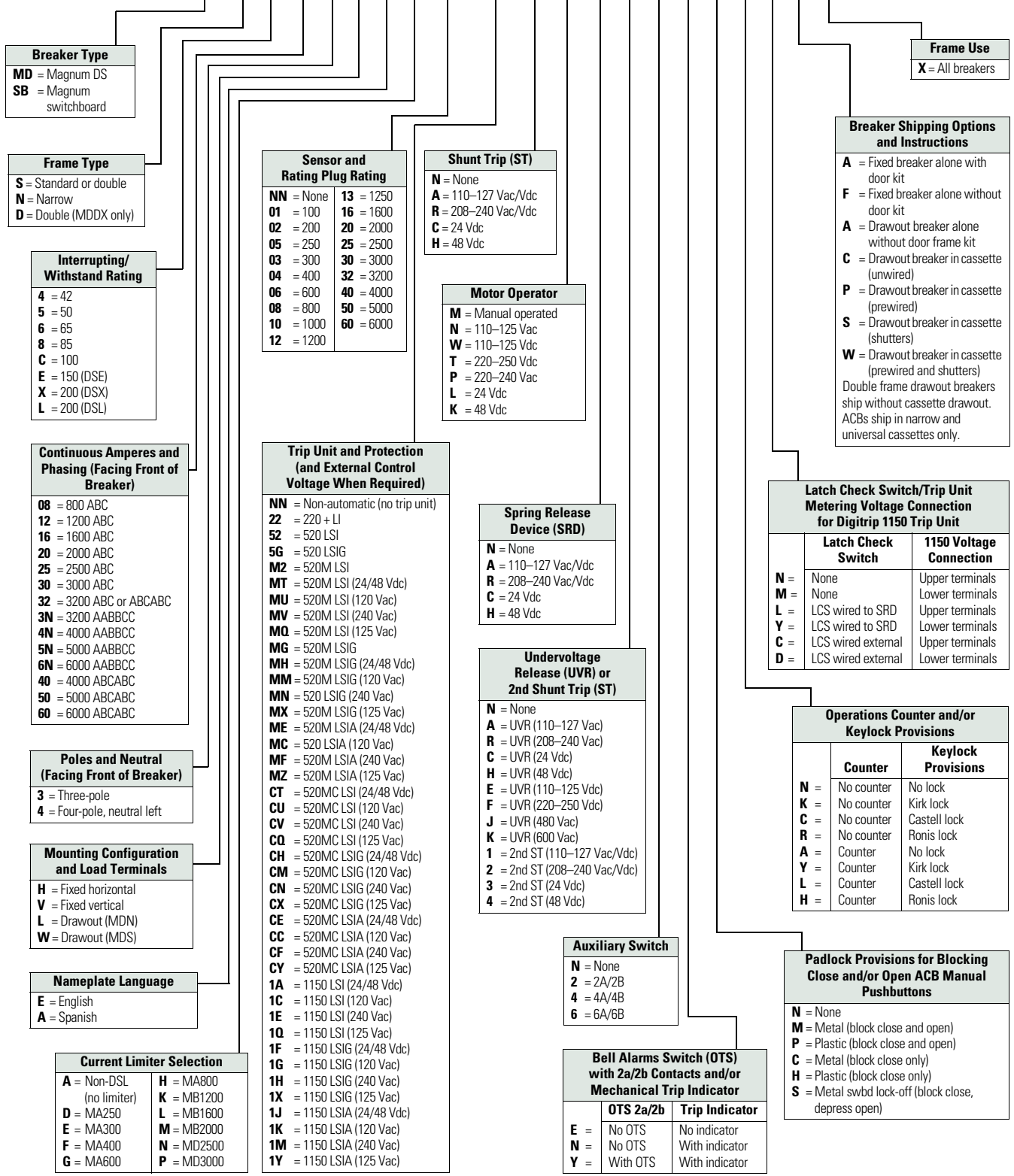

Breaker Type
MD = Magnum DS
SB = Magnum switchboard

Frame Type
S = Standard or double
N = Narrow
D = Double (MDDX only)

Interrupting/Withstand Rating
4 = 42
5 = 50
6 = 65
8 = 85
C = 100
E = 150 (DSE)
X = 200 (DSX)
L = 200 (DSL)

Continuous Amperes and Phasing (Facing Front of Breaker)
08 = 800 ABC
12 = 1200 ABC
16 = 1600 ABC
20 = 2000 ABC
25 = 2500 ABC
30 = 3000 ABC
32 = 3200 ABC or ABCABC
3N = 3200 AABBC
4N = 4000 AABBC
5N = 5000 AABBC
6N = 6000 AABBC
40 = 4000 ABCABC
50 = 5000 ABCABC
60 = 6000 ABCABC

Poles and Neutral (Facing Front of Breaker)
3 = Three-pole
4 = Four-pole, neutral left

Mounting Configuration and Load Terminals
H = Fixed horizontal
V = Fixed vertical
L = Drawout (MDN)
W = Drawout (MDS)

Nameplate Language
E = English
A = Spanish

Current Limiter Selection
A = Non-DSL (no limiter)
D = MA250
E = MA300
F = MA400
G = MA600
H = MA800
K = MB1200
L = MB1600
M = MB2000
N = MD2500
P = MD3000

Sensor and Rating Plug Rating
NN = None
01 = 100
02 = 200
03 = 250
04 = 300
05 = 400
06 = 600
08 = 800
10 = 1000
12 = 1200
13 = 1250
16 = 1600
20 = 2000
25 = 2500
30 = 3000
32 = 3200
40 = 4000
50 = 5000
60 = 6000

Shunt Trip (ST)
N = None
A = 110–127 Vac/Vdc
R = 208–240 Vac/Vdc
C = 24 Vdc
H = 48 Vdc

Motor Operator
M = Manual operated
N = 110–125 Vac
W = 110–125 Vdc
T = 220–250 Vdc
P = 220–240 Vac
L = 24 Vdc
K = 48 Vdc

Trip Unit and Protection (and External Control Voltage When Required)
NN = Non-automatic (no trip unit)
22 = 220 + LI
52 = 520 LSI
5G = 520 LSIG
M2 = 520M LSI
MT = 520M LSI (24/48 Vdc)
MU = 520M LSI (120 Vac)
MV = 520M LSI (240 Vac)
MQ = 520M LSI (125 Vac)
MG = 520M LSIG
MH = 520M LSIG (24/48 Vdc)
MM = 520M LSIG (120 Vac)
MN = 520 LSIG (240 Vac)
MX = 520M LSIG (125 Vac)
ME = 520M LSIA (24/48 Vdc)
MC = 520 LSI (120 Vac)
MF = 520M LSIA (240 Vac)
MZ = 520M LSIA (125 Vac)
CT = 520MC LSI (24/48 Vdc)
CU = 520MC LSI (120 Vac)
CV = 520MC LSI (240 Vac)
CQ = 520MC LSI (125 Vac)
CH = 520MC LSIG (24/48 Vdc)
CM = 520MC LSIG (120 Vac)
CN = 520MC LSI (240 Vac)
CX = 520MC LSI (125 Vac)
CE = 520MC LSIA (24/48 Vdc)
CC = 520MC LSIA (120 Vac)
CF = 520MC LSIA (240 Vac)
CY = 520MC LSIA (125 Vac)
1A = 1150 LSI (24/48 Vdc)
1C = 1150 LSI (120 Vac)
1E = 1150 LSI (240 Vac)
1Q = 1150 LSI (125 Vac)
1F = 1150 LSI (24/48 Vdc)
1G = 1150 LSI (120 Vac)
1H = 1150 LSI (240 Vac)
1X = 1150 LSI (125 Vac)
1J = 1150 LSIA (24/48 Vdc)
1K = 1150 LSIA (120 Vac)
1M = 1150 LSIA (240 Vac)
1Y = 1150 LSIA (125 Vac)

Spring Release Device (SRD)
N = None
A = 110–127 Vac/Vdc
R = 208–240 Vac/Vdc
C = 24 Vdc
H = 48 Vdc

Undervoltage Release (UVR) or 2nd Shunt Trip (ST)
N = None
A = UVR (110–127 Vac)
R = UVR (208–240 Vac)
C = UVR (24 Vdc)
H = UVR (48 Vdc)
E = UVR (110–125 Vdc)
F = UVR (220–250 Vdc)
J = UVR (480 Vac)
K = UVR (600 Vac)
1 = 2nd ST (110–127 Vac/Vdc)
2 = 2nd ST (208–240 Vac/Vdc)
3 = 2nd ST (24 Vdc)
4 = 2nd ST (48 Vdc)

Auxiliary Switch
N = None
2 = 2A/2B
4 = 4A/4B
6 = 6A/6B

Bell Alarms Switch (OTS) with 2a/2b Contacts and/or Mechanical Trip Indicator

	OTS 2a/2b	Trip Indicator
E	No OTS	No indicator
N	No OTS	With indicator
Y	With OTS	With indicator

Frame Use
X = All breakers

Breaker Shipping Options and Instructions
A = Fixed breaker alone with door kit
F = Fixed breaker alone without door kit
A = Drawout breaker alone without door frame kit
C = Drawout breaker in cassette (unwired)
P = Drawout breaker in cassette (prewired)
S = Drawout breaker in cassette (shutters)
W = Drawout breaker in cassette (prewired and shutters)
 Double frame drawout breakers ship without cassette drawout. ACBs ship in narrow and universal cassettes only.

Latch Check Switch/Trip Unit Metering Voltage Connection for Digitrip 1150 Trip Unit

	Latch Check Switch	1150 Voltage Connection
N	None	Upper terminals
M	None	Lower terminals
L	LCS wired to SRD	Upper terminals
Y	LCS wired to SRD	Lower terminals
C	LCS wired external	Upper terminals
D	LCS wired external	Lower terminals

Operations Counter and/or Keylock Provisions

	Counter	Keylock Provisions
N	No counter	No lock
K	No counter	Kirk lock
C	No counter	Castell lock
R	No counter	Ronis lock
A	Counter	No lock
Y	Counter	Kirk lock
L	Counter	Castell lock
H	Counter	Ronis lock

Padlock Provisions for Blocking Close and/or Open ACB Manual Pushbuttons
N = None
M = Metal (block close and open)
P = Plastic (block close and open)
C = Metal (block close only)
H = Plastic (block close only)
S = Metal swbd lock-off (block close, depress open)

1.1

Circuit Protection

Circuit Breakers

1 Magnum ANSI/UL Low Voltage Air Circuit Breaker Cassettes

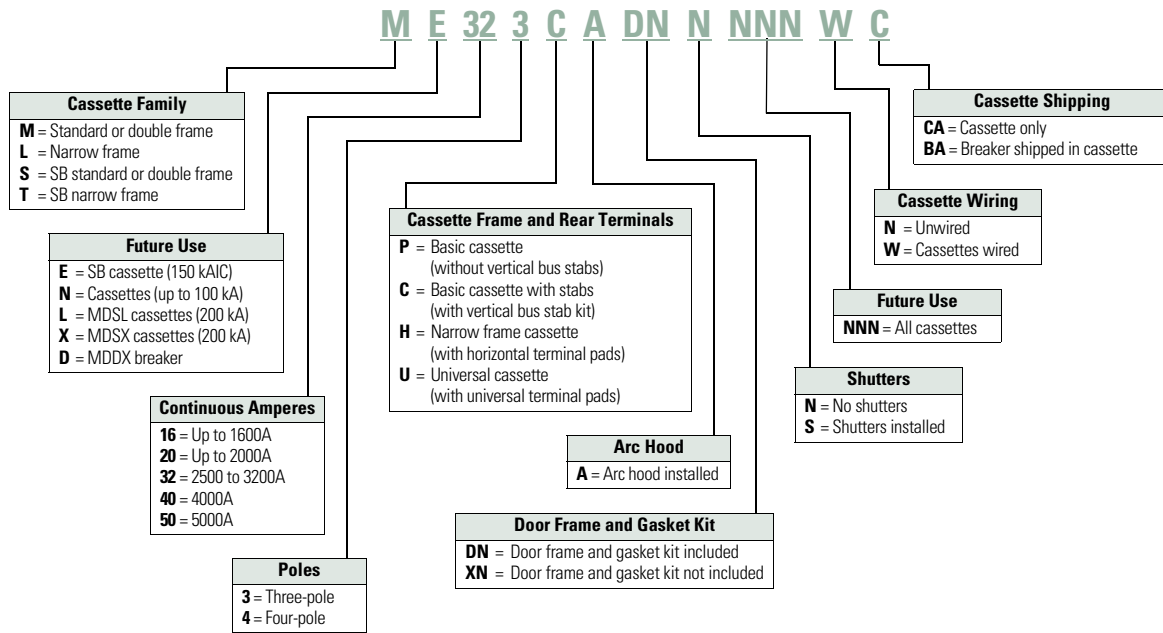

Magnum IEC Low Voltage Air Circuit Breakers

MW I 4 08 3 H E A - 02 22 A M A A 2 E M K L A X

Breaker Frame

I = Standard or double
N = Narrow
K = Special 1100 Vac ACB

Interrupting I_{CU}

4 = 40 kA
5 = 50 kA
6 = 65 kA
8 = 85 kA
C = 100 kA
2 = 25 kA (1100 Vac MWK)

Continuous Amperes and Phasing (Facing Front of Breaker)

08 = 800 ABC
10 = 1000 ABC
12 = 1250 ABC
16 = 1600 ABC
20 = 2000 ABC
25 = 2500 ABC
32 = 3200 ABC
4N = 4000 AABBC
5N = 5000 AABBC
6N = 6300 AABBC
40 = 4000 ABCABC
50 = 5000 ABCABC
60 = 6300 ABCABC

Poles and Neutral (Facing Front of Breaker)

3 = Three
4 = Four (neutral left)
R = Four (reserved for neutral right)

Mounting Configuration and Load Terminals

H = Fixed horizontal
V = Fixed vertical
L = Drawout horizontal

Nameplate Language

E = English
A = Spanish

Sensor and Rating Plug Rating

NN = None	13 = 1250
02 = 200	16 = 1600
05 = 250	20 = 2000
03 = 300	25 = 2500
04 = 400	30 = 3000
06 = 600	32 = 3200
07 = 630	40 = 4000
08 = 800	50 = 5000
10 = 1000	63 = 6300
12 = 1200	

Trip Unit Protection, (and External Control Voltage When Required)

NN = Non-automatic (no trip unit)
22 = 220 LI
52 = 520 LSI
5W = 520i LSIG
M2 = 520M LSI
MT = 520M LSI (24–48 Vdc)
MU = 520M LSI (120 Vac)
MV = 520M LSI (240 Vac)
MW = 520Mi LSIG
MJ = 520Mi LSIG (24–48 Vdc)
MK = 520Mi LSIG (120 Vac)
ML = 520Mi LSIG (240 Vac)
ME = 520M LSI/A (24–48 Vdc)
MC = 520M LSI/A (120 Vac)
MF = 520M LSI/A (240 Vac)
CT = 520MC LSI
CU = 520MC LSI
CV = 520MC LSI
CE = 520MC LSI/A
CC = 520MC LSI/A
CJ = 520MC LSI/A
CF = 520MCi LSIG
CK = 520MCi LSIG
CL = 520MCi LSIG
1W = 1150i LSI (24–48 Vdc)
1N = 1150i LSI (120 Vac)
1P = 1150i LSI (240 Vac)
1R = 1150i LSI/A (24–48 Vdc)
1S = 1150i LSI/A (120 Vac)
1T = 1150i LSI/A (240 Vac)

Auxiliary Switch

N = None
2 = 2A/2B
4 = 4A/4B
6 = 6A/6B

Shunt Trip Attachment (STA)

N = None
A = 110–127 Vac
R = 208–240 Vac
C = 24 Vdc
H = 48 Vdc

Motor Operator

M = Manual operated
N = 110–125 Vac
W = 110–125 Vdc
T = 220–250 Vdc
P = 220–250 Vac
L = 24 Vdc
K = 48 Vdc

Spring Release Device (SRD)

N = None
A = 110–127 Vac/Vdc
R = 208–240 Vac/Vdc
C = 24 Vdc
H = 48 Vdc

Undervoltage Release (UVR) or 2nd Shunt Trip Attachment (STA)

N = None
A = 110–127 Vac
R = 208–240 Vac
C = 24 Vdc
H = 48 Vdc
E = 110–125 Vdc
F = 220–250 Vdc
G = 32 Vdc
X = 380–415 Vac
J = 480 Vac
K = 600 Vac
1 = 2nd STA (110–127 Vac/Vdc)
2 = 2nd STA (208–250 Vac/Vdc)
3 = 2nd STA (24 Vdc)
4 = 2nd STA (48 Vdc)

Future Use

X = All ACBs

ACB Shipping Instructions

A = Fixed ACB with door kit
F = Fixed ACB without door kit
A = D/O ACB only without door kit
C = D/O ACB in cassette (unwired)
P = D/O ACB in cassette (prewired)
S = D/O ACB in cassette (shutters)
W = D/O ACB in cassette (prewired and shutters)
 Double frame D/O ACBs ship without cassette

Latch Checking Switch/Trip Unit Metering Voltage Connection for Digitrip 1150 Trip Unit

	Latch Check Switch	1150 Voltage Connection
N =	None	Upper terminals
M =	None	Lower terminals
L =	LCS wired to SRD	Upper terminals
Y =	LCS wired to SRD	Lower terminals
C =	LCS wired external	Upper terminals
D =	LCS wired external	Lower terminals

Operations Counter and/or Keylock Provisions

	Counter	Keylock Provisions
N =	No counter	No lock
K =	No counter	Kirk lock
C =	No counter	Castell lock
R =	No counter	Ronis lock
A =	Counter	No lock
T =	Counter	Kirk lock
L =	Counter	Castell lock
H =	Counter	Ronis lock

Padlock Provisions for Blocking Close and/or Open ACB Manual Pushbuttons

N = None
M = Metal (block close and open)
P = Plastic (block close and open)
C = Metal (block close only)
H = Plastic (block close only)

Bell Alarms Switch (OTS) with 2a/2b Contacts and/or Mechanical Trip Indicator

	OTS 2a/2b	Trip Indicator
E =	No OTS	No indicator
N =	No OTS	With indicator
Y =	With OT	With indicator

Product Selection

Magnum DS Switchgear Class UL 1066 Low Voltage Power Circuit Breakers

Frame Type	RMS Symmetrical Current Ratings kA 50/60 Hz ^①			Short Time Current Rating	Frame Amperes	Breaker Type ^②	
	Interrupting at 254 Vac	Interrupting at 508 Vac	Interrupting at 635 Vac				
Narrow	42	42	42	42	800	MDN-408	
	50	50	50	50		MDN-508	
	65	65	65	65		MDN-608	
	100	100	65	20		MDN-C08	
Standard	42	42	42	42	800	MDS-408	
	65	65	65	65		MDS-608	
	85	85	85	85		MDS-808	
	100	100	100	85		MDS-C08	
	200	200	200	—		MDS-L08 ^③	
Narrow	42	42	42	42	1600	MDN-416	
	50	50	50	50		MDN-516	
	65	65	65	65		MDN-616	
	100	100	65	30		MDN-C16	
Standard	65	65	65	65	1600	MDS-616	
	85	85	85	85		MDS-816	
	100	100	100	85		MDS-C16	
	200	200	200	—		MDS-L16 ^③	
	200	200	④	30		MDS-X16 ^⑤	
Narrow	65	65	65	65	2000	MDN-620	
	100	100	65	35		MDN-C20	
Standard	65	65	65	65	2000	MDS-620	
	85	85	85	85		MDS-820	
	100	100	100	85		MDS-C20	
	200	200	200	—		MDS-L20 ^③	
	200	200	④	30		MDS-X20 ^⑤	
	65	65	65	65		3200	MDS-632
85	85	85	85	MDS-832			
100	100	100	85	MDS-C32			
Double	200	200	④	50	3200	MDS-X32 ^⑤	
Double (N)	85	85	④	85	4000	MDN-840	
	100	100	④	100		MDN-C40	
Double	85	85	85	85	4000	MDS-840	
	100	100	100	100		MDS-C40	
	200	200	④	50		MDS-X40 ^⑤	
	200	200	④	100	4000	MDD-X40	
	85	85	85	85		5000	MDS-850
	100	100	100	100			MDS-C50
	200	200	④	50	6000	MDS-X50 ^{⑤⑦}	
	200	200	④	100		MDD-X50	
	100	100	100	100		MDS-C60 ^⑦	
200	200	④	100	MDD-X60			

Notes

- ① Interrupting ratings shown based on breaker equipped with integral Digitrip RMS trip unit. Interruption ratings for non-automatic breakers are equal to the published short time current rating. These interruption ratings are based on the standard duty cycle consisting of an open operation, a 15-second interval and a close-open operation, in succession, with delayed tripping in case of short-delay devices. The standard duty cycle for short time ratings consists of maintaining the rated current for two periods of 1/2 seconds each, with a 15-second interval of zero current between the two periods.
- ② See **Page V9-T1-40** for selection of trip unit and accessories. See **Page V9-T1-40** for cassette selection for drawout breakers.
- ③ Magnum MDSL current limiting power circuit breaker with integral current limiters. Current limiter selected determines short time and maximum instantaneous trip rating. Maximum voltage rating is 600 Vac.
- ④ Product to be tested. Contact Eaton for product rating.
- ⑤ Magnum MDSX current limiting power circuit breaker with fast opening contacts.
- ⑥ Contact Eaton for availability.
- ⑦ Breaker applied in a tested fan-cooled enclosure.

Magnum SB Switchboard Class UL 1066 Insulated Case Low Voltage Power Circuit Breakers

Frame Type	RMS Symmetrical Current Ratings kA 50/60 Hz ^①			Short Time Current Rating	Frame Amperes	Breaker Type ^②
	Interrupting at 254 Vac	Interrupting at 508 Vac	Interrupting at 635 Vac			
Narrow	50	50	35	20	800	SBN-508
	65	65	42	20		SBN-608
	100	100	65	20		SBN-C08
Standard	65	65	65	20	800	SBS-608
	100	100	85	20		SBS-C08
	200	150	②	30		SBS-E08 ^③
Narrow	50	50	35	25	1200	SBN-512
	65	65	42	25		SBN-612
	100	100	65	25		SBN-C12
Standard	65	65	65	25	1200	SBS-612
	100	100	85	25		SBS-C12
	200	150	②	30		SBS-E12 ^③
Narrow	50	50	35	30	1600	SBN-516
	65	65	42	30		SBN-616
	100	100	65	30		SBN-C16
Standard	65	65	65	30	1600	SBS-616
	100	100	85	30		SBS-C16
	200	150	②	30		SBS-E16 ^③
Narrow	65	65	65	35	2000	SBN-620
	100	100	65	35		SBN-C20
Standard	65	65	65	35	2000	SBS-620
	100	100	85	35		SBS-C20
	200	150	②	30		SBS-E20 ^③
Narrow	65	65	65	45	2500	SBS-625
	100	100	85	45		SBS-C25
Double	200	150	②	50		SBS-E25 ^③
Standard	65	65	65	50	3000	SBS-630
	100	100	85	50		SBS-C30
Double	200	150	②	50		SBS-E30 ^③
Double (N)	85	85	③	85	4000	SBN-840
	100	100	③	100		SBN-C40
Double	85	85	85	85	5000	SBS-840
	100	100	100	100		SBS-C40
	200	150	②	50		SBS-E40 ^③
Double	85	85	85	85	5000	SBS-850
	100	100	100	100		SBS-C50
Double	200	150	②	50	6000	SBS-E50 ^{③④}
	100	100	100	100		SBS-C60 ^④

Notes

- ① Interrupting ratings shown based on breaker equipped with integral Digitrip RMS trip unit. Interruption ratings for non-automatic breakers are equal to the published short time current rating. These interruption ratings are based on the standard duty cycle consisting of an open operation, a 15-second interval and a close-open operation, in succession, with delayed tripping in case of short-delay devices. The standard duty cycle for short time ratings consists of maintaining the rated current for two periods of 1/2 seconds each, with a 15-second interval of zero current between the two periods.
- ② Product to be tested. Contact Eaton for product rating.
- ③ Magnum SBSE current limiting power circuit breaker with fast opening contacts.
- ④ Breaker applied in a tested fan-cooled enclosure.

Magnum IEC 60947-2 Rated Low Voltage Air Circuit Breakers

Frame Amperes	Breaker Type	Frame Type	rms Symmetrical Current Ratings kA ^①			Withstand Rating I _{CW} 1-Sec/3-Sec	Fixed Internal Inst. Trip	Available Current Sensor and Rating Plugs for Digitrip RMS Trip Unit (Establishes Breaker I _n Rating)
			Interrupting at 240 Vac I _{CU} = I _{CS}	Interrupting at 440 Vac I _{CU} = I _{CS}	Interrupting at 690 Vac I _{CU} = I _{CS}			
800	MWN-408	Narrow	40	40	40	40/—	—	200, 250, 300, 400, 630, 800
	MWN-508	Narrow	50	50	50	50/—	—	
	MWN-608	Narrow	65	65	65	65/40	—	
	MWI-608	Standard	65	65	65	65/—	—	
	MWI-808	Standard	85	85	85	85/65	—	
	MWI-C08	Standard	100	100	85	85/65	85	
1000	MWN-410	Narrow	40	40	40	40/—	—	200, 250, 300, 400, 630, 800, 1000
	MWN-510	Narrow	50	50	50	50/—	—	
	MWN-610	Narrow	65	65	65	65/40	—	
	MWI-610	Standard	65	65	65	65/—	—	
	MWI-810	Standard	85	85	85	85/65	—	
	MWI-C10	Standard	100	100	85	85/65	85	
1250	MWN-412	Narrow	40	40	40	40/—	—	200, 250, 300, 400, 630, 800, 1000, 1250
	MWN-512	Narrow	50	50	50	50/—	—	
	MWN-612	Narrow	65	65	65	65/40	—	
	MWI-612	Standard	65	65	65	65/—	—	
	MWI-812	Standard	85	85	85	85/65	—	
	MWI-C12	Standard	100	100	85	85/65	85	
1600	MWN-516	Narrow	50	50	50	50/—	—	200, 250, 300, 400, 630, 800, 1000, 1250, 1600
	MWN-616	Narrow	65	65	65	65/40	—	
	MWI-616	Standard	65	65	65	65/—	—	
	MWI-816	Standard	85	85	85	85/65	—	
	MWI-C16	Standard	100	100	85	85/65	85	
2000	MWN-520	Narrow	50	50	50	50/30	—	200, 250, 300, 400, 630, 800, 1000, 1250, 1600, 2000
	MWN-620	Narrow	65	65	65	65/40	—	
	MWI-620	Standard	65	65	65	65/50	—	
	MWI-820	Standard	85	85	85	85/65	—	
	MWI-C20	Standard	100	100	85	85/65	85	
2500	MWI-625	Standard	65	65	65	65/—	—	200, 250, 300, 400, 630, 800, 1000, 1250, 1600, 2000, 2500
	MWI-825	Standard	85	85	85	85/65	—	
	MWI-C25	Standard	100	100	85	85/65	85	
3200	MWI-632	Standard	65	65	65	65/50	—	200, 250, 300, 400, 630, 800, 1000, 1250, 1600, 2000, 2500, 3200
	MWI-832	Standard	85	85	85	85/65	—	
	MWI-C32	Standard	100	100	85	85/65	85	
4000	MWI-64N	Double	65	65	65	65/—	—	2000, 2500, 3200, 4000
	MWI-84N	Double	85	85	85	85/—	—	
	MWI-C4N	Double	100	100	100	100/—	—	
5000	MWI-85N	Double	85	85	85	85/—	—	2500, 3200, 4000, 5000
	MWI-C5N	Double	100	100	100	100/—	—	
6300	MWI-86N	Double	85	85	85	85/—	—	3200, 4000, 5000, 6300
	MWI-C6N	Double	100	100	100	100/—	—	

Note

^① Interrupting ratings shown based on breaker equipped with integral Digitrip RMS trip unit. Interruption ratings for non-automatic breakers are equal to the published breaker I_{CW} rating.

Product Overview**Fuse Blocks and Fuse Holders**

Description	C350 Series
	Page V9-T1-45
Technical Data	
Number of poles	Up to 3
Mounting	35 mm flat or 32 mm asymmetrical DIN rail (with optional adapter)
Terminal ratings	600V, 30A
Housing construction	Thermoplastic UL 94V0 flammability rating
Clip/terminal construction	Tin-plated copper alloy
Screw/pressure plate construction	Zinc-plated steel
Dielectric strength	1200V
Approvals	
	UL, CSA

For our complete product offering, see Volume 4—Circuit Protection, CA08100005E.

C350 Series Fuse Blocks and Fuse Holders



Features

- Space-saving design
- Rated 600V, 30A
- UL approved for motor loads

Product Selection

C350 Series

Fuse Blocks and Fuse Holders

Wire Termination	Number of Poles	250V			600V				
		30A Catalog Number	Carton Qty.	60A Catalog Number	Carton Qty.	30A Catalog Number	Carton Qty.	60A Catalog Number	Carton Qty.
Class H Fuse Holders									
Single collar (box lug)—sized to ampere rating	1	W231HA	10	W261HA	10	W631HA	10	W661HA	1
	2	W232HA	5	W262HA	5	W632HA	5	W662HA	1
	3	W233HA	5	W263HA	5	W633HA	1	W663HA	2
Class M Fuse Holders									
Combination of double quick-connect, 20A max., and binding head screw, #10 max., Cu/Al	1	—	—	—	—	WM631F	10	—	—
	2	—	—	—	—	WM632F	8	—	—
	3	—	—	—	—	WM633F	6	—	—
Combination of double quick-connect, 20A max., and pressure plate screw, #10 max., Cu only	1	—	—	—	—	WM631G	10	—	—
	2	—	—	—	—	WM632G	8	—	—
	3	—	—	—	—	WM633G	6	—	—
Class R Fuse Holders									
Single collar (box lug)—sized to ampere rating	1	WR231HA	10	—	—	WR631HA	10	—	—
	2	—	—	—	—	WR632HA	5	—	—
	3	WR233HA	5	WR263HA	1	WR633HA	5	WR663HA	5
Combination of double quick-connect, 20A max., and binding head screw, #10 max., Cu/Al	1	—	—	—	—	—	—	—	—
	2	—	—	—	—	WMR632F	1	—	—
	3	—	—	—	—	WMR633F	6	—	—
Combination of double quick-connect, 20A max., and pressure plate screw, #10 max., Cu only	1	—	—	—	—	WMR631G	10	—	—
	3	—	—	—	—	WMR633G	6	—	—
Class R Fuse Holder, Type WRR Control Transformer Fuse Block									
Combination of double quick-connect, 20A max., and pressure plate screw, #14–#10 Cu only	3	—	—	—	—	WRR633G	6	—	—

1

Open Rotary Disconnects

Product Overview

Rotary Disconnect Switch Selection Guide



**R5 Series
Non-Fusible 16–80A**



**R9 Series
Non-Fusible 30–100A Compact**



**R9 Series
Non-Fusible 100–1200A**

Description

Page V9-T1-48

Page V9-T1-50

Page V9-T1-52

Product Description

R5 Series (UL 508 listed) products are manually operated modular switches. Load break switching and isolation provide safety solutions for any low voltage circuit, particularly for machine and control circuits. The R5 Series products are manual motor controllers suitable as motor disconnect.

The R9 Series (UL 98 listed) non-fusible 30–100A compact range ensures making or breaking on load and safety isolation for low voltage electrical circuits, particularly for machine control circuits up to 600V.

The R9 Series (UL 98 listed) non-fusible 100–1200A are manually operated multipole load-break switches. Quick-make, quick-break design provides safety isolation for any low voltage circuit.

Approvals

UL 508 listed, Guide NLRV, File E165150
CSA C22.2 No. 14, File 217736
IEC 60947-3, EN 60947-3
CCC

UL 98, File E222859
CSA 22.2 No. 4, File 217736
IEC 60947-3
EN 60947-3

UL 98, File E222859
CSA 22.2 No. 4, File 217736
IEC 60947-3
EN 60947-3



**R9 Series
Fusible 30–800A**



**R9 Series
DC Rated Disconnects**



Manual Transfer Switches

Description

Page V9-T1-54

Page V9-T1-59

Page V9-T1-60

Product Description

R9 Series (UL 98 listed) Fusible 30–800A manual operated multi-pole fusible disconnect switches use double break contacts per pole that ensure complete isolation of the fuse when the switch is in the OFF position.

When installed with fuses, they provide protection for low voltage electrical installations against short circuit and overload.

UL listed disconnect switches 600 Vdc for photovoltaic applications 100 to 400A

R9 Series (UL 98 listed) DC rated disconnects are manually operated multi-pole load break switches. They provide safety isolation for any low voltage circuit in a photovoltaic application.

R9 Series (UL 98 listed) non-fusible disconnects are heavy-duty manual transfer switches, they transfer load manually between two low voltage circuits and provide safety disconnection.

These switches are extremely durable and are tested and approved for use in the most demanding applications as resistive load or total system applications.

Approvals

UL 98, File E222859 for 30 to 800A ratings
UL 489, File E305341 for H Frame switches
CSA 22.2 No. 4, File 217736
CSA 22.2 No. 5, File 217736, H Frame only
IEC 60947-1, EN 60947-1
IEC 60947-3, EN 60947-3
CE mark
NFFPA® 79

UL 98, cULus®, File E222859
CSA 22.2 No. 4, File 217736 ①
IEC 60947-3
EN 60947-3
IEC 60-364-7-712 (Rules for the installations and sites special—photovoltaic applications)

UL 98, cULus, File E222859
UL 1008 (2011)
CSA 22.2 No. 4, File 217736
IEC 60947-3
EN 60947-3

Note
① Q4 2010

Catalog Number Selection

Disconnects

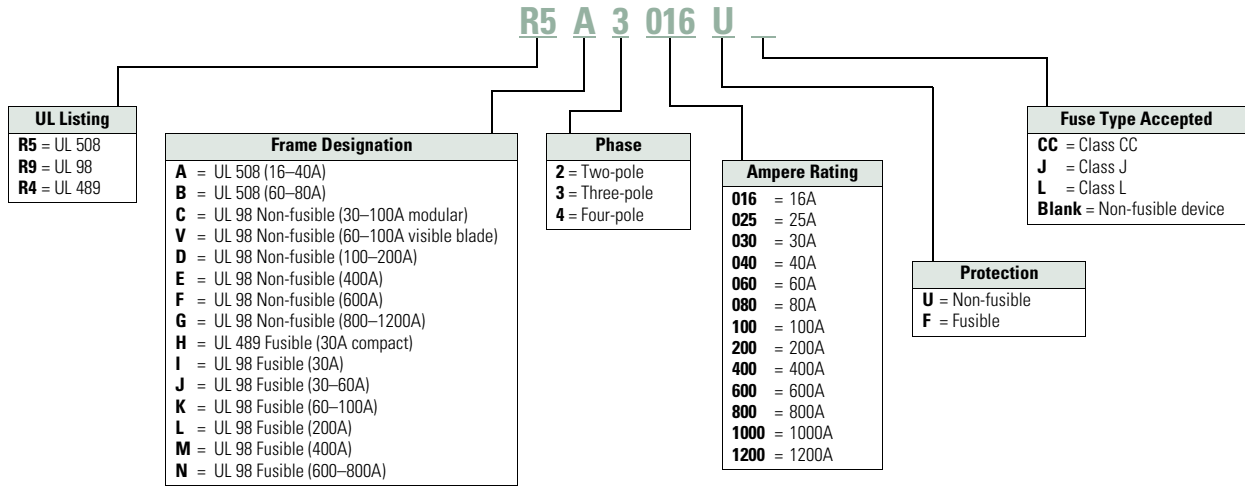

External Handles

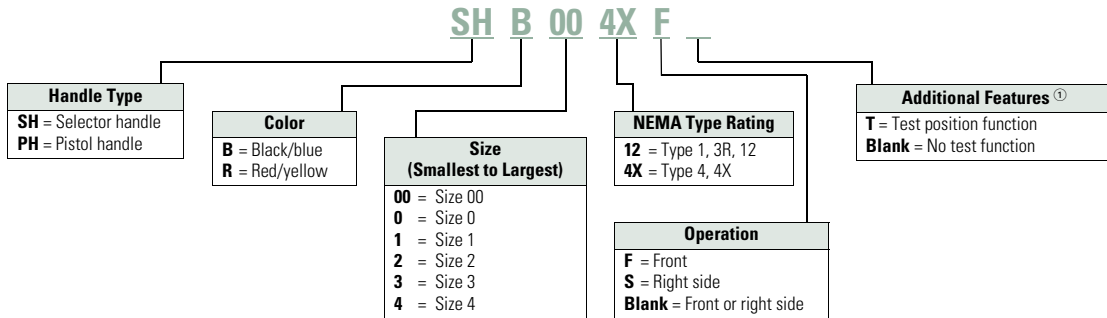

Shafts

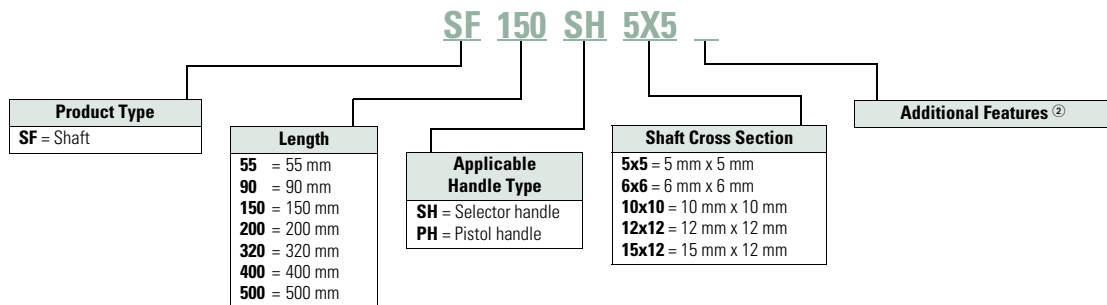

Notes

- ① **HV** at the end of some catalog numbers indicates use with H and V switches only. Not all handles are designed to go with all disconnects. Consult specific section of the catalog for available options.
- ② **H** at the end of some catalog numbers indicates use with H Frame switches only. Not all shafts are designed to go with all disconnects. Consult specific section of the catalog for available options.

1

R5 Series Non-Fusible 16–80A**Features**

- Up to 65 kAIC short-circuit rating
- Direct or external operation
- Compact footprint
- DIN rail or base mount
- Wide range of accessories
- Modular design
- Padlockable design (direct, toggle and external handles)

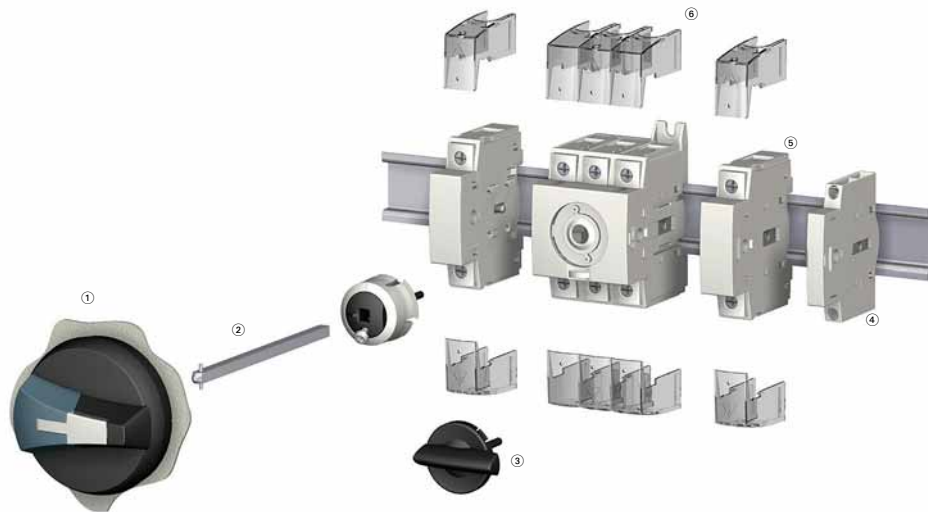
R5 Series Non-Fusible 16–80A**Product Identification**

- ① External front handle
- ② Shaft extension for external handle
- ③ Direct handle
- ④ Auxiliary contacts
- ⑤ Switched fourth-pole module
- ⑥ Terminal shroud

Note: For further details, please see the installation instructions supplied with each device.

Product Selection

Direct Operation



Switch body + Direct handle

External Operation



Switch body + Shaft + External handle

R5 Series



Ampere Rating	Three-Pole Toggle Switch Only ①	Three-Pole Rotary Switch Only	Direct Handle	Front and Right External Handle SH00 (Choose One)	Front and Right External Handle SH0 (Choose One)	Three-Position Front External Handle SH00 (Black) ②	Shaft for SH0 and SH00—5 x 5 mm—In (mm)
16	—	R5A3016U	DHR5	SH00 Black 3R, 12 SHB00N12	SH0 Black 3R, 12 SHB0N12	SH00 4, 4X I–0–II Open transition SHB00MTSOT	2.20 (55.5) SF55SH5X5
25	—	R5A3025U					
30	T5A3030U	R5A3030U					3.50 (90.0) SF90SH5X5
40	T5A3040U	R5A3040U					
60	T5B3060U	R5B3060U		SH00 Red 3R, 12 SHR00N12	SH0 Red 3R, 12 SHR0N12	SH00 4, 4X I–I–II–II Closed transition SHB00MTSCT	5.90 (150.0) SF150SH5X5
80	T5B3080U	R5B3080U		SH00 Black 4, 4X SHB00N4X	SH0 Black 4, 4X SHB0N4X		7.90 (200.0) SF200SH5X5
				SH00 Red 4, 4X SHR00N4X	SH0 Red 4, 4X SHR0N4X		12.60 (320.0) SF320SH5X5

Accessories



Ampere Rating	Switched Fourth-Pole Module	Unswitched Neutral Module	Auxiliary Contacts (Choose One)	Terminal Shrouds	Conversion Kit (Choose One) ②	Door Mounting Kit ③
16	S4PR516	UNMR5A	1NO + 1NC AC1NON	1P TS1R5A	6/8 pole CKR568	DMK
25	S4PR525					
30	S4PR530			3P TS3R5A	Changeover switch Open transition I–0–II MTSCKR50T	
40	S4PR540		2NO AC2N			
60	S4PR560 ②	UNMR5B		1P TS1R5B		
80	S4PR580 ②			3P TS3R5B	Changeover switch Closed transition I–I–II–II MTSCKR5CT	

Notes

- ① Toggle version includes direct handle.
- ② Available Q2 2011.
- ③ Includes shaft and accessory cap.

1

Non-Fusible 30–100A Compact**Features**

- Rating three-pole from 30A to 100A
- Direct or external operation handle (padlockable in ON position)
- Double breaking per phase
- Small footprint

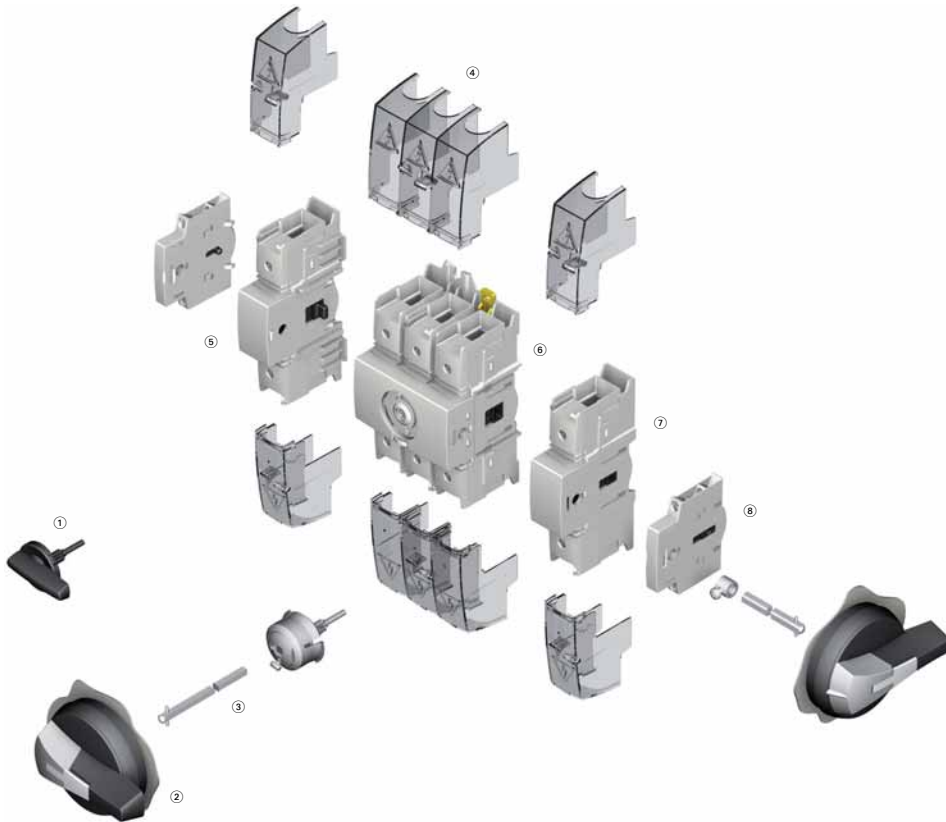
R9 Series Non-Fusible 30–100A Compact**Product Identification**

- ① Direct handle
- ② Door interlocked external handle
- ③ Shaft extension
- ④ Terminal shrouds
- ⑤ Unswitched neutral pole
- ⑥ Switch body
- ⑦ Switched fourth-pole module
- ⑧ Modular type auxiliary contacts

Note: For further details, please see the installation instructions supplied with each device.

Product Selection

Direct Operation



External Operation



R9 Series 30–100A

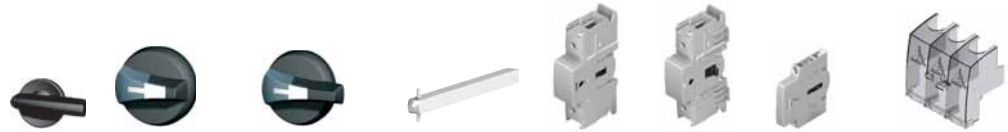

Ampere Rating (Frame)	Number of Poles	Switch Body Only	Direct Handle	Front and Right External Handle SH00 (Choose One)	Front and Right External Handle SH0 (Choose One)	Shaft for SH0 and SH00 Handles— In (mm) (Choose One)	Switched Fourth-Pole Module	Unswitched Neutral Module	Auxiliary Contacts (Choose One)	Terminal Shrouds (Choose One)
30 (C Frame)	3	R9C3030U	DHR9	SH00 Black 3R, 12 SHB00N12	SH0 Black 3R, 12 SHB0N12	2.20 (55.5) SF55SH5X5	S4PR930	Neutral UNMR9C	1NO + 1NC AC1N0NC	1P TS1R9
60 (C Frame)	3	R9C3060U		SH00 Red 3R, 12 SHR00N12	SH0 Red 3R, 12 SHR0N12	3.50 (90.0) SF90SH5X5	S4PR960		2NO AC2N	3P TS3R9CV
100 (C Frame)	3	R9C3100U		SH00 Black 4, 4X SHB00N4X	SH0 Black 4, 4X SHB0N4X	5.91 (150.0) SF150SH5X5	S4PR9100			
				SH00 Red 4 4X SHR00N4X	SH0 Red 4 4X SHR0N4X	7.87 (200.0) SF200SH5X5				
				SH00 Black 4, 4X SHB00N4X	SH0 Black 4, 4X SHB0N4X	12.60 (320.0) SF320SH5X5				
				SH00 Red 4 4X SHR00N4X	SH0 Red 4 4X SHR0N4X					

1

Non-Fusible 100–1200A**Features**

- High thermal and dynamic withstand ratings
- Arduous categories of applications
- High electrical and mechanical endurances

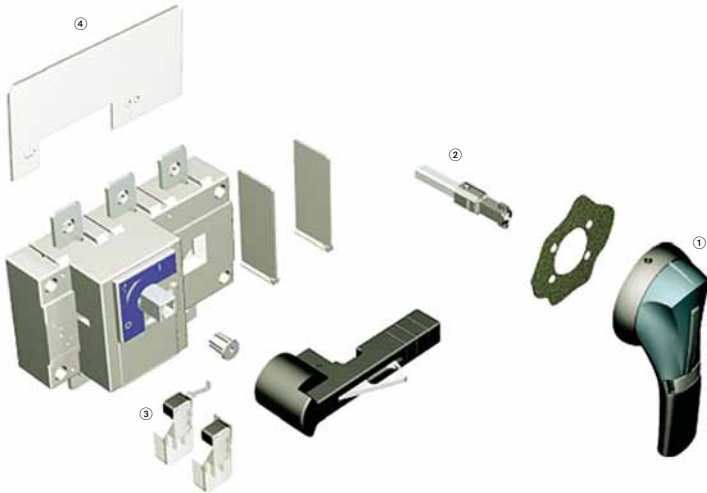
R9 Series Non-Fusible 100–1200A**Product Identification**

- ① External front handle
- ② Shaft extensions for external handle
- ③ Configurable U-type ACs, for pre-break and signalling or TEST
- ④ Terminal Screens

Note: For further details, please see the installation instructions supplied with each device.

Product Selection

Direct Operation

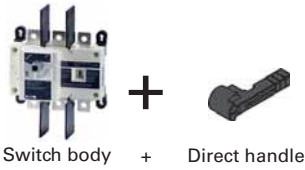

External Operation

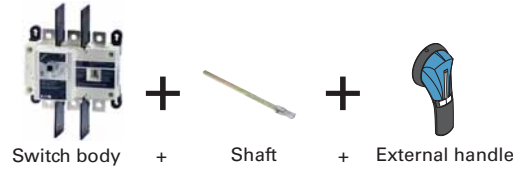

R9 Series Non-Fusible 100–1200A



Ampere Rating (Frame)	Number of Poles	Switch Body Only	Direct Handle	Door Interlocked External Pistol Handle (Choose One)	Shaft Extensions for External Handle—In (mm) (Choose One)	Auxiliary Contacts	Terminal Screens (Choose One)	Terminal Lugs ^③
100 (D Frame)	3	R9D3100U	DHR9DE	Size 2, Black 1, 3R, 12 Defeatable PHB2N12F	7.90 (200.0)	1NO + 1NC AC1N0NCDE AC1N0NCDELL	3-pole, Line side only TS3R9DT	LK3R9DL
	4	R9D4100U			SF200PH10X10		3-pole, Load side only TS3R9DB	LK4R9DL
200 (D Frame)	3	R9D3200U	DHR9DE	Size 2, Red 1, 3R, 12 Defeatable PHR2N12F	12.60 (320.0)	2NO + 2NC AC2N0NCDE AC2N0NCDELL	3-pole, Line or load side TS4R9DTB	LK3R9DL
	4	R9D4200U			SF320PH10X10		4-pole, Line or load side only TS4R9DTB	LK4R9DL
400 (E Frame)	3	R9E3400U	DHR9DE	Size 2, Black 4, 4X Defeatable PHB2N4XF	15.70 (400.0)	1NO AC U Type AC1N0R9 ^②	3-pole, Line side only TS3R9ET	LK3R9EM
	4	R9E4400U			SF400PH10X10		3-pole, Load side only TS3R9EB	LK4R9EM
600 (F Frame)	3	R9F3600U	DHR9FG	Size 2, Red 4, 4X Defeatable PHR2N4XF	19.70 (500.0)	1NC AC U Type AC1NCR9 ^②	4-pole, Line or load side TS4R9ETB	LK3R9FN
	4	R9F4600U			SF500PH10X10		3-pole, Line side only TS4R9F ^①	LK4R9FN
800 (G Frame)	3	R9G3800U	DHR9FG	Size 3, Black 4, 4X Defeatable PHB3N4XF	12.60 (320.0)	1NO AC U Type AC1N0R9 ^②	3-pole, Line side only TS3R9G ^①	LK6R9G
	4	R9G4800U			SF320PH15X12		3-pole, Load side only TS3R9G ^①	LK8R9G
1000 (G Frame)	3	R9G31000U	DHR9FG	Size 3, Red 4, 4X Defeatable PHR3N4XF	1.70 (400.0)	1NC AC U Type AC1NCR9 ^②	4-pole, Line or load side TS4R9G ^①	
	4	R9G41000U			SF400PH15X12			
1200 (G Frame)	3	R9G31200U	DHR9FG	Size 4, Black 4, 4X Defeatable PHB4N4XF	19.7 (500.0)	1NC AC U Type AC1NCR9 ^②		
	4	R9G41200U			SF500PH15X12			
				Size 4, Red 4, 4X Defeatable PHR4N4XF				

Notes

- ① Top (line side) supplied as standard.
- ② Auxiliary contact requires holder (catalog number ACHFG) when used on F and G Frame switches (non-fusible 600–1200A).
- ③ Each catalog number is for line or load side. For both line and load, please order two sets.

1

Fusible 30–800A



Features

- Load break functionality
- Double break contacts
- Up to 200 kA short-circuit rating with Class CC, J or L fuses
- Compact footprints
- Defeatable pistol handles automatically re-latch when the panel door is closed
- Front or right side operation
- NFPA 79 compliant kits
- Two-, three- and four-pole devices

R9 Series Fusible 30–800A

R9 Fusible 30A/CC and 30A/J (H Frame)— Direct and External Operation



Product Identification

- ① External front handles
- ② Direct handle
- ③ Shaft extensions for external handles
- ④ Configurable U Type ACs, for pre-break and signaling or TEST

R9 Fusible 30A/J–800A/L (I–N Frames)— Direct and External Operation

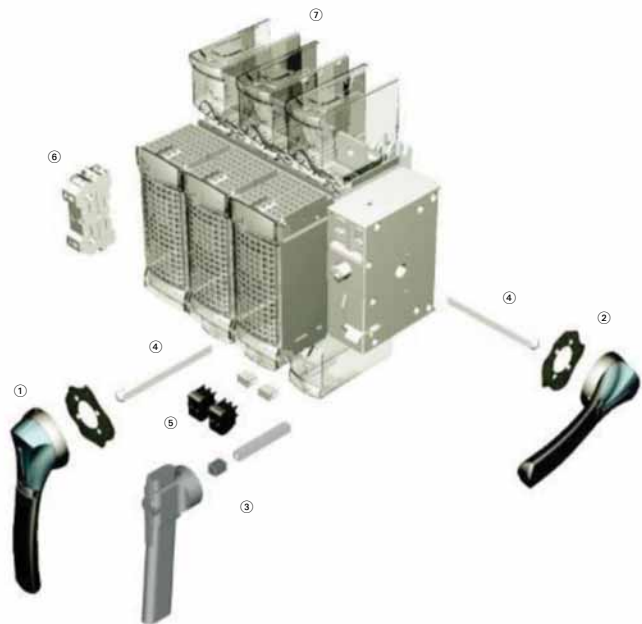

Product Identification

- ① External front handles
- ② External right side handle (not applicable for N Frame 600/800A)
- ③ Direct handle
- ④ Shaft extensions for external handles
- ⑤ Configurable U Type ACs, for pre-break and signaling or TEST
- ⑥ Side auxiliary contacts
- ⑦ Terminal shrouds

Product Selection

Direct Operation



Switch body + Direct handle

External Operation



Switch body + Shaft + External handle

Front and Right Side Operation

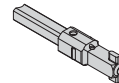

Ampere Rating (Frame) (Fuse Class)	Number of Poles	Switch Body Only	Direct Handle	External Selector Handle (Choose One)	Shaft Extension for Selector Handle Only (Choose One)	External Front Pistol Handle	External Right Side Pistol Handle
30 Compact (H Frame) (CC)	3	R4H3030FCC	DHR9HC	Black 1,3R,12 SHB0N12HV	7.90 (200.0) SF200SH5X5H	Black 1,3R,12 PHB1N12F	—
30 (H Frame) (CC)	3 + switched neutral	R4H3030FCCSN		Red 1,3R,12 SHR0N12HV	12.60 (320.0) SF320SH5X5H	Red 1,3R,12 PHR1N12F	
30 Compact (H Frame) (J)	3	R4H3030FJ	DHR9HJ	Black 4,4X SHB0N4XHV	15.70 (400.0) SF400SH5X5H	Black 4,4X PHB1N4XF	
30 (H Frame) (J)	3 + switched neutral	R4H3030FJSN		Red 4,4X SHR0N4XHV		Red 4,4X PHR1N4XF	
30 (I Frame) (CC)	3	R9I3030FCC	DHR9J2M	—	—		
	4	R9I4030FCC					
30 (J Frame) (J)	2	R9J2030FJ				Black 4,4X (w/ TEST Position) PHB1N4XFT	Black 4, 4X PHB1N4XS
	3	R9J3030FJ					
	4	R9J4030FJ					
60 ① (J Frame) (J)	2	R9J2060FJ				Red 4,4X (w/ TEST Position) PHR1N4XFT	Red 4, 4X PHR1N4XS
	3	R9J3060FJ					
	4	R9J4060FJ					

Note

① 100 kA short-circuit rating.

1.3

Circuit Protection

Rotary Disconnect Switches

1

Front and Right Side Operation, continued



Ampere Rating (Frame) (Fuse Class)	Number of Poles	Switch Body Only	Shaft Extensions for Pistol Handle Only In (mm) (Choose One)	NFPA 79 Kit	Auxiliary Contacts (Choose One)	S Type Auxiliary Contacts (Choose One)	Terminal Shrouds
30 Compact (H Frame) (CC)	3	R4H3030FCC	7.90 (200.0) SF200PH5X5	NFPA79H	1 AC NO AC1NOR9	—	Integral to switch
30 (H Frame) (CC)	3 + switched neutral	R4H3030FCCSN	12.60 (320.0) SF320PH5X5		1 AC NC AC1NCR		
30 Compact (H Frame) (J)	3	R4H3030FJ	15.70 (400.0) SF400PH5X5				
30 (H Frame) (J)	3 + switched neutral	R4H3030FJSN					
30 (I Frame) (CC)	3	R9I3030FCC	7.90 (200.0) SF200PH10X10	NFPA79JKL		1 AC NO + NC AC1N01NCJ2N	
	4	R9I4030FCC					
30 (J Frame) (J)	2	R9J2030FJ	12.60 (320.0) SF320PH10X10			2 AC NO + NC AC2N02NCJ2N	
	3	R9J3030FJ					
	4	R9J4030FJ	15.70 (400.0) SF400PH10X10				
60 [Ⓢ] (J Frame) (J)	2	R9J2060FJ				1 AC NO + NC w/ TEST AC1N01NCJ2NT	
	3	R9J3060FJ	19.70 (500.0) SF500PH10X10				
	4	R9J4060FJ				2 AC NO + NC w/ TEST AC2N02NCJ2NT	

Note

Ⓢ 100 kA short-circuit rating.

Front and Right Side Operation, continued



Ampere Rating (Frame) (Fuse Class)	Number of Poles	Switch Body Only	Direct Handle (Black)	External Front Pistol Handle (Choose One)	External Right Side Pistol Handle (Choose One)
60 ① (K Frame) (J)	2	R9K2060FJ	DHR9J2M	Black	Black
	3	R9K3060FJ		1,3R,12	4, 4X
	4	R9K4060FJ		PHB2N12F	PHB2N4XS
100 (K Frame) (J)	2	R9K2100FJ		Red	Red
	3	R9K3100FJ		1,3R,12	4, 4X
	4	R9K4100FJ		PHR2N12F	PHR2N4XS
200 (L Frame) (J)	2	R9L2200FJ		Black	
	3	R9L3200FJ		4,4X	
	4	R9L4200FJ		PHB2N4XF	
400 (M Frame) (J)	3	R9M3400FJ		Red	
	4	R9M4400FJ		4,4X	
				PHR2N4XF	
600 (N Frame) (J)	2	R9N2600FJ	DHR9N	Black	
	3	R9N3600FJ		4,4X	
	4	R9N4600FJ		PHB2N4XF	
800 (N Frame) (L)	2	R9N2800FL		Red	
	3	R9N3800FL		4,4X	
	4	R9N4800FL		PHR2N4XF	
				Black	
				4,4X	
				(w/ TEST Position)	
				PHB2N4XF	
				Red	
				4,4X	
				(w/ TEST Position)	
				PHR2N4XF	

Note

① 200 kA short-circuit rating.

1.3

Circuit Protection

Rotary Disconnect Switches

1

Front and Right Side Operation, continued

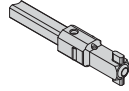

Ampere Rating (Frame) (Fuse Class)	Number of Poles	Switch Body Only	Shaft Extensions for External Handle In (mm) (Choose One)	NFPA 79 Kit	Auxiliary Contacts (Choose One)	Auxiliary Contacts (Choose One)	Terminal Shrouds
60 [Ⓞ] (K Frame) (J)	2	R9K2060FJ	7.90 (200.0)	NFPA79JKL	1 AC NO AC1NOR9	1 AC NO + NC AC1N01NCJ2N	Integral to switch
	3	R9K3060FJ	Pistol SF200PH10X10				
	4	R9K4060FJ					
100 (K Frame) (J)	2	R9K2100FJ	12.60 (320.0)	AC1NCR9	1 AC NC AC1NCR9	2 AC NO + NC AC2NO2NCJ2N	
	3	R9K3100FJ	Pistol SF320PH10X10				
	4	R9K4100FJ					
200 (L Frame) (J)	2	R9L2200FJ	15.70 (400.0)			1 AC NO + NC w/ TEST AC1N01NCJ2NT	TSR9L2
	3	R9L3200FJ	Pistol SF400PH10X10				TSR9L3
	4	R9L4200FJ	19.70 (500.0) Pistol SF500PH10X10				TSR9L4
400 (M Frame) (J)	3	R9M3400FJ				2 AC NO + NC w/ TEST AC2NO2NCJ2NT	TSR9M3
	4	R9M4400FJ					TSR9M4
600 (N Frame) (J)	2	R9N2600FJ	7.90 (200.0)	NFPA79N		1 AC NO + NC AC1N01NCJ2N	TSR9N2
	3	R9N3600FJ	Pistol SF200PH12X12				TSR9N3
	4	R9N4600FJ					TSR9N4
800 (N Frame) (L)	2	R9N2800FL	12.60 (320.0)			2 AC NO + NC AC2NO2NCJ2N	TSR9N2
	3	R9N3800FL	Pistol SF320PH12X12				TSR9N3
	4	R9N4800FL	15.70 (400.0) Pistol SF400PH12X12				TSR9N4
			19.70 (500.0) Pistol SF500PH12X12				

Note

[Ⓞ] 200 kA short-circuit rating.

DC Rated Disconnects



Features

- Switching technology
- Up to 600 Vdc according to UL 98/CSA
- Up to 1000 Vdc according to IEC 947-3

R9 Series DC Rated Disconnects

Product Selection

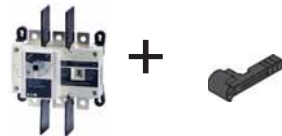

Switch body + Direct handle

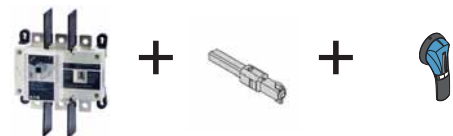

Switch body + Shaft + External handle

Front Operation—Three- and Four-Pole

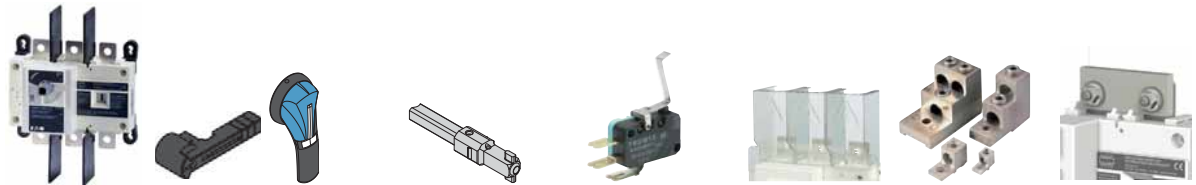

Ampere Rating	Number of Poles	Switch Body	Direct Handle	External Handle (Choose One)	Shaft for External Handle In (mm) (Choose One)	Auxiliary Contacts (Choose One)	Terminals Shroud	Terminal Lugs	Jumpers for Connecting Poles in Series
100	3	R9D3100UDC	DHR9DE	S2 Type	7.90 (200.0)	C Type	3P ②	3P ④	2 pieces
	4	R9D4100UDC		Black 1, 3R, 12 ①	SF200PH10X10	1st Contact NO+NC	TS3R9DT	LK3R9DL	DCJUMP2
200	3	R9D3200UDC		PHB2N12F	12.60 (320.0)	AC1NONCDE	3P ③	4P ④	3 pieces
	4	R9D4200UDC		Red/Yellow 1, 3R, 12 ①	SF320PH10X10	2nd Contact NO+NC	TS3R9DB	LK4R9DL	DCJUMP3
400	3	R9E3400UDC		Black 4, 4X ①	15.7 0 (400.0)	AC2NONCDE	4P ④		
	4	R9E4400UDC		PHB2N4XF	SF400PH10X10		TS4R9DTB		
							3P ②	3P ④	2 pieces
							TS3R9ET	LK3R9EM	DCJUMPE2
							3P ③	4P ④	3 pieces
							TS3R9EB	LK4R9EM	DCJUMPE3
							4P ④		
							TS4R9ETB		

Notes

- ① Defeatable handle.
- ② Top (line side).
- ③ Bottom (load side).
- ④ Top or bottom (line or load side).

1

Manual Transfer Switches**Features**

- Three load break positions (I, 0, II)
- On load switching
- Direct or external handle
- 480 Vac total system
- 600 Vac resistive load

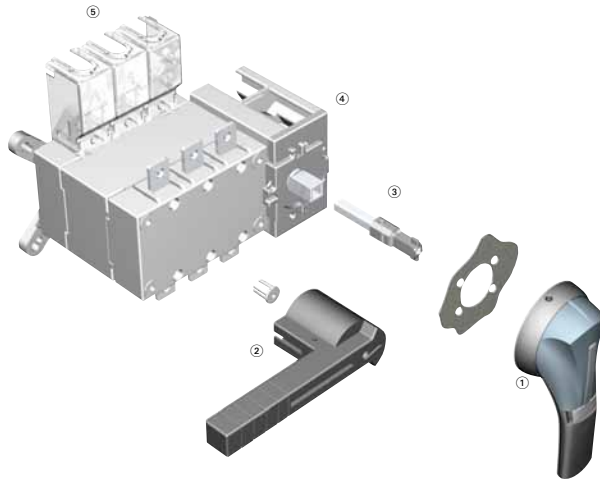
Manual Transfer Switches**Product Identification**

- ① External front handle
- ② Direct handle
- ③ Shaft extension for external handle
- ④ Pre-break ACs (standard on 600–1200A)
- ⑤ Terminal Screen

Product Selection

Direct Operation

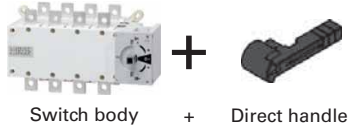

External Operation

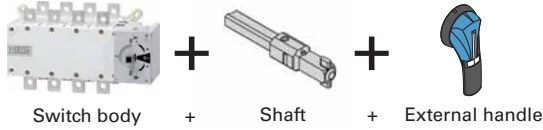

Manual Transfer Switches—UL 98 Standard ①

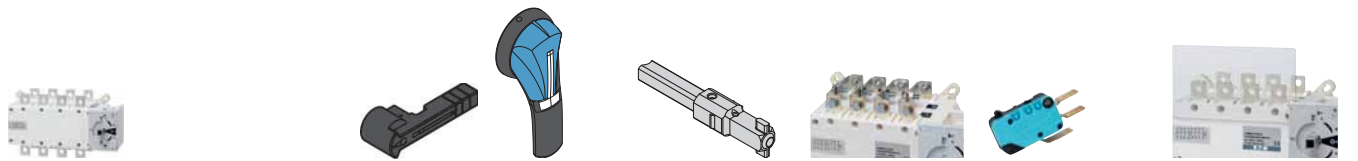

Ampere Rating	Number of Poles	Switch Body Only ①	Direct Handle (Black)	External Three-Position Handle (Choose One)	Shaft Extensions for External Handle In (mm) (Choose One)	Bridging Bars	Auxiliary Contacts	Terminal Screens ②	
100	3	RMTS3100U	DHMTSSL	Size 2, Black I–0–II Type 4/4X PHB2N4X3P	7.90 (200.6) SF200PH10X10	3P BB3P200	NO/NC AC1NONCMTS400	3P TS3MTS200TB	
	4	RMTS4100U			12.60 (320.0) SF320PH10X10			4P BB4P200	4P TS4MTS200TB
200	3	RMTS3200U		Size 2, Red I–0–II Type 4/4X PHR2N4X3P	15.70 (398.8) SF400PH10X10		Low level AC1NONCMTS400LL ③		
	4	RMTS4200U							
400	3	RMTS3400U		Size 3, Black I–0–II Type 4/4X PHB3N4X3P	7.90 (200.6) SF200PH15X12	3P BB3P400		3P TS3MTS400TB	
	4	RMTS4400U			12.60 (320.0) SF320PH15X12			4P BB4P400	4P TS4MTS400TB
					15.70 (398.8) SF400PH15X12				
600	3	RMTS3600U	DHMTSDL	Size 4, Black I–0–II Type 4/4X PHB4N4X3P		3P BB3P600	NO/NC contact standard	3P TS3MTS600	
	4	RMTS4600U						4P BB4P600	4P TS4MTS600
800	3	RMTS3800U	DHMTSDLM	Size 4, Red I–0–II Type 4/4X PHR4N4X3P		3P BB3P1200		3P TS3MTS1200	
	4	RMTS4800U				4P BB4P1200		4P TS4MTS1200	
1200	3	RMTS31200U						3P TS3MTS1200	
	4	RMTS41200U						4P TS4MTS1200	

Notes

- ① All ratings, 100–1200A, are UL 98 listed. Switches are to be UL 1008 listed in 2011.
- ② Line or load (top or bottom); for both line and load, order two kits.
- ③ Low level auxiliary contact—gold plated for minimal resistance—for PLC applications.

Enclosed Rotary Disconnects**Features**

- Padlockable in the OFF position (up to three padlocks) to meet OSHA lockout requirements
- Available in 16–80A ratings
- 600 Vac, three- and four-pole non-fusible device
- Rated for making and breaking loads
- Accepts auxiliary contacts; capability to signal PLC controllers
- Ground lug connection provided
- Possibility of adding one power pole and one auxiliary contact
- NEMA Type 1, 3R, 12, 4, 4X
- 65kAIC rating when applied downstream from appropriate fusing

Enclosed Rotary Disconnects

Provide users with the ability to lock directly wired motor loads in the OFF position to comply with OSHA lockout/tagout regulations. Also for machine applications that require compact, economical disconnect switches.

Enclosed rotary disconnect switches allow safe control and safe disconnect of any motor application.

Open rotary disconnects can be found on **Pages V9-T1-46 to V9-T1-61** and full information in Volume 5, Motor Control and Protection, CA08100006E, Tab 8.

Product Selection

Enclosed Rotary Non-Fusible

Ampere Rating	Maximum Horsepower Ratings				NEMA 1 ^① Enclosure Indoor Catalog Number	NEMA 12 ^{①②} Enclosure Dust-Tight/ Rainproof Catalog Number	NEMA 4X ^① Enclosure Corrosion-Resistant, Stainless Steel Catalog Number	NEMA 4X ^① Enclosure Corrosion-Resistant, Non-Metallic Catalog Number	NEMA 4X Enclosure Polycarbonate- Non-Metallic Catalog Number
	Three-Phase AC								
	208V	240V	480V	600V					
Three-Pole, 600 Vac									
16	3	5	10	10	ER53016UG	ER53016UD	ER53016UW	ER53016UX	—
25	7-1/2	7-1/2	15	20	ER53025UG	ER53025UD	ER53025UW	ER53025UX	—
30	7-1/2	7-1/2	15	20	ER53030UG	ER53030UD	ER53030UW	ER53030UX	ER53030UPYR ^{③④}
40	7-1/2	7-1/2	20	25	ER53040UG	ER53040UD	ER53040UW	ER53040UX	—
60	15	15	30	30	ER53060UG	ER53060UD	ER53060UW	ER53060UX	ER53060UPYR ^{③④}
80	15	20	40	40	ER53080UG	ER53080UD	ER53080UW	ER53080UX	—
Four-Pole, 600 Vac									
16	3	5	10	10	ER54016UG	ER54016UD	ER54016UW	ER54016UX	—
25	7-1/2	7-1/2	15	20	ER54025UG	ER54025UD	ER54025UW	ER54025UX	—
30	7-1/2	7-1/2	20	25	ER54030UG	ER54030UD	ER54030UW	ER54030UX	—
40	7-1/2	7-1/2	20	25	ER54040UG	ER54040UD	ER54040UW	ER54040UX	—

Accessories for Enclosed Rotary Disconnects^{⑤⑥}

Disconnect Ampere Rating	Switched Fourth Pole	Unswitched Neutral Pole	Auxiliary Contacts (Choose One)	Terminal Shrouds
16	S4PR516	UNMR5A	1NO + 1NC AC1NONC	Single-pole TS1R5A
25	S4PR525			
30	S4PR530		2NC AC2NC	Three-pole TS3R5A
40	S4PR540			
60	S4PR560 ^⑦	UNMR5B ^⑦		Single-pole TS1R5B
80	S4PR580 ^⑦			Three-pole TS3R5B

Notes

- ① For CSA listed switches, add prefix letter "C" to the front of the catalog number.
- ② NEMA Type 12 enclosures (16–80A) can be field modified to meet NEMA Type 3R rainproof requirements when a factory-provided drain hole is opened.
- ③ YR suffix indicates **Y**ellow cover with **R**ed handle. For **G**ray cover with **B**lack handle, replace "YR" with "GB." For **G**ray cover with **R**ed handle, replace "YR" with "GR."
- ④ cULus only.
- ⑤ Ordered and shipped as separate components—not integral to enclosed device.
- ⑥ Enclosed disconnects can accept one power pole, neutral or up to two auxiliary contacts (one mounted on either side of switch).
- ⑦ Available 2011.

Contact the Safety Switch Flex Center (1-888-329-9272) for factory-installed accessories or other special modifications.

Contactors



Motor Protection and Monitoring Relays



Manual Motor Protectors and Controllers



Soft Starters



Drives



2.1 Contactors

Product Overview	V9-T2-2
Compact Definite Purpose Contactors	V9-T2-3
50 mm C25 Definite Purpose Contactors	V9-T2-5
XT IEC Miniature Contactors	V9-T2-7
XT IEC Contactors	V9-T2-9

2.2 Motor Protection and Monitoring Relays

Product Overview	V9-T2-15
D65 Series Monitoring Relays	V9-T2-17
D65C Series Monitoring Relays	V9-T2-19
XT IEC Miniature Overload Relays	V9-T2-22
XTOB, XTOT Thermal Overload Relays	V9-T2-23
XT Electronic Overload Relays	V9-T2-26
Motor Insight Overload and Monitoring Relays	V9-T2-32

2.3 Manual Motor Protectors and Controllers

Product Overview	V9-T2-36
XT IEC Manual Motor Protectors	V9-T2-37
XT IEC Manual and Combination Motor Controllers	V9-T2-41

2.4 Soft Starters

Product Overview	V9-T2-47
DS7 Soft Start Controller	V9-T2-48
DS6 Soft Start Controller	V9-T2-50
S611 Soft Starter	V9-T2-51
S801+ Soft Starter	V9-T2-55
S811+ Soft Starter	V9-T2-58

2.5 Drives

Product Overview	V9-T2-65
M-Max Machinery Drive	V9-T2-66
SVX9000 Drives	V9-T2-68

For our complete product offering, see Volume 5—Motor Control and Protection, CA08100006E and Volume 6—Solid-State Motor Control, CA08100007E.

2.1

Motor Control and Protection

Contactors

Product Overview

Contactors Selection Guide

2



Description	Definite Purpose Contactors	X7IEC Miniature Contactors	X7IEC Contactors
	Page V9-T2-3	Page V9-T2-7	Page V9-T2-9
Type	Definite purpose	IEC	IEC
Approvals	UL [®] Recognized, CSA [®] , CE, ARI, RoHS	UL, IEC EN 60947, CE, CSA, RoHS	UL, IEC EN 60947, CE, CSA, RoHS
Technical Data			
Pole configurations	1P, 2P, 3P, 4P	3P, 4P	3P, 4P
Inductive Amp ratings	To 360A	To 8.8A (AC-3)	To 1600A (AC-3)
Resistive Amp ratings	To 360A	To 20A (AC-1)	To 3185A (AC-1)
Typical electrical operations	To 300,000	To 750,000	To 1,400,000

For our complete product offering, see Volume 5—Motor Control and Protection, CA08100006E.

Compact Definite Purpose Contactors



Features

- Insulation voltage: 690V
- Current rated and hp/kW rated
- Magnet coil: Class F, 155°C
- Contact arc covers are standard on all contactors

Product Selection

Compact Definite Purpose Contactors—Open Type

Ampere Ratings ①

Inductive Full Load	Resistive	Locked Rotor 240–277V	Catalog Number ②
Single-Pole			
30	40	150	C25ANB130_
40	50	240	C25ANB140_
Single-Pole with Shunt			
30	40	150	C25CNB130_
40	50	240	C25CNB140_
Two-Pole			
25	35	150	C25BNB225_
30	40	150	C25BNB230_
40	50	240	C25BNB240_

Magnet Coil Selection

AC Coil Voltage 50/60 Hz	Coil Suffix
24	T
110–120	A
208–240	B

Notes

- ① Rating per pole.
- ② Replace underscore (_) in catalog number with coil suffix letter from table at left.

2.1

Motor Control and Protection

Contactors

Catalog Number Selection

Definite Purpose Contactors

2

Definite Purpose Contactors

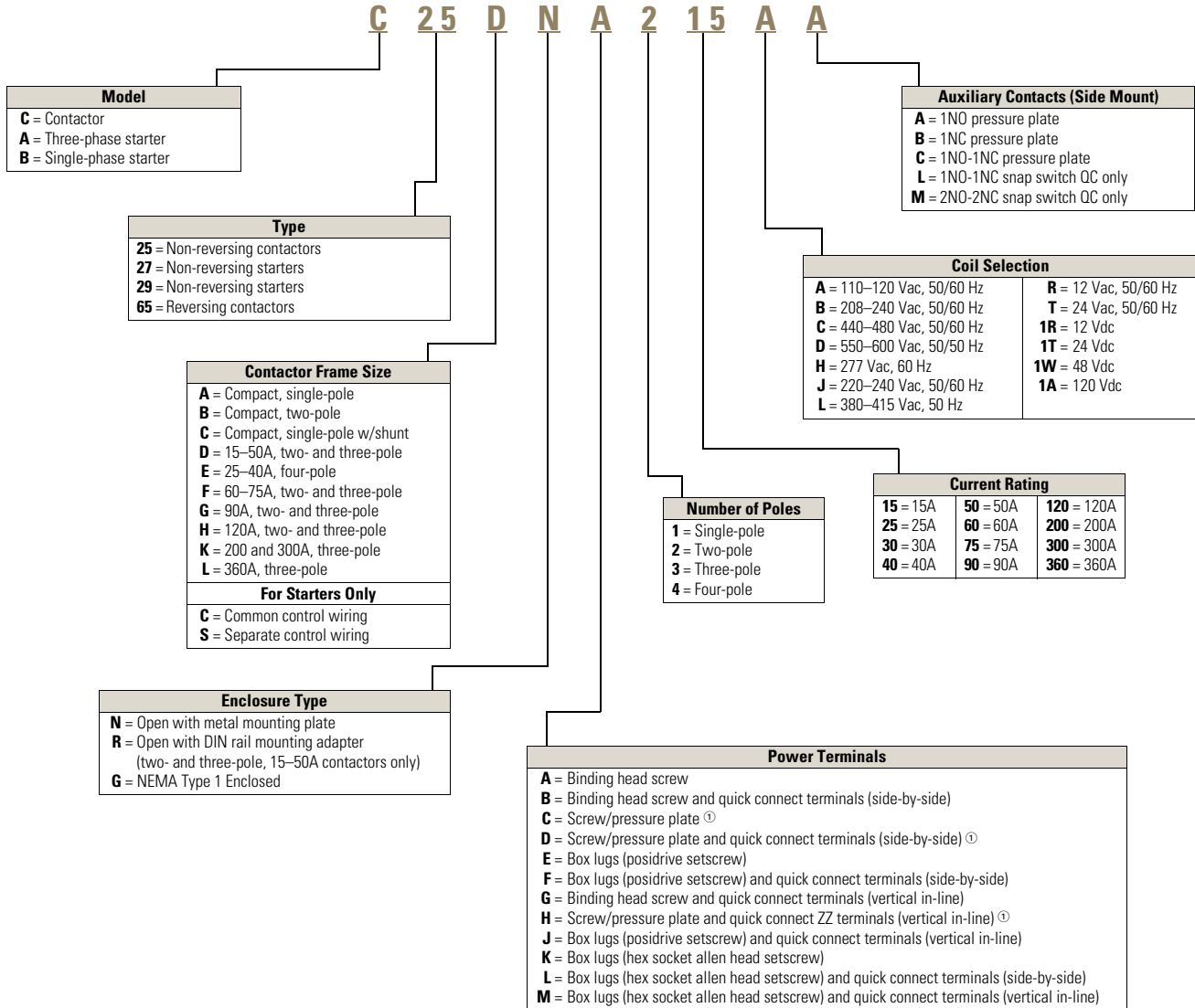

Note

① Not available on 50A devices.

50 mm C25 Definite Purpose Contactors



Features

- Contactors are dual-rated with inductive and resistive ratings, as well as horsepower and kilowatt ratings
- Contactors rated 15–50A are available with DIN rail mount as a factory installed option
- Magnet coil: Class B (C25E, F, G, H and K), 130°C
- Ambient temperature: 150°F (65°C) maximum

Product Selection

50 mm C25 Definite Purpose Contactors

C25 Contactors—Open Type

Rating, Amperes Inductive Full Load	Resistive per Pole	Line Voltage	Locked Rotor	Maximum Motor Horsepower		Open Type with Metal Mounting Plate Catalog Number ^{①②}	Open Type with DIN Rail Adapter Catalog Number ^{①②}
				Single-Phase	Three-Phase		
15	20	230	90	2	3	C25DND315_	C25DRD315_
		460	75	—	5		
		575	60	—	5		
25	35	230	150	3	7-1/2	C25DND325_	C25DRD325_
		460	125	—	10	C25END425_	
		575	100	—	10		
30	40	230	180	5	10	C25DND330_	C25DRD330_
		460	150	—	15	C25END430_	
		575	120	—	15		
40	50	230	240	7-1/2	10	C25DNF340_	C25DRF340_
		460	200	—	20	C25ENF440_	
		575	160	—	20		
50	65	230	300	10	15	C25DNJ350_	C25DRJ350_
		460	250	—	30		
		575	200	—	30		
60	75	230	360	10	20	C25FNF360_	—
		460	300	—	40		
		575	240	—	40		
75	90	230	450	15	20	C25FNF375_	—
		460	375	—	50		
		575	300	—	50		

Magnet Coil Selection

Voltage 60 Hz	50 Hz	Coil Suffix
AC ^③		
24 ^④	24	T
110–120 ^⑤	110–120 ^⑤	A
208–240 ^⑤	208–240	B
DC ^⑥		
24		1T

Notes

- ① Replace underscore (_) in catalog number with magnet coil suffix from table at left.
- ② Carton quantities including 20 individually packaged units are available for two- and three-pole units through 60A inductive.
- ③ Class H AC coils available as option for 15–50A contactor. Add 2 before AC coil suffix letter.
- ④ Available through 120A.
- ⑤ 104–120V 50/60 Hz for 60A, 75A and all four-pole contactors (25–40A).
- ⑥ Contactors with DC coils (only available up to 75A) include an early break NC auxiliary contact, C320KGD1.

2.1

Motor Control and Protection

Contactors

Reversing and Two-Speed Contactors—Open Type—Unwired, Mechanically Interlocked Only

2

Rating, Amperes Inductive Full Load	Resistive per Pole	Line Voltage	Locked Rotor	Maximum Motor Horsepower		Open Type with Metal Mounting Plate Catalog Number ^①
				Single-Phase	Three-Phase	
15	20	230	90	2	3	C65DND315_
		460	75	—	5	
		575	60	—	5	
25	35	230	150	3	7-1/2	C65DND325_
		460	125	—	10	
		575	100	—	10	
30	40	230	180	5	10	C65DND330_
		460	150	—	15	
		575	120	—	15	
40	50	230	240	7-1/2	10	C65DNF340_
		460	200	—	20	
		575	160	—	20	
50	65	230	300	10	15	C65DNJ350_
		460	250	—	30	
		575	200	—	30	

Magnet Coil Selection

Voltage 60 Hz	50 Hz	Coil Suffix ^②
24	24	T
110–120 ^③	110–120 ^③	A
208–240 ^④	208–240	B

Notes

- ① Replace underscore (_) with magnet coil suffix from table at left.
- ② Class H AC coils available as option for 15–50A contactor. Add Z before AC coil suffix letter.
- ③ 104–120V 50/60 Hz for 60A, 75A.
- ④ Available through 50A.

XTIEC Miniature Contactors



Features

- Reversing or non-reversing
- Three- and four-pole configurations
 - Three-pole XTMC
 - Four-pole XTMF
- Panel or DIN rail mounting
- IP20 finger and back-of-hand proof
- Direct mount with XTOM miniature overload relays

Catalog Number Selection

XTIEC Miniature Contactors

Miniature Contactors

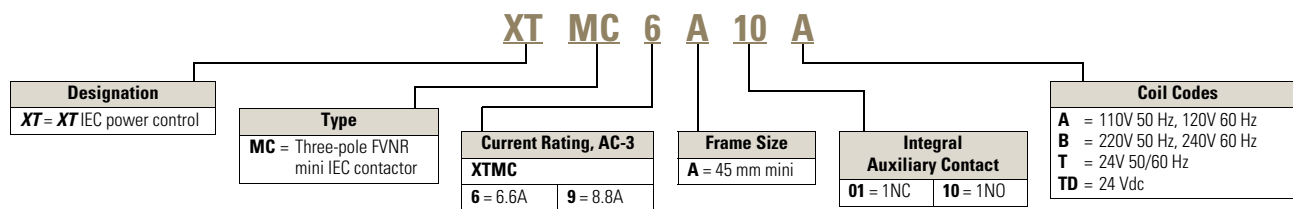

Product Selection

Full Voltage Non-Reversing Miniature Contactors

Operational Current AC-3 Amp Rating 380/400V	Conventional Free Air Thermal Current AC-1 at 50°C	Maximum kW Ratings AC-3 Three-Phase Motors, 50–60 Hz				Maximum Three-Phase Motor Ratings Single-Phase hp Ratings				Maximum Three-Phase Motor Ratings Three-Phase hp Ratings				Number of Power Poles	Auxiliary Contacts	Catalog Number—Screw Terminals ①
		220–240V	380–400V	550V	660/690V	115V	200V	230V	200V	230V	460V	575V				
6.6	20	1.5	3	3	3	1/4	3/4	1	1-1/2	2	3	3	3	1NO	XTMC6A10_	
6.6	20	1.5	3	3	3	1/4	3/4	1	1-1/2	2	3	3	3	1NC	XTMC6A01_	
8.8	20	2.2	4	4	4	1/2	1	1-1/2	2	3	5	5	3	1NO	XTMC9A10_	
8.8	20	2.2	4	4	4	1/2	1	1-1/2	2	3	5	5	3	1NC	XTMC9A01_	
8.8	20	2.2	4	4	4	1/2	1	1-1/2	2	3	5	5	4	—	XTMF9A00_	

Magnet Coil Suffix

Coil Voltage	Suffix Code
110V 50 Hz, 120V 60 Hz	A
220V 50 Hz, 240V 60 Hz	B
24V 50/60 Hz	T
24 Vdc	TD ②
415V 50 Hz, 480V 60 Hz	C
550V 50 Hz, 600V 60 Hz	D
208V 60 Hz	E

IEC Utilization Categories

AC-1: Non-inductive or slightly inductive loads.

AC-3: Squirrel cage motors—starting, switching of motors during running.

AC-4: Squirrel cage motors—starting, plugging, inching.

Notes

- ① Underscore (_) indicates magnet coil suffix required. See table at left.
- ② With DC operation: Integrated diode resistor combination, coil rating 2.6W.

Accessories

2

Front Mount Auxiliary Contacts ^①

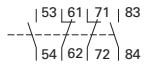
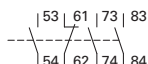
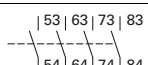
Conventional Free Air Thermal Current, $I_{th} = I_{\theta}$, AC-1 in Amps	Contact Configuration	Contact Sequence	Package Qty.	Catalog Number—Screw Terminals
10	1NO-1NC		5	XTMCXFA11
10	2NO-2NC		5	XTMCXFA22
10	3NO-1NC		5	XTMCXFA31
10	4NO		5	XTMCXFA40

XT IEC Miniature Contactors

Description	Package Qty.	Catalog Number
Mechanical interlock	5	XTMCXML
Reversing link kit—main current wiring for reversing contactors and starters	1	XTMCXRL ^②
Connector—for mechanically arranging contactors and timing relays in combinations	50	XTMCXCN ^③

Notes

- ^① For two contactors with AC or DC operated magnet system that are horizontally or vertically mounted, the distance between contactors is 0 mm, and the mechanical lifespan is 2.5×10^6 operations. The following control cables are integrated as part of the electrical interlock:
K1M: A1—K2M: 21; K1M: 21—K2M: A1.
- ^② Reversing link kit does not include mechanical interlock.
- ^③ 0 mm distance between contactors.

XT IEC Contactors



Features

- Reversing or non-reversing contactors
- AC-3 contactor ratings to 1600A and AC-1 contactor ratings to 2000A
- Panel or DIN rail mounting to 65A
- IP20 finger and back-of-hand proof
- Built-in NO or NC auxiliary contacts to 32A
- Built-in surge suppression on DC coils XTCE Frame B-G and AC or DC coils on XTCE Frame L-R
- Can be used with **XT** or C396 overload relays
- Can be used with XTPR MMPs for manual motor controllers or UL508 Type F combination motor controllers

Catalog Number Selection

XT IEC Contactors

Contactors

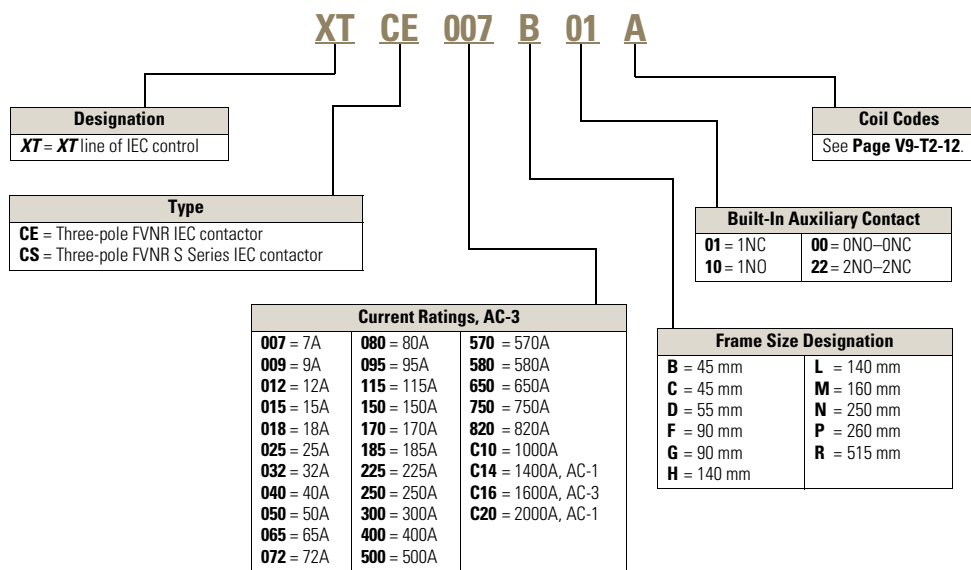

2.1

Motor Control and Protection

Contactors

Product Selection

2

Full Voltage Non-Reversing Three-Pole Contactors, Frames B–G

UL/CSA Ratings UL General Purpose Amp Rating	Single-Phase hp Ratings							Three-Phase hp Ratings			IEC Ratings				Auxiliary Contacts	Catalog Number—Screw Terminals ^{①②}
	115V	200V	230V	200V	230V	460V	575V	AC-3 I _e (A)	AC-1 (40°C) I _e = I _{th} (A)	Maximum kW Ratings AC-3 Three-Phase Motors 50–60 Hz						
										220/230V	380/400V	415V	660/690V			
Frame B																
20	1/4	3/4	1	1-1/2	2	3	5	7	22	2.2	3	4	3.5	1NO	XTCE007B10_	
20	1/4	3/4	1	1-1/2	2	3	5	7	22	2.2	3	4	3.5	1NC	XTCE007B01_	
20	1/2	1	1-1/2	3	3	5	7-1/2	9	22	2.5	4	5.5	4.5	1NO	XTCE009B10_	
20	1/2	1	1-1/2	3	3	5	7-1/2	9	22	2.5	4	5.5	4.5	1NC	XTCE009B01_	
20	1	2	2	3	3	10 ^③	10	12	22	3.5	5.5	7	6.5	1NO	XTCE012B10_	
20	1	2	2	3	3	10 ^③	10	12	22	3.5	5.5	7	6.5	1NC	XTCE012B01_	
20	1	2	3	5	5	10 ^③	10	15.5	22	4	7.5	8	7	1NO	XTCE015B10_	
20	1	2	3	5	5	10 ^③	10	15.5	22	4	7.5	8	7	1NC	XTCE015B01_	
Frame C																
40	2	2	3	5	5	10 ^③	15	18	40	5	7.5	10	11	1NO	XTCE018C10_	
40	2	2	3	5	5	10 ^③	15	18	40	5	7.5	10	11	1NC	XTCE018C01_	
40	2	3	5	7-1/2	10	15	20	25	45	7.5	11	14.5	14	1NO	XTCE025C10_	
40	2	3	5	7-1/2	10	15	20	25	45	7.5	11	14.5	14	1NC	XTCE025C01_	
40	3	5	5	10	10	20	25	32	45	10	15	18	17	1NO	XTCE032C10_	
40	3	5	5	10	10	20	25	32	45	10	15	18	17	1NC	XTCE032C01_	
Frame D																
63	3	5	7-1/2	10	15	30	40	40	60	12.5	18.5	24	23	—	XTCE040D00_	
80	3	7-1/2	10	15	20	40	50	50	80	15.5	22	30	30	—	XTCE050D00_	
88	5	10	15	20	25	50	60	65	98	20	30	39	35	—	XTCE065D00_	
88	5	10	15	20	25	50	60	72	98	22	37	41	35	—	XTCE072D00_	
Frame F																
125	7-1/2	15	15	25	30	60	75	80	110	25	37	48	63	—	XTCE080F00_	
125	7-1/2	15	15	25	40	75	75	95	130	30	45	57	75	—	XTCE095F00_	
Frame G																
160	10	25	25	40	50	100	100	115	160	37	55	70	90	—	XTCE115G00_	
180	10	25	30	40	60	125	125	150	190	48	75	91	96	—	XTCE150G00_	
225 ^④	10	25	30	40	60	125	125	170	225	52	90	100	96	—	XTCE170G00_	

Notes

The 7–32A XTCE contactors have positively driven contacts between the integrated auxiliary contact and the auxiliary contact module as well as within the auxiliary contact modules.

The 40–65A XTCE contactors have positively driven contacts within the auxiliary contact module. Six auxiliary contacts are possible with a combination of side mounted and front mount auxiliary contacts.

DC operated contactors (Frames B–G, 7–150A) have a built-in suppressor circuit.

Frames B–C contactors with 1NC built-in auxiliary are mirror contacts (XTCE...B01_–XTCE...C01_).

① Underscore (_) indicates magnet coil suffix required. See **Page V9-T2-12**.

② For spring cage terminals, insert C after the fourth digit of the catalog number. Example: XTCE C 007B10A.

For 7–12A XTCEC contactors, the power, auxiliary and coil terminals are spring cage.

For 18–32A XTCEC contactors, the auxiliary and coil terminals are spring cage.

For 40–150A XTCEC contactors, the coil terminals only are spring cage.

③ For electrical life contactor application data, see Volume 5—Motor Control and Protection, CA08100006E, Tab 1.

④ For 180–225A, use 2 x 3/0 AWG wire.

Full Voltage Non-Reversing Three-Pole Contactors, Frames H–R

UL General Purpose Amp Rating	UL/CSA Ratings				IEC Ratings		Maximum kW Ratings AC-3 Three-Phase Motors 50–60 Hz					Auxiliary Contacts	Catalog Number ②
	Three-Phase hp Ratings	200V	230V	460V	575V	AC-3 I _e (A)	AC-1 (40°C) I _e = I _{th} (A)	220/230V	380/400V	415V	660/690V ①		
Frame H – Electronic Coil													
250	50	60	125	150	185	337	55	90	—	140	108	2NO-2NC	XTCE185H22_
250	60	75	150	200	225	386	70	110	—	215	108	2NO-2NC	XTCE225H22_
Frame L – Standard Coil (110/120V, 230/240 Vac Coil Only)													
300	75	100	200	250	250	429	75	132	148	240	108	2NO-2NC	XTCE250L22_
350	100	125	250	300	300	490	90	160	—	195	132	2NO-2NC	XTCE300L22_
Frame L – Electronic Coil													
300	75	100	200	250	250	429	75	132	148	240	108	2NO-2NC	XTCE250L22_
350	100	125	250	300	300	490	90	160	—	195	132	2NO-2NC	XTCE300L22_
Frame M – Standard Coil (110/120V, 230/240 Vac Coil Only)													
450	125	150	300	400	400	612	125	200	240	344	132	2NO-2NC	XTCE400M22_
550	150	200	400	500	500	857	155	250	300	344	132	2NO-2NC	XTCE500M22_
Frame M – Electronic Coil													
450	125	150	300	400	400	612	125	200	240	344	132	2NO-2NC	XTCE400M22_
550	150	200	400	500	500	857	155	250	300	344	132	2NO-2NC	XTCE500M22_
Frame N – Electronic Coil													
630	200	200	400	600	580	980	185	315	348	560	600	2NO-2NC	XTCE580N22_ ③
700	200	250	500	600	650	1041	205	355	390	630	600	2NO-2NC	XTCE650N22_ ③
800	250	300	600	700	750	1102	240	400	455	720	800	2NO-2NC	XTCE750N22_ ③
850	290	350	700	860	820	1225	260	450	500	750	800	2NO-2NC	XTCE820N22_ ③
1100	350	420	850	980	1000	1225	315	560	610	1000	1000	2NO-2NC	XTCEC10N22_ ③
Frame P – Electronic Coil													
1400	—	—	—	—	—	1714	—	—	—	—	—	2NO-2NC	XTCEC14P22_ ③
Frame R – Electronic Coil													
1600	560	640	1200	1300	1600	2200	500	900	900	1600	1700	2NO-2NC	XTCEC16R22_ ③
2000	—	—	—	—	—	2450	—	—	—	—	—	2NO-2NC	XTCEC20R22_ ③

Contactor Application Data

Catalog Prefix	Electrical Life (Operations) for 10 hp, 480V (14.2A) Applications
XTCE012B	1 million
XTCE015B	1.2 million
XTCE018C	2 million

Notes

AC and DC operated contactors have a built-in suppressor circuit (Frames L–R, 185–2000A).

① For 185–500A contactors at 660/690V or 1000V: Do not reverse directly.

② Underscore (_) indicates magnet coil suffix required. See Page V9-T2-12.

③ When operating the 580–2000A XTCE contactors with frequency inverters, the suppressor on the load side must be removed. The load side suppressor must also be removed when performing a high-voltage test—see Pub51204, Pub51209.

Full Voltage Non-Reversing Three-Pole Contactors—Contact Sequence (Circuit Symbols), Standard Offering

Contactor Frame	Auxiliary Contacts	Contact Sequence
B–C	1NO	A1 1 3 5 13 A2 2 4 6 14
B–C	1NC	A1 1 3 5 21 A2 2 4 6 22
D–G	—	A1 1 3 5 A2 2 4 6
L–R	2NO-2NC	A1 1 3 5 13 21 31 43 A2 2 4 6 14 22 32 44

2.1

Motor Control and Protection

Contactors

2

Magnet Coil Suffix

Coil Voltage	Suffix Code
Frames B–F	
110V 50 Hz, 120V 60 Hz	A
220V 50 Hz, 240V 60 Hz	B
24V 50/60 Hz	T
24 Vdc	TD
415V 50 Hz, 480V 60 Hz	C
550V 50 Hz, 600V 60 Hz	D
208V 60 Hz	E
Frame G	
100–120V 50/60 Hz	A
190–240V 50/60 Hz	B
24V 50/60 Hz	T
24–27 Vdc	TD
480–500V 50/60 Hz	C











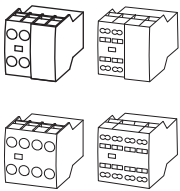

Coil Voltage	Suffix Code
Frame H	
100–120V 50/60 Hz	A
190–240V 50/60 Hz	B
480–500V 50/60 Hz	C
24–27 Vdc	TD
Frames L–M, S-Series	
110–120V 50/60 Hz	A
220–240V 50/60 Hz	B
Frame N	
110–250V 40–60 Hz/DC	A
250–500V 40–60 Hz	C
24–48 Vdc	TD
Frames P–R	
220–250V 50–60 Hz/DC	B

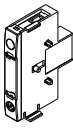
XTCR Reversing Contactor Components

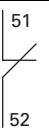
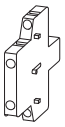
Qty.	Frame	B	C	D	F	G
2	Contactors	XTCE...B01_	XTCE...B01_	XTCE...D00_	XTCE...F00_	XTCE...G00_
2	Auxiliary contact	XTCEXFAC20	XTCEXFAC20	XTCEXFBG11	XTCEXFBG11	XTCEXFBG11
1	Mechanical interlock	XTCEXMLB	XTCEXMLC	XTCEXMLD	XTCEXMLG	XTCEXMLG
1	Reversing link kit	XTCEXRLB	XTCEXRLC	XTCEXRLD	XTCEXRLG	XTCEXRLG

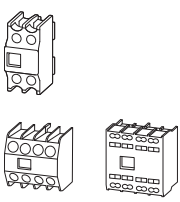
Accessories

Auxiliary Contacts—Frames B–G

		Conventional Thermal Current, Open at 60°C $I_{th} = I_{th}$, AC-1 in Amps	Poles	Contact Configuration	Circuit Symbol	Pkg. Qty.	Catalog Number—Screw Terminals
Frames B–C		Frames B–C—Front (Top) Mount ①					
	16	2	2NO		5	XTCEXFAC20	
	16	2	1NO-1NC		5	XTCEXFAC11	
	16	4	4NO		5	XTCEXFAC40	
	16	4	2NO-2NC		5	XTCEXFAC22	
Frame B		Frame B—Side Mount ①②					
	16	1	1NO		1	XTCEXSAB10	
	16	1	1NC		1	XTCEXSAB01	
Frame C		Frame C—Side Mount ①					
	10	2	1NO-1NC		1	XTCEXSAC11 ①	
Frames D–G		Frames D–G ③					
	16	2	2NO		5	XTCEXFBG20	
	16	2	1NO-1NC		5	XTCEXFBG11	
	16	4	4NO-0NC		5	XTCEXFBG40	
	16	4	2NO-2NC		5	XTCEXFBG22	

Notes

Interlocked opposing contacts, to IEC/EN 60947-5-1 Annex L (positively driven), within the auxiliary contact modules (not NO [early make] and NC [late break] contacts) and for the built-in auxiliary contacts of the XTCE007_–XTCE032_ Auxiliary break contact can be used as mirror contact to IEC/EN 60947-4-1 Annex F (not NC [late break] contact). No auxiliary contacts can be fitted between two contactors.

① Frames B–C cannot use both a side AND a top mount auxiliary contact at the same time.

② Can be mounted to the left side of contactor only.

Cannot be used in combination with front (top) mount auxiliary contacts or mechanical interlocks.

③ For Frame D, six auxiliary contacts maximum (can be a combination of side and top mount units).

Side Mount Auxiliary Contacts—Frames D–R, 40–2000A

Conventional Free Air

Thermal Current, $I_{th} = I_e$, AC-1 in Amps

Poles

Contact Configuration

Circuit Symbol

Pkg. Qty.

Catalog Number—Screw Terminals

Frames D–R

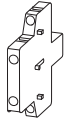

Frame D–R ①②

10	2	1NO-1NC		1	XTCEXSBN11
----	---	---------	--	---	-------------------

Frames H–R

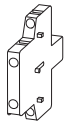

Frames H–R (Screw Mount) ②

10	2	1NO-1NC		1	XTCEXSBR11
----	---	---------	--	---	-------------------

Mechanical Interlock ③

For Use with ...

Package Qty.

Catalog Number

XTCEXMLB

XTCE007B–XTCE015B, XTCE020B

5

XTCEXMLB



XTCEXMLC

XTCE018C–XTCE032C

1

XTCEXMLC

XTCE032C–XTCE045C

XTCE040D–XTCE072D

XTCE063D–XTCE080D

1

XTCEXMLD

XTCE080F–XTCE170G

1

XTCEXMLG ④

XTCE125G–XTCE200G



XTCEXMLM

XTCE185H–XTCE570M

1

XTCEXMLM

XTCE580N–XTCEC10N

1

XTCEXMLN ④

XTCE500M–XTCE570M with XTCE500N–XTCEC10N

1

XTCEXMLNM ④

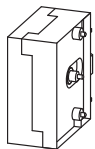

Reversing Link Kits

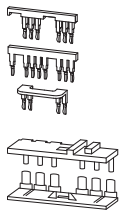

Reversing Link Kits

For Use with ...

Package Qty.

Catalog Number

XTCE007B–XTCE015B

1

XTCEXRLB ⑤

XTCE018C–XTCE032C

1

XTCEXRLC

XTCE040D–XTCE065D

1

XTCEXRLD

XTCE080F–XTCE150G

1

XTCEXRLG

Notes

- ① For Frame D, six auxiliary contacts maximum (can be a combination of side and top mount units).
- ② For Frames F–R, eight auxiliary contacts maximum (can be a combination of side and top mount units).
- ③ For two contactors with AC or DC operated magnet system which are horizontally or vertically mounted. For B–G frames, mechanical lifespan is 2.5 x 10⁶ operations and the distance between contactors is 0 mm. For L–N frames, mechanical lifespan is 5 x 10⁶ operations and no auxiliary contact can be mounted between the mechanical interlock and the contactor—the distance between contactors is 15 mm.
- ④ XTCEXMLG, XTCEXMLN and XTCEXMLNM consist of an interlock element and mounting plate.
- ⑤ Also includes interlocking bridge (XTCEXLB). The following control cables are integrated for electrical interlock:
K1M: A1–K2M: 21; K1M: 21–K2M: A1; K1M: A2–K2M: A2.

Product Overview

Monitoring Relays Selection Guide



Description	D65 Series Page V9-T2-17	D65C Series Page V9-T2-19
Approvals	cULus, CE	RoHS, cURus, cULus, CE
Features	Various combinations of protection available Compact cases for easy mounting LED indicators for quick troubleshooting	Monitors AC single-phase currents from 0.1–10 A External CT can be used to extend ranges LED indicates output relay status Choice of fixed or user-adjustable settings
Contact Data		
Configuration	SPDT or DPDT	—
Maximum allowable load	10A	Less than 5 VA
Material	—	—
Resistance	—	—
Dielectric strength	2000V	—
Coil Data		
AC	24–480 Vac	—
DC	24–120 Vdc	—
Power		
VA (Vac)	5 VA	—
Watts (Vdc)	—	—
General Data		
Ambient temperature		
Operational	–4° to 149°F (–20° to 65°C)	–20° to 131°F (–28° to 55°C)
Maximum pick-up	<= 500 milliseconds	Overcurrent: Adjustable throughout current range monitored Undercurrent: Fixed at 5% above adjustable drop-out setting
Maximum release	<= 500 milliseconds	Overcurrent: Fixed at 95% of pick-up setting for D65CE; adjustable from 50–95% of pick-up setting for D65CEK Undercurrent: Adjustable throughout current range monitored
Life		
Mechanical operations	10 million	10 million
Electrical operations	100,000	100,000

For our complete product offering, see Volume 5—Motor Control and Protection, CA08100006E.

Overload Relays Selection Guide

2

**XTIEC Miniature
Overload Relays**

**XTOB, XTOT Thermal
Overload Relays**

**XT Electronic
Overload Relays**

**Motor Insight Overload
and Monitoring Relays**

Description	XTIEC Miniature Overload Relays Page V9-T2-22	XTOB, XTOT Thermal Overload Relays Page V9-T2-23	XT Electronic Overload Relays Page V9-T2-26	Motor Insight Overload and Monitoring Relays Page V9-T2-32
Relay type	Thermal bi-metal	Thermal bi-metal	Electronic	Electronic
FLA range	0.1–12A	0.1–630A	0.1–1500A	1–540A
FLA max.:min. ratio	Approx. 1.5:1	Approx. 1.5:1	5:1	18:1 and 9:1
Trip class	10	10	Selectable 10A/10/20/30	5–30, stepped by 1's
Reset type	Selectable manual/automatic	Selectable manual/automatic	Selectable manual/automatic/remote	Selectable manual/automatic/remote
Direct connect to XT contactor	Yes, XTMC	Yes, XTCE	Yes, XTCE	—
Direct connect to DP contactor	—	—	Yes	—
Standalone mounting	—	Panel or DIN	Panel or DIN	Panel
Thermal overload protection	Yes	Yes	Yes	Yes, programmable
Jam	—	—	—	Yes, programmable
Current unbalance protection	—	—	Yes, selectable	Yes, programmable
Single-phasing	—	—	Yes, fixed level	Yes, fixed on or off
Ground fault	—	—	Yes, fixed	Yes, programmable
Phase reversal	—	—	—	Yes, programmable
Undercurrent	—	—	—	Yes, programmable
Overcurrent	—	—	—	—
Low power/high power	—	—	—	Yes, programmable
Overvoltage/undervoltage	—	—	—	Yes, programmable
Voltage unbalance	—	—	—	Yes, programmable
Current per phase and average rms	—	—	—	Yes
Current unbalance percent	—	—	Yes	Yes
Ground fault current	—	—	Yes	Yes
Voltage per phase and average rms	—	—	—	Yes
Voltage unbalance percent	—	—	—	Yes
Power/power factor	—	—	—	Yes
Thermal capacity	—	—	Yes	Yes
Frequency	—	—	Yes	Yes
Motor run hours	—	—	—	Yes
Motor starts count	—	—	—	Yes
Time to restart after fault	—	—	—	Yes
Overload status	—	—	Yes	Yes
Programmable reset timers/attempts	—	—	—	Yes
Programmable trip delays	—	—	—	Yes
Programmable auxiliary contact	—	—	—	Yes (120 Vac control-power version)
Communications with I/O	—	—	Yes (Modbus® RTU, DeviceNet™, PROFIBUS®, Modbus TCP, EtherNet/IP)	Yes (Modbus RTU, DeviceNet, PROFIBUS, Modbus TCP, EtherNet/IP)
Remote display	—	—	—	Yes (NEMA 1, 12, and 3R)
Lockable user interface or tamperproof	—	—	Yes	Yes
Alarm no-trip mode	—	—	—	Yes, for GF and line faults
Diagnostics	—	—	—	Yes, 10 fault queue

For our complete product offering, see Volume 5—Motor Control and Protection, CA08100006E.

Catalog Number Selection

D65 Series Monitoring Relays

D65 Series

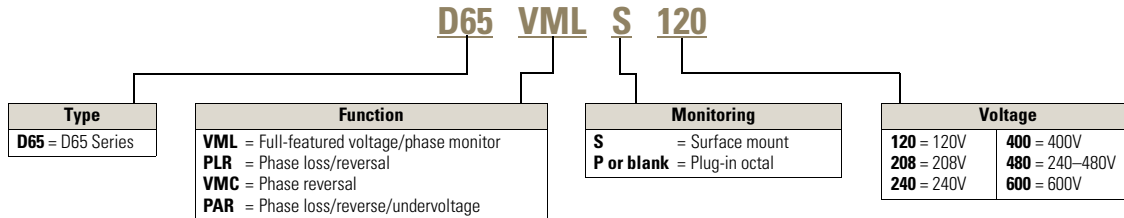

D65 Series Full-Featured Voltage/Phase Monitor

Features

- Full-featured voltage/phase monitoring relays
- Undervoltage, overvoltage, phase imbalance, phase loss (single-phasing), phase reversal
- Universal voltage range of 208–480V provides the flexibility to cover a variety of applications; 120V and 600V units also available
- Automatic or manual reset after the fault condition is corrected
- User-adjustable settings include nominal voltage, percent phase imbalance, undervoltage drop-out, time delay on undervoltage and time delay on restart after fault

Product Selection

D65VML_

D65VML Series



Style	Operating Voltage, 50/60 Hz	Catalog Number
Surface-mount (DIN rail or panel)	120V	D65VMLS120
	208–480V	D65VMLS480
	600V	D65VMLS600
Plug-in (DIN rail)	120V	D65VMLP120
	208–480V	D65VMLP480 ①
8-pin socket	—	D3PA2 ②
8-pin IP20 rated socket	—	D3PA6

D65 Series Phase Reversal Monitoring Relays

Features

- Protects against phase reversal
- One version works on 208–480V three-phase systems
- 10A SPDT output contacts

Product Selection

D65VMC_

D65VMC Series



Style	Nominal Voltage, 50/60 Hz	Catalog Number
Plug-in	120V	D65VMC120
	208–480V	D65VMC480 ①

Notes

- ① Requires a 600V rated socket when used on system voltages greater than 300V.
- ② The D3PA2 socket is rated 10A, 600V.

D65 Series Phase Loss and Reversal Monitoring Relays**Features**

2

- Protects against phase loss and phase reversal
- LED indicates both normal and fault conditions
- 10A SPDT output contacts

Product Selection**D65PLR_****D65PLR Series**

Style	Nominal Voltage, 50/60 Hz	Catalog Number
Plug-in	120V	D65PLR120
	208V	D65PLR208
	240V	D65PLR240
	400V	D65PLR400 ①
	480V	D65PLR480 ①

D65 Series Phase Loss, Reversal and Undervoltage**Features**

- Protects against phase loss, phase reversal and undervoltage
- Undervoltage setting is adjustable from 75–95% of nominal
- LED indicates both normal and fault conditions
- 10A SPDT output contacts

Product Selection**D65PAR_****D65PAR Series**

Style	Nominal Voltage, 60 Hz	Undervoltage Range	Catalog Number
Plug-in	120V	90–115V	D65PAR120
	208V	156–198V	D65PAR208
	240V	180–230V	D65PAR240
	400V	300–380V	D65PAR400 ①
	480V	360–460V	D65PAR480 ①

Note

- ① Requires a 600V rated socket when used on system voltages greater than 300V.

Catalog Number Selection

D65C Series Monitoring Relays

D65C Series

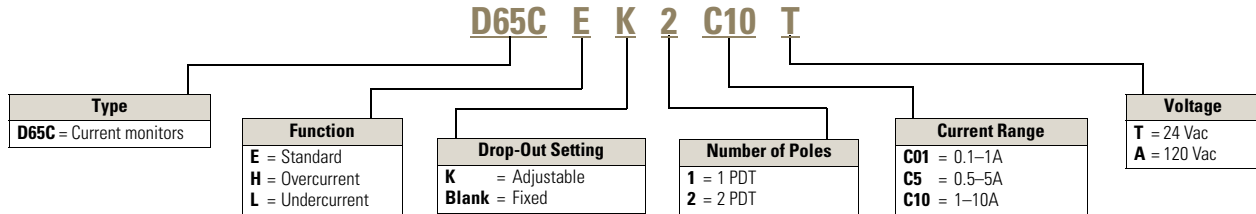

D65CE Standard Current Monitoring Relays

Features

- Monitors AC single-phase currents
- Three separate current monitoring ranges covering 0.1–10 amperes
- External CT can be used to extend ranges
- Fixed 100 ms pick-up and drop-out time delay

Product Selection

D65CE_ D65CE Series



Pick-Up Setting	Drop-Out Setting	Input Voltage	Current Range Monitored	Catalog Number
SPDT – 8-Pin Plug-In				
Adjustable	Fixed (at 95% of pick-up)	24 Vac	0.1–1A	D65CE1C01T
			0.5–5A	D65CE1C5T
			1–10A	D65CE1C10T
	120 Vac		0.1–1A	D65CE1C01A
			0.5–5A	D65CE1C5A
			1–10A	D65CE1C10A
Adjustable (50–95% of pick-up)	24 Vac		0.1–1A	D65CEK1C01T
			0.5–5A	D65CEK1C5T
			1–10A	D65CEK1C10T
	120 Vac		0.1–1A	D65CEK1C01A
			0.5–5A	D65CEK1C5A
			1–10A	D65CEK1C10A
DPDT – 11-Pin Plug-In				
Adjustable	Fixed (at 95% of pick-up)	24 Vac	0.1–1A	D65CE2C01T
			0.5–5A	D65CE2C5T
			1–10A	D65CE2C10T
	120 Vac		0.1–1A	D65CE2C01A
			0.5–5A	D65CE2C5A
			1–10A	D65CE2C10A
Adjustable (50–95% of pick-up)	24 Vac		0.1–1A	D65CEK2C01T
			0.5–5A	D65CEK2C5T
			1–10A	D65CEK2C10T
	120 Vac		0.1–1A	D65CEK2C01A
			0.5–5A	D65CEK2C5A
			1–10A	D65CEK2C10A

D65CH Series, Overcurrent Monitors

Features

- Monitors AC single-phase currents for overcurrent conditions
- Three separate current monitoring ranges covering 0.1–10 amperes
- External CT can be used to extend ranges
- Adjustable pick-up setting with either fixed or adjustable drop-out setting
- Adjustable time delay of 0.1–10 seconds on pick-up
- Fixed 100 ms time delay on drop-out
- LED indicates output

Product Selection

D65CH_

D65CH Series



Pick-Up Setting	Drop-Out Setting	Input Voltage	Current Range Monitored	Catalog Number		
SPDT—8-Pin Plug-In						
Adjustable	Fixed (at 95% of pick-up)	24 Vac	0.1–1A	D65CH1C1T		
			0.5–5A	D65CH1C5T		
			1–10A	D65CH1C10T		
	Adjustable (50–95% of pick-up)	120 Vac	24 Vac	0.1–1A	D65CH1C1A	
				0.5–5A	D65CH1C5A	
				1–10A	D65CH1C10A	
		120 Vac	24 Vac	0.1–1A	D65CHK1C1T	
				0.5–5A	D65CHK1C5T	
				1–10A	D65CHK1C10T	
Adjustable (50–95% of pick-up)	120 Vac	24 Vac	0.1–1A	D65CHK1C1A		
			0.5–5A	D65CHK1C5A		
			1–10A	D65CHK1C10A		
	DPDT—11-Pin Plug-In					
	Adjustable	Fixed (at 95% of pick-up)	24 Vac	0.1–1A	D65CH2C1T	
				0.5–5A	D65CH2C5T	
				1–10A	D65CH2C10T	
			120 Vac	24 Vac	0.1–1A	D65CH2C1A
					0.5–5A	D65CH2C5A
1–10A					D65CH2C10A	
Adjustable (50–95% of pick-up)		120 Vac	24 Vac	0.1–1A	D65CHK2C1T	
				0.5–5A	D65CHK2C5T	
				1–10A	D65CHK2C10T	
		120 Vac	24 Vac	0.1–1A	D65CHK2C1A	
				0.5–5A	D65CHK2C5A	
				1–10A	D65CHK2C10A	

D65CL Series, Undercurrent Monitoring Relays

Features

- Monitors AC single-phase currents for undercurrent conditions
- Three separate current monitoring ranges covering 0.1–10 amperes
- External CT can be used to extend ranges
- Adjustable drop-out setting with fixed pick-up setting
- Adjustable time delay of 0.1–10 seconds on drop-out
- Fixed 100 ms time delay on pick-up

Product Selection

D65CL_

D65CL Series



Pick-Up Setting	Drop-Out Setting	Input Voltage	Current Range Monitored	Catalog Number
SPDT – 8-Pin Plug-In				
Adjustable	Fixed (at 5% of drop-out)	24 Vac	0.1–1A	D65CL1C1T
			0.5–5A	D65CL1C5T
			1–10A	D65CL1C10T
		120 Vac	0.1–1A	D65CL1C1A
			0.5–5A	D65CL1C5A
			1–10A	D65CL1C10A
SPDT – 11-Pin Plug-In				
Adjustable	Fixed (at 5% of drop-out)	24 Vac	0.1–1A	D65CL2C1T
			0.5–5A	D65CL2C5T
			1–10A	D65CL210T
		120 Vac	0.1–1A	D65CL2C1A
			0.5–5A	D65CL2C5A
			1–10A	D65CL2C10A

XTIEC Miniature Overload Relays

2



Features

- Trip class 10A
- Ambient temperature compensated -5° to 50°C (23° to 122°F)
- Selectable manual/automatic reset
- 1NO-1NC auxiliary contact as standard
- Direct mount with XTMC contactors

Catalog Number Selection

XTIEC Miniature Overload Relays

Miniature Overload Relays

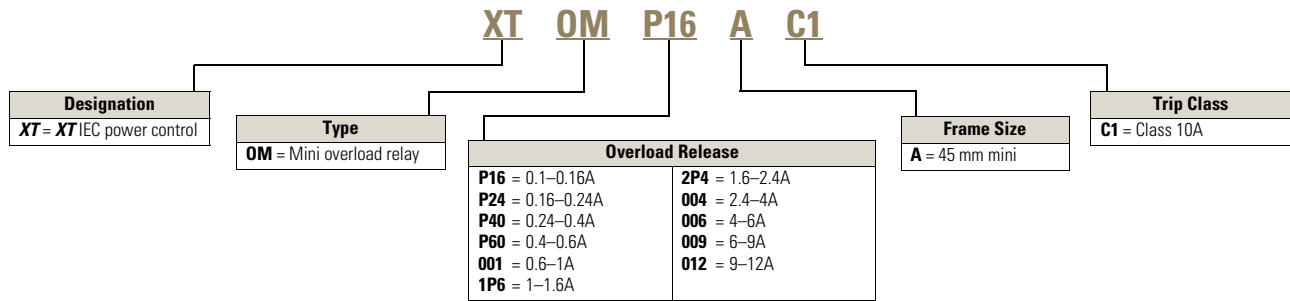

Product Selection

Miniature Overload Relays ①②

Overload Release It	Trip Class	Contact Sequence	Contact Configuration	Short Circuit Protection (A)		Circuit Breaker	CEC/NEC Fuse	Catalog Number
				Type 1 Coordination, gG/gL	Type 2 Coordination, gG/gL			
0.1–0.16A	10A	97 95	1NO-1NC	20	0.5	15	—	XTOMP16AC1
0.16–0.24A				20	1	15	—	XTOMP24AC1
0.24–0.4A		2 4 6 98 96		20	2	15	—	XTOMP40AC1
0.4–0.6A				20	2	15	—	XTOMP60AC1
0.6–1A				20	4	15	3	XTOM001AC1
1–1.6A				20	6	15	6	XTOM1P6AC1
1.6–2.4A				20	6	15	6	XTOM2P4AC1
2.4–4A				20	10	15	15	XTOM004AC1
4–6A				20	10	15	20	XTOM006AC1
6–9A				20	10	15	35	XTOM009AC1
9–12A				—	—	—	45	XTOM012AC1

Notes

- ① Short-circuit protection: Observe the maximum permissible fuse of the contactor with direct device mounting. See MN03402002E for more information.
 ② When fitted directly to the contactor, a clearance of at least 5 mm is required between the overload relays.

XTOB, XTOT Thermal Overload Relays



Features

- Direct mount to **XT** contactors or separate mount
- Class 10A
- Up to 630A

Catalog Number Selection

XTOB, XTOT Thermal Overload Relays

Thermal Overload Relays

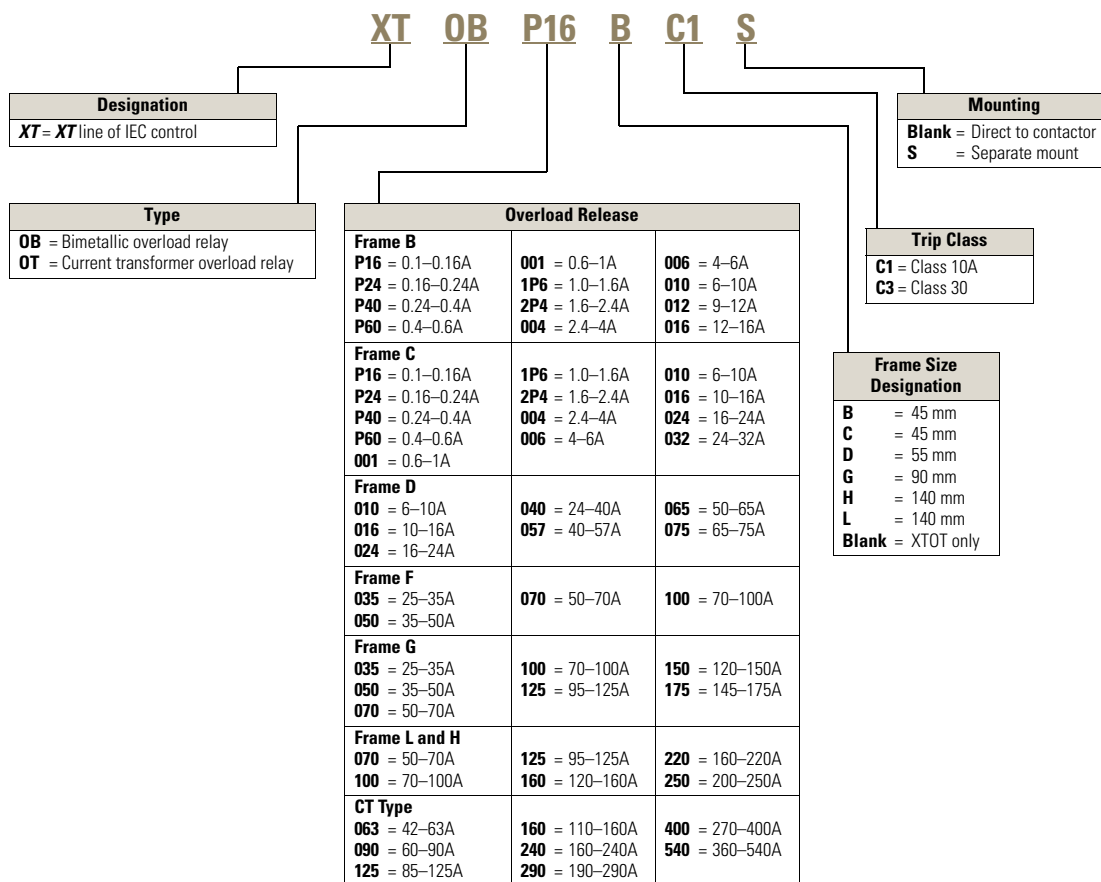

Product Selection

2

XTOB, XTOT Thermal Overload Relays

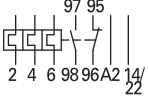
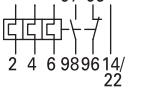
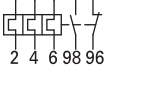
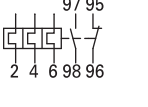
Overload Releases, I _r	Contact Sequence	Contact Configuration	For Use with Contactor Ampere Range	Short-Circuit Protection (A)		Catalog Number
				Maximum Circuit Breaker	CEC/NEC Fuse	
Frame B—Direct Mount to XTCE...B Contactor						
0.1–0.165		1NO-1NC	7–15A	25	3	XTOBP16BC1
0.16–0.24			7–15A	25	3	XTOBP24BC1
0.24–0.4			7–15A	25	3	XTOBP40BC1
0.4–0.6			7–15A	25	3	XTOBP60BC1
0.6–1			7–15A	25	3	XTOB001BC1
1–1.6			7–15A	25	6	XTOB1P6BC1
1.6–2.4			7–15A	25	6	XTOB2P4BC1
2.4–4			7–15A	25	15	XTOB004BC1
4–6			7–15A	25	20	XTOB006BC1
6–10			7–15A	25	35	XTOB010BC1
9–12			9–15A	25	45	XTOB012BC1
12–16			12–15A	30	45	XTOB016BC1
Frame C—Direct Mount to XTCE...C Contactor						
0.6–1		1NO-1NC	18–32A	25	3	XTOB001CC1
1–1.6			18–32A	25	6	XTOB1P6CC1
1.6–2.4			18–32A	25	6	XTOB2P4CC1
2.4–4			18–32A	25	15	XTOB004CC1
4–6			18–32A	25	20	XTOB006CC1
6–10			18–32A	25	25	XTOB010CC1
10–16			18–32A	30	25	XTOB016CC1
16–24			18–32A	30	25	XTOB024CC1
24–32			25–32A	30	25	XTOB032CC1
Frame D—Direct Mount to XTCE...D Contactor						
6–10		1NO-1NC	40–72A	25	25	XTOB010DC1
10–16			40–72A	25	25	XTOB016DC1
16–24			40–72A	30	25	XTOB024DC1
24–40			40–72A	125	125	XTOB040DC1
40–57			50–72A	150	150	XTOB057DC1
50–65			65–72A	150	200	XTOB065DC1
65–75			72A	150	200	XTOB075DC1
Frames F–G—Direct Mount to XTCE...F or XTCE...G Contactor						
35–50		1NO-1NC	80–170A	150	200	XTOB050GC1
50–70			80–170A	150	200	XTOB070GC1
70–100			80–170A	400	400	XTOB100GC1
95–125			80–170A	500	400	XTOB125GC1
120–150			80–170A	600	600	XTOB150GC1
145–175			150–170A	600	600	XTOB175GC1

Notes

Short circuit protection: Observe the maximum permissible fuse of the contactor with direct device mounting. See MN03402001E for more information on overload relays for Frames B–G.

Trip Class: 10A

Suitable for protection of EEx e-motors. EC prototype test certificate available upon request.

Observe manuals MN03402001E and MN03407001E. See documentation—manuals for overload monitoring of EEx e-motors.

XTOB, XTOT Thermal Overload Relays, continued

Overload Releases, I _r	Contact Sequence	Contact Configuration	For Use with Contactor Ampere Range	Short-Circuit Protection (A)		Catalog Number
				Maximum Circuit Breaker	CEC/NEC Fuse	
Frames F–G—Separate Mount						
35–50		1NO-1NC	80–170A	150	200	XTOB050GC1S
50–70			80–170A	150	200	XTOB070GC1S
70–100			80–170A	400	400	XTOB100GC1S
95–125			80–170A	500	400	XTOB125GC1S
120–150			80–170A	600	600	XTOB150GC1S
145–175			150–170A	600	600	XTOB175GC1S
Frame H—Separate Mount						
50–70		1NO-1NC	185–250A	150	200	XTOB070HC1
70–100			185–250A	400	400	XTOB100HC1
95–125			185–250A	500	400	XTOB125HC1
120–160			185–250A	600	600	XTOB160HC1
160–220			185–250A	600	800	XTOB220HC1
200–250			225–250A	600	700	XTOB250HC1
Frame L—Direct Mount to XTC (E or S)...L or Separate Mount						
50–70		1NO-1NC	185–250A	150	200	XTOB070LC1
70–100			185–250A	400	400	XTOB100LC1
95–125			185–250A	500	400	XTOB125LC1
120–160			185–250A	600	600	XTOB160LC1
160–220			185–250A	800	800	XTOB220LC1
200–250			225–250A	600	700	XTOB250LC1

Current Transformer Operated Overload Relay

Overload Releases, I _r	Contact Sequence	Contact Configuration	For Use with Contactor Ampere Range	Short-Circuit Protection (A)		Catalog Number
				Maximum Circuit Breaker	CEC/NEC Fuse	
Frames M–N—Separate Mount						
160–240		1NO-1NC	300–500A	600	700	XTOT240C3S
190–290			300–500A	600	700	XTOT290C3S
270–400			300–500A	1000	1000	XTOT400C3S
360–540			500A	600	1000	XTOT540C3S
420–630			630A	600	1000	XTOT630C3S

Accessories

Adapter



DIN-Rail or Panel-Mount Adapter, Frames C–D ①

For Use With...	Package Qty.	Catalog Number
XTOB...CC1	5	XTOBXDINC
XTOB...DC1	2	XTOBXDIND

Notes

Short circuit protection: Observe the maximum permissible fuse of the contactor with direct device mounting. See MN03402001E for more information on overload relays for Frames B–G.

Trip Class: 10A

Suitable for protection of EEx e-motors. EC prototype test certificate available upon request.

Observe manuals MN03402001E and MN03407001E. See documentation—manuals for overload monitoring of EEx e-motors.

① Can be snap fitted on a top hat rail (DIN rail) or can be screw fitted.

XT Electronic Overload Relays

2



Features

- Direct mount to **XT** contactors or separate mount
- Standard version: selectable trip class (10A, 10, 20, 30) with selectable manual or auto reset
- Broad 5:1 FLA range
- Self-powered design, will accept AC voltages from 12–690V 50/60 Hz
- Electrically isolated 1NO-1NC contacts (push-to-test)
- FLA range of 0.1–1500A

Catalog Number Selection

XT Electronic Overload Relays

XT Electronic Overload Relay—IEC ①

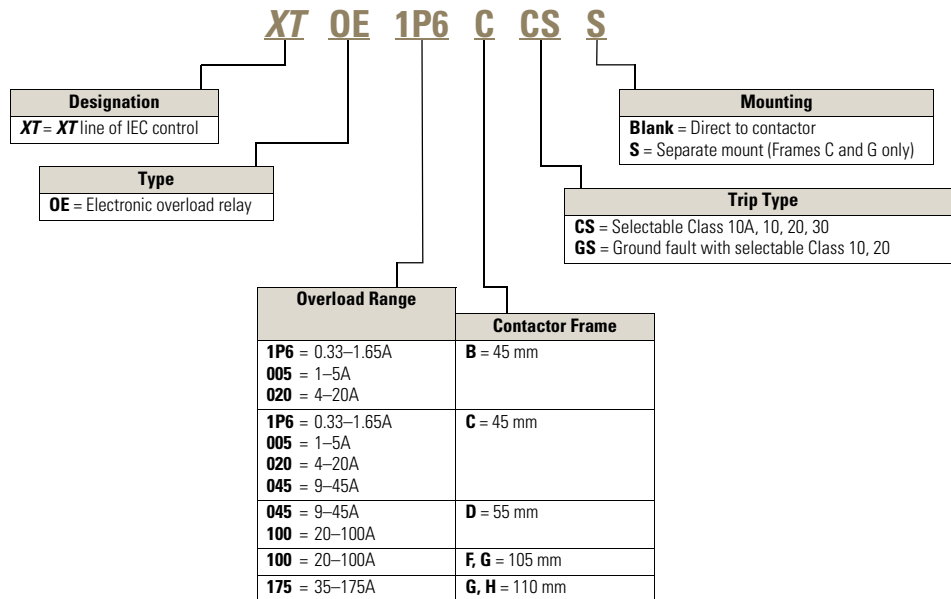

Note

① See Page V9-T2-27 for Product Selection.

Product Selection

XT Electronic Overload Relays

45 mm XT for Direct Mount



XT Electronic Overload Relays for Direct Mount to XT Contactors

For Use with XT Contactor Frame	For Use with Contactor	Overload Range (Amps)	Contact Sequence	Frame Size	Auxiliary Contact Configuration	Type	Catalog Number
B	XTCE007B..., XTCE009B..., XTCE012B..., XTCE015B...	0.33–1.65		45 mm	NO-NC	ZEB12-1,65	XTOE1P6BCS
		1–5				ZEB12-5	XTOE005BCS
		4–20				ZEB12-20	XTOE020BCS
C	XTCE018C..., XTCE025C..., XTCE032C	0.33–1.65		45 mm	NO-NC	ZEB32-1,65	XTOE1P6CCS
		1–5				ZEB32-5	XTOE005CCS
		4–20				ZEB32-20	XTOE020CCS
		9–45				ZEB32-45	XTOE045CCS
D	XTCE040D..., XTCE050D..., XTCE065D..., XTCE072D...	9–45		45 mm	NO-NC	ZEB65-45	XTOE045DCS
		20–100		55 mm		ZEB65-100	XTOE100DCS
F	XTCE080F..., XTCE095F...	20–100		55 mm	NO-NC	ZEB150-100	XTOE100GCS
G	XTCE115G..., XTCE150G..., XTCE170G...	20–100		55 mm	NO-NC	ZEB150-100	XTOE100GCS
		35–175		110 mm		ZEB150-175	XTOE175GCS
H	XTCE185H...	35–175		110 mm	NO-NC	ZEB225-175	XTOE175HCS

45 mm XT for Direct Mount with Ground Fault



XT Electronic Overload Relays with Ground Fault for Direct Mount to XT Contactors

For Use with XT Contactor Frame	For Use with Contactor	Overload Range (Amps)	Contact Sequence	Frame Size	Auxiliary Contact Configuration	Type	Catalog Number
B	XTCE007B..., XTCE009B..., XTCE012B..., XTCE015B...	0.33–1.65		45 mm	NO-NC	ZEB12-1,65-GF	XTOE1P6BGS
		1–5				ZEB12-5-GF	XTOE005BGS
		4–20				ZEB12-20-GF	XTOE020BGS
C	XTCE018C..., XTCE025C..., XTCE032C	0.33–1.65		45 mm	NO-NC	ZEB32-1,65-GF	XTOE1P6CGS
		1–5				ZEB32-5-GF	XTOE005CGS
		4–20				ZEB32-20-GF	XTOE020CGS
		9–45				ZEB32-45-GF	XTOE045CGS
D	XTCE040D..., XTCE050D..., XTCE065D..., XTCE072D...	9–45		45 mm	NO-NC	ZEB65-45-GF	XTOE045DGS
		20–100		55 mm		ZEB65-100-GF	XTOE100DGS
F	XTCE080F..., XTCE095F...	20–100		55 mm	NO-NC	ZEB150-100-GF	XTOE100GGS
G	XTCE115G..., XTCE150G..., XTCE170G...	20–100		55 mm	NO-NC	ZEB150-100-GF	XTOE100GGS
		35–175		110 mm		ZEB150-175-GF	XTOE175GGS
H	XTCE185H...	35–175		110 mm	NO-NC	ZEB225-175-GF	XTOE175HGS

2.2

Motor Control and Protection

Motor Protection and Monitoring Relays

2

1-5A OL with CTs



XT Electronic Overload Relays for use with Large Frame XT Contactors (L-R)

Use CTs and 1-5A **XT** overload relay. CT kit does not include overload relay (order separately).

XT Contactor Frame	For Use with IEC Contactor Amp Range (AC-3)	CT Range (Amps)	Description	CT Kit Catalog Number	Terminal Size	Overload Relay Catalog Number	Overload Relay with Ground Fault Catalog Number
L, M	185–500A	60-300	300: 5 panel-mount CT kit with integrated lugs	ZEB-XCT300	750 kcmil (2) 250 kcmil 3/0 Cu/Al	XTOE005CCSS	XTOE005CGSS
M, N	300–820A	120-600	600: 5 panel-mount CT kit with integrated, pass through holes	ZEB-XCT600	(2) 750 kcmil 3/0 Cu/Al	XTOE005CCSS	XTOE005CGSS
N	580–1000A	200-1000	1000: 5 panel-mount CT kit with integrated, pass through holes	ZEB-XCT1000	(3) 750 kcmil 3/0 Cu/Al	XTOE005CCSS	XTOE005CGSS
R	1600A	300-1500	1500: 5 panel-mount CT kit with integrated, pass through holes	ZEB-XCT1500	(4) 750 kcmil 1/0 Cu/Al	XTOE005CCSS	XTOE005CGSS

45 mm XT for Separate Mount



XT Electronic Overload Relays for Separate Mount

Overload Range (Amps)	Frame Size	Contact Sequence	Type	Overload Relay Catalog Number	Overload Relay with Ground Fault Catalog Number
Overload Relay					
0.33–1.65	45 mm	1 3 5 97 95	ZEB32-1,65/KK	XTOE1P6CCSS	XTOE1P6CGSS
1–5			ZEB32-5/KK	XTOE005CCSS	XTOE005CGSS
4–20		2 4 6 98 96	ZEB32-20/KK	XTOE020CCSS	XTOE020CGSS
9–45			ZEB32-45/KK	XTOE045CCSS	XTOE045CGSS
20–100	55 mm		ZEB150-100/KK	XTOE100GCSS	XTOE100GGSS
35–175	110 mm		ZEB150-175/KK	XTOE175GCSS	XTOE175GGSS

XT Electronic Overload Relay for Pass-Through Design



Pass-through design does not include any lugs to land wires. Terminate motor leads directly on contactor.

Overload Range (Amps)	Frame Size	Contact Sequence	Type	Overload Relay Catalog Number	Overload Relay with Ground Fault Catalog Number
35–175	110 mm	1 3 5 97 95	ZEB150-175/PT	XTOE175GCSP	XTOE175GGSP

Accessories

CT Kits

Accessories

	Description	Catalog Number
Safety Cover 	Safety Cover Clear Lexan cover that mounts on top of the FLA dial and DIP switches when closed.	ZEB-XSC
Reset Bar 	Reset Bar Assembles to the top of the overload to provide a larger target area for door mounted reset operators.	ZEB-XRB
Remote Reset 	Remote Reset Remote reset module (24 Vdc) ① Remote reset module (120 Vac) ① Remote reset module (24 Vac) ①	C440-XCOM ZEB-XRR-120 ZEB-XRR-24

Communication

The C440 is provided with two levels of communication capability.

Basic Communication via Expansion Module—Monitoring Only

Basic communication on the C440 is accomplished using an expansion module. The expansion module plugs into the expansion bay on the C440 overload relay, enabling communications with the overload via their Modbus RTU (RS-485) network. No additional parts are required. See figure below.



Basic Communication—Modbus

Advanced Communication—Monitoring and Control

C440 also has the ability to communicate on industrial protocols such as DeviceNet, PROFIBUS, Modbus RTU and Modbus TCP, and Ethernet (planned) while providing control capability using I/O.

An expansion module (mentioned earlier) combined with a communication adapter and a communication module allows easy integration onto the customer's network. See figure below.



Advanced Communication—Communication Adapter with Communication Module

Advanced Communication—Communication Module

The communication adapter comes standard with four inputs and two outputs (24 Vdc or 120 Vac) while providing the customer with flexible mounting options (DIN rail or panel). See figure below,

Note

① Customer can wire remote mounted button to reset module (that is, 22 mm pushbutton, catalog number M22-D-B-GB14-K10).

2.2

Motor Control and Protection



Motor Protection and Monitoring Relays

2

The following information can be viewed using the communication option:

- Motor status—running, stopped, tripped or resetting
- Individual rms phase currents (A, B, C)
- Average of three-phase rms current
- Percent thermal capacity
- Fault codes (only available prior to reset)
- Percent phase unbalance
- Ground fault current and percent
- Overload relay settings—trip class, DIP switch selections, reset selections
- Modbus address (can be set over the network)

Communication Accessories

	Description	Catalog Number
Expansion Module	Expansion module (Remote Reset/Modbus RTU, RS-485 Communication)	C440-XCOM
		
Communication Adapter	Communication adapter kit (DIN C Panel mounted adapter, required for advance communication option)	C440-COM-ADP
		
	DeviceNet communication module kit—120V I/O (consists of C440-XCOM + C441K + C440-COM-ADP)	C440-DN-120
	DeviceNet communication module kit—24 Vdc I/O (consists of C440-XCOM + C441L + C440-COM-ADP)	C440-DN-24
	PROFIBUS communication module kit—120V I/O (consists of C440-XCOM + C441S + C440-COM-ADP)	C440-DP-120
	PROFIBUS communication module kit—24V I/O (consists of C440-XCOM + C441Q + C440-COM-ADP)	C440-DP-24
	Modbus communication module kit—120V I/O (consists of C440-XCOM + C441N + C440-COM-ADP)	C440-MOD-120
	Modbus communication module kit—24 Vdc I/O (consists of C440-XCOM + C441P + C440-COM-ADP)	C440-MOD-24
	Modbus TCP / EtherNet/IP communication module kit—120V I/O (consists of C440-XCOM + C441U)	C440-ET-120
	Modbus TCP / EtherNet/IP communication module kit—24V I/O (consists of C440-XCOM + C441V)	C440-ET-24

Short Circuit Ratings (North America CSA, cUL)

Changes to UL 508A and NEC in recent years have brought a focus to control panel safety with regard to short-circuit current ratings (SCCR). Eaton's C440 electronic overload relays combined with **XT** series IEC and Freedom Series NEMA contactors provide a wide variety of SCCR solutions needed for a variety of applications. The SCCR data in this document reflects the latest information as of April 2010.

C440/XT Standalone Overload Relays (XT, C440)

Overload FLA Range	Maximum Operating Voltage	Standard-Fault Short Circuit Data			High-Fault Short Circuit Data Fuses (RK5, J, CC)			Thermal-Magnetic Circuit Breakers		
		600V (kA)	Maximum Fuse Size (A) (RK5)	Maximum Breaker Size (A)	480V (kA)	600V (kA)	Maximum Fuse Size	480V (kA)	600V (kA)	Maximum Breaker Size
0.33–1.65A	600 Vac	1	6	15	—	—	—	—	—	—
1–5A	600 Vac	5	20	20	100	100	30	100	35	20
4–20A	600 Vac	5	80	80	100	100	100	100	35	80
9–45A	600 Vac	5	175	175	100	100	100	100	35	100/175 (480/600)
20–100A	600 Vac	10	400	400	100	100	200	150	35	250/400 (480/600)
28–140A	600 Vac	10	450	500	100	100	400	100	65	400
35–175A	690 Vac	10	500 (gG)	350 (690 Vac) 320 (415 Vac)	100	100	500 (gG)	100 (415 Vac)	—	350 (LGC3350) 320 (N2MH3)

IEC XT Starters with XT Electronic Overload Relays

Contactor Frame Size	Maximum Operating Voltage	High-Fault Short Circuit Data Fuses (RK5, J, CC)		Maximum Fuse Size	Thermal-Magnetic Circuit Breakers		
		480V	600V		480V	600V	Maximum Breaker Size
B	1–5A	100	100	30	—	—	—
	4–20A	100	100	30	—	—	—
C	1–5A	100	100	60	—	—	—
	4–20A	100	100	60	—	—	—
	9–45A	100	100	60	—	—	—
D	9–45A	100	100	200	65	35	175
	20–100A	100	100	200	65	35	175
F	20–100A	100	100	200	65	65	350
G	20–100A	100	100	200	65	65	350
	35–175A	100	100	400	65	30	250 (480 Vac) 350 (600 Vac)
H	35–175A	100	100	400	65	30	400

Motor Insight Overload and Monitoring Relays

2



Features

- Power, voltage and current monitoring, ground fault, flexible communications, motor and line protection in a single package
- Monitor energy consumption at individual loads to avoid peak demand charges
- Protect pumps from dead-head or starved conditions
- 0–660V, 1–540A with two relays
- Remote display allows for configuration without opening the panel, providing additional operator safety

Catalog Number Selection

Motor Insight Overload and Monitoring Relays

Motor Insight Overload Relays

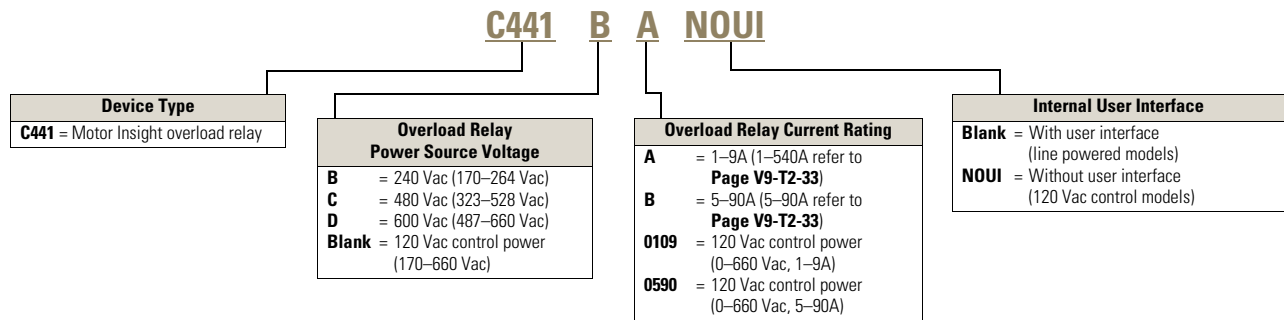

Motor Insight Overload Relays—Communications Modules and Accessory Types

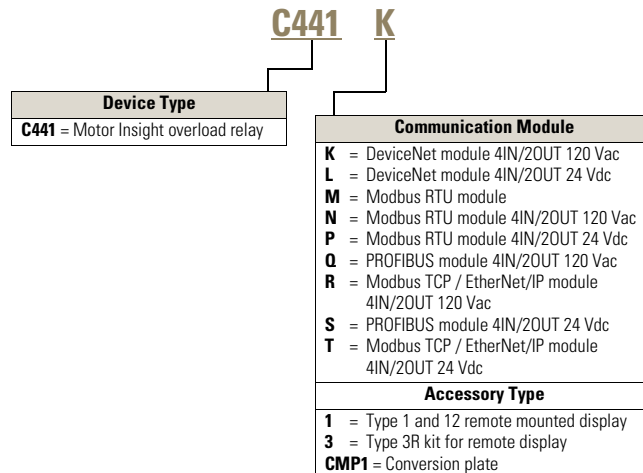

Product Selection

Motor Insight



Motor Insight

Power Source	Monitoring Range	Current Range	Catalog Number
240 Vac (170–264)	170–264 Vac	1–9A	C441BA
		5–90A	C441BB
480 Vac (323–528)	323–528 Vac	1–9A	C441CA
		5–90A	C441CB
600 Vac (489–660)	489–660 Vac	1–9A	C441DA
		5–90A	C441DB
120 Vac (93.5–132)	170–660 Vac	1–9A	C4410109NOUI
		5–90A	C4410590NOUI

Motor Insight CT Multiplier and Wire Wrap Schedule

Catalog Number ^①	Motor FLA	Number of Loops	Number of Conductors Through CT Primary	CT Multiplier Setting	External CT Kit Catalog Number ^②
Current Range: 5–90A					
C441_B and C4410590NOUI	5–22.5A	3	4	4	—
	6.67–30A	2	3	3	—
	10–45A	1	2	2	—
	20–90A	0	1	1	—
Current Range: 1–9A					
C441_A and C4410109NOUI	1–5A	1	2	2	—
	2–9A	0	1	1	—
	60–135A	0	1	150–(150:5)	C441CTKIT150
	120–270A	0	1	300–(300:5)	C441CTKIT300
	240–540A	0	1	600–(600:5)	C441CTKIT600

Notes

① Underscore indicates Operating Voltage Code required.
Operating Voltage Codes:

Code	Voltage
B	240 Vac
C	480 Vac
D	600 Vac
<empty>	120 Vac Control Power

② Any manufacturer's CTs may be used.

Modbus Communication Module

Description	I/O	Catalog Number
Modbus communication module	None	C441M
Modbus communication module 4IN/2OUT	120 Vac	C441N
Modbus communication module 4IN/2OUT	240 Vdc	C441P

PROFIBUS Communication Module

Description	I/O	Catalog Number
PROFIBUS communication module 4IN/2OUT	120 Vac	C441S
PROFIBUS communication module 4IN/2OUT	24 Vdc	C441Q

DeviceNet Modules



Description	I/O	Catalog Number
DeviceNet communication module	120 Vac	C441K
DeviceNet communication module	24 Vdc	C441L

Ethernet Communication Module

Description	I/O	Catalog Number
Modbus TCP / EtherNet/IP communication module 4IN/2OUT	120 Vac	C441R
Modbus TCP / EtherNet/IP communication module 4IN/2OUT	24 Vdc	C441T

Accessories

Motor Insight

	Description	Catalog Number
Remote Display	Remote display Type 1	C4411
		
Kit for Remote display	Type 3R kit for remote display (remote display not included)	C4413
		
	Adaptive mounting plate	C441CMP1

Communication Cables

The Remote Display requires a communication cable to connect to the Motor Insight overload relay.

Communication Cable Lengths

Length in Inches (meters)	Catalog Number
9.8 (0.25)	D77E-QPIP25
39.4 (1.0)	D77E-QPIP100
78.7 (2.0)	D77E-QPIP200
118.1 (3.0)	D77E-QPIP300

Note

① Underscore indicates operating voltage code required.

2.3

Motor Control and Protection

Manual Motor Protectors and Controllers

Product Overview

2

Manual Motor Protectors and Controllers Selection Guide



Description	XTPB Pushbutton Manual Motor Protectors	XTPR Rotary Manual Motor Protectors	XTSC Manual Motor Controllers	XTFC Combination Motor Controllers
	Page V9-T2-37	Page V9-T2-37	Page V9-T2-41	Page V9-T2-41
Operator style	Pushbutton	Rotary	Rotary	Rotary
Components	Manual motor protector	Manual motor protector	Manual motor protector contactor connector kit	Manual motor protector contactor connector kit line side adapter
UL 508 Type E	—	Yes, with line side adapter	—	—
UL 508 Type F	—	—	—	Yes
Branch motor circuit functions	Disconnect	Disconnect	Disconnect	Disconnect
	Controller (manual)	Controller (manual)	Controller (manual and remote)	Controller (manual and remote)
	Short circuit protection	Short circuit protection	Short circuit protection	Short circuit protection
	Motor overload protection	Motor overload protection	Motor overload protection	Motor overload protection
FLA range	0.1–25A	0.1–65A	0.1–65A	0.1–65A

XTIEC Manual Motor Protectors



Features

- ON/OFF rotary handle with lockout provision
- Class 10 overload protection
- Motor applications from 0.1–63A
- Built-in heater and magnetic trip elements to protect the motor
- Adjustment dial for setting motor FLA
- XTPR Rotary MMP with a lineside adapter is rated for UL 508 Type E

Catalog Number Selection

XTIEC Manual Motor Protectors

Manual Motor Protectors

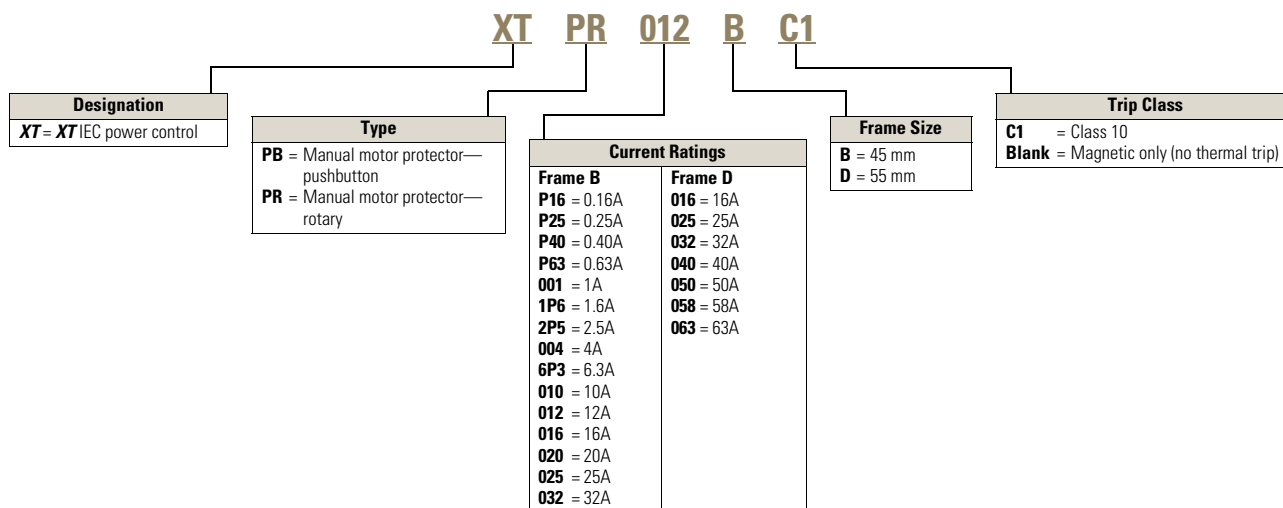

Product Selection

2

XTPB Pushbutton Manual Motor Protectors—Global and North American Ratings

Motor Protective Device with Thermal and Magnetic Trip

Note: Service Factor (SF)—Setting I_r of current scale in dependence of load factor:

SF = 1.15 → $I_r = 1 \times I_n \text{ mot}$

SF = 1 → $I_r = 0.9 \times I_n \text{ mot}$

Rated Uninterrupted Current— $I_u = I_e$ (Amps)	FLA Adjustment Range/Overload Release— I_r (A)	Short Circuit Release— I_{rm} (A)	Maximum Motor Ratings ①						Maximum hp Rating—P (hp) UL 508/CSA C 22.2 No. 14 Three-Phase				Screw Terminals— Catalog Number
			Maximum kW Rating AC-3—P (kW) Three-Phase			Maximum hp Rating—P (hp) UL 508/CSA C 22.2 No. 14 Three-Phase			200V	240V	480V	600V	
Frame B													
0.16	0.1–0.16	2.2	—	—	—	—	0.06	②	②	②	②		XTPBP16BC1
0.25	0.16–0.25	3.5	—	0.06	0.06	0.06	0.12	②	②	②	②		XTPBP25BC1
0.4	0.25–0.4	5.6	0.06	0.09	0.12	0.12	0.18	②	②	②	②		XTPBP40BC1
0.63	0.4–0.63	8.8	0.09	0.12	0.18	0.25	0.25	②	②	②	②		XTPBP63BC1
1	0.63–1	14	0.12	0.25	0.25	0.37	0.55	②	②	1/2	1/2		XTPB001BC1
1.6	1–1.6	22	0.25	0.55	0.55	0.75	1.1	②	②	3/4	1		XTPB1P6BC1
2.5	1.6–2.5	35	0.37	0.75	1.1	1.1	1.5	1/2	1/2	1	1-1/2		XTPB2P5BC1
4	2.5–4	56	0.75	1.5	1.5	2.2	3	1	1	2	3		XTPB004BC1
6.3	4–6.3	88	1.1	2.2	3	3	4	1-1/2	1-1/2	3	5		XTPB6P3BC1
10	6.3–10	140	2.2	4	4	4	7.5	3	3	7-1/2	10		XTPB010BC1
12	8–12	168	3	5.5	5.5	5.5	11	3	3	7-1/2	10		XTPB012BC1
16	10–16	224	4	7.5	9	9	12.5	3	5	10	10		XTPB016BC1
20	16–20	280	5.5	9	11	12.5	15	5	5	10	15		XTPB020BC1
25	20–25	350	5.5	12.5	12.5	15	22	5	7-1/2	15	20		XTPB025BC1

Notes

① Select manual motor protectors by full load amperes. Maximum motor ratings (kW, hp) are for reference only.

② In this range, calculate motor rating according to rated current. Specified values to NEC® 430.6(A)(1).

XTPR Rotary Manual Motor Protectors with Screw Terminals—Global Ratings and North American Ratings

Motor Protective Device with Thermal and Magnetic Trip

Note: Service Factor (SF)—Setting I_r of current scale in dependence of load factor:

$$SF = 1.15 \rightarrow I_r = 1 \times I_n \text{ mot}$$

$$SF = 1 \rightarrow I_r = 0.9 \times I_n \text{ mot}$$

Rated Uninterrupted Current— $I_u = I_e$ (Amps)	FLA Adjustment Range/Overload Release— I_r (A)	Short Circuit Release— I_{rm} (A)	Maximum Motor Ratings ①					Maximum hp Rating—P (hp) UL 508/CSA C 22.2 No. 14 Three-Phase				Screw Terminals— Catalog Number ③
			Maximum kW Rating AC-3—P (kW) Three-Phase	220–240V	380–415V	440V	500V	660–690V	200V	240V	480V	
Frame B												
0.16	0.1–0.16	2.2	—	—	—	—	0.06	②	②	②	②	XTPRP16BC1
0.25	0.16–0.25	3.5	—	0.06	0.06	0.06	0.12	②	②	②	②	XTPRP25BC1
0.4	0.25–0.4	5.6	0.06	0.09	0.12	0.12	0.18	②	②	②	②	XTPRP40BC1
0.63	0.4–0.63	8.8	0.09	0.12	0.18	0.25	0.25	②	②	②	②	XTPRP63BC1
1	0.63–1	14	0.12	0.25	0.25	0.37	0.55	②	②	1/2	1/2	XTPR01BC1
1.6	1–1.6	22	0.25	0.55	0.55	0.75	1.1	②	②	3/4	1	XTPR1P6BC1
2.5	1.6–2.5	35	0.37	0.75	1.1	1.1	1.5	1/2	1/2	1	1-1/2	XTPR2P5BC1
4	2.5–4	56	0.75	1.5	1.5	2.2	3	1	1	2	3	XTPR004BC1
6.3	4–6.3	88	1.1	2.2	3	3	4	1-1/2	1-1/2	3	5	XTPR6P3BC1
10	6.3–10	140	2.2	4	4	4	7.5	3	3	7-1/2	10	XTPR010BC1
12	8–12	168	3	5.5	5.5	5.5	11	3	3	7-1/2	10	XTPR012BC1
16	10–16	224	4	7.5	9	9	12.5	3	5	10	10	XTPR016BC1
20	16–20	280	5.5	9	11	12.5	15	5	5	10	15	XTPR020BC1
25	20–25	350	5.5	12.5	12.5	15	22	5	7-1/2	15	20	XTPR025BC1
32	25–32	448	7.5	15	15	22	30	7-1/2	10	25	30	XTPR032BC1
Frame D												
16	10–16	224	4	7.5	9	9	12.5	3	5	10	15	XTPR016DC1
25	16–25	350	5.5	12.5	12.5	15	22	7-1/2	7-1/2	20	25	XTPR025DC1
32	25–32	448	7.5	15	17.5	22	22	10	10	25	30	XTPR032DC1
40	32–40	560	11	20	22	24	30	10	15	30	40	XTPR040DC1
50	40–50	700	14	25	30	30	45	10	15	30	40	XTPR050DC1
58	50–58	812	17	30	37	37	55	—	—	40	—	XTPR058DC1
65	55–65	882	18.5	34	37	45	55	—	—	—	—	XTPR063DC1

Notes

- ① Select manual motor protectors by full load amperes. Maximum motor ratings (kW, hp) are for reference only.
- ② In this range, calculate motor rating according to rated current. Specified values to NEC 430.6(A)(1).
- ③ Catalog number shown comes with screw terminals. For Frame B devices up to 16A, spring cage terminals are available. For spring cage terminals on line and load sides, insert a "C" into the catalog number in the 5th position—Example: XTPRC _BC1. For spring cage terminals on the load side only, insert an "SC" into the catalog number in the 5th and 6th positions—Example: XTPRSC _BC1.

2.3

Motor Control and Protection

Manual Motor Protectors and Controllers

2

XTPR Manual Self-Protected Motor Starters—North American Ratings, UL 508 Type E ②

Motor Protective Device with Thermal and Magnetic Trip

Note: A UL 508 Type E self-protected manual combination starter (XTPR) consists of a manual motor protector (XTPR) and a UL listed line side adapter (e.g., XTPAXLSA). The Type E self-protected manual combination starter alone is a legitimate short-circuit protective device and disconnect means for the downstream motor, while the contactor has been added to provide remote operation of the motor circuit.

Rated Uninterrupted Current— $I_u = I_e$ (Amps)	FLA Adjustment Range/Overload Release— I_r (A)	Short Circuit Release— I_{rm} (A)	Maximum Motor Ratings ①				Rated Short Circuit Breaking Capacity (kA)			Line Side Adapter— Catalog Number ②	Manual Motor Protector Screw Terminals— Catalog Number
			Maximum hp Rating—P (hp) Three-Phase				240V	480–277V	600–247V		
Frame B											
0.16	0.1–0.16	2.2	③	③	1/2	1/2	50	50	50	XTPAXLSA	XTPRP16BC1
0.25	0.16–0.25	3.4	③	③	1/2	1/2	50	50	50	XTPAXLSA	XTPRP25BC1
0.4	0.25–0.4	5.6	③	③	1/2	1/2	50	50	50	XTPAXLSA	XTPRP40BC1
0.63	0.4–0.63	8.8	③	③	1/2	1/2	50	50	50	XTPAXLSA	XTPRP63BC1
1	0.63–1	14	③	③	1/2	1/2	50	50	50	XTPAXLSA	XTPR001BC1
1.6	1–1.6	22	③	③	3/4	3/4	50	50	50	XTPAXLSA	XTPR1P6BC1
2.5	1.6–2.5	35	1/2	1/2	1	1-1/2	50	50	50	XTPAXLSA	XTPR2P5BC1
4	2.5–4	56	3/4	1	2	3	50	50	50	XTPAXLSA	XTPR004BC1
6.3	4–6.3	88	1	1-1/2	3	5	50	50	50	XTPAXLSA	XTPR6P3BC1
10	6.3–11	140	3	3	7-1/2	10	50	50	50	XTPAXLSA	XTPR010BC1
12	8–12	168	3	3	7-1/2	—	42	42	—	XTPAXLSA	—
16	10–16	224	3	5	10	—	42	42	—	XTPAXLSA	XTPR016BC1
20	16–20	280	5	5	—	—	42	42	—	XTPAXLSA	XTPR020BC1
25	20–25	350	5	7-1/2	15	—	18	18	—	XTPAXLSA	XTPR025BC1
32	25–32	448	7-1/2	10	25	—	18	18	—	XTPAXLSA	XTPR032BC1
Frame D											
16	10–16	224	3	5	10	10	50	50	50	XTPAXLSAD	XTPR016DC1
25	16–25	350	7-1/2	7-1/2	20	25	50	50	50	XTPAXLSAD	XTPR025DC1
32	25–32	448	10	10	25	30	50	50	50	XTPAXLSAD	XTPR032DC1
40	32–40	560	10	10	30	40	50	50	50	XTPAXLSAD	XTPR040DC1
50	40–50	700	10	15	30	—	65	65	—	XTPAXLSAD	XTPR050DC1
58	50–58	812	15	15	40	—	65	65	—	XTPAXLSAD	XTPR058DC1
65	55–65	882	15	15	40	—	65	65	—	XTPAXLSAD	XTPR063DC1

Notes

- ① Select manual motor protectors by full load amperes. Maximum motor ratings (kW, hp) are for reference only.
- ② UL 508 Type E starters are assembled from a standard XTPR and a special incoming terminal line side adapter (XTPAXLSA or XTPAXLSAD).
- ③ In this range, calculate motor rating according to rated current. Specified values to NEC 430.6(A)(1).

XT IEC Manual and Combination Motor Controllers



Features

- ON/OFF rotary handle with lockout provision
- Class 10 overload protection
- Adjustment dial for setting motor FLA
- Built-in surge suppression on DC coils as standard
- Assembled manual motor controllers consist of manual motor protector, contactor, connector kit and 1NO-1NC auxiliary contact for MMP
- Assembled combination motor controllers consist of manual motor protector, contactor, connector kit, 1NO-1NC auxiliary contact for MMP and line side adapter
- Combination motor controllers are UL 508 Type F rated, and provide the following functions in a single device
 - Disconnect, short circuit protection, motor overload protection, motor controller

Catalog Number Selection

XT IEC Manual and Combination Motor Controllers

Manual and Combination Motor Controllers

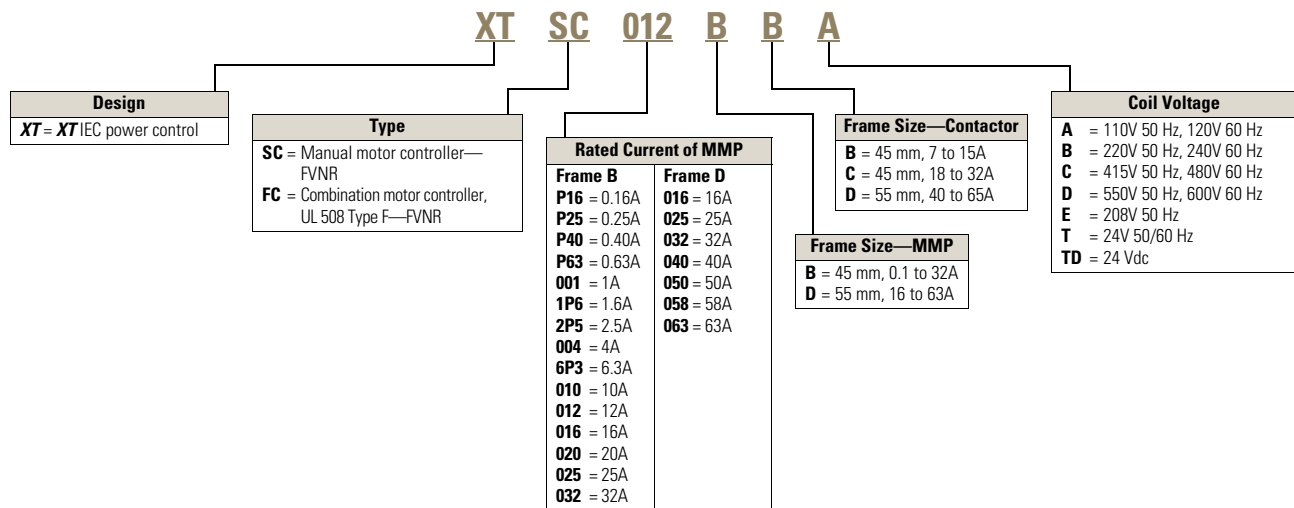

Product Selection

2 XTSC Manual Motor Controllers (MMC)/Starter Combinations

Factory Assembled Motor Protective Device with Thermal and Magnetic Trip + Contactor

FLA Adjustment Range (A) ①	Short Circuit Release— I_{rm} (A)	Maximum Motor Ratings—P ②								Assembled Manual Motor Controller ③ Non-Reversing— Catalog Number
		Maximum kW Rating AC-3—P (kW) Three-Phase			Maximum hp Rating—P (hp) Three-Phase					
		220–240V	380–415V	500V	660–690V	200V	240V	480V	600V	
Frame B MMP + Frame B Contactor										
0.1–0.16	3.2	—	—	—	0.06	④	④	1/2	1/2	XTSCP16BB_
0.16–0.25	3.5	—	0.06	0.06	0.12	④	④	1/2	1/2	XTSCP25BB_
0.25–0.4	5.6	0.06	0.09	0.12	0.18	④	④	1/2	1/2	XTSCP40BB_
0.4–0.63	8.82	0.09	0.18	0.25	0.25	④	④	1/2	1/2	XTSCP63BB_
0.63–1	14	0.12	0.25	0.37	0.55	④	④	1/2	1/2	XTSC001BB_
1–1.6	22.4	0.25	0.55	0.75	1.1	④	④	3/4	1	XTSC1P6BB_
1.6–2.5	35	0.37	0.75	1.1	1.5	1/2	1/2	1	1-1/2	XTSC2P5BB_
2.5–4	56	0.75	1.5	2.2	3	1	1	2	3	XTSC004BB_
4–6.3	88.2	1.1	2.2	3	4	1-1/2	1-1/2	3	5	XTSC6P3BB_
6.3–10	140	2.2	4	4	7.5	3	3	7-1/2	10	XTSC010BB_
8–12	168	3	5.5	5.5	11	3	3	7-1/2	10	XTSC012BB_
10–16	224	4	7.5	9	12.5	3	3	10	10	XTSC016BB_
Frame B MMP + Frame C Contactor										
10–16	224	4	7.5	9	12.5	3	3	10	10	XTSC016BC_
16–20	280	5.5	9	12.5	15	5	5	10	15	XTSC020BC_
20–25	350	5.5	11	15	22	5	7-1/2	15	20	XTSC025BC_
25–32	448	7.5	15	22	30	7-1/2	10	20	25	XTSC032BC_
Frame D MMP + Frame C Contactor										
10–16	224	4	7.5	9	12.5	3	5	10	15	XTSC016DC_
16–25	350	5.5	12.5	12.5	22	7-1/2	7-1/2	20	25	XTSC025DC_
25–32	448	7.5	15	17.5	22	10	10	25	30	XTSC032DC_
Frame D MMP + Frame D Contactor										
32–40	560	11	20	22	30	10	—	30	30	XTSC040DD_
40–50	700	14	25	30	45	15	15	30	40	XTSC050DD_
50–58	812	17	30	37	55	—	—	40	—	XTSC058DD_
55–65	882	18.5	34	37	55	—	—	40	—	XTSC063DD_

Notes

The assembled Manual Motor Controller (MMC) consists of an XTPR Manual Motor Protector (MMP) and an XTCE contactor. For Frame B MMP + Frame B Contactor assemblies, the XTSC can be mounted directly on DIN rail without an adapter. The contactors are supported mechanically with a mechanical connection element (included in XTPAXTPCB). For 16A and above, the assembly is mounted via a DIN rail adapter plate (XTPAXTPCPC, XTPAXTPCPD) and the electrical connection is made with electrical contact modules (XTPAXECMC, XTPAXECMD), both included in XTPAXTPCC and XTPAXTPCD.

Service Factor (SF)—Setting I_r of current scale in dependence of load factor:

SF = 1.15 → $I_r = 1 \times I_n$ mot

SF = 1 → $I_r = 0.9 \times I_n$ mot

① Overload release— I_r .

② Select manual motor protectors by full load amperes. Maximum motor ratings (kW, hp) are for reference only.

③ Underscore (_) indicates magnet coil suffix required. See **Page V9-T2-43**.

④ In this range, calculate motor rating according to rated current. Specified values to NEC 430.6(A)(1).

XTFC Combination Motor Controllers (CMC), UL 508 Type F

Factory Assembled Motor Protective Device with Thermal and Magnetic Trip + Contactor + Required Line Side Adapter

FLA Adjustment Range (A) ①	Short Circuit Release— I_{rm} (A)	Maximum Motor Ratings—P ②								Assembled Manual Motor Controller ③ Non-Reversing— Catalog Number
		Maximum kW Rating AC-3—P (kW) Three-Phase			Maximum hp Rating—P (hp) Three-Phase					
		220–240V	380–415V	500V	660–690V	200V	240V	480V	600V	
Frame B MMP + Frame B Contactor										
0.1–0.16	2.2	—	—	—	0.06	④	④	1/2	1/2	XTFCP16BB_
0.16–0.25	3.5	—	0.06	0.06	0.12	④	④	1/2	1/2	XTFCP25BB_
0.25–0.4	5.6	0.06	0.09	0.12	0.18	④	④	1/2	1/2	XTFCP40BB_
0.4–0.63	8.82	0.09	0.18	0.25	0.25	④	④	1/2	1/2	XTFCP63BB_
0.63–1	14	0.12	0.25	0.37	0.55	④	④	1/2	1/2	XTFC001BB_
1–1.6	22.4	0.25	0.55	0.75	1.1	④	④	3/4	1	XTFC1P6BB_
1.6–2.5	35	0.37	0.75	1.1	1.5	1/2	1/2	1	1-1/2	XTFC2P5BB_
2.5–4	56	0.75	1.5	2.2	3	1	1	2	3	XTFC004BB_
4–6.3	88.2	1.1	2.2	3	4	1-1/2	1-1/2	3	5	XTFC6P3BB_
6.3–10	140	2.2	4	4	7.5	3	3	7-1/2	10	XTFC010BB_
8–12	168	3	5.5	5.5	11	3	3	7-1/2	—	XTFC012BB_
10–16	224	4	7.5	9	12.5	3	5	10	—	XTFC016BB_
Frame B MMP + Frame C Contactor										
10–16	224	4	7.5	9	12.5	3	5	10	—	XTFC016BC_
16–20	280	5.5	9	12.5	15	5	5	—	—	XTFC020BC_
20–25	350	5.5	11	15	22	5	7-1/2	15	—	XTFC025BC_
25–32	448	7.5	15	22	30	7-1/2	10	20	—	XTFC032BC_
Frame D MMP + Frame C Contactor										
10–16	224	4	7.5	9	12.5	3	5	10	10	XTFC016DC_
16–25	350	5.5	12.5	12.5	22	7-1/2	7-1/2	20	25	XTFC025DC_
25–32	448	7.5	15	17.5	22	10	10	25	30	XTFC032DC_
Frame D MMP + Frame D Contactor										
32–40	560	11	20	22	30	10	10	30	40	XTFC040DD_
40–50	700	14	25	30	45	10	15	30	—	XTFC050DD_
50–58	812	17	30	37	55	15	15	40	—	XTFC058DD_
55–65	882	18.5	34	37	55	15	15	40	—	XTFC063DD_

Magnet Coil Suffix

Coil Voltage	Suffix Code
110V 50 Hz, 120V 60 Hz	A
220V 50 Hz, 240V 60 Hz	B
24V 50/60 Hz	T
24 Vdc	TD ⑤
415V 50 Hz, 480V 60 Hz	C
550V 50 Hz, 600V 60 Hz	D
208V 60 Hz	E

Notes

The assembled Combination Motor Controller (CMC) consists of an XTPR Manual Motor Protector (MMP) and an XTCE contactor and a required Line Side Adapter. For Frame B MMP + Frame B Contactor assemblies, the XTFC and XTFR can be mounted directly on DIN rail without an adapter. The contactors are supported mechanically with a mechanical connection element (included in XTPAXTPCB, XTPAXRPCR).

For 16A and above, the assembly is mounted via a DIN rail adapter plate (XTPAXTPCPC, XTPAXTPCPD) and the electrical connection is made with electrical contact modules (XTPAXECMC, XTPAXECMD), both included in XTPAXTPCC and XTPAXTPCD.
 $SF = 1.15 \rightarrow I_r = 1 \times I_n \text{ mot}$
 $SF = 1 \rightarrow I_r = 0.9 \times I_n \text{ mot}$

- ① Overload release— I_r .
- ② Select combination motor controllers by full load amperes. Maximum motor ratings (kW, hp) are for reference only.
- ③ Underscore (_) indicates magnet coil suffix required. See table at left.
- ④ In this range, calculate motor rating according to rated current. Specified values to NEC 430.6(A)(1).
- ⑤ With DC operation: Integrated diode-resistor combination, coil rating 2.6W.

Accessories

2

Auxiliary Contacts

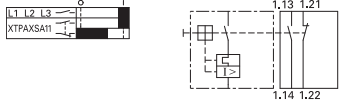
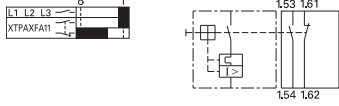
Contact Configuration	Contact Sequence	Screw Terminals Pkg. Qty.	Catalog Number
Side-Mount			
1NO-1NC		5	XTPAXSA11
Front-Mount			
1NO-1NC		5	XTPAXFA11

Rotary Handle Mechanism



IP65 Rotary Handle Mechanism ①②③

Description	Pkg. Qty.	Catalog Number
Complete Kits—Includes Handle, Shaft and Required Hardware		
Rotary handle mechanism IP65 black—for use on main switches to IEC/EN 60204.	1	XTPAXRHMB
Rotary handle mechanism IP65 red/yellow—for use on main switch with emergency-stop function to IEC/EN 60204.	1	XTPAXRHMR
Rotary handle mechanism IP65 black—for use on main switches to IEC/EN 60204 where XTPR is mounted 90° from vertical.	1	XTPAXRHM90B
Rotary handle mechanism IP65 red/yellow—for use on main switch with emergency-stop function to IEC/EN 60204 where XTPR is mounted 90° from vertical.	1	XTPAXRHM90RY

Shunt Release



Shunt Release

Pkg. Qty.	Screw Terminals— Catalog Number
2	XTPAXSR120V60H
2	XTPAXSR240V60H
2	XTPAXSR480V60H
2	XTPAXSR24VDC

Undervoltage Release



Undervoltage Release

Pkg. Qty.	Screw Terminals— Catalog Number
2	XTPAXUVR120V60H
2	XTPAXUVR240V60H
2	XTPAXUVR480V60H

Notes

- ① With ON/OFF switch position and “+” (tripped), lockable with three padlocks, 4–8 mm hasp. Can be locked in the OFF position, if required.
- ② Rotary handle mechanisms ship with door interlock disabled. See instruction publication with product for how to enable door interlock.
- ③ Not for use with XTPAXFAEM20 early-make front-mount auxiliary contact.

Three-Phase Commoning Links ^①

MMP—Frame B

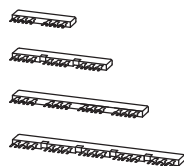

For Use With...	Qty MMP	Length of Link (mm)	Unit Width (mm)	Pkg. Qty.	Catalog Number
Frame B					
MMP with no side-mounted auxiliaries or voltage releases	2	90	45	10	XTPAXCLKA2
	3	135	45	10	XTPAXCLKA3
	4	180	45	10	XTPAXCLKA4
	5	225	45	10	XTPAXCLKA5

MMP—Frame D

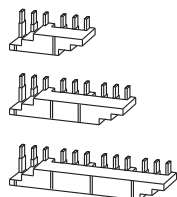

For Use With...	Qty MMP	Length of Link (mm)	Unit Width (mm)	Pkg. Qty.	Catalog Number
Frame D					
MMP with no side-mounted auxiliaries or voltage releases	2	110	55	1	XTPAXCLKA2D
	3	165	55	1	XTPAXCLKA3D
	4	220	55	1	XTPAXCLKA4D

Incoming Terminal



Incoming Terminal for Three-Phase Commoning Link ^②

For Use With...	Pkg. Qty.	Catalog Number
B Frame XTPR, XTPB	5	XTPAXIT

Line-Side Adapter



Line-Side Adapter ^③

For Use With...	Pkg. Qty.	Catalog Number
B Frame XTPR to create a UL 508 type E/F manual combination starter	5	XTPAXLSA
D Frame XTPR to create a UL 508 type E/F manual combination starter	1	XTPAXLSAD ^④

Notes

- ① Protected against accidental contact. B Frame short circuit proof Ue = 690V, Iu = 63A; D Frame short circuit proof Ue = 690V, Iu = 128A. Frame B links can be combined by rotating mounting. Frame D links cannot be combined.
- ② For three-phase commoning link, protected against accidental contact, Ue = 690V, Iu = 63A; for conductor cross-sections: 2.5–25 mm² stranded; 2.5–16 mm² flexible with ferrules, AWG 14-6.
- ③ XTPAXLSA is for three-phase commoning link, finger- and back-of-hand proof, Ue = 690V, Iu = 60A; for conductor cross sections: 2.5–25 mm² stranded, 2.5–16 mm² flexible with ferrule, AWG 14-6.
- ④ XTPAXLSAD cannot be combined with three-phase commoning links.

Non-Reversing Starters

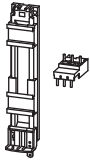
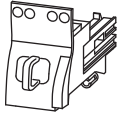

Combination Connection Kits for Connection of XTPR MMP with XTCE Contactor

For Use With...	Description	Std. Pack	Catalog Number
Non-Reversing Starters			
XTPR...B + XTCE...B	Comprised of: Mechanical connection element for XTPR...B and contactor Main current wiring between XTPR...B and contactor in tool-less plug connection Cable guidance Use contactor auxiliary switch XTCEXFAT_ Control cable guidance: max. six cables up to 2.5 mm ² external diameter or four cables up to 3.5 mm ² external diameter.	1	XTPAXTPCB
XTPR...B + XTCE...C XTPR...D + XTCE...D	Comprised of: DIN rail adapter plate Main current wiring between XTPR and contactor	1	XTPAXTPCC XTPAXTPCD

Insulated Enclosures

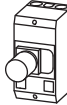
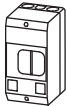

Insulated Enclosures for Surface Mounting

Degree of Protection	For Use With...	Description	Catalog Number
XTPB Pushbutton Manual Motor Protectors—North American Usage ^{①②}			
IP65 NEMA 3R, 4X, 12, 13	XTPB MMP only or with: XTPAXFA_, XTPBXFAEM20, XTPAXSA_, XTPAXUVR_, XTPAXSR_, XTPAXCL	With actuating diaphragm	XTPBXENAS65
IP65 NEMA 3R, 4X, 12, 13	XTPB MMP only or with: XTPAXFA_, XTPBXFAEM20, XTPAXUVR_, XTPAXSR_, XTPAXCL	With emergency-stop (E-stop) pushbutton actuator, red/yellow	XTPBXENASES65
B Frame (0.1–32A) XTPR Rotary Manual Motor Protectors—North American Usage ^③			
IP55 NEMA 1, 12, 3R	B Frame XTPR Only or with: XTPAXSA_ and XTPAXFA_, XTPAXUVR_ and XTPAXFA_, XTPAXSR_ and XTPAXFA_, XTPAXCL	With red/yellow rotary handle for use as emergency-stop switch to VDE 0113	XTPAXENAS55RY
D Frame (10–65A) XTPR Rotary Manual Motor Protectors ^{④⑤}			
IP65 NEMA 1, 12, 3R, 4X	D Frame XTPR only or with: XTPAXFA_, XTPAXFAEM20, XTPAXSA_, XTPAXSATR_, XTPAXUVR_, XTPAXSR_, XTPAXCL	With red/yellow rotary handle for use as emergency-stop switches to IEC/EN 60204	XTPAXENCSD65RY

Notes

- ① Built-in terminal for PE(N).
- ② North American enclosures come with conduit adapters for use with 1/2 NPT.
- ③ Built-in N and PE terminal, lower part without knockouts.
- ④ Integrated terminal for PE(N) connection.
- ⑤ % Metric knockouts:
Top ÷ bottom: M25/M32
In backplate: M25/M32
Control cable entry: M20

Product Overview

Soft Starters Selection Guide



Description	DS7	DS6	S611	S801+	S811+
	Page V9-T2-48	Page V9-T2-50	Page V9-T2-51	Page V9-T2-55	Page V9-T2-58
Power					
Current range (A)	4–32	41–200	26–414	11–1000	11–1000
Phases	Two-phase control	Two-phase control	Three-phase	Three-phase	Three-phase
Input voltage (line voltage)	0–460V	0–460V	0–600V	0–600V; 690V on V and T Frame	0–600V; 690V on V and T Frame
Horsepower range	460V: 2–20 hp	460V: 30–150 hp	460V: 40–350 hp	460V: 25–800 hp	460V: 25–800 hp
Internal run-bypass	Yes	Yes	Yes	Yes	Yes
Inside-the-delta control	—	—	—	Yes	Yes
Control					
User interface	Dials	Dials	LED and keypad	Dials and DIP switches	LCD and keypad
Control voltage	24 Vac/Vdc or 120–240 Vac	24 Vdc	120 Vac	24 Vdc	24 Vdc
Communications	—	—	Modbus RTU, EtherNet/IP, Modbus TCP, PROFIBUS, DeviceNet	—	Modbus RTU, EtherNet/IP, Modbus TCP
Program relays	—	—	Yes	Yes	Yes
Soft Start					
Voltage ramp initial current	5–85% LRT	5–85% LRT	5–85% LRT	5–85% LRT	5–85% LRT
Voltage ramp time	1–30 sec	1–30 sec	0.5–180 sec	0.5–180 sec	0.5–180 sec
Current limit	—	—	5–85% LRT	5–85% LRT	5–85% LRT
Current limit time	—	—	0.5–180 sec	0.5–180 sec	0.5–180 sec
Kick start current	—	—	5–85% LRT	5–85% LRT	5–85% LRT
Kick start time	—	—	0–2 sec	0–2 sec	0–2 sec
Jog	—	—	—	Yes	Yes
Soft Stop					
Stop ramp time	0–30 sec	0–30 sec	0–60 sec	0–60 sec	0–60 sec
Pump control	—	—	Optional	Optional	Optional
Environmental					
Operating temperature	0° to 40°C	0° to 40°C	–20° to 50°C	–30° to 50°C	–30° to 50°C
Humidity	0–95% noncondensing	0–95% noncondensing	0–95% noncondensing	0–95% noncondensing	0–95% noncondensing
Altitude	<2000M	<2000M	<2000M	<2000M	<2000M

DS7 Soft Start Controller



Features

- Small size
- Patented asymmetric delay angle control—makes torque behavior similar to a three-phase control device
- Integrated bypass
- It can take 24 Vac/Vdc or 110V/230 Vac control voltage
- Mechanical and electrical toolless assembly with MMPs
- Low cost solution compared to three-phase control devices
- Full UL approval

Product Selection

DS7 Soft Start Controller

Please refer to Application Note AP03901006E for additional information on proper size selection.

DS7 Soft Start Controller—Frame 1



DS7 Soft Start Controllers—Horsepower Ratings— 10 Second Ramp, One Start per Hour, 300% Current Limit at 40°C ①

Rated Current (A)	Motor Power (hp)			Maximum Allowable Breaker Size	Maximum Allowable Fuse Size	Recommended XTOB Overload (Direct Connect) ②	Recommended XTOE Overload ②	MMP ②	Connection Kit to MMP	Catalog Number
	200V	230V	480V							
3.7	0.75	0.75	2	HFD3015	15A Class RK5	XTOB004BC1	XTOE005BCS	XTPR004BC1	XTPAXTPCB	DS7-340SX004NO-N ③ DS7-342SX004NO-N ④
6.9	1.5	2	3	HFD3015	15A Class RK5	XTOB006BC1 ①	XTOE020BCS	XTPR6P3BC1	XTPAXTPCB	DS7-340SX007NO-N ③ DS7-342SX007NO-N ④
7.8	2	2	5	HFD3020	20A Class RK5	XTOB010BC1	XTOE020BCS	XTPR010BC1	XTPAXTPCB	DS7-340SX009NO-N ③ DS7-342SX009NO-N ④
11	3	3	7.5	HFD3030	20A Class RK5	XTOB012BC1	XTOE020BCS	XTPR012BC1	XTPAXTPCB	DS7-340SX012NO-N ③ DS7-342SX012NO-N ④
15.2	3	5	10	HFD3035	25A Class RK5	XTOB016CC1	XTOE020CCS	XTPR016BC1	XTPAXTPCC	DS7-340SX016NO-N ③ DS7-342SX016NO-N ④
22	5	7.5	15	HFD3060	40A Class RK5	XTOB024CC1	XTOE045CCS	XTPR025BC1	XTPAXTPCC	DS7-340SX024NO-N ③ DS7-342SX024NO-N ④
32	7.5	10	20	HFD3070	50A Class RK5	XTOB032CC1	XTOE045CCS	XTPR032BC1	XTPAXTPCC	DS7-340SX032NO-N ③ DS7-342SX032NO-N ④

Notes

- ① Actual motor FLAs vary. Verify these devices cover the motor specific FLA.
- ② Selections are based on motor FLA value at 480V.
- ③ 24 Vac/Vdc device.
- ④ 120/230 Vac device.

Please refer to Application Note AP03901006E for additional information on proper size selection.

DS7 Soft Start Controller—Frame 1



**DS7 Soft Start Controllers—Horsepower Ratings—
10 Second Ramp, One Start per Hour, 400% Current Limit at 40°C ①**

Rated Current (A)	Motor Power (hp)			Maximum Allowable Breaker Size	Maximum Allowable Fuse Size	Recommended XTOB Overload (Direct Connect) ②	Recommended XTOE Overload ②	MMP ②	Connection Kit to MMP	Catalog Number
	200V	230V	480V							
3	0.5	0.5	1.5	HFD3015	15A Class RK5	XTOB004BC1	XTOE005BCS	XTPR004BC1	XTPAXTPCB	DS7-340SX004NO-N ③ DS7-342SX004NO-N ④
4.8	1	1	3	HFD3015	15A Class RK5	XTOB006BC1 ①	XTOE020BCS	XTPR6P3BC1	XTPAXTPCB	DS7-340SX007NO-N ③ DS7-342SX007NO-N ④
6.9	1.5	2	3	HFD3020	20A Class RK5	XTOB006BC1	XTOE020BCS	XTPR6P3BC1	XTPAXTPCB	DS7-340SX009NO-N ③ DS7-342SX009NO-N ④
9	2	2	5	HFD3030	20A Class RK5	XTOB010BC1	XTOE020BCS	XTPR010BC1	XTPAXTPCB	DS7-340SX012NO-N ③ DS7-342SX012NO-N ④
11	3	3	7.5	HFD3035	25A Class RK5	XTOB016CC1	XTOE020CCS	XTPR016BC1	XTPAXTPCC	DS7-340SX016NO-N ③ DS7-342SX016NO-N ④
17.5	5	5	10	HFD3060	40A Class RK5	XTOB016CC1	XTOE045CCS	XTPR016BC1	XTPAXTPCC	DS7-340SX024NO-N ③ DS7-342SX024NO-N ④
22	5	7.5	15	HFD3070	50A Class RK5	XTOB024CC1	XTOE045CCS	XTPR025BC1	XTPAXTPCC	DS7-340SX032NO-N ③ DS7-342SX032NO-N ④

Notes

- ① Actual motor FLAs vary. Verify these devices cover the motor specific FLA.
- ② Selections are based on motor FLA value at 480V.
- ③ 24 Vac/Vdc device.
- ④ 120/230 Vac device.

DS6 Soft Start Controller



Features

- Run bypass mode greatly reduces internal heating created by the power dissipation across the SCRs. The bypass contactor directly connects the motor to the line and improves system efficiency by reducing internal power losses
- Less heat minimizes enclosure size and cooling requirements, and maximizes the life of all devices in the enclosure
- LED displays device status and provides fault indication
- Variable ramp times and voltage control (torque control) settings provide unlimited starting configurations, allowing for maximum application flexibility
- Minimizes the peak inrush current's stress on the power system
- Minimizes peak starting torque to diminish mechanical system wear and damage

Product Selection

DS6 Soft Start Controller

For 400% ramp, see Volume 6—Solid-State Motor Control, CA08100007E, Tab 1.

DS6 Soft Start Controller—Horsepower Rating, 10-Second Ramp, One Start per Hour, 300% Current Limit at 40°C

Rated Current (A)	Motor Power (hp)			Maximum Allowable Breaker Size a	Maximum Allowable Fuse Size ①	Recommended XT0B Overload	Recommended C396 Overload	Catalog Number
	200V	230V	460V					
40	10	10	30	HFD3150L	150A Class RK5	XT0B040DC1 ②	C396A2A045SELAX	DS6-34DSX041N0-N
52	15	20	40	HFD3200L	200A Class RK5	XT0B057DC1 ②	C396B2A075SELAX	DS6-34DSX055N0-N
65	20	25	50	HJD3250	200A Class RK5	XT0B065DC1 ②	C396B2A075SELAX	DS6-34DSX068N0-N
77	25	30	60	HKD3300	300A Class RK5	XT0B100GC1S	C396B2A110SELAX	DS6-34DSX081N0-N
96	30	30	75	HKD3350	350A Class RK5	XT0B100GC1S	C396B2A110SELAX	DS6-34DSX099N0-N
124	40	50	100	HKD3400	500A Class RK5	XT0B125GC1S	C396C2A150SELAX	DS6-34DSX134N0-N
156	50	60	125	HLD3450	500A Class RK5	XT0B160LC1 ③	C396A2A005SELAX ④	DS6-34DSX161N0-N
180	60	75	150	HLD3500	500A Class RK5	XT0B220LC1 ③	C396A2A005SELAX ④	DS6-34DSX196N0-N

Power Supply Selection

Description	Catalog Number
85–264V input and 24V output	ELC-PS01
380–480V input and 24V output	PSS25F
100–240 Vac input and 24 Vdc output	PSG60E
380–480 Vac input and 24 Vdc output	PSG60F

Notes

- ① Maximum values may be higher than allowed per NEC 430.52 and UL 508A 31.1.
- ② XT0BXDIND panel mounting adaptor must be used with this overload.
- ③ XT0BXTLL line and load lugs must be used with this overload.
- ④ C396CTK300 current transformer must be used with this overload.

S611 Soft Starter



Features

- Integrated bypass
- Integrated electronic overload protection
- 120V control
- Power monitoring
- Intuitive user interface
- Field serviceability (control board, contactors)
- Pump control option
- Modbus RTU native
- Plug-and-play EtherNet IP / Modbus TCP / PROFIBUS / DeviceNet adapters
- Control board mounted underneath the cover
- High fault combination rating up to 100 kA
- Available in NEMA 1/12/3R/4/4X enclosures

Catalog Number Selection

S611 Soft Starter

Solid-State Soft Starter

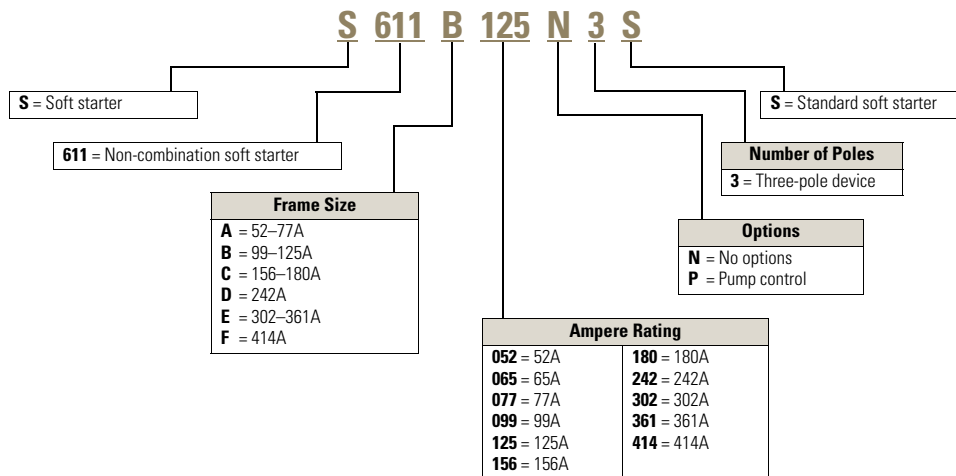

Product Selection

2

Horsepower Ratings

Note: Always refer to motor plate FLA and ensure that the motor plate FLA is equal to or lower than the maximum current value in the tables.

S611



Standard Duty—300% Current for 15 Seconds, 115% Continuous

Maximum Current (Amps)	Horsepower Rating				Catalog Number
	208V	240V	480V	600V	
52	15	15	40	50	S611A052N3S
65	20	20	50	60	S611A065N3S
77	25	25	60	75	S611A077N3S
99	30	30	75	100	S611B099N3S
125	40	40	100	125	S611B125N3S
156	50	60	125	150	S611C156N3S
180	60	60	150	150	S611C180N3S
242	75	75	200	250	S611D242N3S
302	100	100	250	300	S611E302N3S
361	125	150	300	350	S611E361N3S
414	150	150	350	450	S611F414N3S

Standard Duty Plus—350% FLA for 30 Seconds, 115% Continuous

Maximum Current (Amps)	Horsepower Rating				Catalog Number
	208V	240V	480V	600V	
52	15	15	40	50	S611A052N3S
65	20	20	50	60	S611A065N3S
71	20	25	60	75	S611A077N3S
99	30	30	75	100	S611B099N3S
119	40	40	100	125	S611B125N3S
156	50	60	125	150	S611C156N3S
180	60	60	150	150	S611C180N3S
242	75	75	200	250	S611D242N3S
302	100	100	250	300	S611E302N3S
361	125	150	300	350	S611E361N3S
407	150	150	350	400	S611F414N3S

Note: Always refer to motor plate FLA and ensure that the motor plate FLA is equal to or lower than the maximum current value in the tables.

S611



Heavy Duty—500% FLA for 30 Seconds, 125% Continuous

Maximum Current (Amps)	Horsepower Rating		480V	600V	Catalog Number
	208V	240V			
49	15	15	40	50	S611A052N3S
83	25	30	60	75	S611B099N3S
142	40	60	125	150	S611C156N3S
225	75	75	200	200	S611D242N3S
256	75	100	200	250	S611E361N3S
285	100	125	250	300	S611F414N3S

Severe Duty—600% FLA for 30 Seconds, 125% Continuous

Maximum Current (Amps)	Horsepower Rating		480V	600V	Catalog Number
	208V	240V			
41	10	15	30	40	S611A052N3S
69	20	30	60	60	S611B099N3S
117	30	50	100	125	S611C180N3S
187	60	75	150	200	S611D242N3S
213	75	75	150	200	S611E361N3S
238	75	100	200	250	S611F414N3S

Accessories

Optional Accessory Kits

Description	S611 Current Rating	Accessory Kit Part Number
User interface remote mounting kit—3.28 ft (1m)	52–414A	S611-RMK-100
User interface remote mounting kit—6.56 ft (2m)	52–414A	S611-RMK-200
User interface remote mounting kit—9.84 ft (3m)	52–414A	S611-RMK-300
User interface communication cable—3.28 ft (1m)	52–414A	D77E-QPIP100
User interface communication cable—6.56 ft (2m)	52–414A	D77E-QPIP200
User interface communication cable—9.84 ft (3m)	52–414A	D77E-QPIP300
Lug kit—mechanical	52–77A	S611-LUG-M01
	99–125A	S611-LUG-M02
	156–242A	S611-LUG-M03
	302–414A	S611-LUG-M04

Options

2

Pump Control

For pump control option, change the **8th** digit in the Catalog Number to **P**, as in S611XXX**P**3S.

Replacement Parts

S611 Replacement Components

Description	Part Number
User interface	S611-KEYPAD
User interface communication cable—0.25m (0.82 ft)	D77E-QPIP25
Control board assembly—52A standard	S611-PCB-052S
Control board assembly—65A standard	S611-PCB-065S
Control board assembly—77A standard	S611-PCB-077S
Control board assembly—99A standard	S611-PCB-099S
Control board assembly—125A standard	S611-PCB-125S
Control board assembly—156A standard	S611-PCB-156S
Control board assembly—180A standard	S611-PCB-180S
Control board assembly—242A standard	S611-PCB-242S
Control board assembly—302A standard	S611-PCB-302S
Control board assembly—361A standard	S611-PCB-361S
Control board assembly—414A standard	S611-PCB-414S
Control board assembly—52A pump	S611-PCB-052P
Control board assembly—65A pump	S611-PCB-065P
Control board assembly—77A pump	S611-PCB-077P
Control board assembly—99A pump	S611-PCB-099P
Control board assembly—125A pump	S611-PCB-125P
Control board assembly—156A pump	S611-PCB-156P
Control board assembly—180A pump	S611-PCB-180P
Control board assembly—242A pump	S611-PCB-242P
Control board assembly—302A pump	S611-PCB-302P
Control board assembly—361A pump	S611-PCB-361P
Control board assembly—414A pump	S611-PCB-414P
Frame A/B CT	S611-CT-AB
Frame C/D CT	S611-CT-CD
Frame E/F CT	S611-CT-EF
Contactor assembly—52–180A	C25DNY172
Contactor assembly—242–414A	C25DNY173

S801+ Soft Starters



Features

- Smaller size
- Physically fits in place of most NEMA and IEC starters
- Built-in run bypass contactor
- Built-in overload protection
- Adjustable ramp times
- Adjustable kick start control
- Dial and DIP switch user interface (CIM)
- Alarm and warning capability
- Analog input

Catalog Number Selection

S801+ Soft Starter

S801+ Open Soft Starters ①②

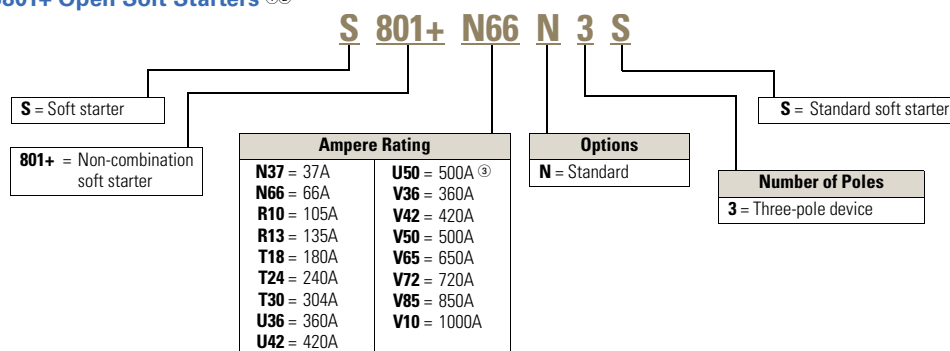

Notes

- ① S801+T_, S801+U_ and S801+V_ units require lug kits found on **Pages V9-T2-63**.
- ② All units require a 24 Vdc power supply found on catalog **Pages V9-T2-63**, or equivalent.
- ③ S801+U50N3S unit does not have IEC certification.

Product Selection

2

Standard Duty

S801+



Standard Duty— 15 Second Ramp, 300% Current Limit at 40°C, Inline Connection

Max. Current	Three-Phase Motors kW Rating (50 Hz)			hp Rating (60 Hz)				575–600V				Catalog Number
	230V	380–400V	440V	200V 1.0SF	1.15SF	230V 1.0SF	1.15SF	460V 1.0SF	1.15SF	1.0SF	1.15SF	
Frame Size N												
37	10	18.5	18.5	10	10	10	10	25	20	30	30	S801+N37N3S
66	18.5	30	37	20	15	20	20	50	40	60	50	S801+N66N3S
Frame Size R												
105	30	55	59	30	25	40	30	75	60	100	75	S801+R10N3S
135	40	63	80	40	30	50	40	100	75	125	100	S801+R13N3S
Frame Size T												
180	51	90	110	60	50	60	60	150	125	150	150	S801+T18N3S
240	75	110	147	75	60	75	75	200	150	200	200	S801+T24N3S
304	90	160	185	100	75	100	100	250	200	300	250	S801+T30N3S
Frame Size U												
360	110	185	220	125	100	150	125	300	250	350	300	S801+U36N3S
420	129	220	257	150	125	175	150	350	300	450	350	S801+U42N3S
500	150	257	300	150	150	200	150	400	350	500	450	S801+U50N3S ①
Frame Size V												
360	110	185	220	125	100	150	125	300	250	350	300	S801+V36N3S
420	129	220	257	150	125	175	150	350	300	450	350	S801+V42N3S
500	150	257	300	150	150	200	150	400	350	500	450	S801+V50N3S
650	200	355	425	250	200	250	200	500	450	600	500	S801+V65N3S
720	220	400	450	—	—	300	250	600	500	700	600	S801+V72N3S
850	257	475	500	—	—	350	300	700	600	900	700	S801+V85N3S
1000	277	525	550	—	—	400	350	800	700	900	800	S801+V10N3S

Note

① S801+U50N3S does not have IEC certification.

Severe Duty

S801+



Severe Duty—>30 Second Ramp, >300% Current Limit

Max. Current	Three-Phase Motor kW Rating (50 Hz)			hp Rating (60 Hz)								Catalog Number
	230V	380–400V	440V	200V 1.0SF	200V 1.15SF	230V 1.0SF	230V 1.15SF	460V 1.0SF	460V 1.15SF	575V 1.0SF	575V 1.15SF	
Frame Size N												
22	5.5	10	11	5	5	7-1/2	5	15	10	20	15	S801+N37N3S
42	11	18.5	22	10	10	15	10	30	25	40	30	S801+N66N3S
Frame Size R												
65	15	30	33	15	15	20	15	50	40	50	50	S801+R10N3S
80	22	40	45	25	20	30	25	60	50	75	60	S801+R13N3S
Frame Size T												
115	33	59	63	30	30	40	30	75	75	100	100	S801+T18N3S
150	45	80	90	50	40	50	50	100	100	150	125	S801+T24N3S
192	55	100	110	60	50	75	60	150	125	200	150	S801+T30N3S
Frame Size U												
240	75	110	147	75	60	75	75	200	150	200	200	S801+U36N3S
305	90	160	185	100	75	100	100	250	200	300	250	S801+U42N3S
365	110	185	220	125	100	150	125	300	250	350	300	S801+U50N3S ①
Frame Size V												
240	75	110	147	75	60	75	75	200	150	200	200	S801+V36N3S
305	90	160	185	100	75	100	100	250	200	300	250	S801+V42N3S
365	110	185	220	125	100	150	125	300	250	350	300	S801+V50N3S
420	129	220	257	150	125	150	150	350	300	450	350	S801+V65N3S
480	147	257	295	150	150	200	150	400	350	500	450	S801+V72N3S
525	160	280	335	150	150	200	150	450	350	500	450	S801+V85N3S
600	185	315	375	200	150	250	200	500	450	600	500	S801+V10N3S

Note

① S801+U50N3S unit does not have IEC certification.

2.4

Motor Control and Protection

Soft Starters

2

Type S811+ Soft Starters



Features

- Smaller size
- Physically fits in place of most NEMA and IEC starters
- Built-in run bypass contactor
- Built-in overload protection
- Adjustable ramp times
- Adjustable kick start control
- Native Modbus RTU and QCP communication
- kW and power factor measurement
- Cloning feature
- Alarm and warning capability
- Analog input
- Digital interface
- Pump control option
- Inside-the-delta capability

Catalog Number Selection

S811+ Soft Starter

S811+ Open Soft Starters ①

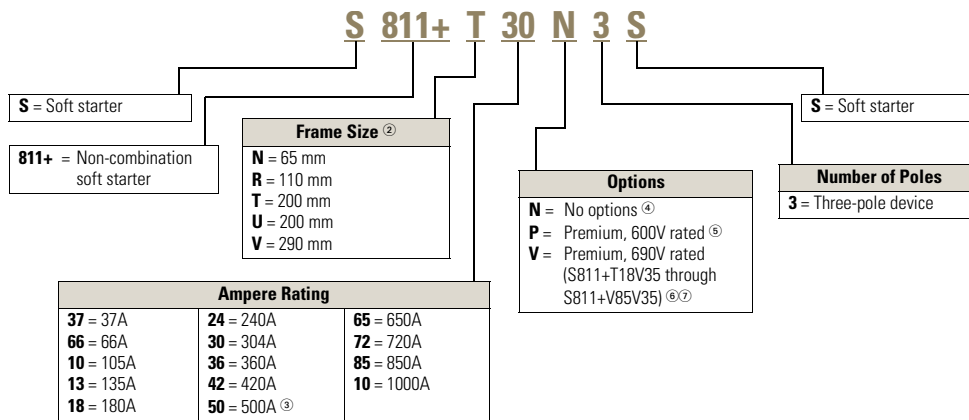

Notes

- ① All units require a 24 Vdc power supply found on catalog **Page V9-T2-63**, or equivalent.
- ② S811+T_, S811+U_ and S811+V_ units require lug kits found on **Page V9-T2-63**.
- ③ S811+U50_ unit does not have IEC certification.
- ④ Level/Edge Sense, Inline or Inside-the-Delta wiring configuration.
- ⑤ Level/Edge Sense, Inline or Inside-the-Delta wiring configuration, pump control and extended ramp.
- ⑥ Not available in S811+U_.
- ⑦ Level/Edge Sense, Inline wiring configuration, pump control, extended ramp.

Product Selection

Standard Duty

S811+



Standard Duty— 15 Second Ramp, 300% Current Limit at 40°C, Inline Connection

Max. Current	Three-Phase Motors kW Rating (50 Hz)			hp Rating (60 Hz)						575–690V ^①		Catalog Number
	230V	380–400V	440V	200V		230V		460V		1.0SF	1.15SF	
				1.0SF	1.15SF	1.0SF	1.15SF	1.0SF	1.15SF			
Frame Size N												
37	10	18.5	18.5	10	10	10	10	25	20	30	30	S811+N37N3S
66	18.5	30	37	20	15	20	20	50	40	60	50	S811+N66N3S
Frame Size R												
105	30	55	59	30	25	40	30	75	60	100	75	S811+R10N3S
135	40	63	80	40	30	50	40	100	75	125	100	S811+R13N3S
Frame Size T												
180	51	90	110	60	50	60	60	150	125	150	150	S811+T18N3S
240	75	110	147	75	60	75	75	200	150	200	200	S811+T24N3S
304	90	160	185	100	75	100	100	250	200	300	250	S811+T30N3S
Frame Size U												
360	110	185	220	125	100	150	125	300	250	350	300	S811+U36N3S
420	129	220	257	150	125	175	150	350	300	450	350	S811+U42N3S
500	150	257	300	150	150	200	150	400	350	500	450	S811+U50N3S ^②
Frame Size V												
360	110	185	220	125	100	150	125	300	250	350	300	S811+V36N3S
420	129	220	257	150	125	175	150	350	300	450	350	S811+V42N3S
500	150	257	300	150	150	200	150	400	350	500	450	S811+V50N3S
650	200	355	425	250	200	250	200	500	450	600	500	S811+V65N3S
720	220	400	450	—	—	300	250	600	500	700	600	S811+V72N3S
850	257	475	500	—	—	350	300	700	600	900	700	S811+V85N3S
1000	277	525	550	—	—	400	350	800	700	900	800	S811+V10N3S

Notes

① 690V is available only from S811+T18V3S through S811+V85V3S. Not available on S811+U...V3S.

② S811+U50_ rating does not have IEC certification.

Severe Duty

2

S811+



Severe Duty—30 Second Ramp and/or 450% Current Limit at 50°C, Inline Connection

Max. Current	Three-Phase Motors kW Rating (50 Hz)			hp Rating (60 Hz)				575–690V ^①				Catalog Number
	230V	380–400V	440V	200V 1.0SF	1.15SF	230V 1.0SF	1.15SF	460V 1.0SF	1.15SF	1.0SF	1.15SF	
Frame Size N												
22	5.5	10	11	5	5	7-1/2	5	15	10	20	15	S811+N37N3S
42	11	18.5	22	10	10	15	10	30	25	40	30	S811+N66N3S
Frame Size R												
65	15	30	33	15	15	20	15	50	40	50	50	S811+R10N3S
80	22	40	45	25	20	30	25	60	50	75	60	S811+R13N3S
Frame Size T												
115	33	59	63	30	30	40	30	75	75	100	100	S811+T18N3S
150	45	80	90	50	40	50	50	100	100	150	125	S811+T24N3S
192	55	100	110	60	50	75	60	150	125	200	150	S811+T30N3S
Frame Size U												
240	75	110	147	75	60	75	75	200	150	200	200	S811+U36N3S
305	90	160	185	100	75	100	100	250	200	300	250	S811+U42N3S
Frame Size V												
240	75	110	147	75	60	75	75	200	150	200	200	S811+V36N3S
305	90	160	185	100	75	100	100	250	200	300	250	S811+V42N3S
365	110	185	220	125	100	150	125	300	250	350	300	S811+V50N3S
420	129	220	257	150	125	150	150	350	300	450	350	S811+V65N3S
480	147	257	295	150	150	200	150	400	350	500	450	S811+V72N3S
525	160	280	335	150	150	200	150	450	350	500	450	S811+V85N3S
575	172	303	370	200	150	250	200	500	450	600	500	S811+V10N3S

Note

① 690V is available only from S811+T18V3S through S811+V85V3S. Not available on S811+U...V3S.

Inside-the-Delta, Standard Duty

S811+



Standard Duty—15 Second Ramp, 300% Current Limit at 40°C, Inside-the-Delta Connection

Max. Continuous Motor Line Current	Three-Phase Motor kW Rating (50 Hz)			hp Rating (60 Hz)								Catalog Number
	230V	380–400V	440V	200V		230V		460V		575V		
				1.0SF	1.15SF	1.0SF	1.15SF	1.0SF	1.15SF	1.0SF	1.15SF	
Frame Size N												
65	10	18.5	18.5	15	15	15	15	40	30	50	50	S811+N37N3S
114	18.5	30	37	30	25	30	30	75	60	100	75	S811+N66N3S
Frame Size R												
182	30	55	59	50	40	60	50	125	100	150	125	S811+R10N3S
234	40	63	80	60	50	75	60	150	125	200	150	S811+R13N3S
Frame Size T												
311	51	90	110	100	75	100	100	250	200	250	250	S811+T18N3S
415	75	110	147	125	100	125	125	300	250	300	300	S811+T24N3S
526	90	160	185	150	125	150	150	400	300	400	400	S811+T30N3S
Frame Size U												
623	110	185	220	200	150	250	200	450	400	550	450	S811+U36N3S
727	129	220	257	250	200	300	250	550	450	700	550	S811+U42N3S
865	150	257	300	250	250	300	250	600	550	750	700	S811+U50N3S ^{①②}
Frame Size V												
623	110	185	220	200	150	250	200	450	400	550	450	S811+V36N3S
727	129	220	257	250	200	300	250	550	450	700	550	S811+V42N3S
865	150	257	300	250	250	300	250	600	550	750	700	S811+V50N3S
1125	200	355	425	400	300	400	300	750	700	900	750	S811+V65N3S
1246	—	—	—	—	—	—	—	—	—	—	—	S811+V72N3S
1471	—	—	—	—	—	—	—	—	—	—	—	S811+V85N3S
—	—	—	—	—	—	—	—	—	—	—	—	S811+V10N3S

Notes

- ① 15 sec start, 300% inrush, 40°C, 1 start every 15 minutes. If these start parameters are exceeded, please refer to S811+V50_.
- ② S811+U50_ unit does not have IEC certification.

Inside-the-Delta, Severe Duty

2

S811+



Severe Duty—30 Second Ramp and/or 450% Current Limit at 50°C, Inside-the-Delta Connection

Max. Continuous Motor Line Current	Three-Phase Motor												Catalog Number
	kW Rating (50 Hz)			hp Rating (60 Hz)									
				200V		230V		460V		575V			
	230V	380–400V	440V	1.0SF	1.15SF	1.0SF	1.15SF	1.0SF	1.15SF	1.0SF	1.15SF		
Frame Size N													
39	5.5	10	11	7-1/2	7-1/2	10	7-1/2	25	15	30	25	S811+N37N3S	
73	11	18.5	22	15	15	25	15	50	40	60	50	S811+N66N3S	
Frame Size R													
111	15	30	33	25	25	30	25	75	60	75	75	S811+R10N3S	
138	22	40	45	40	30	50	40	100	75	120	100	S811+R13N3S	
Frame Size T													
199	33	59	63	50	50	60	50	125	125	150	150	S811+T18N3S	
257	45	80	90	75	60	75	75	150	150	250	200	S811+T24N3S	
324	55	100	110	100	75	100	100	250	200	300	250	S811+T30N3S	
Frame Size U													
415	75	110	147	125	100	125	125	300	250	300	300	S811+U36N3S	
526	90	160	185	150	120	150	150	400	300	450	400	S811+U42N3S	
623	110	185	220	200	150	250	200	450	400	550	450	S811+U50N3S ^①	
Frame Size V													
415	75	110	147	125	100	125	125	300	250	300	300	S811+V36N3S	
526	90	160	185	150	120	150	150	400	300	450	400	S811+V42N3S	
623	110	185	220	200	150	250	200	450	400	550	450	S811+V50N3S	
727	129	220	257	250	200	250	250	550	450	700	550	S811+V65N3S	
816	147	257	295	250	250	300	250	600	550	750	700	S811+V72N3S	
908	160	280	335	250	250	300	250	700	550	750	700	S811+V85N3S	
—	—	—	—	—	—	—	—	—	—	—	—	S811+V10N3S	

Note

① S811+U50_ unit does not have IEC certification.

Accessories

Lug Kits

S811+T_, S811U_ and S811+V_ soft starters each have different lug options based on your wiring needs. Each lug kit contains three lugs that can be mounted on either the load or line side.

Lug Kit



Lug Kits

S811+ Catalog Number	Description	Kits Required	Catalog Number
S811+T_, S811+U_	2 cable connections, 4 AWG to 1/0 cable	2	EML22
	1 cable connection, 4/0 to 500 kcmil cable		EML23
	2 cable connections, 4/0 to 500 kcmil cable		EML24
	1 cable connection, 2/0 to 300 kcmil cable		EML25
	2 cable connections, 2/0 to 300 kcmil cable		EML26
S811+V_	2 cable connections, 4/0 to 500 kcmil cable	2	EML28
	4 cable connections, 4/0 to 500 kcmil cable		EML30
	6 cable connections, 4/0 to 500 kcmil cable		EML32
	4 cable connections, 2/0 to 300 kcmil cable		EML33 ①

Power Supplies

24 Vdc power supply that can be used with the S811+ SSRV or as a stand-alone device.

Power Supplies

Description	Catalog Number
85–264 Vac input 24 Vdc output	PSG240E
360–575 Vac input 24 Vdc output	PSG240F

Lug Cover Kits

Replacement covers for the S811+T_, S811+U_ and S811+V_ soft starters are available in case of damage to the existing covers.

Lug Cover Kits

Description	Catalog Number
Lug cover S811+T_, S811+U_	EML27
Lug cover S811+V_	EML34

IP20 Kits

IP20 Kits

Description	Catalog Number
S811+N_	SS-IP20-N
S811+R_	SS-IP20-R
S811+T_ and S811+U_	SS-IP20-TU
S811+V_	SS-IP20-V

Surge Suppressors

The surge suppressor can mount on either the line or load side of the soft starter. It is designed to clip the line voltage (or load side induced voltage).

Surge Suppressor



Surge Suppressors

Description	Catalog Number
600V MOV for S811+_ units	EMS39
690V MOV for S811+_ units ②	EMS41

Notes

- ① The EML33 does not have a CSA listing.
- ② S811+T_ only.

2.4

Motor Control and Protection

Soft Starters

2

Mounting Plates

The mounting plates are designed to help make it easy to install or retrofit the soft starter into enclosures and MCCs. The soft starter can be mounted onto the plate prior to installation. The mounting plate is designed with tear drop mounting holes for easier installation.

Mounting Plates

Description	Catalog Number
S811+N_	EMM13N
S811+R_	EMM13R
S811+T_ and S811+U_	EMM13T
S811+V_	EMM13V

Vibration Plates

The vibration plates allow the soft starter to be applied in high shock and vibration applications. The vibration plate allows vibration up to 5g and shock in up to 40g. The soft starter is mounted onto the vibration plate prior to installation in the panel.

Vibration Plates

Description	Catalog Number
S811+N_	EMM14N
S811+R_	EMM14R
S811+T_ and S811+U_	EMM14T
S811+V_	EMM14V

Adapter Plates

The adapter plate allows customers to retrofit a S811+V_ soft starter with the S811+U_ soft starter.

Adapter Plates

Description	Catalog Number
Adapter plates	EMM13U

Control Wire Connector

Control Wire Connector

Description	Catalog Number
12-pin, 5 mm pitch connector for control wiring	EMA75

Digital Interface Module

The Digital Interface Module (DIM) is available as a replacement part.

DIM

Description	Catalog Number
Blank cover (filler)	EMA68
DIM for standard unit	EMA91
Panel mounting kit	
3 ft cable	EMA69A
5 ft cable	EMA69B
8 ft cable	EMA69C
10 ft cable	EMA69D

Options

S811+ Premium

In addition to what is already there in the S811+ standard, these devices offer pump control and extended ramp functions.

S811+ Premium

Current Range	Catalog Number
11–37	S811+N37P3S
20–66	S811+N66P3S
32–105	S811+R10P3S
42–135	S811+R13P3S
56–180	S811+T18P3S
75–240	S811+T24P3S
95–304	S811+T30P3S
112–360	S811+U36P3S
131–420	S811+U42P3S
156–500	S811+U50P3S ^①
112–360	S811+V36P3S
131–420	S811+V42P3S
156–500	S811+V50P3S
203–650	S811+V65P3S
225–720	S811+V72P3S
265–850	S811+V85P3S
312–1000	S811+V10P3S

Note

① S811+U50_ unit does not have IEC certification.

S811+ Premium 690V Option

In addition to what is already there in S811+ standard, this product offers 690V, pump control and extended ramp functions.

S811+ Premium 690V Option

Current Range	Catalog Number
56–180	S811+T18V3S
75–240	S811+T24V3S
95–304	S811+T30V3S
112–360	S811+V36V3S
131–420	S811+V42V3S
156–500	S811+V50V3S
203–650	S811+V65V3S
225–720	S811+V72V3S
265–850	S811+V85V3S

Cooling Fan Kit

The EMM18 cooling fan kit mounts on either side of any frame size S811+ soft starter to provide additional printed circuit board cooling in high ambient operating temperatures.

Cooling Fan Kit

Description	Catalog Number
Fan kit	EMM18

Product Overview

Drives Selection Guide



Description	M-Max Machinery Drives			SVX9000 Drives					
	Page V9-T2-66			Page V9-T2-68					
Frame	FS1	FS2	FS3	FR4	FR5	FR6	FR7	FR8	FR9
Dimensions (in Inches)									
Height	6.16	7.68	10.33	12.9	16.5	2.2	24.8	30.1	45.3
Width	2.58	3.54	3.94	5	5.6	7.6	9.3	11.5	18.9
Depth	4.02	4.13	4.41	7.5	8.4	9.3	10.1	13.5	13.4
I/O	Six digital inputs Two analog inputs (V and mA) One analog output One digital output Two relay outputs RS-485 interface (Modbus RTU)			Six digital inputs Two analog inputs (V and mA) Two digital outputs, form C relays One digital output, open collector One analog output Varied communication options					

2.5

Motor Control and Protection

Drives

2

M-Max Machinery Drive



Features

- Ease of use—plug and play, start-up wizard, advanced diagnostic capability, copy/paste parameters without powering drive
- Compact, space-saving design
- Availability—short lead-times, stocked at multiple locations
- Aftermarket support organization with industry-leading drive specialists for pre- and post-sale support
- Rugged and reliable—50°C rating, 150% overload for one min., 200% starting current for two secs. in every 20 sec. period, conformal coated boards, two year warranty
- RoHS compliance

Catalog Number Selection

M-Max™ Machinery Drive

Machinery Drive

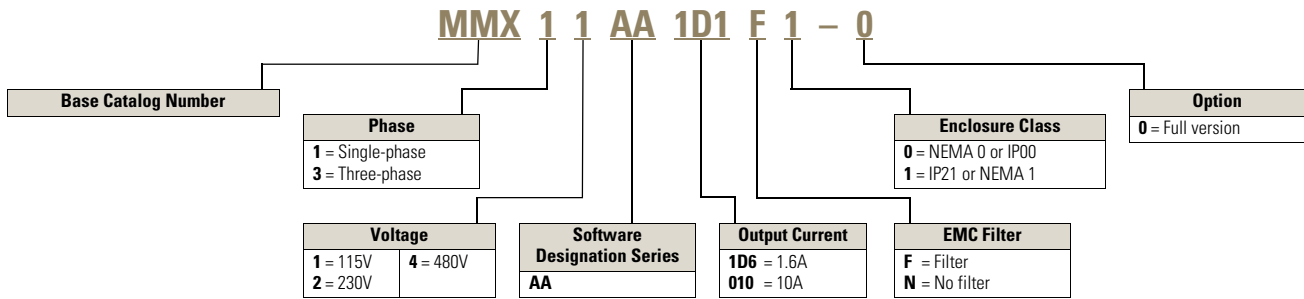

Product Selection

M-Max Machinery Drive

P (kW)	P (hp)	I _N (A)	Catalog Number
Input 115V Single-Phase		Out 230V Three-Phase	
0.25	0.33	1.7	MMX11AA1D7N0-0
0.37	0.5	2.4	MMX11AA2D4N0-0
0.55	0.75	2.8	MMX11AA2D8N0-0
0.75	1	3.7	MMX11AA3D7N0-0
1.1	1.5	4.8	MMX11AA4D8F0-0
Input 230V Single-Phase		Out 230V Three-Phase	
0.25	0.33	1.7	MMX12AA1D7F0-0
0.37	0.5	2.4	MMX12AA2D4F0-0
0.55	0.75	2.8	MMX12AA2D8F0-0
0.75	1	3.7	MMX12AA3D7F0-0
1.1	1.5	4.8	MMX12AA4D8F0-0
1.5	2	7	MMX12AA7D0F0-0
2.2	3	9.6	MMX12AA9D6F0-0
Input 230V Three-Phase		Out 230V Three-Phase	
0.25	0.33	1.7	MMX32AA1D7N0-0
0.37	0.5	2.4	MMX32AA2D4N0-0
0.55	0.75	2.8	MMX32AA2D8N0-0
0.75	1	3.7	MMX32AA3D7N0-0
1.1	1.5	4.8	MMX32AA4D8F0-0
1.5	2	7	MMX32AA7D0F0-0
2.2	3	11	MMX32AA011F0-0

P (kW)	P (hp)	I _N (A)	Catalog Number
Input 480V Three-Phase		Out 480V Three-Phase	
0.37	0.5	1.3	MMX34AA1D3F0-0
0.55	0.75	1.9	MMX34AA1D9F0-0
0.75	1	2.4	MMX34AA2D4F0-0
1.1	1.5	3.3	MMX34AA3D3F0-0
1.5	2	4.3	MMX34AA4D3F0-0
2.2	3	5.6	MMX34AA5D6F0-0
3	4	7.6	MMX34AA7D6F0-0
4	5.5	9	MMX34AA9D0F0-0
5.5	7.5	12	MMX34AA012F0-0
7.5	10	14	MMX34AA014F0-0
Input 575V Three-Phase		Out 575V Three-Phase	
1	1.7	2	MMX35AA1D7N0-0
2	2.7	3.6	MMX35AA2D7N0-0
3	3.9	5	MMX35AA3D9N0-0
5	6.1	7.6	MMX35AA6D1N0-0
7.5	9	10.4	MMX35AA9D0N0-0

Accessories

Kits

Description	Catalog Number
Drive to PC communication module	MMX-COM-PC
Type 1 and IP21 kit for Frame 1	MMX-IP21-FS1
Type 1 and IP21 kit for Frame 2	MMX-IP21-FS2
Type 1 and IP21 kit for Frame 3	MMX-IP21-FS3

Optional Communication Modules

Description	Catalog Number
Communication adapter kit	MMX-NET-XA
CANopen network card	XXM-NET-CO-A
PROFIBUS DP network card with serial connection	XXM-NET-PS-A
PROFIBUS DP network card with sub-D connection	XXM-NET-PD-A
DeviceNet network card	XXM-NET-DN-A

SVX9000 Drives



Features

- Integrated 3% line reactors standard on drives from FR4 through FR9
- EMI/RFI filters standard up to 200 hp I_H 480V, 100 hp I_H 230V
- Quick start wizard built into the programming of the drive ensures a smooth start-up
- LOCAL/REMOTE operation from keypad
- Copy/paste function allows transfer of parameter settings from one drive to the next
- Standard Type 12 keypad on all drives
- Hand-held auxiliary 240V power supply allows programming/monitoring of control module without applying full power to the drive

Catalog Number Selection

SVX9000 Drives

SVX9000

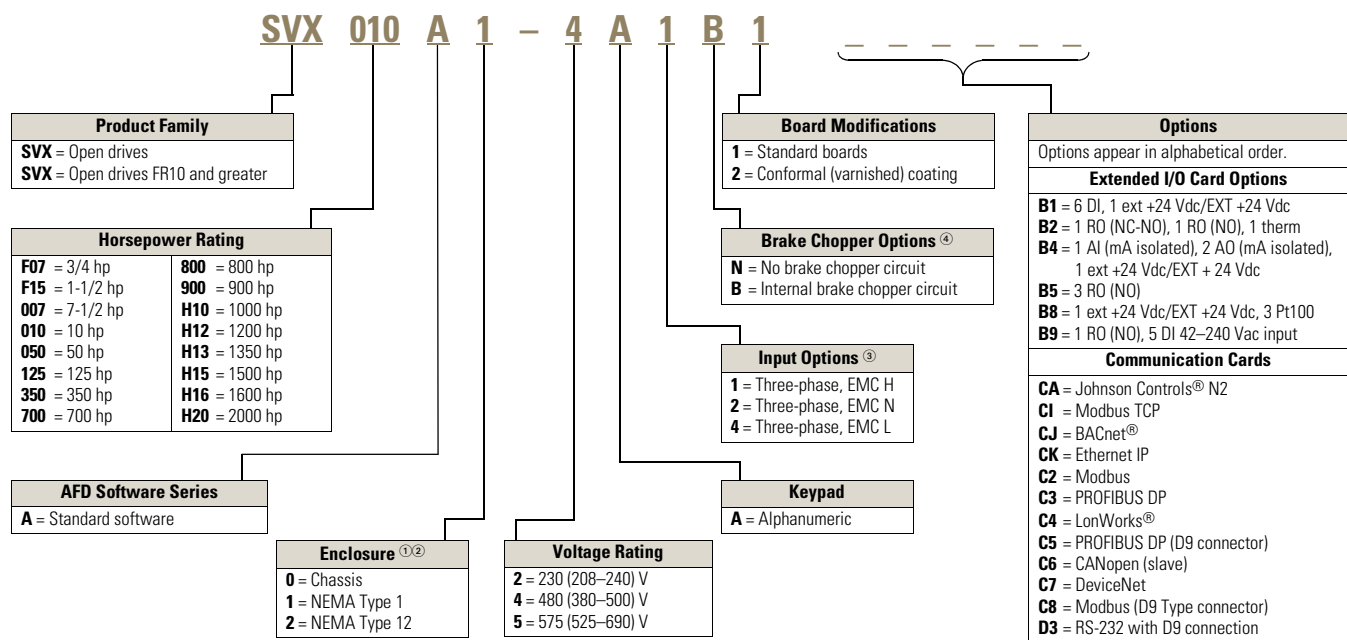

Notes

- ① 480V drives 250 hp (IH) and larger are available with enclosure style 0 (chassis); 690V drives 200 hp (IH) and larger are available with enclosure style 0 (chassis).
- ② 480V and 690V FR10 freestanding drives are available with enclosure style 1 (NEMA Type 1) and enclosure style 2 (NEMA Type 12). FR11 freestanding drives only available with enclosure style 1 (NEMA Type 1).
- ③ All 230V drives and 480V drives up to 200 hp (IH) are only available with input option 1 (EMC level H). 480V drives 250 hp (IH) or larger are available with input option 2 (EMC level N). 480V drives are available with input option 4 (EMC level L). 575V drives 200 hp (IH) or larger are only available with input option 2. 575V drives up to 150 hp (IH) are only available with input option 4 (EMC level L).
- ④ 480V drives up to 30 hp (IH) are only available with brake chopper option B. 480V drives 40 hp (IH) or larger come standard with brake chopper option N. 230V drives up to 15 hp (IH) are only available with brake chopper option B. 230V drives 20 hp or larger come standard with brake chopper option N. All 575V drives come standard without brake chopper option (N). N = No brake chopper.

Product Selection

208–240V, Type 1 Drive

Frame Size	Delivery Code	hp (I _H)	Current (I _H)	hp (I _L)	Current (I _L)	Catalog Number
FR4	W	3/4	3.7	1	4.8	SVXF07A1-2A1B1
		1	4.8	1-1/2	6.6	SVX001A1-2A1B1
		1-1/2	6.6	2	7.8	SVXF15A1-2A1B1
		2	7.8	3	11	SVX002A1-2A1B1
		3	11	—	12.5	SVX003A1-2A1B1
FR5	W	—	12.5	5	17.5	SVX004A1-2A1B1
		5	17.5	7-1/2	25	SVX005A1-2A1B1
		7-1/2	25	10	31	SVX007A1-2A1B1
FR6	W	10	31	15	48	SVX010A1-2A1B1
		15	48	20	61	SVX015A1-2A1B1
FR7	W	20	61	25	75	SVX020A1-2A1N1
		25	75	30	88	SVX025A1-2A1N1
		30	88	40	114	SVX030A1-2A1N1
FR8	W	40	114	50	140	SVX040A1-2A1N1
		50	140	60	170	SVX050A1-2A1N1
		60	170	75	205	SVX060A1-2A1N1
FR9	W	75	205	100	261	SVX075A1-2A1N1
		100	261	—	—	SVX100A1-2A1N1

525–690V, Type 1 Drive

Frame Size	Delivery Code	hp (I _H)	Current (I _H)	hp (I _L)	Current (I _L)	Catalog Number
FR6	W	2	3.33	3	4.5	SVX002A1-5A4N1
		3	4.5	—	5.5	SVX003A1-5A4N1
		—	5.5	5	7.5	SVX004A1-5A4N1
		5	7.5	7-1/2	10	SVX005A1-5A4N1
		7-1/2	10	10	13.5	SVX007A1-5A4N1
		10	13.5	15	18	SVX010A1-5A4N1
		15	18	20	22	SVX015A1-5A4N1
		20	22	25	27	SVX020A1-5A4N1
		25	27	30	34	SVX025A1-5A4N1
		FR7	W	30	34	40
40	41			50	52	SVX040A1-5A4N1
FR8	W	50	52	60	62	SVX050A1-5A4N1
		60	62	75	80	SVX060A1-5A4N1
		75	80	100	100	SVX075A1-5A4N1
FR9	W	100	100	125	125	SVX100A1-5A4N1
		125	125	150	144	SVX125A1-5A4N1
		150	144	—	170	SVX150A1-5A4N1
		—	170	200	208	SVX175A1-5A4N1

380–500V, Type 1 Drive

Frame Size	Delivery Code	hp (I _H)	Current (I _H)	hp (I _L)	Current (I _L)	Catalog Number
FR4	W	1	2.2	1-1/2	3.3	SVX001A1-4A1B1
		1-1/2	3.3	2	4.3	SVXF15A1-4A1B1
		2	4.3	3	5.6	SVX002A1-4A1B1
		3	5.6	5	7.6	SVX003A1-4A1B1
		5	7.6	—	9	SVX005A1-4A1B1
		—	9	7-1/2	12	SVX006A1-4A1B1
FR5	W	7-1/2	12	10	16	SVX007A1-4A1B1
		10	16	15	23	SVX010A1-4A1B1
		15	23	20	31	SVX015A1-4A1B1
FR6	W	20	31	25	38	SVX020A1-4A1B1
		25	38	30	46	SVX025A1-4A1B1
		30	46	40	61	SVX030A1-4A1B1
FR7	W	40	61	50	72	SVX040A1-4A1N1
		50	72	60	87	SVX050A1-4A1N1
		60	87	75	105	SVX060A1-4A1N1
FR8	W	75	105	100	140	SVX075A1-4A1N1
		100	140	125	170	SVX100A1-4A1N1
		125	170	150	205	SVX125A1-4A1N1
FR9	W	150	205	200	261	SVX150A1-4A1N1
		200	245	250	300	SVX200A1-4A1N1

Accessories

Option Board Kits

2

Option Kit Description ^①	Allowed Slot Locations ^②	Field Installed Catalog Number	Factory Installed Option Designator	SVX Ready Programs Basic
Standard I/O Cards				
2 RO (NC/NO)	B	OPTA2	—	X
6 DI, 1 DO, 2 AI, 1AO, 1 +10 Vdc Ref, 2 Ext +24 Vdc/Ext +24 Vdc	A	OPTA9	—	X
Extended I/O Card Options				
2 RO, therm—SPX only	B	OPTA3	A3	—
Encoder low volt +5V/15V/24V—SPX only	C	OPTA4	A4	—
Encoder high volt +15V/24V—SPX only	C	OPTA5	A5	—
Double encoder—SPX only	C	OPTA7	A7	X
6 DI, 1 DO, 2 AI, 1 AO—SPX only	A	OPTA8	A8	—
3 DI (encoder 10–24V), out +15V/+24V, 2 DO (pulse+direction)—SPX only	C	OPTAE	AE	X
6 DI, 1 ext +24 Vdc/Ext +24 Vdc	B, C, D , E	OPTB1	B1	—
1 RO (NC/NO), 1 RO (NO), 1 therm	B, C, D , E	OPTB2	B2	—
1 AI (mA isolated), 2 AO (mA isolated), 1 Ext +24 Vdc/Ext +24 Vdc	B, C, D , E	OPTB4	B4	X
3 RO (NO)	B, C, D , E	OPTB5	B5	—
1 Ext +24 Vdc/Ext +24 Vdc, 3 Pt100	B, C, D , E	OPTB8	B8	—
1 RO (NO), 5 DI 42–240 Vac input	B, C, D , E	OPTB9	B9	—
Communication Cards				
Modbus	D, E	OPTC2	C2	X
Johnson Controls N2 ^③	D, E	OPTC2	CA	—
Modbus TCP	D, E	OPTCI	CI	X
BACnet	D, E	OPTCJ	CJ	X
Ethernet IP	D, E	OPTCK	CK	X
PROFIBUS DP	D, E	OPTC3	C3	X
LonWorks	D, E	OPTC4	C4	X
PROFIBUS DP (D9 connector)	D, E	OPTC5	C5	X
DeviceNet	D, E	OPTC7	C7	X
Modbus (D9 type connector)	D, E	OPTC8	C8	X
Adapter—SPX only	D, E	OPTD1	D1	X
Adapter—SPX only	D, E	OPTD2	D2	X
RS-232 with D9 connection	D, E	OPTD3	D3	X
Keypad				
9000X series local/remote keypad (replacement keypad)	—	KEYPAD-LOC/REM	—	—
9000X series remote mount keypad unit (keypad not included, includes 10 ft cable, keypad holder, mounting hardware)	—	OPTRMT-KIT-9000X	—	—
9000X Series RS-232 cable, 13 ft	—	PP00104	—	—

Notes

^① AI = Analog Input; AO = Analog Output, DI = Digital Input, DO = Digital Output, RO = Relay Output.

^② Option card must be installed in one of the slots listed for that card. Slot indicated in bold is the preferred location.

^③ OPTC2 is a multi-protocol option card.

Miscellaneous Options

Description	Catalog Number
9000XDrive A PC-based tool for controlling and monitoring of the SVX9000. Features include: loading parameters that can be saved to a file or printed, setting references, starting and stopping the motor, monitoring signals in graphical or text form, and real-time display. To avoid damage to the drive or computer, SVDriveable must be used.	9000XDRIVE
SVDriveable 6 ft (1.8m) RS-232 cable (22 gauge) with a 7-pin connector on each end. Should be used in conjunction with the 9000XDrive option to avoid damage to the SVX9000 or computer. The same cable can be used for downloading specialized applications to the drive.	SVDRIVECABLE

NEMA Type 12 Conversion Kit

Note: The NEMA Type 12 kit option is used to convert a NEMA Type 1 to a NEMA Type 12 drive. The NEMA Type 12 kit consists of a metal drive shroud, fan kit for some frames, adapter plate and plugs.

Frame Size	Delivery Code	Approximate Dimensions in Inches (mm)			Approximate Weight in lb (kg)	Catalog Number
		Length	Width	Height		
FR4	W	13 (330)	7 (178)	4 (102)	4 (1.8)	OPTN12FR4
FR5	W	16 (406)	8 (203)	7 (178)	5 (2.3)	OPTN12FR5
FR6	W	21 (533)	10 (254)	5 (127)	7 (3.2)	OPTN12FR6

Relays



easy Programmable Relay



XC152 PLCs



XV HMI-PLCs



Preset Counters



Hour Meters



Encoders



3.1 Relays

Product Overview	V9-T3-2
Terminal Block Relays	V9-T3-8
General Purpose Plug-In Relays	V9-T3-9
General Purpose Type AA Relays	V9-T3-23
XTRE Control Relays	V9-T3-24
Solid-State Relays	V9-T3-26
TR Series Timing Relays	V9-T3-29

3.2 Programmable Controllers

Product Overview	V9-T3-33
Fusion Integrated Machine Controller	V9-T3-36
easy Programmable Relays	V9-T3-37
easy802/806 Programmable Relays with SmartWire-DT	V9-T3-41
XC152 PLCs with and without SmartWire-DT	V9-T3-42
XV Series HMI-PLCs with and without SmartWire-DT	V9-T3-44
ELC Series Programmable Logic Controllers	V9-T3-46

3.3 Preset Counters

Product Overview	V9-T3-49
1/16 DIN LCD Preset Counter	V9-T3-50
1/8 DIN Eclipse Series Preset Counter	V9-T3-51

3.4 Ratemeters

Product Overview	V9-T3-52
Courier Series Battery Powered Ratemeter	V9-T3-53
Eclipse Series 1/8 DIN LED Ratemeter	V9-T3-54

3.5 Hour Meters

Product Overview	V9-T3-55
Electromechanical Hour Meters	V9-T3-56
Electronic LCD Hour Meters	V9-T3-57

3.6 Totalizers

Product Overview	V9-T3-58
Electromechanical Totalizers	V9-T3-59
Electronic 1/32 DIN Totalizers	V9-T3-60
Electronic Courier Series Battery Powered LCD Totalizers	V9-T3-61
Electronic 1/8 DIN LED Totalizers	V9-T3-62

3.7 Encoders

Product Overview	V9-T3-63
Shaft Encoders	V9-T3-64

For our complete product offering, see Volume 7—Logic Control, Operator Interface and Connectivity Solutions, CA08100008E and PG05400001E

Product Overview

Relays Selection Guide



3

Description	XR Series Terminal Block Relays			D1 Series	D2 Series		
	Page V9-T3-8			Page V9-T3-9	Page V9-T3-11		
Approvals							
Features	Pluggable relay allows easy field replacement, LED indicator standard, functional plug-in bridges available Only 6.2 mm wide for SP and 14 mm wide for DP DIN rail mounting			Polycarbonate cover Indicator lamp and pushbutton available Panel and DIN mounting		Polycarbonate cover Indicator lamp and pushbutton available Panel, DIN and flange mounting Latching	
Contact Data							
Configuration	SPDT	DPDT	OctoCoupler	SPDT	DPDT	DPDT Latching	4PDT
Maximum allowable load	6A or 10A	6A	2A	20A	10A	10A	10A
Material	—			Silver alloy	Silver alloy		
Dielectric strength between poles	—			1500V	1500V		
Coil Data							
AC	24 Vac or 120 Vac			6–240 Vac	6–240 Vac		
DC	12, 24, 110 Vdc			6–110 Vdc	6–110 Vdc		
Power							
VA (Vac)	1.5			0.9 VA	1.2 VA		
Watts (Vdc)	0.12			0.7 Watts	0.9 Watts		
General Data							
Ambient temperature							
Storage	—			–40° to 185°F (–40° to 85°C)	–40° to 185°F (–40° to 85°C)		
Operational	–4° to 140°F (–20° to 60°C)			–40° to 131°F (–40° to 55°C)	–40° to 131°F (–40° to 55°C)		
Response time	Available upon request			20 milliseconds	20 milliseconds		
Life							
Mechanical operations	20 million			10 million	10 million		
Electrical operations	—			100,000	200,000		

For our complete product offering, see Volume 7—Logic Control, Operator Interface and Connectivity Solutions, CA08100008E and PG05400001E.

Relays Selection Guide, continued



Description	D3 Series		D4 Series		D5 Series	
	Page V9-T3-13		Page V9-T3-15		Page V9-T3-16	
Approvals						
Features	Polycarbonate cover Indicator lamp and pushbutton available Panel and DIN mounting 8- or 11-pin octal plug-in Latching (D3PR version)		Polycarbonate cover Indicator lamp available Panel and DIN mounting Socket has built-in hold-down spring		Polycarbonate cover Indicator lamp and pushbutton available Panel, DIN and PC board mounting	
Contact Data						
Configuration		DPDT	3PDT	SPDT	DPDT	DPDT 3PDT
Maximum allowable load	16A	16A	16A	10A at 250 Vac	5A at 240 Vac	16A 16A
Material	Silver alloy		AgCdO		Silver alloy	
Dielectric strength between poles	1500V		5000V		1500V	
Coil Data						
AC	6–240 Vac		6–240 Vac		6–240 Vac	
DC	6–110 Vdc		6–110 Vdc		6–110 Vdc	
Power						
VA (Vac)	3 VA, 1.4 Watts (D3PR and DPF)		0.9 VA		3 VA	
Watts (Vdc)	2 VA 1.64 Watts (D3PR5 latching)		0.5 Watts		1.4 Watts	
General Data						
Ambient temperature						
Storage	–40° to 185°F (–40° to 85°C)		–40° to 158°F (–40° to 70°C)		–40° to 185°F (–40° to 85°C)	
Operational	–40° to 131°F (–40° to 55°C)		–40° to 158°F (–40° to 70°C)		–40° to 131°F (–40° to 55°C)	
Response time	20 milliseconds		15 milliseconds		206 milliseconds	
Life						
Mechanical operations	5 million (D3PR and D3PF) 10 million (D3PR5 latching)		10 million		5 million	
Electrical operations	100,000		100,000		100,000	

For our complete product offering, see Volume 7—Logic Control, Operator Interface and Connectivity Solutions, CA08100008E and PG05400001E.

Relays Selection Guide, continued



3

Description	D7 Series				D8 Series		D9 Series	
	Page V9-T3-18				Page V9-T3-20		Page V9-T3-22	
Approvals								
Features	Polycarbonate cover Indicator lamp and pushbutton available Panel, DIN and flange mounting				Dust cover Panel, DIN and flange mounting Quick-connect and screw terminals		Dust cover Pushbutton available Panel mounting Screw terminals	
Contact Data								
Configuration							4PST	
	SPDT	DPDP	3PDT	4PDT	SPST-NO	DPST-NO	NO	NC
Maximum allowable load	20A	15A	15A	15A	30A at 220 Vac	25A at 220 Vac	25A at 220 Vac	8A at 220 Vac
Material	Silver alloy				AgCdO		AgCdO	
Dielectric strength between poles	1500V	1500V	2500V	2500V	4000V		4000V	
Coil Data								
AC	6–240 Vac				6–240 Vac		24–240 Vac	
DC	6–110 Vdc				12–24 Vdc		12–110 Vdc	
Power								
VA (Vac)	1.2 VA	1.2 VA	1.5 VA	1.5 VA	2.5 VA		2.6 VA	
Watts (Vdc)	0.9 Watts	0.9 Watts	1.4 Watts	1.5 Watts	1.9 Watts		2.0 Watts	
General Data								
Ambient temperature								
Storage	–40° to 185°F (–40° to 85°C)				–4° to 185°F (–20° to 85°C)		–13° to 140°F (–25° to 60°C)	
Operational	–40° to 131°F (–40° to 55°C)				–4° to 131°F (–20° to 55°C)		–13° to 140°F (–25° to 60°C)	
Response time	20 milliseconds (30 milliseconds for latching)				30 milliseconds		50 milliseconds	
Life								
Mechanical operations	10 million				5 million		1 million	
Electrical operations	100,000	100,000	200,000	200,000	100,000		100,000	

For our complete product offering, see Volume 7—Logic Control, Operator Interface and Connectivity Solutions, CA08100008E and PG05400001E.

Relays Selection Guide, continued



Description	Type AA Series Page V9-T3-23	XTRE Series Page V9-T3-24	D93 Series Page V9-T3-26
Approvals			
Features	Available blowout magnets for high DC switching Available auxiliary switches Combo head screws for simple hook-up Riveted construction for long service life	Four-pole configurations IP20 finger and back-of-hand proof Positively driven contacts between the relay and auxiliary contact modules as well as within the auxiliary contact modules	All solid-state circuitry with no moving parts to wear Compact, panel mounting for flexible installation Isolated input and output terminals to protect the system from electrical noise Internal snubber circuitry to protect the SSR from transients
Contact Data			
Configuration	DPDT	NO-NC variations in a four-pole relay plus four-pole auxiliary module	SPST-NO (Triac, Zero-cross or MOSFET)
Maximum allowable load	40A	16A	10–75A
Material	Silver cadmium oxide, gold flashed	—	—
Dielectric strength between pole	1500V	6000 Vac	4000 Vac
Coil Data			
AC	6–600 Vac	12–600 Vac	90–280 Vac
DC	6–220 Vdc	24–240 Vdc	3–32 Vdc
Power			
VA (Vac)	10 VA	3.3 VA	Available upon request
Watts (Vdc)	4 Watts	3 Watts	Available upon request
General Data			
Ambient temperature			
Storage	–40° to 185°F (–40° to 85°C)	–40° to 176° (–40° to 80°C)	–40° to 100°C
Operational	–40° to 131°F (–40° to 55°C)	–13° to 140°F (–25° to 60°C)	–40° to 80°C
Response time	35/50 milliseconds	12/31 milliseconds	Available upon request
Life			
Mechanical operations	—	20 million	—
Electrical operations	6000	100,000	—

For our complete product offering, see Volume 7—Logic Control, Operator Interface and Connectivity Solutions, CA08100008E and PG05400001E.

Relays Selection Guide, continued



Description	D96 Series	D99 Series	Universal TR Series
	Page V9-T3-27	Page V9-T3-28	Page V9-T3-29
Approvals			
Features	<p>All solid-state circuitry has no moving parts to wear</p> <p>Integral heat sink eliminates the need for added accessories and installation</p> <p>Flexible mounting allows DIN rail or panel mounting without additional hardware or tools</p> <p>Isolated input and output terminals protect the system from electrical noise</p> <p>Internal snubber circuitry protects the SSR from transients</p>	<p>All solid-state circuitry has no moving parts to wear</p> <p>Integral heat sink eliminates the need for added accessories and installation</p> <p>Flexible mounting allows DIN rail or panel mounting without additional hardware or tools</p> <p>Isolated input and output terminals protect the system from electrical noise</p> <p>Internal snubber circuitry protects the SSR from transients</p>	<p>Multiple user-selectable timing functions and timing ranges in a single unit reduce product variations and stock keeping units (SKUs)</p> <p>Universal input voltages from 12 or 24–240 Vac or Vdc eliminate the need to order and stock separate coil voltages</p> <p>Compact, DIN rail mountable case reduces panel size</p> <p>Advanced LED indication makes troubleshooting easy</p> <p>Staggered terminal locations allow access to lower-level terminals after wiring</p> <p>SPDT or DPDT contacts with 8A ratings</p>
Contact Data			
Configuration	SPST-NO (DC switch, zero-cross or random)	SPST-NO (zero cross)	SPDT and DPDT
Maximum allowable load	8–15A	10–40A	8A
Material	—	—	—
Dielectric strength between pole	2500 (4000 on random) Vac	4000 Vac	—
Coil Data			
AC	90–280 Vac	90–280 Vac	24–240 Vac SPDT, 12–240 Vac DPDT
DC	3–32 Vdc (3.5–32 Vdc on DC switch)	3–32 Vdc	24–240 Vdc SPDT, 12–240 Vdc DPDT
Power			
VA (Vac)	Available upon request	Available upon request	4 VA SPDT, 6 VA DPDT
Watts (Vdc)	Available upon request	Available upon request	1.5 Watts SPDT, 2W DPDT
General Data			
Ambient temperature			
Storage	–40° to 100°C	–40° to 100°C	–25° to 70°C
Operational	–30° to 80°C	–30° to 80°C	–25° to 55°C
Response time	Available upon request	Available upon request	100 ms
Life			
Mechanical operations	—	—	20,000,000
Electrical operations	—	—	200,000

For our complete product offering, see Volume 7—Logic Control, Operator Interface and Connectivity Solutions, CA08100008E and PG05400001E.

Relays Selection Guide, continued



Description	TMR5 Series Page V9-T3-30	TMR6 Series Page V9-T3-31	TMRP Series Page V9-T3-32
Approvals			
Features	<p>Various configurations available with fixed or adjustable time delays</p> <p>Single operating voltage for simple set-up</p> <p>Plugs in standard 8- or 11-pin octal sockets</p>	<p>Provides OFF delay function without requiring input voltage during OFF time delay</p> <p>Duplicates operation of pneumatic OFF delay timers</p> <p>Each unit has eight timing ranges built in, covering 0.05 seconds to 30 minutes</p> <p>Selecting a range is easy using a rotary switch (no math is required or DIP switches to set)</p> <p>Uses industry-standard 8-pin octal socket</p> <p>10A DPDT output contacts</p>	<p>Multiple user-selectable timing functions and timing ranges in a single unit reduce product variations and stock keeping units (SKUs)</p> <p>Universal input voltages from 12–240 Vac/Vdc eliminate the need to order and stock separate coil voltages</p> <p>Timing ranges up to 9990 hours</p> <p>Dual LED indication makes troubleshooting easy</p> <p>Flexible design for backpanel, through-panel (45 mm x 45 mm cutout), or DIN rail mounting</p> <p>SPDT or DPDT contacts with 12A ratings</p> <p>Plastic dust cover keeps out contaminants and eliminates accidental set point changes</p> <p>Use with standard Eaton D3 sockets</p>
Contact Data			
Configuration	DPDT	DPDT	SPDT and DPDT
Maximum allowable load	10A	10A	12A
Material	—	—	—
Dielectric strength between pole	2000V	2000V	—
Coil Data			
AC	12–240 Vac	24, 120 or 240 Vac	12–240 Vac
DC	12–240 Vdc	24, 120 or 240 Vdc	12–240 Vdc
Power			
VA (Vac)	2 VA	2 VA	2.5 VA
Watts (Vdc)	—	—	2 Watts
General Data			
Ambient temperature			
Storage	—	—	–40° to 85°C
Operational	–4° to 149°F (–20° to 65°C)	–18° to 150°F (–28° to 65°C)	–10° to 55°C
Response time	100 milliseconds	—	25 milliseconds
Life			
Mechanical operations	10 million	2,000,000	10 million
Electrical operations	100,000	100,000	100000

For our complete product offering, see Volume 7—Logic Control, Operator Interface and Connectivity Solutions, CA08100008E and PG05400001E.

3.1

Logic Devices

Relays

3

Terminal Block Relays



Features

- Pluggable relay allows for field replacement
- Functional plug-in bridges
- LED status indication
- Only 6.2 mm wide for single pole versions, 14 mm wide for double pole

Catalog Number Selection

Terminal Block Relays

Terminal Block Relays

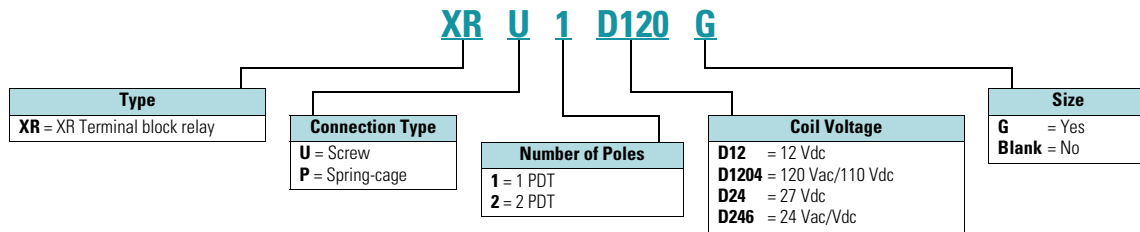

Product Selection

Standard Terminal Block Relays

Contacts	Rated Current	Supply Voltage	Standard Pack	Catalog Number
1PDT Screw Connection				
No	6A	12 Vdc	10	XRU1D12
No	6A	120 Vac/110 Vdc	10	XRU1D120U
Yes	6A	120 Vac/110 Vdc	10	XRU1D120UG
No	6A	24 Vdc	10	XRU1D24
No	6A	24 Vac/Vdc	10	XRU1D24U
Yes	6A	24 Vac/Vdc	10	XRU1D24UG
1PDT Spring-Cage Connection				
No	6A	12 Vdc	10	XRP1D12
No	6A	120 Vac/110 Vdc	10	XRP1D120U
No	6A	24 Vdc	10	XRP1D24
No	6A	24 Vac/Vdc	10	XRP1D24U
DPDT Screw Connection				
No	6A	12 Vdc	10	XRU2D12
No	6A	120 Vac/110 Vdc	10	XRU2D120U
No	6A	24 Vdc	10	XRU2D24
No	6A	24 Vac/Vdc	10	XRU2D24U

General Purpose Plug-In Relays—D1 Series



Features

- Compact relay capable of breaking relatively large load currents
- The contact operation can be easily checked by push-to-test button
- Panel and DIN rail mounting
- Flag indicator shows relay status in manual or powered condition
- LED status lamp shows coil “ON” or “OFF” status—ideal for use in low light applications
- Push-to-test button allows for manual operation of relay without the need for coil power
- Lock-down door holds pushbutton and contacts in the operate position when activated
- Finger-grip cover allows operator to remove relays from sockets easily
- ID tag/write label to identify relays in multiple-relay circuits
- Bi-polar LED allows for reverse polarity applications

Catalog Number Selection

General Purpose Plug-In Relays

D1 Series ①

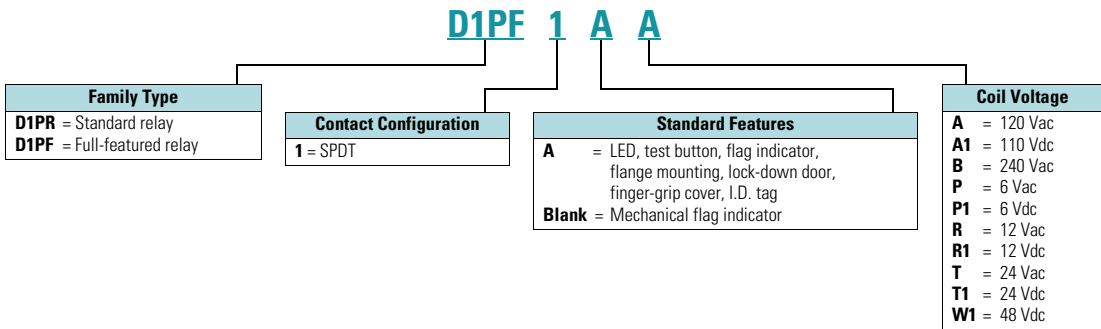

Note

① For deciphering catalog numbers. Do not use for ordering as not all combinations are readily available.

Product Selection

General Purpose Plug-In Relays—D1PR/D1PF

Coil Voltage	Contact Configuration	Coil Resistance (Ohms)	Catalog Number
Full Featured			
6 Vac	SPDT	12.2	D1PF1AP
6 Vdc	SPDT	47	D1PF1AP1
12 Vac	SPDT	46	D1PF1AR
12 Vdc	SPDT	188	D1PF1AR1
24 Vac 50/60 Hz	SPDT	180	D1PF1AT
24 Vdc	SPDT	750	D1PF1AT1
48 Vac	SPDT	720	D1PF1AW
48 Vdc	SPDT	2,600	D1PF1AW1
110 Vdc	SPDT	13,800	D1PF1AA1
120 Vac 50/60 Hz	SPDT	4,430	D1PF1AA
240 Vac 50/60 Hz	SPDT	15,720	D1PF1AB

Coil Voltage	Contact Configuration	Coil Resistance (Ohms)	Catalog Number
Plain Cover			
6 Vac	SPDT	12.2	D1PR1P
6 Vac	SPDT	47	D1PR1P1
12 Vac	SPDT	46	D1PR1R
12 Vac	SPDT	188	D1PR1R1
24 Vac	SPDT	750	D1PR1T1
48 Vac	SPDT	720	D1PR1W
48 Vac	SPDT	2,600	D1PR1W1
110 Vdc	SPDT	13,800	D1PR1A1
120 Vac 50/60 Hz	SPDT	4,430	D1PR1A
240 Vac	SPDT	15,270	D1PR1B

Accessories

D1PR/D1PF Socket and Accessories

Type	Standard Pack	Catalog Number
Socket	10	D1PAA
Flange mount adapter	25	PFC-D11
Metal spring clip	25	PMC-1781

General Purpose Plug-In Relays—D2 Series



Features

- Ultra-high sensitivity relay with quick response
- Designed small, two-pole type break 5A load and four-pole type, 3A load
- High reliability, long life
- Panel, DIN rail and flange mounting
- Small size

Catalog Number Selection

General Purpose Plug-In Relays

D2 Series ①

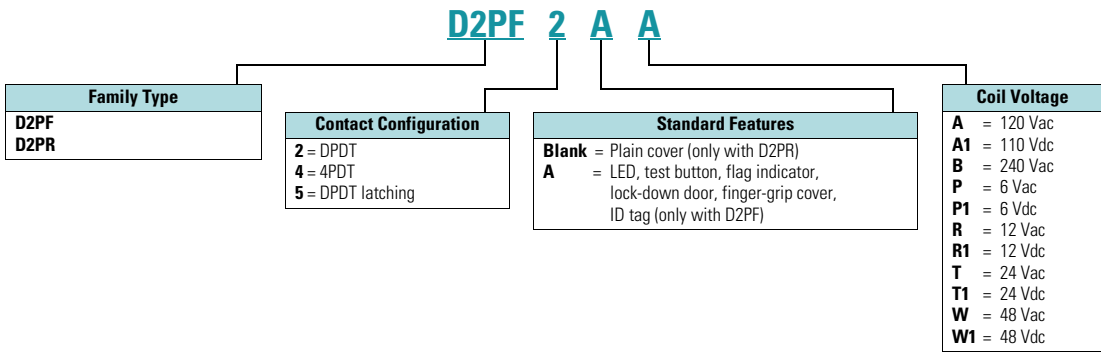

Product Selection

D2PF/D2PR Relay/Socket Quick Reference

Relay Type	Socket	Clip
D2PR2	D2PAL	PWC-D24
D2PF2		PQC-1782
	D2PA6	PQC-1342
D2PR4	D2PAP	PWC-D24
D2PF4		PQC-1782
	D2PA7	PWC-D24
		PQC-1782
	D2PA6	PQC-1342
D2PR5	D2PA4	PYC-A1

Note

① For deciphering catalog numbers.
Do not use for ordering as not all combinations are readily available.

General Purpose Plug-In Relays—D2PR/D2PF

Coil Voltage	Contact Configuration	Coil Resistance (Ohms)	Catalog Number
Full Featured Style			
6 Vac	DPDT	9.6	D2PF2AP
6 Vdc	DPDT	40	D2PF2AP1
12 Vac	DPDT	46	D2PF2AR
12 Vdc	DPDT	160	D2PF2AR1
24 Vac	DPDT	180	D2PF2AT
24 Vdc	DPDT	650	D2PF2AT1
48 Vdc	DPDT	2,600	D2PF2AW1
110/125 Vdc	DPDT	11,000	D2PF2AA1
120 Vac	DPDT	4,430	D2PF2AA
220/240 Vac	DPDT	15,720	D2PF2AB
12 Vac	4PDT	46	D2PF4AR
12 Vdc	4PDT	160	D2PF4AR1
24 Vac	4PDT	180	D2PF4AT
24 Vdc	4PDT	650	D2PF4AT1
48 Vdc	4PDT	2,600	D2PF4AW1
110/125 Vdc	4PDT	11,000	D2PF4AA1
120 Vac	4PDT	4,430	D2PF4AA
220/240 Vac	4PDT	15,720	D2PF4AB

Coil Voltage	Contact Configuration	Coil Resistance (Ohms)	Catalog Number
Plain Cover Style			
6 Vdc	DPDT	40	D2PR2P1
12 Vdc	DPDT	160	D2PR2R1
24 Vac	DPDT	180	D2PR2T
24 Vdc	DPDT	650	D2PR2T1
48 Vdc	DPDT	2,600	D2PR2W1
110/125 Vdc	DPDT	11,000	D2PR2A1
120 Vac	DPDT	4,430	D2PR2A
220/240 Vac	DPDT	15,720	D2PR2B
6 Vac	4PDT	9.6	D2PR4P
6 Vdc	4PDT	40	D2PR4P1
12 Vac	4PDT	46	D2PR4R
12 Vdc	4PDT	160	D2PR4R1
24 Vac	4PDT	180	D2PR4T
24 Vdc	4PDT	650	D2PR4T1
110/125 Vdc	4PDT	11,000	D2PR4A1
120 Vac	4PDT	4,430	D2PR4A
220/240 Vac	4PDT	15,720	D2PR4B

Accessories

D2PF/D2PR Sockets and Accessories

Type	Standard Pack	Catalog Number
Socket	1	D2PAL ①
Socket	10	D2PA6
Socket	1	D2PAP ①
Socket	10	D2PA7 ①
Socket	5	D2PA4
Flange mount adapter	25	PFC-D2D72
Plastic ejector clip	10	PWC-D24
Metal spring clip	25	PQC-1782
Metal spring clip	25	PQC-1342
Hold-down spring	100	PYC-A1

Note

① Protection category (finger safe), EN 60529 IP20.

General Purpose Plug-In Relays—D3 Series



Features

- Compact relay capable of breaking relatively large load currents
- The contact operation can be easily checked by push-to-test button
- Panel and DIN rail mounting
- 8- or 11-pin octal plug-in

Catalog Number Selection

General Purpose Plug-In Relays

D3 Series ①

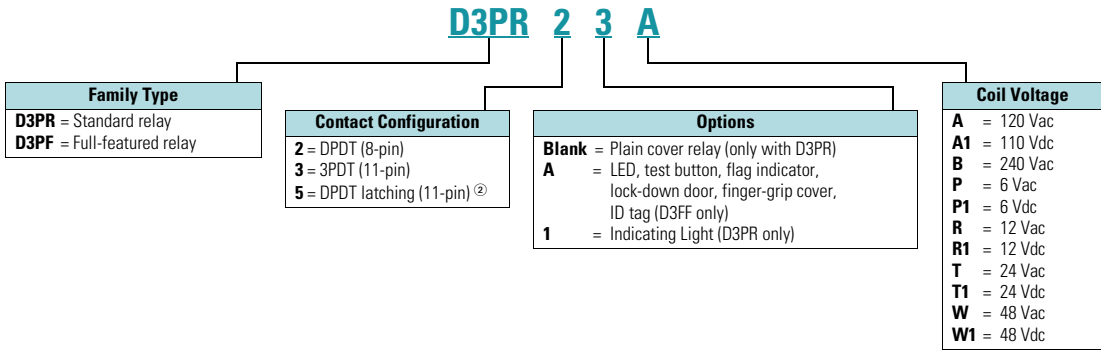

Product Selection

D3 Relay/Socket Quick Reference

Relay Type	Socket	Clip
D3PR2	D3PA6	PQC-1332
D3PF2	D3PAL8	PQC-1351
	D3PA2	PQC-1351
D3PR3	D3PA7	PQC-1332
D3PF3	D3PAL11	PQC-1351
	D3PA3	PQC-1351
D3PR5	D3PA7	PQC-1351
	D3PAL11	PQC-1351
	D3PA3	PQC-1351

Notes

- ① For deciphering catalog numbers. Do not use for ordering as not all combinations are readily available.
- ② D3PR only.

General Purpose Plug-In Relays—D3PR/D2PF

Coil Voltage	Contact Configuration	Coil Resistance (Ohms)	Catalog Number
Full Featured Style			
120 Vac	DPDT	1,700	D3PF2AA
240 Vac	DPDT	7,200	D3PF2AB
12 Vdc	DPDT	120	D3PF2AR1
24 Vdc	DPDT	470	D3PF2AT1
48 Vdc	DPDT	1,800	D3PF2AW1
120 Vac	3PDT	1,700	D3PF3AA
220/240 Vac	3PDT	7,200	D3PF3AB
6 Vdc	3PDT	32	D3PF3AP1
24 Vac	3PDT	72	D3PF3AT
24 Vdc	3PDT	470	D3PF3AT1
48 Vdc	3PDT	1,800	D3PF3AW1
Plain Cover Style			
120 Vac	DPDT	1,700	D3PR2A
110/125 Vdc	DPDT	10,000	D3PR2A1
220/240 Vac	DPDT	7,200	D3PR2B
6 Vac	DPDT	4.2	D3PR2P

Coil Voltage	Contact Configuration	Coil Resistance (Ohms)	Catalog Number
Plain Cover Style, continued			
6 Vdc	DPDT	32	D3PR2P1
12 Vac	DPDT	18	D3PR2R
12 Vdc	DPDT	120	D3PR2R1
24 Vac	DPDT	72	D3PR2T
24 Vdc	DPDT	470	D3PR2T1
48 Vac	DPDT	290	D3PR2W
48 Vdc	DPDT	1,800	D3PR2W1
120 Vac	3PDT	1,700	D3PR3A
110/125 Vdc	3PDT	10,000	D3PR3A1
220/240 Vac	3PDT	7,200	D3PR3B
12 Vac	3PDT	18	D3PR3R
12 Vdc	3PDT	120	D3PR3R1
24 Vac	3PDT	72	D3PR3T
24 Vdc	3PDT	470	D3PR3T1
48 Vdc	3PDT	1,800	D3PR3W1

Accessories

D2PF/D2PR Sockets and Accessories

Type	Standard Pack	Catalog Number
Socket	1	D3PA6 ①
Socket	10	D3PAL8 ①
Socket	10	D3PA2
Socket	1	D3PA7 ①
Socket	10	D3PAL11 ①
Socket	10	D3PA3
Metal spring clip	25	PQC-1332
Metal spring clip	10	PQC-1351

Note

① Protection category (finger safe) EN 60529 IP20.

General Purpose Plug-In Relays—D4 Series



Features

- Slim-styled power relay
- Socket has built-in hold-down clip
- Panel or DIN rail mounting

Catalog Number Selection

General Purpose Plug-In Relays—D4 Series

D4 Series ①

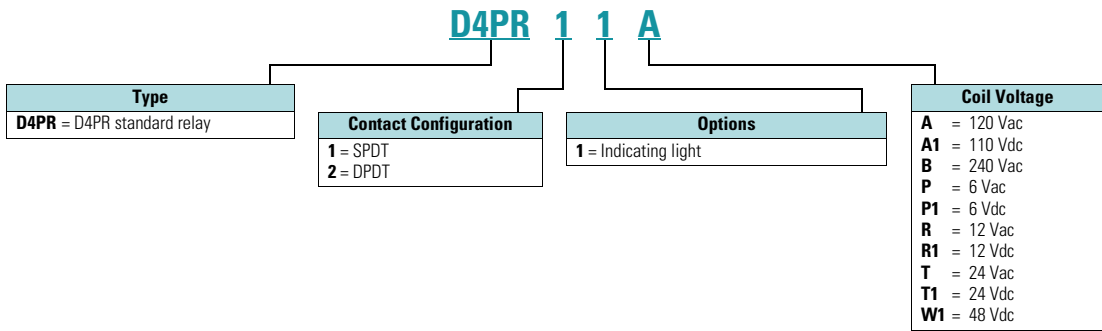

Product Selection

D4 Relay/Socket Quick Reference

Relay Type	Socket	Hold Down Clip
D4PR1	D4PA1	②
D4PR2	D4PA2	②

D4 Series

Coil Voltage ③	Catalog Number
Standard SPDT	
24 Vac	D4PR1T
120 Vac	D4PR1A
24 Vdc	D4PR1T1
SPDT with Indicating Light	
24 Vac	D4PR11T
120 Vac	D4PR11A
24 Vdc	D4PR11T1

Coil Voltage ③	Catalog Number
Standard DPDT	
24 Vac	D4PR2T
120 Vac	D4PR2A
12 Vdc	D4PR2R1
24 Vdc	D4PR2T1
DPDT with Indicating Light	
120 Vac	D4PR21A
24 Vdc	D4PR21T1

Coil Voltage ③	Catalog Number
DIN Rail Sockets	
Single-Pole	D4PA1
Two-Pole	D4PA2
Accessories	
DIN rail end stop	PFP-M

Notes

- ① For deciphering catalog numbers. Do not use for ordering as not all combinations are readily available.
- ② Socket has built-in hold down spring.
- ③ Additional coil voltages available—consult sales office or customer support center.

3.1

Logic Devices

Relays

3

General Purpose Plug-In Relays—D5 Series



Features

- Industrial rated 300V, 15A relay in two-pole and three-pole configurations
- Compact design can be panel or DIN rail mounted

Catalog Number Selection

General Purpose Plug-In Relays—D5 Series

D5 Series ①

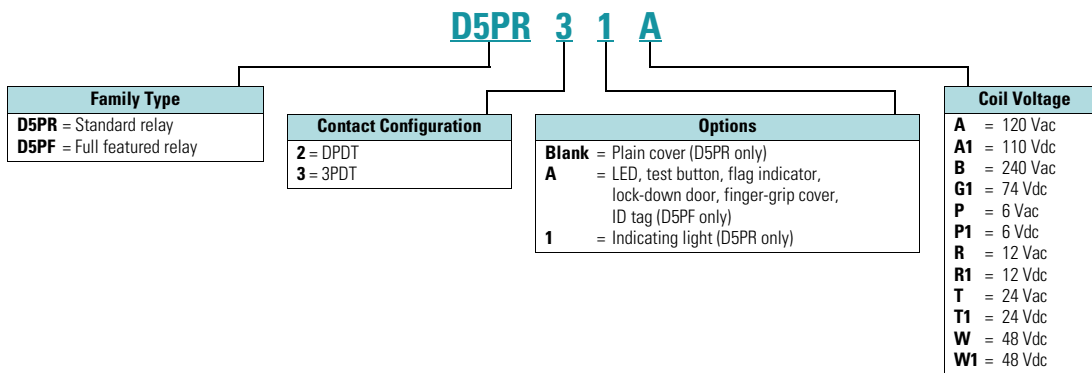

Product Selection

D5 Relay/Socket Quick Reference

Relay Type	Socket	Clip
D5PR2	D5PAL	PQC-1351
D5PF2	D5PA2	PQC-1351
D5PR3	D5PA3L	PQC-1351
D5PF3	D5PA3S	PQC-1351

Note

- ① For deciphering catalog numbers.
Do not use for ordering as not all combinations are readily available.

General Purpose Plug-In Relays—D5

Coil Voltage	Contact Configuration	Coil Resistance (Ohms)	Catalog Number
Full Featured			
120 Vac	DPDT	1,700	D5PF2AA
110/125 Vdc	DPDT	10,000	D5PF2AA1
220/240 Vac	DPDT	7,200	D5PF2AB
12 Vdc	DPDT	120	D5PF2AR1
24 Vac	DPDT	72	D5PF2AT
24 Vdc	DPDT	470	D5PF2AT1
48 Vdc	DPDT	1,800	D5PF2AW1
120 Vac	3PDT	1,700	D5PF3AA
110/125 Vdc	3PDT	10,000	D5PF3AA1
220/240 Vac	3PDT	7,200	D5PF3AB
12 Vdc	3PDT	120	D5PF3AR1
24 Vac	3PDT	72	D5PF3AT
Plain Cover			
120 Vac	DPDT	1,700	D5PR2A
110/125 Vdc	DPDT	10,000	D5PR2A1
220/240 Vac	DPDT	7,200	D5PR2B
74 Vdc	DPDT	4,800	D5PR2G1
6 Vac	DPDT	4.2	D5PR2P

Coil Voltage	Contact Configuration	Coil Resistance (Ohms)	Catalog Number
Plain Cover, continued			
6 Vdc	DPDT	32	D5PR2P1
12 Vac	DPDT	18	D5PR2R
12 Vdc	DPDT	120	D5PR2R1
24 Vac	DPDT	72	D5PR2T
24 Vdc	DPDT	470	D5PR2T1
48 Vac	DPDT	290	D5PR2W
48 Vdc	DPDT	1,800	D5PR2W1
120 Vac	3PDT	1,700	D5PR3A
110/125 Vdc	3PDT	10,000	D5PR3A1
220/240 Vac	3PDT	7200	D5PR3B
74 Vdc	3PDT	4,800	D5PR3G1
6 Vac	3PDT	4.2	D5PR3P
6 Vdc	3PDT	32	D5PR3P1
12 Vac	3PDT	18	D5PR3R
12 Vdc	3PDT	120	D5PR3R1
24 Vac	3PDT	72	D5PR3T
24 Vdc	3PDT	470	D5PR3T1
48 Vdc	3PDT	1,800	D5PR3W

Accessories

D5 Sockets and Accessories

Description	Standard Pack	Catalog Number
Socket	10	D5PAL ①
Socket	10	D5PA2
Socket	10	D5PA3L
Socket	10	D5PA3S
Metal spring clip	10	PQC-1351

Note

① Protection category (finger safe), EN 60529 IP20.

3.1

Logic Devices

Relays

3

General Purpose Plug-In Relays—D7 Series



Features

- Arc barrier equipped relay with high dielectric strength
- Panel, DIN rail and flange mounting

Catalog Number Selection

General Purpose Plug-In Relays—D7 Series

D7 Series ①

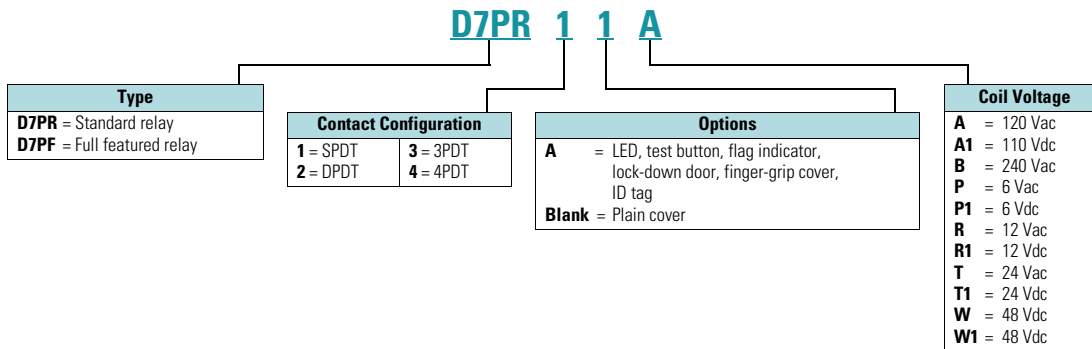

Product Selection

D7 Relay/Socket Quick Reference

Relay Type	Socket/Adapter	Clip
D7PR1	D7PAA	PQC-1342
D7PR2		PQC-1349
D7PF1	D7PA9	PQC-1342
D7PF2	PFC-D2D72	—
D7PR3	D7PAB	PQC-1783 PMC-1783
D7PF3	PFC-D73	—
D7PR4	D7PAD	PQC-1784 PMC-1784
D7PF4	PFC-D74	—

Note

- ① For deciphering catalog numbers.
Do not use for ordering as not all combinations are readily available.

General Purpose Plug-In Relays—D7

Coil Voltage	Contact Configuration	Coil Resistance (Ohms)	Catalog Number
Full Featured			
120 Vac	SPDT	4,430	D7PF1AA
6 Vac	SPDT	9.6	D7PF1AP
6 Vdc	SPDT	40	D7PF1AP1
12 Vac	SPDT	46	D7PF1AR
24 Vdc	SPDT	650	D7PF1AT1
48 Vac	SPDT	788	D7PF1AW
48 Vdc	SPDT	2,600	D7PF1AW1
120 Vac	DPDT	4,430	D7PF2AA
110/125 Vdc	DPDT	11,000	D7PF2AA1
220/240 Vac	DPDT	15,720	D7PF2AB
6 Vac	DPDT	9.6	D7PF2AP
6 Vdc	DPDT	40	D7PF2AP1
12 Vac	DPDT	46	D7PF2AR
12 Vdc	DPDT	160	D7PF2AR1
24 Vac	DPDT	180	D7PF2AT
24 Vdc	DPDT	650	D7PF2AT1
48 Vac	DPDT	788	D7PF2AW
48 Vdc	DPDT	2,600	D7PF2AW1
120 Vac	3PDT	2,770	D7PF3AA
6 Vac	3PDT	6	D7PF3AP
6 Vdc	3PDT	25	D7PF3AP1
12 Vac	3PDT	25.3	D7PF3AR
24 Vac	3PDT	103	D7PF3AT
24 Vdc	3PDT	400	D7PF3AT1
48 Vac	3PDT	412	D7PF3AW
48 Vdc	3PDT	1,600	D7PF3AW1
120 Vac	4PDT	2,220	D7PF4AA
110/125 Vdc	4PDT	7,340	D7PF4AA1
240 Vac	4PDT	9,120	D7PF4AB
6 Vac	4PDT	5.4	D7PF4AP
6 Vdc	4PDT	24	D7PF4AP1
12 Vac	4PDT	21.2	D7PF4AR
12 Vdc	4PDT	96	D7PF4AR1
24 Vac	4PDT	84.5	D7PF4AT
24 Vdc	4PDT	388	D7PF4AT1
48 Vdc	4PDT	1,550	D7PF4AW
48 Vac	4PDT	410	D7PF4AW1

Coil Voltage	Contact Configuration	Coil Resistance (Ohms)	Catalog Number
Plain Cover			
120 Vac	SPDT	4,430	D7PR1A
110/125 Vdc	SPDT	11,000	D7PR1A1
220/240 Vac	SPDT	15,720	D7PR1B
6 Vac	SPDT	9.6	D7PR1P
12 dc	SPDT	160	D7PR1R1
24 Vac	SPDT	180	D7PR1T
24 Vdc	SPDT	650	D7PR1T1
48 Vdc	SPDT	2600	D7PR1W1
120 Vac	DPDT	4,430	D7PR2A
110/125 Vdc	DPDT	11,000	D7PR2A1
220/240 Vac	DPDT	15,720	D7PR2B
6 Vac	DPDT	9.6	D7PR2P
6 Vdc	DPDT	40	D7PR2P1
12 Vac	DPDT	46	D7PR2R
12 Vdc	DPDT	160	D7PR2R1
24 Vac	DPDT	180	D7PR2T
24 Vdc	DPDT	650	D7PR2T1
120 Vac	3PDT	2,770	D7PR3A
240 Vac	3PDT	12,100	D7PR3B
6 Vac	3PDT	6	D7PR3P
12 Vac	3PDT	25.3	D7PR3R
12 Vdc	3PDT	100	D7PR3R1
24 Vac	3PDT	103	D7PR3T
24 Vdc	3PDT	400	D7PR3T1
48 Vdc	3PDT	1,600	D7PR3W1
120 Vac	4PDT	2,220	D7PR4A
110/125 Vdc	4PDT	7,340	D7PR4A1
240 Vac	4PDT	9,120	D7PR4B
6 Vac	4PDT	5.4	D7PR4P
24 Vac	4PDT	84.5	D7PR4T
24 Vdc	4PDT	388	D7PR4T1
48 Vdc	4PDT	1,550	D7PR4W1

Accessories

D7 Sockets and Accessories

Type	Standard Pack	Catalog Number
Socket	—	D7PAA ①
Socket	1	D7PA9
Socket	—	D7PAD ①
Socket	—	D7PAB ①
Flange mount adapter	25	PFC-D2D72
Flange mount adapter	25	PFC-D73
Flange mount adapter	25	PFC-D74

Note

① Protection category (finger safe) EN 60529 IP20.

Type	Standard Pack	Catalog Number
Metal spring clip	25	PQC-1342
Plastic ID clip	10	PQC-1349
Metal spring clip	25	PQC-1784
Plastic ID clip	10	PMC-1784
Hold-down spring	25	PYC-B2
Metal spring clip	10	PQC-1783
Plastic ID clip	10	PMC-1783

3.1

Logic Devices

Relays

3

General Purpose Plug-In Relays—D8 Series



Features

- Allows switching of 25A and 30A loads
- A high-capacity, high-withstand voltage relay compatible with momentary voltage drops
- No contact chattering for momentary voltage drops up to 50% of rated voltage

Catalog Number Selection

General Purpose Plug-In Relays—D8 Series

D8 Series ①

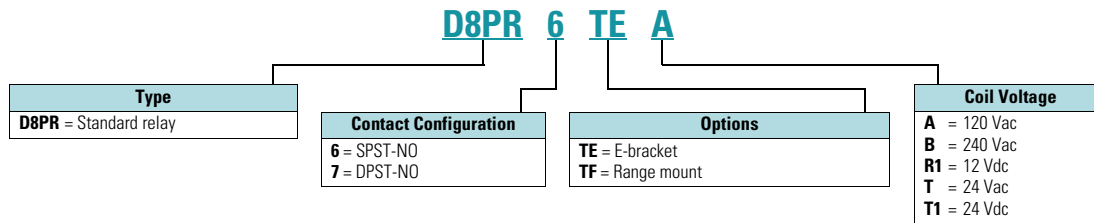

Product Selection

D8 Relay/Socket Quick Reference

Relay Type	Mounting Bracket	Adapter Track/ Panel Mount	Front Connecting Sockets Track/ Panel Mount
D8PR6TE	D8PA5	D8PA1	D8PA2
D8PR7TE	D8PA5	D8PA1	D8PA2

Note

- ① For deciphering catalog numbers.
Do not use for ordering as not all combinations are readily available.

D8 Series

Coil Voltage	Catalog Number
SPST E-Bracket	
24 Vac	D8PR6TET
24 Vdc	D8PR6TET1
SPST Flange Mount	
120 Vac	D8PR6TFA
24 Vdc	D8PR6TFT1
DPST E-Bracket	
120 Vac	D8PR7TEA
DPST Flange Mount	
120 Vac	D8PR7TFA
24 Vdc	D8PR7TFT1

Accessories**D8 Series Sockets and Accessories**

Description	Standard Pack	Catalog Number
Sockets		
DIN rail adapter	10	D8PA1
Screw terminal adapter	10	D8PA2
Bracket adapter	10	D8PA5
Accessory		
DIN rail end stop	100	PFP-M

3.1

Logic Devices

Relays

3

General Purpose Plug-In Relays—D9 Series



Features

- Ideal for three-phase motor control applications
- No contact chattering for momentary voltage drops up to 50% of rated voltage
- Push-to-test button is a standard feature to check contact operation

Catalog Number Selection

General Purpose Plug-In Relays—D9 Series

D9 Series ①

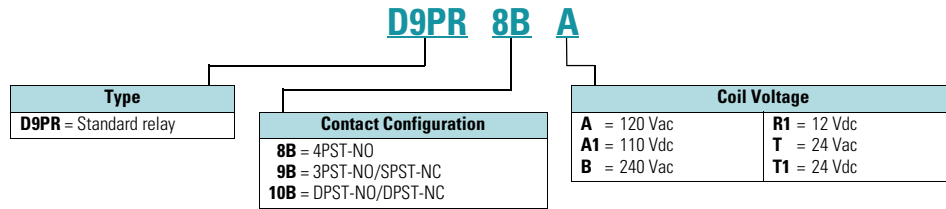

Product Selection

D9 Series

Coil Voltage	Catalog Number
4PST-NO Power Relay	
24 Vac	D9PR8BT
120 Vac	D9PR8BA
240 Vac	D9PR8BB
24 Vdc	D9PR8BT1
3PST-NO/SPST-NC Power Relay	
120 Vac	D9PR9BA
DPST-NO/DPST-NC Power Relay	
24 Vac	D9PR10BT
120 Vac	D9PR10BA
24 Vdc	D9PR10BT1

Note

- ① For deciphering catalog numbers.
Do not use for ordering as not all combinations are readily available.

General Purpose Type AA Relays



Features

- Type AA panel mounted relays are rated (each pole) 40A up to 300 Vac, 50/60 Hz; 5A at 480/600 Vac, 50/60 Hz and 40A at 28 Vdc
- 9575H Series 3000 relays are ideal for applications when controlling smaller loads such as single-phase motors

Catalog Number Selection

General Purpose Type AA Relays

Type AA

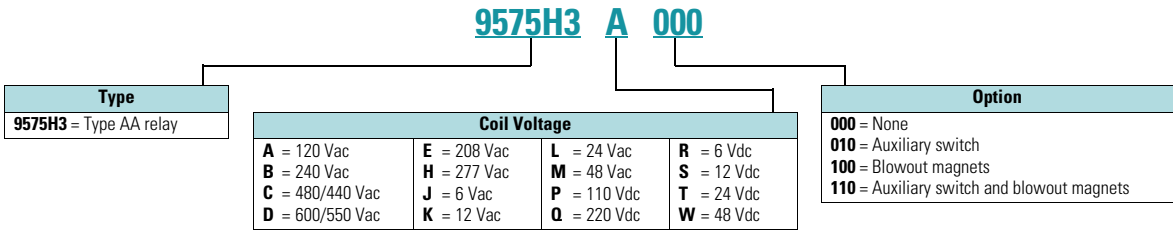

Product Selection

Type AA Relays

Relay Style	Catalog Number ^①
Relay (DPDT)	9575H3_000
Relay with auxiliary switch	9575H3_010
Relay with blowout magnets	9575H3_100
Relay with auxiliary switch and blowout magnets	9575H3_110

Coil Voltage Selection Table

Coil Voltage	Hz	Suffix Code
Volts AC		
120	50/60	A
240	50/60	B
480/440	60/50	C
600/550	60/50	D
208	50/60	E
277	50/60	H
6	50/60	J
12	50/60	K
24	50/60	L
48	50/60	M

Coil Voltage	Hz	Suffix Code
Volts DC		
110	—	P
220	—	Q
6	—	R
12	—	S
24	—	T
48	—	W

Note

① Underscore (_) indicates missing coil voltage suffix code. See table above.

XTRE Control Relays



Features

- 16A conventional thermal current (open at 60°C I_{th})
- Four-pole configurations
 - 4NO
 - 3NO-1NC
 - 2NO-2NC
- Expandable to eight-pole with add-on front-mount auxiliary contacts
- Built-in surge suppression on DC coils

Catalog Number Selection

XTRE Control Relays

XTRE Relays

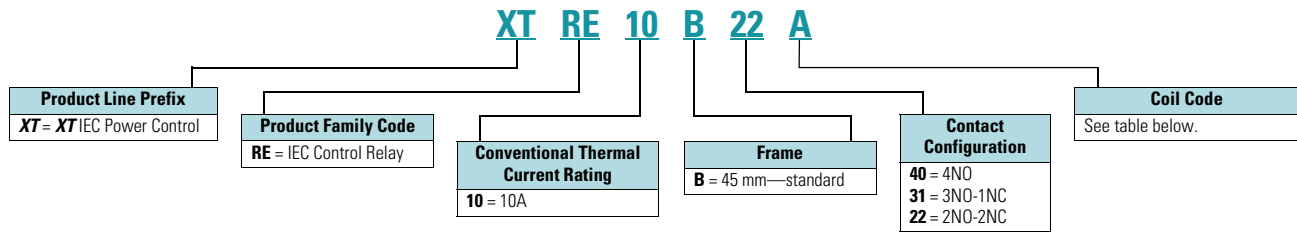

Product Selection

XTRE Control Relays

Conventional Thermal Current I_{th} (A), Open at 60°C	Contact Configuration	Rated Operational Current AC-15 I_o (A)			Circuit Symbol	Catalog Number—Screw Terminals ①
		220–240V	380–414V	500V		
16	4NO	6	4	1.5		XTRE10B40_
16	3NO-1NC	6	4	1.5		XTRE10B31_
16	2NO-2NC	6	4	1.5		XTRE10B22_ ②





Coil Voltage Suffix

Coil Voltage	Suffix Code	Coil Voltage	Suffix Code	Coil Voltage	Suffix Code
110V 50 Hz, 120V 60 Hz	A	24 Vdc	TD	550V 50 Hz, 600V 60 Hz	D
220V 50 Hz, 240V 60 Hz	B	415V 50 Hz, 480V 60 Hz	C	208V 60 Hz	E
24V 50/60 Hz	T				

Notes

- ① Underscore (_) indicates magnet coil suffix required. See table above.
- ② DC operated control relays XTRE(C)10B22_ can only be combined with two-pole auxiliary contacts.

Front Mount Auxiliary Contacts for Use with XTRE Control Relays ①

Conventional Thermal Current I _{th} (A), Open at 60°C	Poles	Rated Operational Current AC-15 I _e (A)			Contact Configuration	Circuit Symbol	Package Quantity	Catalog Number—Screw Terminals
		220V 230V 240V	380V 400V 415V	500V				
16	2	6	3	1.5	2NO		5	XTCEXFAC20v
16	2	6	3	1.5	1NC-1NC		5	XTCEXFAC11
16	4	6	3	1.5	4NO		5	XTCEXFAC40
16	4	6	3	1.5	2NO-2NC		5	XTCEXFAC22

Note

① Interlocked opposing contacts, to IEC/EN 60947-5-1 Annex L (positively driven), within the auxiliary contact modules (not NOE and NCL contacts) and between the auxiliary contacts and built-in contacts of the XTRE control relays.

Solid-State Relays—D93 Series



Features

- All solid-state circuitry with no moving parts to wear
- Compact, panel mounting for flexible installation
- Isolated input and output terminals to protect the system from electrical noise
- Internal snubber circuitry to protect the SSR from transients
- UL®/cUL® listed—UL 508
- CSA® certified
- CE marked
- RoHS compliant

Catalog Number Selection

Solid-State Relays—D93 Series

D93 Series

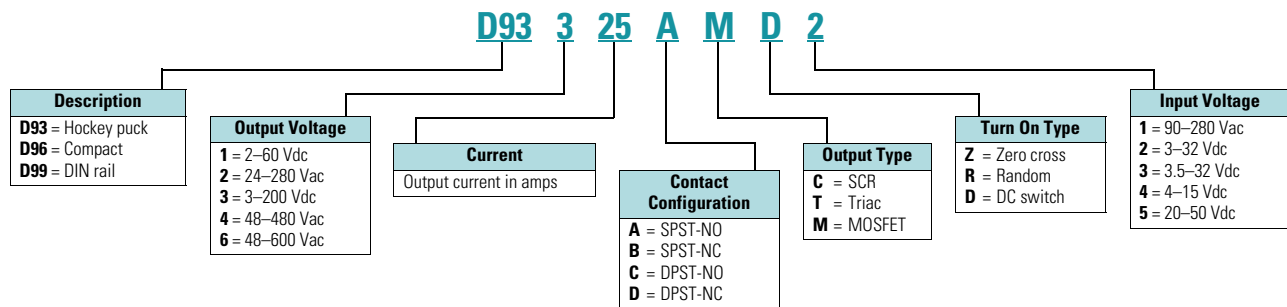

Product Selection

D93 Series

Input Voltage	Output Voltage	Contact Configuration	Switching Type	Rated Current Load (A)	Catalog Number
90–280 Vac	24–280 Vac	SPST-NO	Zero cross	10	D93210ACZ1
3–32 Vdc	24–280 Vac	SPST-NO	Zero cross	10	D93210ACZ2
3–32 Vdc	24–280 Vac	SPST-NO	Triac	10	D93210ATZ2
90–280 Vac	24–280 Vac	SPST-NO	Zero cross	25	D93225ACZ1
3–32 Vdc	24–280 Vac	SPST-NO	Zero cross	25	D93225ACZ2
3–32 Vdc	24–280 Vac	SPST-NO	Triac	25	D93225ATZ2
90–280 Vac	24–280 Vac	SPST-NO	Zero cross	40	D93240ACZ1
3–32 Vdc	24–280 Vac	SPST-NO	Zero cross	40	D93240ACZ2
3–32 Vdc	24–280 Vac	SPST-NO	Triac	40	D93240ATZ2
90–280 Vac	24–280 Vac	SPST-NO	Zero cross	50	D93250ACZ1
3–32 Vdc	24–280 Vac	SPST-NO	Zero cross	50	D93250ACZ2
90–280 Vac	24–280 Vac	SPST-NO	Zero cross	75	D93275ACZ1
3–32 Vdc	24–280 Vac	SPST-NO	Zero cross	75	D93275ACZ2
3–32 Vdc	3–200 Vdc	SPST-NO	MOSFET	12	D93312AMD2
3–32 Vdc	3–200 Vdc	SPST-NO	MOSFET	25	D93325AMD2
3–32 Vdc	3–200 Vdc	SPST-NO	MOSFET	40	D93340AMD2

Accessory

Heat Sink Accessory

Description	Catalog Number
Heat sink	D93HS1

Solid-State Relays—D96 Series



Features

- All solid-state circuitry has no moving parts to wear
- Integral heat sink eliminates the need for added accessories and installation
- Flexible mounting allows DIN rail or panel mounting without additional hardware or tools
- Isolated input and output terminals protect the system from electrical noise
- Internal snubber circuitry protects the SSR from transients
- UL/cUL listed—UL 508
- CSA certified
- CE marked
- RoHS compliant

Product Selection

Solid-State Relays—D96 Series

D96 Series

Input Voltage	Output Voltage	Contact Configuration	Switching Type	Rated Current Load (A)	Catalog Number
3.5–32 Vdc	3–50 Vdc	SPST-NO	DC switch	15	D96115ACZ3
3.5–32 Vdc	3–150 Vac	SPST-NO	DC switch	8	D96208ACZ3
90–280 Vac	24–280 Vac	SPST-NO	Random	10	D96210ACR1
3–32 Vdc	24–280 Vac	SPST-NO	Random	10	D96210ACR2
90–280 Vac	24–280 Vac	SPST-NO	Zero cross	10	D96210ACZ1
3–32 Vdc	24–280 Vac	SPST-NO	Zero cross	10	D96210ACZ2
3–32 Vdc	24–280 Vac	SPST-NC	Random	10	D96210BCR2
90–280 Vac	48–480 Vac	SPST-NO	Random	10	D96410ACR1
3–32 Vdc	48–480 Vac	SPST-NO	Random	10	D96410ACR2
90–280 Vac	48–480 Vac	SPST-NO	Zero cross	10	D96410ACZ1
3–32 Vdc	48–480 Vac	SPST-NO	Zero cross	10	D96410ACZ2
90–280 Vac	48–600 Vac	SPST-NO	Random	10	D96610ACR1
90–280 Vac	48–600 Vac	SPST-NO	Zero cross	10	D96610ACZ1
3–32 Vdc	48–600 Vac	SPST-NO	Zero cross	10	D96610ACZ2

Solid-State Relays—D99 Series



Features

- All solid-state circuitry has no moving parts to wear
- Integral heat sink eliminates the need for added accessories and installation
- Flexible mounting allows DIN rail or panel mounting without additional hardware or tools
- Isolated input and output terminals protect the system from electrical noise
- Internal snubber circuitry protects the SSR from transients
- UL/cUL listed—UL 508
- CSA certified
- CE marked
- RoHS compliant

Product Selection

Solid-State Relays—D99 Series

D99 Series

Input Voltage	Output Voltage	Contact Configuration	Switching Type	Rated Current Load (A)	Catalog Number
90–280 Vac	24–280 Vac	SPST-NO	Zero cross	10	D99210ACZ1
3–32 Vdc	24–280 Vac	SPST-NO	Zero cross	10	D99210ACZ2
90–280 Vac	24–280 Vac	SPST-NO	Zero cross	25	D99225ACZ1
3–32 Vdc	24–280 Vac	SPST-NO	Zero cross	25	D99225ACZ2
90–280 Vac	24–280 Vac	SPST-NO	Zero cross	40	D99240ACZ1
3–32 Vdc	24–280 Vac	SPST-NO	Zero cross	40	D99240ACZ2
90–280 Vac	48–600 Vac	SPST-NO	Zero cross	10	D99610ACZ1
3–32 Vdc	48–600 Vac	SPST-NO	Zero cross	10	D99610ACZ2
90–280 Vac	48–600 Vac	SPST-NO	Zero cross	25	D99625ACZ1
3–32 Vdc	48–600 Vac	SPST-NO	Zero cross	25	D99625ACZ2
90–280 Vac	48–600 Vac	SPST-NO	Zero cross	40	D99640ACZ1
3–32 Vdc	48–600 Vac	SPST-NO	Zero cross	40	D99640ACZ2

Universal TR Series Timing Relays



Features

- Multiple user-selectable timing functions and timing ranges in a single unit reduce product variations and stock keeping units (SKUs)
- Universal input voltages from 12 or 24–240 Vac/Vdc eliminate the need to order and stock separate coil voltages
- Compact, DIN rail mountable case reduces panel size
- Advanced LED indication makes troubleshooting easy
- Staggered terminal locations allow access to lower-level terminals after wiring
- SPDT or DPDT contacts with 8A ratings
- cULus listed
- CE marked
- RoHS compliant
- IEC/EN 61812

Product Selection

Universal TR Series Timing Relays

Universal TR Series

Supply Voltage	Description	Catalog Number
4-Function		
24–240 Vac/Vdc	Compact DIN rail mount, SPDT	TRL04
7-Function		
24–240 Vac/Vdc	Compact DIN rail mount, SPDT	TRL07
12–240 Vac/Vdc	Compact DIN rail mount, DPDT	TRL27
	Asymmetrical pulse generator, DPDT	TRW27

TMR5 Series Timing Relays



Features

- Single timing range for each unit
- Ranges available from 0.02 sec. to 24 hours
- Wide variety of functions available
- 10A DPDT output contacts

Catalog Number Selection

TMR5 Series Timing Relays

TMR5 Series

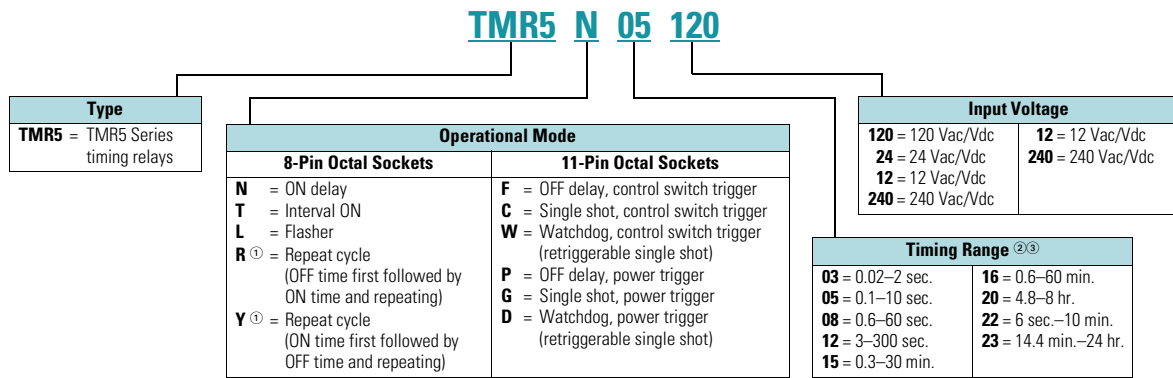

Product Selection

TMR5 Time Delay Relays

Input Voltage	Socket	Timing Range	Catalog Number
ON Delay			
120 Vac/Vdc	8-pin	0.1–10 sec.	TMR5N05120
120 Vac/Vdc		0.6–60 sec.	TMR5N08120
24 Vac/Vdc		0.1–10 sec.	TMR5N0524
24 Vac/Vdc		0.6–60 sec.	TMR5N0824
OFF Delay, Control Switch Trigger			
120 Vac/Vdc	11-pin	0.1–10 sec.	TMR5F05120
120 Vac/Vdc		0.6–60 sec.	TMR5F08120
24 Vac/Vdc		0.1–10 sec.	TMR5F0524
24 Vac/Vdc		0.6–60 sec.	TMR5F0824
Interval ON			
120 Vac/Vdc	8-pin	0.1–10 sec.	TMR5T05120
120 Vac/Vdc		0.6–60 sec.	TMR5T08120
24 Vac/Vdc		0.1–10 sec.	TMR5T0524
24 Vac/Vdc		0.6–60 sec.	TMR5T0824

Input Voltage	Socket	Timing Range	Catalog Number
Single Shot, Control Switch Trigger			
120 Vac/Vdc	11-pin	0.1–10 sec.	TMR5C05120
120 Vac/Vdc		0.6–60 sec.	TMR5C08120
24 Vac/Vdc		0.1–10 sec.	TMR5C0524
24 Vac/Vdc		0.6–60 sec.	TMR5C0824
Repeat Cycle (OFF Time First Followed by ON Time and Repeating)			
120 Vac/Vdc	8-pin	0.1–10 sec.	TMR5R05120
120 Vac/Vdc		0.6–60 sec.	TMR5R08120
24 Vac/Vdc		0.1–10 sec.	TMR5R0524
24 Vac/Vdc		0.6–60 sec.	TMR5R0824
Repeat Cycle (ON Time First Followed by OFF Time and Repeating)			
120 Vac/Vdc	8-pin	0.1–10 sec.	TMR5Y05120
120 Vac/Vdc		0.6–60 sec.	TMR5Y08120
24 Vac/Vdc		0.1–10 sec.	TMR5Y0524
24 Vac/Vdc		0.6–60 sec.	TMR5Y0824

Notes

- ① Indicates DUAL knob unit. All dual knob units can have independently selectable and adjustable ON and OFF times. If different ON and OFF times are desired, add two codes for time ranges in the part number. The first code listed indicates the first timing range of the unit (OFF time for R, ON time for Y) and the second code indicates the second timing range (ON time for R, OFF Time for Y).
- ② Any time range can be created as a custom unit. Contact Eaton for details.
- ③ Fixed time delay settings are available for orders of 50 pieces or more.

TMR6 Series Timing Relays



Features

- Provides OFF delay function without requiring input voltage during OFF time delay
- Duplicates operation of pneumatic OFF delay timers
- Each unit has eight timing ranges built in, covering 0.05 seconds to 30 minutes
- Selecting a range is easy using a rotary switch (no math is required or DIP switches to set)
- Uses industry-standard
- 8-pin octal socket
- 10A DPDT output contacts
- cRUus
- UL listed (with Eaton socket)
- RoHS compliant
- CE marked

Catalog Number Selection

TMR6 Series Timing Relays

TMR6 Series

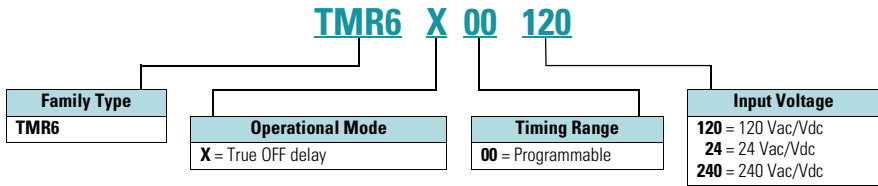

Product Selection

TMR6 True OFF Delay Relays

Input Voltage	Timing Range	Catalog Number
120 Vac/Vdc	0.05 sec.–30 min. (user selectable, eight ranges)	TMR6X00120
24 Vac/Vdc		TMR6X0024
240 Vac/Vdc		TMR6X00240

Accessories

Accessories for Use with TMR6 Time Delay Relays

Description	Standard Pack	Catalog Number
8-pin socket	10	D3PA2
Hold-down spring	10	D65CHDS

True OFF Delay

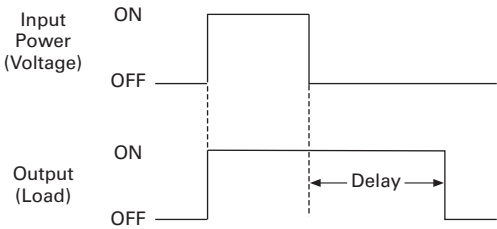

TMRP Series Timing Relays**Features**

- Multiple user-selectable timing functions and timing ranges in a single unit reduce product variations and stock keeping units (SKUs)
- Universal input voltages from 12–240 Vac/Vdc eliminate the need to order and stock separate coil voltages
- Timing ranges up to 9990 hours
- Dual LED indication makes troubleshooting easy
- Flexible design for back-panel, through-panel (45 mm x 45 mm cutout), or DIN rail mounting
- SPDT or DPDT contacts with 12A ratings
- Plastic dust cover keeps out contaminants and eliminates accidental set point changes
- Use with standard Eaton D3 sockets
- UL recognized
- CE marked
- RoHS compliant

Product Selection**TMRP Series Timing Relays****TMRP Timing Relays**

Supply Voltage	Description	Catalog Number
10-Function		
12–240 Vac/Vdc	Control switch trigger, DPDT	TMRP5100
	Control switch trigger, SPDT	TMRP5101
	Power trigger, DPDT	TMRP5102

Product Overview

Programmable Controllers Selection Guide



Description	Fusion Integrated Machine Controllers Page V9-T3-36	easy Programmable Relays Page V9-T3-37	MFD-Titan Multi-Functional Displays Page V9-T3-40	ELC Series PLCs Page V9-T3-46
User Interface				
LCD display (text/graphics)	3-, 4- or 5-line text (embedded)	4-line text (embedded)	4-line text and graphics (embedded)	Text and graphics thru HMI/ or ELC-GP (external)
Seven-segment display	—	—	4 characters (simulated)	PA only = 2 digital
Keypad for programming	Yes	Optional	Optional	—
Hand-held programmer	—	—	—	Available for all
Potentiometers	Simulated using display	Simulated using optional display	Simulated using optional display	PC/PH = two embedded
I/O Digital				
Embedded digital input types	3.5–30 Vdc	12 Vdc/24 Vdc 24 Vac or 110/240 Vac	24 Vac or 110/240 Vac (using MFD I/O)	24 Vdc or 110/240 Vac
Embedded digital output types	24 Vdc transistor or high current relay (5A resistive)	24 Vdc transistor or high current relay (8A resistive)	24 Vdc transistor or high current relay (8A resistive) (using MFD I/O)	24 Vdc transistor or relay
Embedded digital inputs/outputs per unit	10 control inputs 3 counter inputs/ 2 transistors 5 relays	easy500 = 8/4 easy700/800 = 12 (6 or 8)	12/4 (using MFD I/O)	PA = 4/2 PB = 8/6 PC/PH = 8/4 PV = 16/12
Expansion digital input types	—	24 Vdc or 110/240 Vac	24 Vdc or 110/240 Vac	24 Vdc or 110/240 Vac
Expansion digital output types	—	24 Vdc transistor or high current relay (8A resistive)	24 Vdc transistor or high current relay (8A resistive)	24 Vdc transistor, relay or high current relay (6A resistive)
Max. digital I/O includes embedded and expansion	20	easy500 = 12 easy700/800 = 40 easy800 (link up to 8 expanded units using easyNet) = 320	(link up to 8 expanded units with easyNet) = 320	PA/PB/PC/PH = 112 in/112 out and embedded PV = 240 in/240 out embedded
I/O Analog				
Embedded analog input quantity and types	2 at 4–20 mA 2 at 0–10 Vdc	Optional on 24 Vac or DC input units easy500 = 2 easy700 = 4 easy819/821 = N/A easy820/822 = 1 All 0 to +10 Vdc	Optional on 24 Vac or Vdc input units = 4 All 0 to +10 Vdc	PA = 2 at either –10 to +10 Vdc or –20 to +20 mA
Embedded analog input resolution	6.5 bit	10 bit	10 bit	12 bit
Embedded analog outputs quantity and types	1 at 4–20 mA 1 at 0–10 Vdc	Optional easy820/822 = 1 All 0 to +10 Vdc	Available using MFD-RA17 or MFD-TA17 MFD I/O Modules = 1 All 0 to +10 Vdc	PA = 2 at either –10 to +10 Vdc or –20 to +20 mA
Embedded analog output resolution	6.5 bit	10 bit	10 bit	12 bit
Expansion analog input types	—	0	0	–10 to +10 Vdc or –20 to +20 mA
Expansion analog input resolution	—	—	—	V = 12 bits, I = 11 or 13 bits ^①
Expansion analog outputs types	—	0	0	0 to 20 mA, 4 to 20 mA 0 to 10 Vdc, 2 to 10 Vdc ^①

Note

① Combo modules have 11 bit resolution; analog input-only modules support 13 bit.

For our complete product offering, see Volume 7—Logic Control, Operator Interface and Connectivity Solutions, CA08100008E and PG05400001E.

Programmable Controllers Selection Guide, continued



Fusion Integrated Machine Controllers



easy Programmable Relays



MFD-Titan Multi-Functional Displays



ELC Series PLCs

Description	Fusion Integrated Machine Controllers	easy Programmable Relays	MFD-Titan Multi-Functional Displays	ELC Series PLCs
I/O Analog				
Expansion analog output resolution	—	—	—	Voltage = 14 bit Current = 11 or 12 bit ①
Max. expansion analog inputs/outputs	—	0/0	0/0	Up to 32/up to 32 (max. using eight combo modules = 32 in + 16 out)
I/O Specialty Inputs				
RTD PT100	—	—	—	Four point expansion module
Thermocouple	—	—	—	Four point expansion module
Programming				
Programming tools	Software or front panel	Software; on-board keypad; memory module transfer	Software; on-board keypad; memory module transfer	Software; memory module transfer; hand-held programmer
Program size	100 rungs with up to 6 contacts and 1 coil per rung	easy500/700 = 128 rungs easy800 = 256 rungs	MFD = 256 rungs	PB = 4k steps PA/PC/PH = 8k steps PV = 16k steps
Programming languages	Ladder	Ladder; function block	Ladder; function block	Instructions, ladder, sequential function chart
Timers	8	easy500/700 = 16 easy800 = 32	32	PB = 128 PA/PC/PH/PV = 244 standard with additional timers for subroutine and retentive applications
General counters	8	easy500/700 = 16 easy800 = 32	32	PB = 128 PA/PC/PH = 235 PV = 253
High speed counters Quantity at max. speed (pulse train output use may limit maximum counter frequency)	Up to 14 kHz with five presets and prewarn	1 kHz	3 kHz	PB = up to 4, 2 at 20 kHz PA/PC = up to 6, 1 at 30 kHz and 1 at 10 kHz PH = up to 8, 1 at 100 kHz and 1 at 30 kHz PV = up to 8, 2 at 200 kHz 2 at 20 kHz; and 2 at 10 kHz
Pulse train outputs Quantity at max. speed (high speed input use may limit maximum speed for outputs)	—	—	—	PB = 2 at 10 kHz PA/PC = 1 at 30 kHz; and 1 at 10 kHz PH = 1 at 100 kHz; and 1 at 30 kHz PV = up to 2 at 200 kHz; and 1 at 40 kHz
Real time clock	Yes	easy500 = Optional easy700/800 = Yes	Yes	PA/PC/PH/PV = Yes Not available on PB

Note

① Combo modules have 11 bit resolution; analog input-only modules support 13 bit.

For our complete product offering, see Volume 7—Logic Control, Operator Interface and Connectivity Solutions, CA08100008E and PG05400001E.

Programmable Controllers Selection Guide, continued



Fusion Integrated Machine Controllers



easy Programmable Relays



MFD-Titan Multi-Functional Displays



ELC Series PLCs

Description	Fusion Integrated Machine Controllers	easy Programmable Relays	MFD-Titan Multi-Functional Displays	ELC Series PLCs
Communications				
Ports	1 RS-232/RS-485	Programming only	Programming only	1 RS-232 device or programming 1 RS-485 master or device
DeviceNet	—	easy700/800 = device only	Device only	PA/PB/PC/PH = device only PV = master and device
Ethernet OPC	—	easy700/800 = device only	Device only	PA/PB/PC/PH = device only PV = limited master and device
ASi	—	easy700/800 = device only	Device only	—
PROFIBUS-DP	—	easy700/800 = device only	Device only	—
CANopen	—	easy700/800 = device only	Device only	—
Modbus Serial	Device only	—	—	ASCII/RTU master and device
General Specifications				
CSA Hazardous location Class I, Division 2	—	Yes	—	—
Agency certifications	UL/cUL/CE	UL/CSA/CE/C-Tick	UL/CSA/CE/C-Tick	cULus/CE/C-Tick
Operating temperature range	0° to 50°C (32° to 122°F)	-25° to 55°C (-13° to 131°F)	-25° to 55°C (-13° to 131°F) Display -5° to 50°C	0° to 55°C (32° to 131°F)
Storage/transport temperature range	-20° to 70°C (-4° to 158°F)	-40° to 70°C (-40° to 158°F)	-40° to 70°C (-40° to 158°F)	-25° to 70°C (-13° to 158°F)
Nominal operating power	100/240 Vac 24 Vdc 12 Vdc	100/240 Vac 24 Vdc 12 Vdc	100/240 Vac 24 Vdc	24 Vdc 110/240 Vac using ELC power supply

For our complete product offering, see Volume 7—Logic Control, Operator Interface and Connectivity Solutions, CA08100008E and PG05400001E.

Fusion® Integrated Machine Controller**Features**

- User-configurable operator interface with back-lit LCD display and 18-button tactile feedback keypad
- High-speed counter with five presets and prewarn, totalizer, batch counter and ratemeter
- 10 parameter sets
- 13 digital inputs
- (2) 4–20 mA inputs
- (2) 0–10V input
- (3) Form C, 2 Form A, 2 NPN transistor, (1) 4–20 mA, and (1) 0–10V output
- RS-232 and RS-485 serial communications
- 100-line ladder logic processor for ultimate flexibility
- Configuration software included
- Type 4X enclosure

Product Selection**Fusion Integrated Machine Controller****Fusion Integrated Machine Controller**

Description	Catalog Number
Fusion integrated machine controller—10–30 Vdc power	57550400
Fusion integrated machine controller—85–265 Vac power	57551400

easy500/700/800 Programmable Relays



Features

- easy500 Series—for controlling small applications with up to 12 input/output signals
- easy700 Series—for controlling medium-sized applications with up to 40 input/output signals
- easy800 Series—for controlling large-scale applications with up to 320 input/output signals; use easyNet for applications beyond 40 I/O
- Available with or without 2.5 in LCD display
- DIN rail mounted or panel mounted using optional mounting feet

Catalog Number Selection

easy Programmable Relays

easy500/700/800

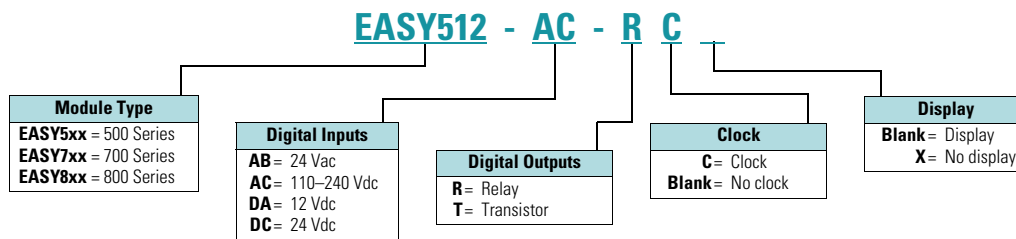

Note: Not all combinations are possible. See selection tables.

Product Selection

easy500—Display



easy500 Programmable Relays (Standalone)

Description	Inputs					Outputs		Catalog Number
	24 Vac	110–240 Vac	12 Vdc	24 Vdc	Analog ①	Relay	Transistor	
Display								
12 I/O, no clock	—	8	—	—	—	4	—	EASY512-AC-R
	—	—	—	8	2	4	—	EASY512-DC-R
12 I/O, clock	8	—	—	—	2	4	—	EASY512-AB-RC
	—	8	—	—	—	4	—	EASY512-AC-RC
	—	—	8	—	2	4	—	EASY512-DA-RC
	—	—	—	8	2	4	—	EASY512-DC-RC
	—	—	—	8	2	—	4	EASY512-DC-TC
No Display								
12 I/O, clock	8	—	—	—	2	4	—	EASY512-AB-RCX
	—	8	—	—	—	4	—	EASY512-AC-RCX
	—	—	8	—	2	4	—	EASY512-DA-RCX
	—	—	—	8	2	4	—	EASY512-DC-RCX
	—	—	—	8	2	—	4	EASY512-DC-TCX

easy500—No Display



easy700—Display



easy700 Programmable Relays (Expandable and Networkable)

Description	Inputs					Outputs		Catalog Number
	24 Vac	110–240 Vac	12 Vdc	24 Vdc	Analog ①	Relay	Transistor	
Display								
18 I/O, clock	12	—	—	—	4	6	—	EASY719-AB-RC
	—	12	—	—	—	6	—	EASY719-AC-RC
	—	—	12	—	4	6	—	EASY719-DA-RC
18 I/O, no clock	—	—	—	12	4	6	—	EASY719-DC-RC
	—	—	—	12	4	—	8	EASY721-DC-TC
No Display								
18 I/O, clock	12	—	—	—	4	6	—	EASY719-AB-RCX
	—	12	—	—	—	6	—	EASY719-AC-RCX
	—	—	12	—	4	6	—	EASY719-DA-RCX
18 I/O, no clock	—	—	—	12	4	6	—	EASY719-DC-RCX
	—	—	—	12	4	—	8	EASY721-DC-TCX

easy700—No Display



easy800—Display



easy800 Programmable Relays (Expandable and Networkable)

Description	Inputs			Outputs			Catalog Number
	110–240 Vac	24 Vdc	Analog ①	Relay	Transistor	Analog	
Display							
18 I/O, clock	12	—	—	6	—	—	EASY819-AC-RC
	—	12	4	6	—	—	EASY819-DC-RC
19 I/O, clock	—	12	4	6	—	1	EASY820-DC-RC
20 I/O, clock	—	12	4	—	8	—	EASY821-DC-TC
21 I/O, clock	—	12	4	—	8	1	EASY822-DC-TC
No Display							
18 I/O, clock	12	—	—	6	—	—	EASY819-AC-RCX
	—	12	4	6	—	—	EASY819-DC-RCX
19 I/O, clock	—	12	4	6	—	1	EASY820-DC-RCX
20 I/O, clock	—	12	4	—	8	—	EASY821-DC-TCX
21 I/O, clock	—	12	4	—	8	1	EASY822-DC-TCX

Note

① Analog inputs optional. Use of analog inputs will result in a decrease in the same number of available digital inputs.

EASY618_

Digital I/O Expansion Modules

Can be used via easyLink.



Supply Voltage	Digital Inputs	Outputs		Catalog Number
		Relay 10A (UL)	Transistor	
100–240 Vac	12	6	—	EASY618-AC-RE
24 Vdc	12	6	—	EASY618-DC-RE
24 Vdc	12	—	8	EASY620-DC-TE
24 Vdc	6	4	—	EASY410-DC-RE
24 Vdc	6	—	4	EASY410-DC-TE
24 Vdc	—	2	—	EASY202-RE
For distributed connection of a digital input/output expansion at up to 98 ft (30m) distance				EASY200-EASY

EASY406_

Analog I/O Expansion Modules

Can be used via easyLink.



Supply Voltage	Inputs		Digital Outputs		Analog Outputs	Catalog Number
	Digital/ Analog	Can Be Used for Digital	Relay 10A (UL)	Transistor		
24 Vdc	1/2	2	—	2	1	EASY406-DC-ME
24 Vdc	1/6	2	—	2	2	EASY411-DC-ME

EASY209-SE

Ethernet Gateway Module



Description	Catalog Number
Ethernet gateway Serial interface easyRelay or MFD-...CP8/CP10_ to Ethernet, for connecting to easyOPC server, easySoft or easyCom	EASY209-SE

EASY204-DP

Network Interface Modules



Description	Catalog Number
DeviceNet interface module	Addresses available 0 to 63 EASY222-DN
PROFIBUS-DP interface module	Device addresses available 1 to 126 EASY204-DP
AS-Interface interface module with 4 in and 4 out	Device: 4 inputs, 4 outputs, 4 parameter bits Addresses available 0 to 31 EASY205-ASI
CANopen interface module	Addresses available 1 to 127 EASY221-CO

MFD-80-B



MFD-Titan Display/Operator Unit

Monochrome display 132 x 64 pixels with switchable backlight and removable front frame.

Description	Keypad	Eaton Logo	Catalog Number
MFD display, NEMA 4X indoor rated	—	—	MFD-80-X
MFD display, NEMA 4X indoor rated	—	■	MFD-80
MFD display/keypad, NEMA 4X in conjunction with MFD-XM-80 protective diaphragm	■	—	MFD-80-B-X
MFD display/keypad, NEMA 4X in conjunction with MFD-XM-80 protective diaphragm	■	■	MFD-80-B

MFD-CP4



MFD-Titan Text/Graphics Display Modules

Combine with MFD-80-_ to use as remote text/graphics display.

Supply Voltage	Description	Catalog Number
100–240 Vac	AC power supply / communication module (no cable)	MFD-AC-CP4
	AC module for easy500/700 relays and cable MFD-CP4-500-CAB5	MFD-AC-CP4-500
	AC module for easy800 relays and cable MFD-CP4-800-CAB5	MFD-AC-CP4-800
24 Vdc	DC power supply / communication module (no cable)	MFD-CP4
	DC module for easy500/700 relays and cable MFD-CP4-500-CAB5	MFD-CP4-500
	DC module for easy800 relays and cable MFD-CP4-800-CAB5	MFD-CP4-800

MFD-CP



MFD-Titan Controller Module

Attach to MFD-80-_ display/operator unit and add MFD-Titan I/O modules as needed.

Supply Voltage	Description	Catalog Number
100–240 Vac	Program and screen memory	MFD-AC-CP8-ME
	Program and screen memory, with easyNet	MFD-AC-CP8-NT
24 Vdc	Program and screen memory	MFD-CP8-ME
	Program and screen memory, with easyNet	MFD-CP8-NT
	Double program and screen memory (as MFD-CP8)	MFD-CP10-ME
	Double program and screen memory (as MFD-CP8), with easyNet	MFD-CP10-NT

MFD-R16



MFD-Titan I/O Modules

Attach to back of MFD-Titan controller modules.

Supply Voltage	Description	Inputs ^①		Outputs			Catalog Number
		Digital	Analog	Relay	Transistor	Analog	
100–240 Vac	16 I/O	12	—	4	—	—	MFD-AC-R16
24 Vdc		12	4	4	—	—	MFD-R16
		12	4	—	4	—	MFD-T16
24 Vdc	17 I/O	12	4	4	—	1	MFD-RA17
		12	4	—	4	1	MFD-TA17

MFD-TP_



MFD-Titan I/O Modules with Temperature Detection

For use with MFD-CP8-_ from device version 08, MFD-CP10.

Supply Voltage	Inputs			Outputs			Temperature Ranges	Catalog Number
	Digital	Can Be Used For Analog	Pt100	Relay 10A (UL)	Transistor	Analog		
24 Vdc	6	2	2	—	4	—	–40° to +90°C/0° to +250°C/0° to +400°C	MFD-TP12-PT-A
	6	2	2	—	4	—	–200° to +200°C/0° to +850°C	MFD-TP12-PT-B
	6	2	—	—	4	—	–40° to +90°C/0° to +250°C	MFD-TP12-NI-A
	6	2	2	—	4	1	–40° to +90°C/0° to +250°C/0° to +400°C	MFD-TAP13-PT-A
	6	2	2	—	4	1	–200° to +200°C/0° to +850°C	MFD-TAP13-PT-B
	6	2	—	—	4	1	–40° to +90°C/0° to +250°C	MFD-TAP13-NI-A

Note

① Analog inputs optional.

easy802/806 Programmable Relays with SmartWire-DT



Features

- Combines the functions of an easy800 with direct connection to SmartWire-DT
- Exchange of data as well as power supply for the SmartWire-DT devices and contactors
- Up to 99 SmartWire-DT nodes in total with up to 166 inputs/ outputs that can be connected
- Up to eight easy806 controllers can be connected via easyNet
- easy806 controllers include four high-speed inputs, two of which can be outputs
- Serial interface for programming or connection of an MFD remote text display or XV touch panel

Product Selection

easy802/806 Programmable Relays with SmartWire-DT

Control relay for connection of SmartWire-DT and simultaneously for supply of power to the SmartWire-DT devices, such as switchgear and contactors.

EASY802-DC-SWD



easy800 with SmartWire-DT

Supply Voltage	Description	Catalog Number
24 Vdc	Control relay with SmartWire-DT	EASY802-DC-SWD

EASY806-DC-SWD



24 Vdc	Control relay with SmartWire-DT, four inputs, two of which can be used as outputs (transistor 24 Vdc, 0.1A), easyNet onboard	EASY806-DC-SWD
--------	--	-----------------------

XC152 PLC



Features

- CoDeSys PLC and Web visualization
- Galileo/CoDeSys remote visualization
- Ethernet port on all models
- Windows® CE 5 operating system
- 32-bit RISC CPU at 400 MHz
- 64 MB internal memory
- SD card slot for external memory
- Run/Stop switch
- Optional: Integrated SmartWire-DT master for 99 nodes
- Optional: RS-232, RS-485, PROFIBUS-DP/MPI, CANopen/easyNet

Catalog Number Selection

XC152 PLCs with and without SmartWire-DT

XC PLC

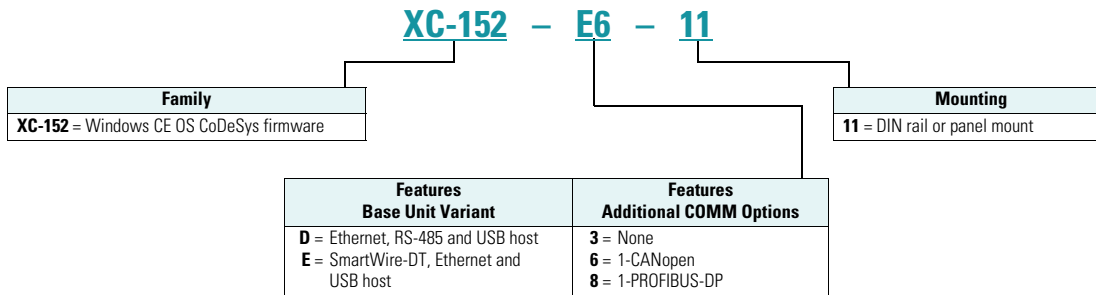

Product Selection

XC152 PLC



XC152 PLC

CoDeSys Firmware	Fieldbus Type	RS-232	RS-485	Ethernet	Catalog Number
Y	CANopen	Y	Y	Y	XC-152-D6-11
Y	PROFIBUS-DP	Y	Y	Y	XC-152-D8-11

XC152 PLC SmartWire-DT



XC152 PLC SmartWire-DT

CoDeSys Firmware	Fieldbus Type	RS-232	RS-485	Ethernet	SmartWire-DT	Catalog Number
Y	None	Y	None	Y	Y	XC-152-E3-11
Y	CANopen	None	Y	Y	Y	XC-152-E6-11
Y	PROFIBUS-DP	None	Y	Y	Y	XC-152-E8-11

Accessories

XC PLC Accessories

Description	Catalog Number
PLC programming software, single seat license	SW-XSOFT-CODESYS-2-S ①
PLC programming software, multiple seat license	SW-XSOFT-CODESYS-2-M ①
SD memory card	MEMORY-SD-A1-S

Note

① For details on SW-XSoft-CoDeSys software, see Volume 7—Logic Control, Operator Interface and Connectivity Solutions, CA08100008E, Tab 4.

XV Series HMI-PLC

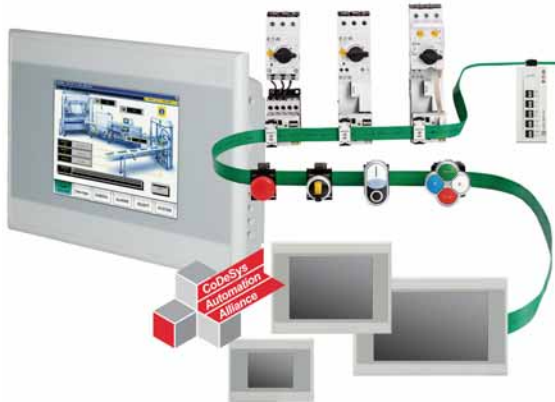

Features

- High resolution resistive touch TFT displays
- Brilliant image display with 65,536 colors
- 3.5 in, 5.7 in or 7 in widescreen displays in robust plastic housings and bezels, or 5.7 in, 8.4 in or 10.4 in displays in high-end aluminum front bezels and metal housings
- Ethernet and RS-485 serial ports on all models
- PROFIBUS-DP or CANopen master on all models larger than 3.5 inches
- Programmable with IEC 61131-3 compliant XSoft-CoDeSys software
- Built-in SmartWire-DT master for 99 nodes
- Easy connection direct to motor control components or I/O modules on the SmartWire-DT flat cable
- Web/remote visualization
- RISC CPU 32-bit 400 MHz
- 64 MB memory
- SD card slot

Catalog Number Selection

XV Series HMI-PLCs with and without SmartWire-DT

XV HMI-PLC

XV - 102 - E6 - 35TQRG - 10

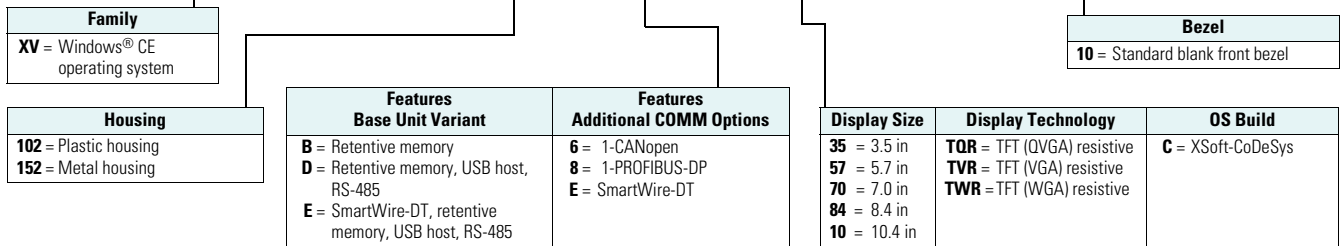

Product Selection

XV HMI-PLC



XV HMI-PLC

Display Size/Type	Display Resolution	CoDeSys Firmware	Fieldbus Type	RS-485	Ethernet	Catalog Number
Plastic Housing						
3.5 in TFT Resistive	QVGA 320x240	Y	CANopen	Y	Y	XV-102-B6-35TQRC-10
		Y	PROFIBUS-DP	Y	Y	XV-102-B8-35TQRC-10
5.7 in TFT Resistive	VGA 640x480	Y	CANopen	Y	Y	XV-102-D6-57TVRC-10
		Y	PROFIBUS-DP	Y	Y	XV-102-D8-57TVRC-10
7.0 in TFT Resistive	WGA 800x480	Y	CANopen	Y	Y	XV-102-D6-70TWRC-10
		Y	PROFIBUS-DP	Y	Y	XV-102-D8-70TWRC-10
Metal Housing						
5.7 in TFT Resistive	VGA 640x480	Y	CANopen	Y	Y	XV-152-D6-57TVRC-10
		Y	PROFIBUS-DP	Y	Y	XV-152-D8-57TVRC-10
8.4 in TFT Resistive	VGA 640x480	Y	CANopen	Y	Y	XV-152-D6-84TVRC-10
		Y	PROFIBUS-DP	Y	Y	XV-152-D8-84TVRC-10
10.4 in TFT Resistive	VGA 640x480	Y	CANopen	Y	Y	XV-152-D6-10TVRC-10
		Y	PROFIBUS-DP	Y	Y	XV-152-D8-10TVRC-10

XV HMI-PLC with SmartWire-DT



XV HMI-PLC SmartWire-DT

Display Size/Type	Display Resolution	CoDeSys Firmware	Fieldbus Type	RS-485	Ethernet	SmartWire-DT	Catalog Number
Plastic Housing							
3.5 in TFT	QVGA 320x240	Y	None	None	Y	Y	XV-102-BE-35TQRC-10
5.7 in TFT	VGA 640x480	Y	CANopen	Y	Y	Y	XV-102-E6-57TVRC-10
		Y	PROFIBUS-DP	Y	Y	Y	XV-102-E8-57TVRC-10
7.0 in TFT	WGA 800x480	Y	CANopen	Y	Y	Y	XV-102-E6-70TWRC-10
		Y	PROFIBUS-DP	Y	Y	Y	XV-102-E8-70TWRC-10
Metal Housing							
5.7 in TFT	VGA 640x480	Y	CANopen	Y	Y	Y	XV-152-E6-57TVRC-10
		Y	PROFIBUS-DP	Y	Y	Y	XV-152-E8-57TVRC-10
8.4 in TFT	VGA 640x480	Y	CANopen	Y	Y	Y	XV-152-E6-84TVRC-10
		Y	PROFIBUS-DP	Y	Y	Y	XV-152-E8-84TVRC-10
10.4 in TFT	VGA 640x480	Y	CANopen	Y	Y	Y	XV-152-E6-10TVRC-10
		Y	PROFIBUS-DP	Y	Y	Y	XV-152-E8-10TVRC-10

Accessories

XV HMI-PLC Accessories

Description	Catalog Number
HMI-PLC programming software, single seat license	SW-XSOFT-CODESYS-2-S ①
HMI-PLC programming software, multiple seat license	SW-XSOFT-CODESYS-2-M ①
SD memory card	MEMORY-SD-A1-S
XV-102 parts kit (1 power conductor, 8 mounting brackets, 1 sealing strip, 1 touch pen)	ACC-TP-57-KG-1
XV-152 parts kit (1 power conductor, 8 mounting brackets, 1 sealing strip, 1 touch pen)	ACC-TP-10-12-RES-1

Note

① For details on SW-XSoft-CoDeSys software, see Volume 7—Logic Control, Operator Interface and Connectivity Solutions, CA08100008E, Tab 4.

ELC Programmable Logic Controllers



Features

- Modular PLC logic platform with a range of basic to sophisticated CPUs
- Ethernet and DeviceNet master communications
- Distributed I/O for EtherNet/IP, Modbus TCP, PROFIBUS-DP, DeviceNet and Modbus serial networks

Catalog Number Selection

ELC Series Programmable Logic Controllers

Controllers and Expansion Modules

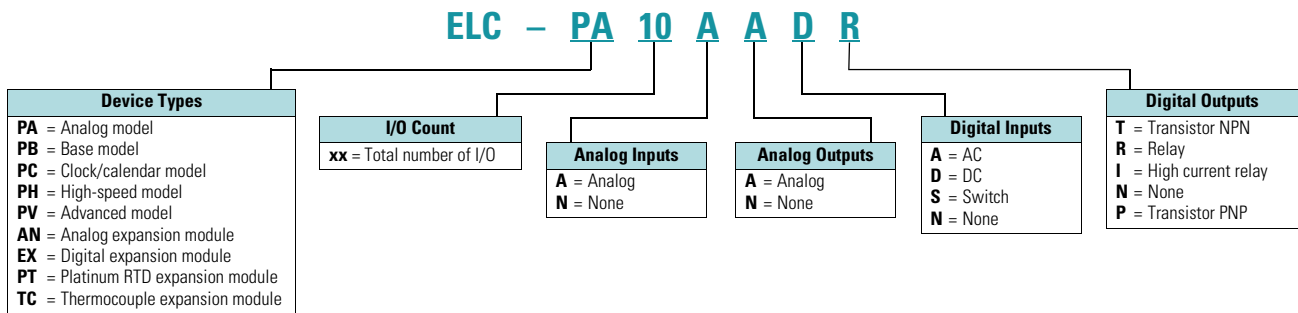

Master Communication Modules

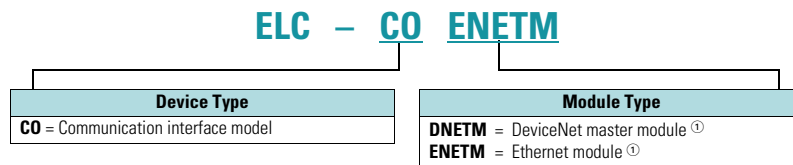

Distributed I/O Adapter Modules

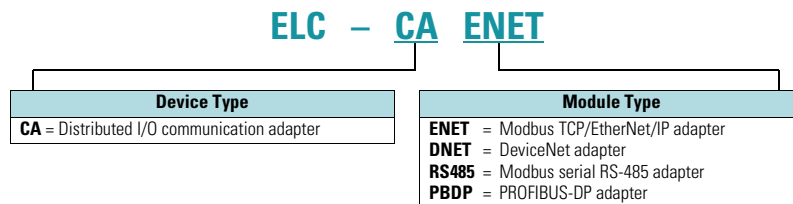

Note

^① Left side communications module.

Product Selection

Controllers

Description	Inputs	Outputs	Analog	High Speed I/O	Maximum Current Consumption (at 24 Vdc)	Catalog Number
ELC-PB Model and 14 I/O built-in	(8) 24 Vdc	(6) Relay, 1.5A	—	(2) 20 kHz inputs	150 mA	ELC-PB14NNDR
	(8) 24 Vdc	(6) Transistor, 100 mA	—	(2) 20 kHz inputs	150 mA	ELC-PB14NNDT
ELC-PC Model and 12 I/O built-in	(8) 24 Vdc	(4) Relay, 1.5A	—	(1) 30 kHz inputs	150 mA	ELC-PC12NNDR
	(8) 24 Vdc	(4) Transistor, 100 mA	—	(1) 30 kHz inputs	150 mA	ELC-PC12NNDT
	(8) 110 Vac	(4) Relay, 1.5A	—	(1) 30 kHz inputs	150 mA	ELC-PC12NNAR
ELC-PH Model and 12 I/O built-in	(8) 24 Vdc	(4) Transistor, 100 mA	—	(1) 100 kHz inputs	170 mA	ELC-PH12NNDT
ELC-PA Model and 10 I/O built-in	(4) 24 Vdc	(2) Relay, 1.5A	(2) In and (2) Out	(1) 30 kHz inputs	210 mA	ELC-PA10AADR
	(4) 24 Vdc	(2) Relay, 1.5A	(2) In and (2) Out	(1) 30 kHz inputs	210 mA	ELC-PA10AADT
ELC-PV Model and 28 I/O built-in	(16) 24 Vdc	(12) Relay, 1.5A	—	(2) 200 kHz inputs	220 mA	ELC-PV28NNDR
	(16) 24 Vdc	(12) Transistor, 100 mA	—	(2) 200 kHz inputs	220 mA	ELC-PV28NNDT

Distributed I/O Adapter Modules

Description	Catalog Number
Modbus TCP/EtherNet/IP I/O adapter	ELC-CAENET
Modbus serial RS-485 I/O adapter	ELC-CARS485
DeviceNet I/O adapter	ELC-CADNET
PROFIBUS-DP I/O adapter	ELC-CAPBDP

Network Communication Master Modules (Left Side Bus)

Description	Catalog Number
Ethernet Modbus TCP (master/node)	ELC-COENETM
DeviceNet scanner (master/node)	ELC-CODNETM

Digital Expansion Modules (Right Side Bus)

Description	Inputs	Outputs	Maximum Current Consumption (at 24 Vdc)	Catalog Number
8 DC input module	(8) 24 Vdc	—	50 mA	ELC-EX08NNDN
16 DC input module	(16) 24 Vdc	—	100 mA	ELC-EX16NNDN
8 DC input/output module	(4) 24 Vdc	(4) Transistor (sink), 0.3A	70 mA	ELC-EX08NNDT
16 DC input/output module	(8) 24 Vdc	(8) Transistor (sink), 0.3A	90 mA	ELC-EX16NNDT
16 DC input/output module	(8) 24 Vdc	(8) Transistor (source), 0.3A	100 mA	ELC-EX16NNDP
8 DC input/relay output module	(4) 24 Vdc	(4) Relay, 1.5A	70 mA	ELC-EX08NNDR
16 DC input/relay output module	(8) 24 Vdc	(8) Relay, 1.5A	90 mA	ELC-EX16NNDR
8 AC input module	(8) 110 Vac	—	50 mA	ELC-EX08NNAN
8 Transistor output module	—	(8) Transistor (sink), 0.3A	70 mA	ELC-EX08NNNT
8 Relay output module	—	(8) Relay, 1.5A	70 mA	ELC-EX08NNNR
6 High current relay output module	—	(6) Relay, 6A	70 mA	ELC-EX06NNNI
8 Toggle switch input module	(8) Switches	—	20 mA	ELC-EX08NNSN

Analog and Temperature Expansion Modules (Right Side Bus)

Description	Analog Inputs	Analog Outputs	Maximum Current Consumption (at 24 Vdc)	Catalog Number
4 Analog input module	4	—	90 mA	ELC-AN04ANNN
2 Analog output module	—	2	125 mA	ELC-AN02NANN
4 Analog output module	—	4	170 mA	ELC-AN04NANN
6 Analog input/output module	4	2	90 mA	ELC-AN06AANN
4 Thermocouple input module (J, K, R, S and T)	4	—	90 mA	ELC-TC04ANNN
4 Platinum RTD input module (PT100)	4	—	90 mA	ELC-PT04ANNN

Specialty Expansion Modules (Right Side Bus)

Description	Catalog Number
Single axis motion control module (Add up to 8 modules per controller)	ELC-MC01
RS-485 Easy Connect adapter (DB9, RJ12, 2-pin connections to RS-485)	ELC-485APTR

Accessories and Software

Description	Catalog Number
ELC programming software	ELCSOFT
24 Vdc, 1A power supply	ELC-PS01
24 Vdc, 2A power supply	ELC-PS02
Cable to connect a PC or a GP unit to ELC, 1 meter (DB9 pin female to 8-pin DIN)	ELC-CBPCELC1
Cable to connect a PC or a GP unit to ELC, 3 meters (DB9 pin female to 8-pin DIN)	ELC-CBPCELC3
Cable to connect a PC to a GP unit, 3 meters (DB9 pin female to DB9 pin female)	ELC-CBPCEGP3
Program transfer module for ELC controllers	ELC-ACPGMXFR
Plate mount for specialty modules, qty. 10	ELC-ACCOVER

Product Overview

Preset Counters Selection Guide



Description	E5-148-C1400 Page V9-T3-50	E5-648-C Series Page V9-T3-50	Eclipse Series Page V9-T3-51
Display	Two-line LCD	Two-line LCD	LED
Power supply	Replaceable lithium batteries	10–30 Vdc or 90–260 Vac	9–30 Vdc or 85–265 Vac
Number of digits	6	6	6
Panel cut-out size	45 x 45 mm (1/16 DIN)	45 x 45 mm (1/16 DIN)	92 x 45 mm (1/8 DIN)
Scaling capability	—	Yes	Yes
Number of presets	1	2 or 4	2
Max. counting speed	25 Hz	10 kHz	Up to 8,250 Hz
Front panel protection	IP65	IP65	Type 4X
Other features/functions	—	Timer/rate indicator	Analog retransmission/RS-485 communications
Relay rating(s)	2A	3A	5A

For our complete product offering, see Volume 7—Logic Control, Operator Interface and Connectivity Solutions, CA08100008E and PG05400001E.

1/16 DIN LCD Preset Counter



Features

Battery powered

- Two-line LC displays count, preset and level of the output
- Replacement for electromechanical preset counters
- No power supply necessary (battery operated)
- Count and reset input electrically separated from counter through optocoupler input range 12–250 Vac/Vdc

AC/DC powered

- Two-line LCD with optional two-color display
- Programmable as impulse counter, frequency meter or time meter with sign and zero blanking
- Batch mode
- Add/subtract/ratio functions

Catalog Number Selection

1/16 DIN LCD Preset Counter

LCD Preset Counter

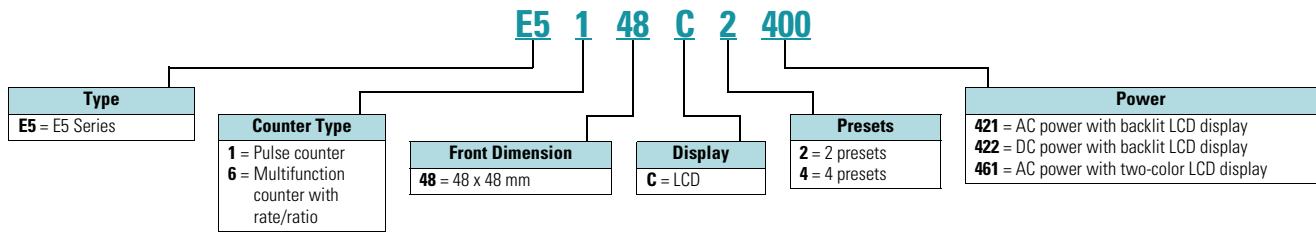

Product Selection

1/16 DIN LCD

Description	Catalog Number
Battery Powered 1 Preset LCD	
Battery power 1.89 x 1.89 in (48 x 48 mm)	E5-148-C1400
AC/DC Powered 2 Preset LCD	
90–260 Vac power 1.89 x 1.89 in (48 x 48 mm)	E5-648-C2421
10–30 Vdc power 1.89 x 1.89 in (48 x 48 mm)	E5-648-C2422
AC Powered 4 Preset Two-Color LCD	
90–260 Vac power 1.89 x 1.89 in (48 x 48 mm)	E5-648-C4461

1/18 DIN Eclipse Series Preset Counter



Features

- 1/8 DIN cutout
- Type 4X front panel protection
- Seven-segment LED display

Catalog Number Selection

1/18 DIN Eclipse Series Preset Counter

Eclipse Series Preset Counter

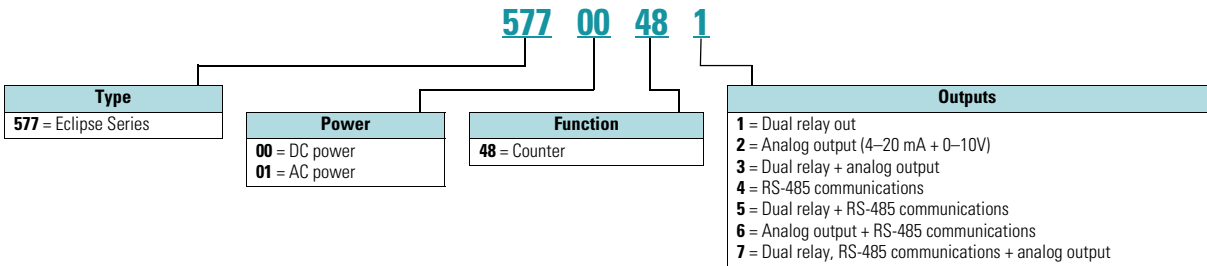

Product Selection

LED Count Control, 6-Digit

Description	Catalog Number
Relay out, 9–30 Vdc power	57700481
Relay out, 85–265 Vac power	57701481
Relay and analog out, 9–30 Vdc power	57700483
Relay and analog out, 85–265 Vac power	57701483
Relay and RS-485 out, 9–30 Vdc power	57700485
Relay and RS-485 out, 85–265 Vac power	57701485
Relay, analog and RS-485 out, 9–30 Vdc power	57700487
Relay, analog and RS-485 out, 85–265 Vac power	57701487

Product Overview

Ratemeters Selection Guide

3



Description	Courier Series	Eclipse Series
	Page V9-T3-53	Page V9-T3-54
Display	LCD	LED
Power supply	Replaceable lithium battery	9–30 Vdc or 85–265 Vac
Number of digits	5	6
Panel cut-out size	68 x 33 mm	92 x 45 mm (1/8 DIN)
Scaling capability	Yes	Yes
Number of presets	—	2 (with optional relay out model)
Update time	700 ms	500 ms
Front panel protection	Type 4X	Type 4X
Other features/functions	Optional backlight, optional extended temperature range	Analog retransmission/RS-485 communications
Relay rating(s)	—	5A

For our complete product offering, see Volume 7—Logic Control, Operator Interface and Connectivity Solutions, CA08100008E and PG05400001E.

Courier Series Battery Powered Ratemeter



Features

- 1/Tau ratemeter
- Scaling capabilities
- Type 4X protection
- Internal battery: 3V, lithium

Catalog Number Selection

Courier Series Battery Powered Ratemeter

Courier Series

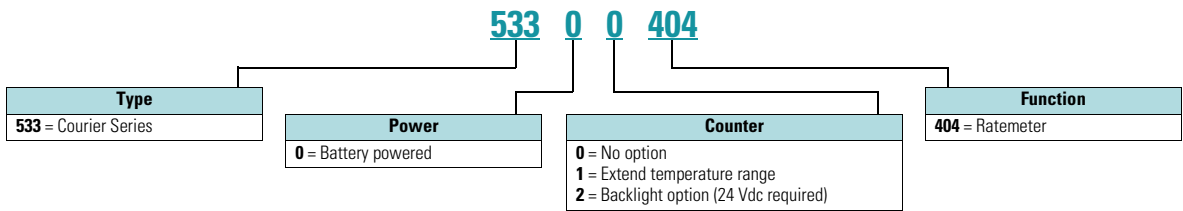

Product Selection

1/Tau LCD Ratemeter

Description	Catalog Number
Battery powered	53300404

Eclipse Series 1/8 DIN LED Ratemeter



Features

- 1/8 DIN cutout
- Type 4X front panel protection
- Front panel programming

Catalog Number Selection

Eclipse Series 1/8 DIN LED Ratemeter

Eclipse Series

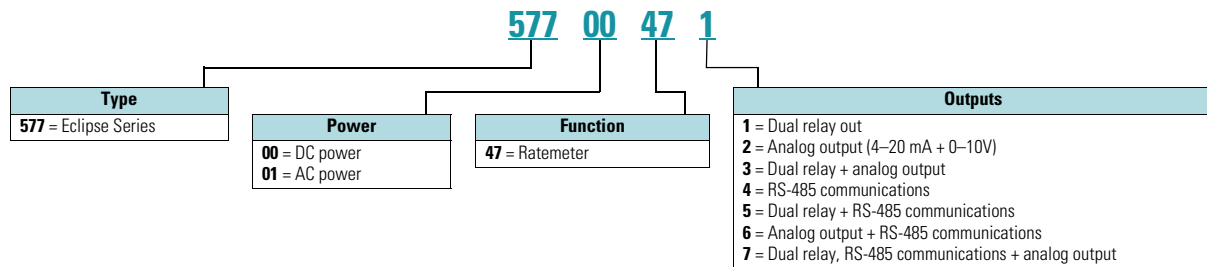

Product Selection

Eclipse Series 5-Digit LED Ratemeter

Description	Catalog Number
9–30 Vdc	57700470
9–30 Vdc, alarms	57700471
9–30 Vdc, analog out	57700472
9–30 Vdc, alarms, analog out	57700473
9–30 Vdc, RS-485	57700474
9–30 Vdc, alarms, RS-485	57700475
9–30 Vdc, analog out, RS-485	57700476
9–30 Vdc, alarms, analog out, RS-485	57700477
85–265 Vac	57701470
85–265 Vac, alarms	57701471
85–265 Vac, analog out	57701472
85–265 Vac, alarms, analog out	57701473
85–265 Vac, RS-485	57701474
85–265 Vac, alarms, RS-485	57701475
85–265 Vac, analog out, RS-485	57701476
85–265 Vac, alarms, analog out, RS-485	57701477

Product Overview

Hour Meters Selection Guide



Description	T48 Series Page V9-T3-56	6-T-3H Series Page V9-T3-56	E5-224 Series Page V9-T3-57	E42 Series Page V9-T3-57
Panel cut-out size	45 x 45 mm (1/16 DIN)	50.8 mm (2 in) round	22 x 45 mm (1/32 DIN)	52.3 mm (2.06 in) round OR 24 x 36.8 mm
Display type	Mechanical	Mechanical	LCD	LCD
Number of digits	7 for AC versions, 8 for DC versions	6	8	6
Power supply	10–30 Vdc or 100–130 Vac	115 Vac	Internal battery	12–60 Vdc or 48–230 Vac
Timing method	Synchronous motor	Quartz	Solid-state	Solid-state
Front panel protection	IP65	Type 4X	IP65	No protection ratings
Resolution	0.1 hour	0.1 hour	0.1 second	0.1 hour

For our complete product offering, see Volume 7—Logic Control, Operator Interface and Connectivity Solutions, CA08100008E and PG05400001E.

Electromechanical Hour Meters



Features

- 1/16 DIN
 - High shock-resistance
 - Without reset
 - Data retention if power is lost
- 71.1 mm round
- 6-digit hour meter for round panel cut-out
 - Low cost
 - Waterproof
 - Type 4X protection

Catalog Number Selection

Electromechanical Hour Meters

Hour Meters

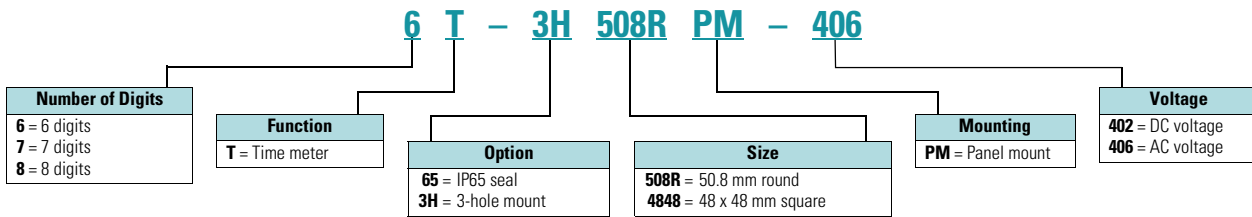

Product Selection

Electromechanical Hour Meters

Description	Catalog Number
1/16 DIN	
10–30 Vdc, 1.89 x 1.89 in (48 x 48 mm)	8-T-65-4848PM-402
100–130 Vac, 1.89 x 1.89 in (48 x 48 mm)	7-T-65-4848PM-406
71.1 mm Round	
115 Vac, 2.80 in (71.1 mm) round	6-T-3H-508RPM-406
10–80 Vdc, 2.80 in (71.1 mm) round	6-T-3H-508RPM-402

Accessories

DIN Rail Adapter



DIN Rail Adapter

Description	Catalog Number
DIN rail adapter for DIN electromechanical hour meter	T4848DINADAPT

Electronic LCD Hour Meters



Features

Battery powered

- Low price and high efficiency
- Large 8-digit LCD display, height of the figures 0.31 in (8 mm)
- Different time ranges from 0.1 second to 100,000 hours
- Lifetime of the battery is approximately eight years

AC/DC powered

- Solid-state hour meters
- Record and display up to 99,999.9 hours, rollover and continue timing
- EEPROM memory can retain data for 25+ years
- Time accumulation indicated by flashing hourglass icon

Product Selection

Electronic LCD Hour Meters

LCD Hour Meters

Description	Catalog Number
Battery Powered 1/32 DIN 8-Digit LCD	
Hours/minutes, 0.94 x 1.89 in (24 x 48 mm)	E5-224-C0440
Hours/minutes, 10–260V input, 0.94 x 1.89 in (24 x 48 mm)	E5-224-C0448
Minutes/seconds, 0.94 x 1.89 in (24 x 48 mm)	E5-224-C0450
Minutes/seconds, 10–260V input 0.94 x 1.89 in (24 x 48 mm)	E5-224-C0458
AC/DC Powered Round LCD	
Elapsed hour meter, 48–150 Vdc/100–230 Vac	E42DIR48230
Elapsed hour meter w/reset, 48–150 Vdc/100–230 Vac	E42DIR48230R
Elapsed hour meter, 12–48 Vdc/20–60 Vac	E42DIR1260
AC/DC Powered Compact Rectangular LCD	
Elapsed hour meter, 48–150 Vdc/100–230 Vac	E42DI2448230
Elapsed hour meter, w/reset, 48–150 Vdc/100–230 Vac	E42DI2448230R
Elapsed hour meter, 12–48 Vdc/20–60 Vac	E42DI241260

Product Overview

Totalizers Selection Guide



Description	Electromechanical Micro Page V9-T3-59	SE Series Page V9-T3-59	E5-024-C Series Page V9-T3-60	E5-x24-E Series Page V9-T3-60
Display type	Mechanical	Mechanical	LCD	LED
Number of digits	7	6	8	6
Power supply	12 Vdc	12 or 24 Vdc, 120 or 240 Vac	Internal battery	10–30 Vdc
Mounting configuration(s)	Front panel (13 x 30 mm cut-out)	Base mount, bottom mount, top mount, or front panel mount	Front panel 22 x 45 mm (1/32 DIN)	Front panel 22 x 45 mm (1/32 DIN)
Maximum counting speed	25 Hz	10 Hz	12 kHz	20 kHz
Count reset method(s)	—	—	Front panel or electronic, can be locked out	Front panel or electronic, can be locked out
Front panel protection	IP65	—	IP65	IP65

Totalizers Selection Guide, continued



Description	Courier Series Page V9-T3-61	E5-496 Series Page V9-T3-62	Eclipse Series Page V9-T3-62
Display type	LCD	LED	LED
Number of digits	8	6	6
Power supply	Replaceable battery	10–30 Vdc or 90–260 Vac	9–30 Vdc or 85–265 Vac
Mounting configuration(s)	Front panel 68 x 33 mm	Front panel 92 x 45 mm (1/8 DIN)	Front panel 92 x 45 mm (1/8 DIN)
Maximum counting speed	10 kHz	60 kHz	8.2 kHz
Count reset method(s)	Front panel or electronic, can be locked out	Front panel or electronic, can be locked out	Front panel or electronic, can be locked out
Front panel protection	Type 4X	IP65	Type 4X

For our complete product offering, see Volume 7—Logic Control, Operator Interface and Connectivity Solutions, CA08100008E and PG05400001E.

Electromechanical Totalizers



Features

- Micro display
- Low power consumption; suitable for battery consumption
- Small dimensions
- Long service life

SE Series

- Low-cost electromechanical counter
- Multiple voltage ranges for almost any application
- Compact with various mounting options

Catalog Number Selection

Electromechanical Totalizers

Totalizers

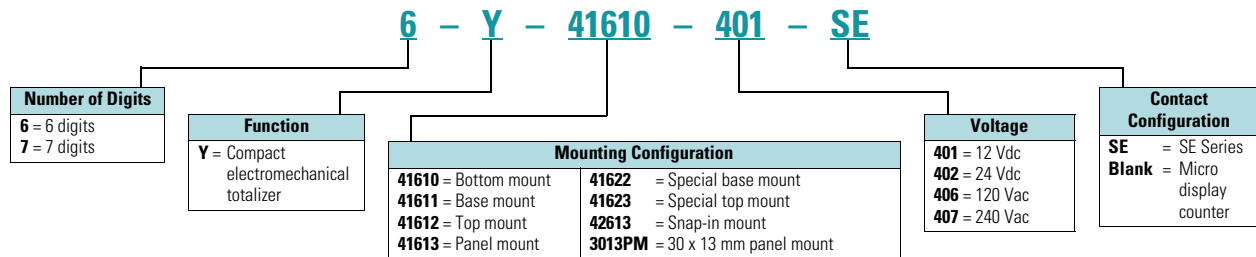

Product Selection

Micro Display Counter

Description	Catalog Number
Micro display counter—12 Vdc	7-Y-3013PM-401

SE Series Electromechanical Totalizers

Description	Catalog Number	Order Number
6-Digit Counter		
Bottom mount sub-miniature 12 Vdc	6-Y-41610-401-SE	41610401
Bottom mount sub-miniature 24 Vdc	6-Y-41610-402-SE	41610402
Bottom mount sub-miniature 120 Vac	6-Y-41610-406-SE	41610406
Bottom mount sub-miniature 240 Vac	6-Y-41610-407-SE	41610407
Base mount sub-miniature 12 Vdc	6-Y-41611-401-SE	41611401
Base mount sub-miniature 24 Vdc	6-Y-41611-402-SE	41611402
Base mount sub-miniature 120 Vac	6-Y-41611-406-SE	41611406
Base mount sub-miniature 240 Vac	6-Y-41611-407-SE	41611407
Top mount sub-miniature 12 Vdc	6-Y-41612-401-SE	41612401
Top mount sub-miniature 24 Vdc	6-Y-41612-402-SE	41612402
Top mount sub-miniature 120 Vac	6-Y-41612-406-SE	41612406
Top mount sub-miniature 240 Vac	6-Y-41612-407-SE	41612407
Panel mount sub-miniature 12 Vdc	6-Y-41613-401-SE	41613401
Panel mount sub-miniature 24 Vdc	6-Y-41613-402-SE	41613402

Description	Catalog Number	Order Number
6-Digit Counter, continued		
Panel mount sub-miniature 120 Vac	6-Y-41613-406-SE	41613406
Panel mount sub-miniature 240 Vac	6-Y-41613-407-SE	41613407
Special base mount sub-miniature 12 Vdc	6-Y-41622-401-SE	41622401
Special base mount sub-miniature 24 Vdc	6-Y-41622-402-SE	41622402
Special base mount sub-miniature 120 Vac	6-Y-41622-406-SE	41622406
Special base mount sub-miniature 240 Vac	6-Y-41622-407-SE	41622407
Special top mount sub-miniature 12 Vdc	6-Y-41623-401-SE	41623401
Special top mount sub-miniature 24 Vdc	6-Y-41623-402-SE	41623402
Special top mount sub-miniature 120 Vac	6-Y-41623-406-SE	41623406
Special top mount sub-miniature 240 Vac	6-Y-41623-407-SE	41623407
Snap-in mount sub-miniature 12 Vdc	6-Y-42613-401-SE	42613401
Snap-in mount sub-miniature 24 Vdc	6-Y-42613-402-SE	42613402
Snap-in mount sub-miniature 120 Vac	6-Y-42613-406-SE	42613406
Snap-in mount sub-miniature 240 Vac	6-Y-42613-407-SE	42613407

Electronic 1/32 DIN Totalizers



Features

Battery powered LCD

- Low price and high efficiency
- Large 8-digit LCD display, height of the figures 0.31 in (8 mm)
- Lifetime of the battery is approximately 8 years

DC Powered LED

- Display counter adding and subtracting
- Position display
- Frequency counter/ratemeter
- Timer
- Supply voltage: 10–30 Vdc with reverse polarity protection
- Polarity of inputs: programmable, NPN or PNP

Catalog Number Selection

Electronic 1/32 DIN Totalizers

Electronic Totalizers

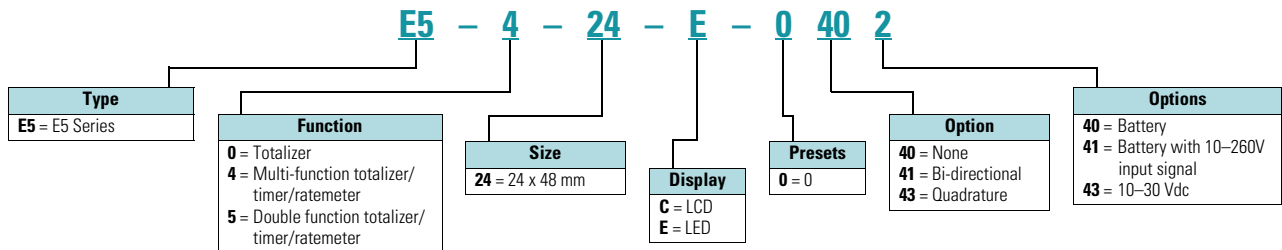

Product Selection

1/32 DIN LCD Totalizers

Description	Catalog Number
Battery Powered 8-Digit LCD Totalizer	
0.94 x 1.89 in (24 x 48 mm) LCD totalizer	E5-024-C0400
10–260V input 0.94 x 1.89 in (24 x 48 mm) LCD totalizer	E5-024-C0408
Count up/down 0.94 x 1.89 in (24 x 48 mm) LCD totalizer	E5-024-C0410
DC Powered 6-Digit LED Totalizer	
LED single channel totalizer, 10–30 Vdc power 0.94 x 1.89 in (24 x 48 mm)	E5-024-E0402
LED multifunction totalizer/timer/ratemeter, 10–30 Vdc power 0.94 x 1.89 in (24 x 48 mm)	E5-424-E0402
LED double-function totalizer/timer/ratemeter, 10–30 Vdc power 0.94 x 1.89 in (24 x 48 mm)	E5-524-E0402
LED totalizer with quadrature, 10–30 Vdc power 0.94 x 1.89 in (24 x 48 mm)	E5-024-E0432

Electronic Courier Series Battery Powered LCD Totalizers



Features

- 8-digit totalizer
- 1/Tau ratemeter is an additional capability on the 53300405 only
- Scaling capabilities
- Remote reset terminal
- Type 4X protection
- Internal battery: 3V, lithium, replaceable battery

Catalog Number Selection

Electronic Courier Series Battery Powered LCD Totalizers

Courier Series

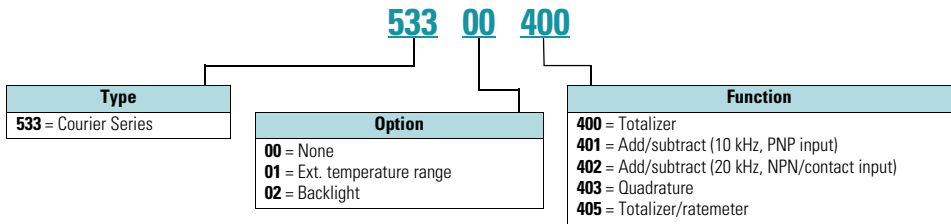

Product Selection

Courier Series, 8-Digit LCD Totalizers

Description	Catalog Number
Totalizer, battery	53300400
Add/subtract (10k Hz, PNP input) totalizer, battery	53300401
Add/subtract (20 Hz, NPN/contact input) totalizer, battery	53300402
Quadrature (10k Hz, PNP input) totalizer, battery	53300403
Totalizer/ratemeter, battery	53300405

Electronic 1/8 DIN LED Totalizers**Features**

LED Multifunction

- Display counter adding and subtracting
- Position display
- Frequency counter/ratemeter
- Display: 6-digit red, 7-segment LED display; 0.55 in (14 mm) high
- Polarity of inputs: programmable, NPN or PNP for all inputs

Eclipse Series

- 1/8 DIN cutout
- Type 4X front panel protection
- Front panel programming

Product Selection**Electronic 1/8 DIN LED Totalizers****1/8 DIN LED Totalizers**

Description	Catalog Number
LED Multifunction Counter/Timer/Ratemeter	
90–260 Vac power 3.78 x 1.89 in (96 x 48 mm)	E5-496-E0401
10–30 Vdc power 3.78 x 1.89 in (96 x 48 mm)	E5-496-E0402
Eclipse Series LED Totalizer	
9–30 Vdc power	57700480
85–265 Vac power	57701480
Analog out, 9–30 Vdc power	57700482
Analog out, 85–265 Vac power	57701482
RS-485 out, 9–30 Vdc power	57700484
RS-485 out, 85–265 Vac power	57701484
RS-485 out and analog out, 9–30 Vdc power	57700486
RS-485 out and analog out, 85–265 Vac power	57701486

Product Overview

Encoders Selection Guide



Description	Cube	Right-Angled
	Page V9-T3-64	Page V9-T3-64
Power supply	5–28 Vdc	5–28 Vdc
Output signal	NPN transistor	NPN transistor
Pulses per revolution	Up to 600	Up to 1,800
Maximum shaft speed	6000 RPM	8000 RPM
Mounting configuration(s)	Face or base mounted	Flange mounted
Shaft size	3/8 in	3/8 in
Maximum axial loading	10 lbs	80 lbs
Quadrature output available	Yes	Yes

For our complete product offering, see Volume 7—Logic Control, Operator Interface and Connectivity Solutions, CA08100008E and PG05400001E.

Shaft Encoders



Features

Cube style

- 5–28 Vdc input power
- Single channel and quadrature models
- 3/8 in (9.5 mm) double-ended shaft

Right-angled

- 5–28 Vdc input power
- Quadrature output, two square waves
- Flange mounting
- 3/8 in (9.5 mm) shaft diameter

Product Selection

Shaft Encoders

Cube Shaft Encoders

Description	Catalog Number
Single Channel	
60 pulses per revolution	38150060
100 pulses per revolution	38150100
120 pulses per revolution	38150120
600 pulses per revolution	38150600
Quadrature	
60 pulses per revolution	38151060
100 pulses per revolution	38151100
120 pulses per revolution	38151120
600 pulses per revolution	38151600

Right-Angled Shaft Encoders, Size 20

Description	Catalog Number
100 pulses per revolution	38159100
120 pulses per revolution	38159120
600 pulses per revolution	38159600
1000 pulses per revolution	381591000
1800 pulses per revolution	381591800

Pushbuttons and Pilot Devices



Stacklights



Panel Meters



Operator Interfaces and Programming Software



4.1 Pushbutton and Pilot Devices	
Product Overview	V9-T4-2
M22—22.5 mm Modular Pushbutton.....	V9-T4-4
10250T—30 mm Pushbuttons	V9-T4-37
4.2 Stacklights	
Product Overview	V9-T4-49
E26 Stacklights	V9-T4-50
4.3 Panel Meters	
Product Overview	V9-T4-54
Digital Panel Meters	V9-T4-55
4.4 Operator Interfaces and Programming Software	
Product Overview	V9-T4-56
ELC-GP Graphics Panel	V9-T4-59
HMi Operator Interface	V9-T4-60
XV Operator Interface	V9-T4-62
XP Operator Interface	V9-T4-65

For our complete product offering, see Volume 7—Logic Control, Operator Interface and Connectivity Solutions, CA08100008E.

Product Overview

Pushbuttons and Pilot Devices Selection Guide



M22—22.5 mm Modular Pushbuttons



10250T—30 mm Pushbuttons

Description	M22—22.5 mm Modular Pushbuttons Page V9-T4-4	10250T—30 mm Pushbuttons Page V9-T4-37
Ease of Use		
Mounting nut on operator installation	Yes	Yes
Mounting adapter installation/removal	Easy	—
Contact block installation	Snaps on mounting adapter	Screw in
Contact block/light unit installation/removal	Easy	Easy
Visible actuator indication from rear	Yes	Yes
Optional spring cage terminations	Yes	—
Optional quick-connect terminations	Yes	Yes
Built-in or separate anti-rotation locking ring installation	Built-in	Built-in
Mounting time	Low	Low
Removal time	Low	Low
Flexibility and Modularity		
Field convertible pushbuttons—color or inscribed button caps	Yes	—
Field convertible pushbuttons—maintained to momentary	Yes	—
Field convertible selector switches—momentary to maintained	Yes	—
Field convertible key selector switches—key removal position	Yes	—
Universal voltage range LED light units ^①	Yes	—
Stackable contact blocks	Yes	—
Enclosed limit switch contacts ^②	Yes	—
Safety and Security		
ISO/EN 13850/EN 418 rated E-stops	Yes	Yes
Safety yellow E-stop enclosures	Yes	—
Secure anti-rotation mounting	Good	Good
Self-monitoring contact blocks	Yes, available 4Q 2010	No
Communications		
ASi bus network communications	Yes	—
DeviceNet network communications	—	—
PROFIBUS-DP network communications	—	—
Esthetics and Ergonomics		
Low profile design	Yes	—
Low power integrated LED illuminated devices	Yes	—
Permanent and wear-resistant markings	Yes	—
Square bezel pushbuttons and pilot lights	—	—

Notes

^① Eaton's M22 LED light units come in two convenient universal ranges: 12–30 Vac/Vdc and 85–244 Vac.

^② Eaton's M22 pushbutton, selector switch, and E-stop operators can be attached directly to Eaton's LS Series miniature limit switches.

For our complete product offering, see Volume 7—Logic Control, Operator Interface and Connectivity Solutions, CA08100008E.

Pushbuttons and Pilot Devices Selection Guide, continued



M22—22.5 mm Modular Pushbuttons



10250T—30 mm Pushbuttons

Description	M22—22.5 mm Modular Pushbuttons	10250T—30 mm Pushbuttons
Esthetics and Ergonomics		
Positive detent on selector switches	Very good	Fair
Ergonomic dome shaped E-stop and palm switches	Yes	—
Specialty Operator Types		
Acoustic indicators (buzzers)	Yes	—
Double pushbutton operators	Yes	No
Elevator E-stops (with mechanical flag indication)	Yes	—
EMO E-stops	—	No
Four-way pushbutton operators	Yes	—
Joysticks	Yes	—
Potentiometers	Yes	Yes
Reset pushbutton operators	Yes	Yes
Selector pushbutton (roto-push) operators	—	—
Selector switches with key monitoring	—	—
Toggle switches	—	—
Standards and Certifications		
China Compulsory Certification—CCC (China)	Yes	—
Conformité Européenne—CE (Europe)	Yes	Yes
Canadian Standard Association—CSA (Canada)	Yes	Yes
Gosudarstvennyy Standart Russia—GOST R (Russia)	Yes	—
Underwriter's Laboratories—UL (United States)	Yes	Yes
Marine Classification Societies		
American Bureau of Shipping—ABS (United States)	—	—
Bureau Veritas—BV (France)	Yes	—
Det Norske Veritas—DNV (Norway)	Yes	—
Germanischer Lloyd—GL (Germany)	Yes	—
Lloyd's Register—LR (United Kingdom)	Yes	—
Polski Regestre Statkow—PRS (Poland)	—	—
Registro Italiano Navale—RINA (Italy)	—	—
Russian Maritime Register of Shipping—RMRS (CIS)	—	—
Accessories		
USB socket bulkhead interface	Yes	—
RJ45 socket bulkhead interface	Yes	—
Padlock attachments for pushbuttons	—	Yes
Padlock attachments for selector switches	—	Yes
Padlock attachments for E-stops	No	—
Protective shrouds for E-stops	Yes	Yes
DIN rail mounting adapter	Yes	—

For our complete product offering, see Volume 7—Logic Control, Operator Interface and Connectivity Solutions, CA08100008E.

4.1

Operator Interface

Pushbutton and Pilot Devices

M22—22.5 mm Modular Pushbutton



4

Features

Highly modular and versatile line

- Field convertible functions (pushbuttons and selector switches), maintained to momentary
- Customizable laser engraving capabilities

LED indicators

- 100,000 hours of life in high-vibration environments
- Lenses specifically designed for LED illumination

Rugged design

- Most pushbutton operators and contact blocks exceed 5 million mechanical operations
- All components have IP66 rating, and some carry IP67 and IP69K for washdown environment; see Volume 7—Logic Control, Operator Interface and Connectivity Solutions, CA08100008E, Tab 1 for further technical data

Innovative technologies

- ASi communicating devices
- Palm switches

Standards and Certifications



Product Selection

Non-Illuminated Pushbuttons, Flush, Momentary

Complete Devices

	Bezel	Button Color	Contact Block Configuration ^①	Catalog Number
M22-D-G-K10 	Silver	Black	NO	M22-D-S-K10
			NC	M22-D-S-K01
			2NO	M22-D-S-K20
			2NC	M22-D-S-K02
			1NO-1NC	M22-D-S-K11
		Red	NO	M22-D-R-K10
			NC	M22-D-R-K01
			2NO	M22-D-R-K20
			2NC	M22-D-R-K02
			1NO-1NC	M22-D-R-K11
		Green	NO	M22-D-G-K10
			NC	M22-D-G-K01
			2NO	M22-D-G-K20
			2NC	M22-D-G-K02
			1NO-1NC	M22-D-G-K11
M22S-D-G-K10 	Black	Black	NO	M22S-D-S-K10
			NC	M22S-D-S-K01
			2NO	M22S-D-S-K20
			2NC	M22S-D-S-K02
			1NO-1NC	M22S-D-S-K11
		Red	NO	M22S-D-R-K10
			NC	M22S-D-R-K01
			2NO	M22S-D-R-K20
			2NC	M22S-D-R-K02
			1NO-1NC	M22S-D-R-K11
		Green	NO	M22S-D-G-K10
			NC	M22S-D-G-K01
			2NO	M22S-D-G-K20
			2NC	M22S-D-G-K02
			1NO-1NC	M22S-D-G-K11

Note

^① All NC contact blocks are positively driven contact. (⊖)

Non-Illuminated Pushbuttons, Flush

Components

M22-XD-G





Button Plates ①

Color	Inscription	Catalog Number
Black	—	M22-XD-S ②
	Custom	M22-XD-S-ETCH ③
	STOP	M22-XD-S-GB0
	START	M22-XD-S-GB1
	CLOSE	M22-XD-S-GB2
	UP	M22-XD-S-GB3
	DOWN	M22-XD-S-GB4
	OFF	M22-XD-S-GB5
	ON	M22-XD-S-GB6
	TEST	M22-XD-S-GB9
	FORWARD	M22-XD-S-GB15
	REVERSE	M22-XD-S-GB16
	RAISE	M22-XD-S-GB17
	LOWER	M22-XD-S-GB18
	⊙	M22-XD-S-X0
	①	M22-XD-S-X1
②	M22-XD-S-X2	
+	M22-XD-S-X4	
⊖	M22-XD-S-X5	
①	M22-XD-S-X7	
Red	—	M22-XD-R ②
	Custom	M22-XD-R-ETCH ③
	STOP	M22-XD-R-GB0
	OFF	M22-XD-R-GB5
	⊙	M22-XD-R-X0
Green	—	M22-XD-G ②
	Custom	M22-XD-G-ETCH ③
	START	M22-XD-G-GB1
	ON	M22-XD-G-GB6
	①	M22-XD-G-X1
Blue	—	M22-XD-B ②
	Custom	M22-XD-B-ETCH ③
	RESET	M22-XD-B-GB14
	Ⓜ	M22-XD-B-X6
White	—	M22-XD-W ②
	Custom	M22-XD-W-ETCH ③
	START	M22-XD-W-GB1
	①	M22-XD-W-X1
Yellow	—	M22-XD-Y ②
	Custom	M22-XD-Y-ETCH ③
Black, red, green	—	M22-XD-SRG
Black, white, red, green, yellow, blue	—	M22-XD-SWRGB

Momentary Buttonless Operator

	Bezel	Catalog Number ④
M22-D-X	Silver	M22-D-X
		
M22S-D-X	Black	M22S-D-X
		
M22-DG-X	Silver guarded	M22-DG-X
		

Maintained Buttonless Operator ⑤

	Bezel	Catalog Number ④
M22-DR-X	Silver	M22-DR-X
		
M22S-DR-X	Black	M22S-DR-X
		

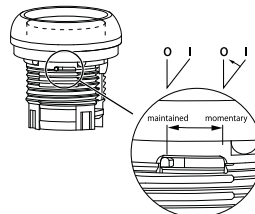

Notes

- ① For complete listing of available button plates and contact blocks, see Accessories, **Pages V9-T4-31 to V9-T4-36**.
- ② Minimum order quantity of (10).
- ③ When ordering, specify inscription per catalog number suffix from the Symbols Library (see Volume 7—Logic Control, Operator Interface and Connectivity Solutions, CA08100008E, Tab 1) into the Order Notes. For example, M22-XD-S-ETCH; Order Notes: Mark with symbol X91, Line item #_.
- ④ Includes contact block mounting adapter.
- ⑤ Maintained pushbuttons can be converted in the field to momentary operation by switching the locking ring, which is accessible through the side of the operator body.



Non-Illuminated Pushbuttons, Extended, Momentary

Complete Devices

	Bezel	Button Color	Contact Block Configuration ^①	Catalog Number
M22-DH-R-K10 	Silver	Red	NO	M22-DH-R-K10
			NC	M22-DH-R-K01
			2NO	M22-DH-R-K20
			2NC	M22-DH-R-K02
			1NO-1NC	M22-DH-R-K11
M22S-DH-R-K10 	Black	Red	NO	M22S-DH-R-K10
			NC	M22S-DH-R-K01
			2NO	M22S-DH-R-K20
			2NC	M22S-DH-R-K02
			1NO-1NC	M22S-DH-R-K11
M22-DGH-R-K10 	Silver guarded	Red	NO	M22-DGH-R-K10
			NC	M22-DGH-R-K01
			2NO	M22-DGH-R-K20
			2NC	M22-DGH-R-K02
			1NO-1NC	M22-DGH-R-K11

Note

^① All NC contact blocks are positively driven contact. ⊖

Non-Illuminated Pushbuttons, Extended

Components

M22-XDH-R



Button Plates ^①

Color	Inscription	Catalog Number
Black	—	M22-XDH-S ^②
	Custom	M22-XDH-S-ETCH ^③
	STOP	M22-XDH-S-GB0
	START	M22-XDH-S-GB1
	CLOSE	M22-XDH-S-GB2
	UP	M22-XDH-S-GB3
	DOWN	M22-XDH-S-GB4
	OFF	M22-XDH-S-GB5
	ON	M22-XDH-S-GB6
	TEST	M22-XDH-S-GB9
	FORWARD	M22-XDH-S-GB15
	REVERSE	M22-XDH-S-GB16
	RAISE	M22-XDH-S-GB17
	LOWER	M22-XDH-S-GB18
	⊙	M22-XDH-S-X0
	①	M22-XDH-S-X1
	②	M22-XDH-S-X2
⊕	M22-XDH-S-X4	
⊖	M22-XDH-S-X5	
①	M22-XDH-S-X7	
Red	—	M22-XDH-R ^②
	Custom	M22-XDH-R-ETCH ^③
	STOP	M22-XDH-R-GB0
	OFF	M22-XDH-R-GB5
	⊙	M22-XDH-R-X0
Green	—	M22-XDH-G ^②
	Custom	M22-XDH-G-ETCH ^③
	START	M22-XDH-G-GB1
	ON	M22-XDH-G-GB6
Blue	—	M22-XDH-B ^②
	Custom	M22-XDH-B-ETCH ^③
	RESET	M22-XDH-B-GB14
White	Ⓡ	M22-XDH-B-X6
	—	M22-XDH-W ^②
	Custom	M22-XDH-W-ETCH ^③
Yellow	START	M22-XDH-W-GB1
	①	M22-XDH-W-X1
	—	M22-XDH-Y ^②
Black, red, green	Custom	M22-XDH-Y-ETCH ^③
	—	M22-XDH-SRG
Black, white, red, green, yellow, blue	—	M22-XDH-SWRGYB

Momentary Buttonless Operator

Bezel	Catalog Number ^④
Silver	M22-D-X
Black	M22S-D-X
Silver guarded	M22-DG-X

M22-D-X



M22S-D-X



M22-DG-X



Maintained Buttonless Operator ^⑤

Bezel	Catalog Number ^④
Silver	M22-DR-X
Black	M22S-DR-X

M22-DR-X



M22S-DR-X



Notes

- For complete listing of available button plates and contact blocks, see Accessories, Pages V9-T4-31 to V9-T4-36.
- Minimum order quantity of (10).
- When ordering, specify inscription per catalog number suffix from the Symbols Library (see Volume 7—Logic Control, Operator Interface and Connectivity Solutions, CA08100008E, Tab 1) into the Order Notes. For example, M22-XDH-S-ETCH; Order Notes: Mark with symbol X91, Line item #_.
- Includes contact block mounting adapter.
- Maintained pushbuttons can be converted in the field to momentary operation by switching the locking ring, which is accessible through the side of the operator body.

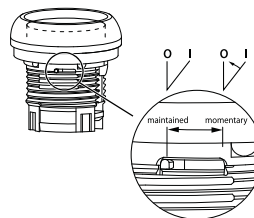

Illuminated Pushbuttons, Flush, Momentary

Complete Devices

	Bezel	Button Color	Contact Block Configuration ^①	Light Unit Voltage	Catalog Number
	Silver	Red	NC	12–30 Vac/Vdc	M22-DL-R-K01-R
			NC	85–264 Vac	M22-DL-R-K01-230R
			2NC	12–30 Vac/Vdc	M22-DL-R-K02-R
			2NC	85–264 Vac	M22-DL-R-K02-230R
			1NO/1NC	12–30 Vac/Vdc	M22-DL-R-K11-R
			1NO/1NC	85–264 Vac	M22-DL-R-K11-230R
	Green	Green	NO	12–30 Vac/Vdc	M22-DL-G-K10-G
			NO	85–264 Vac	M22-DL-G-K10-230G
			2NO	12–30 Vac/Vdc	M22-DL-G-K20-G
			2NO	85–264 Vac	M22-DL-G-K20-230G
			1NO/1NC	12–30 Vac/Vdc	M22-DL-G-K11-G
			1NO/1NC	85–264 Vac	M22-DL-G-K11-230G
	White	White	NO	12–30 Vac/Vdc	M22-DL-W-K10-W
			NO	85–264 Vac	M22-DL-W-K10-230W
			2NO	12–30 Vac/Vdc	M22-DL-W-K20-W
			2NO	85–264 Vac	M22-DL-W-K20-230W
			1NO/1NC	12–30 Vac/Vdc	M22-DL-W-K11-W
			1NO/1NC	85–264 Vac	M22-DL-W-K11-230W
	Black	Red	NC	12–30 Vac/Vdc	M22S-DL-R-K01-R
			NC	85–264 Vac	M22S-DL-R-K01-230R
			2NC	12–30 Vac/Vdc	M22S-DL-R-K02-R
			2NC	85–264 Vac	M22S-DL-R-K02-230R
			1NO/1NC	12–30 Vac/Vdc	M22S-DL-R-K11-R
			1NO/1NC	85–264 Vac	M22S-DL-R-K11-230R
	Green	Green	NO	12–30 Vac/Vdc	M22S-DL-G-K10-G
			NO	85–264 Vac	M22S-DL-G-K10-230G
			2NO	12–30 Vac/Vdc	M22S-DL-G-K20-G
			2NO	85–264 Vac	M22S-DL-G-K20-230G
			1NO/1NC	12–30 Vac/Vdc	M22S-DL-G-K11-G
			1NO/1NC	85–264 Vac	M22S-DL-G-K11-230G
	White	White	NO	12–30 Vac/Vdc	M22S-DL-W-K10-W
			NO	85–264 Vac	M22S-DL-W-K10-230W
			2NO	12–30 Vac/Vdc	M22S-DL-W-K20-W
			2NO	85–264 Vac	M22S-DL-W-K20-230W
			1NO/1NC	12–30 Vac/Vdc	M22S-DL-W-K11-W
			1NO/1NC	85–264 Vac	M22S-DL-W-K11-230W

Note

^① All NC contact blocks are positively driven contact. ⊖

Illuminated Pushbuttons, Flush

Components

M22-XDL-G



Button Lenses ^①

Color	Inscription	Catalog Number
Red	—	M22-XDL-R ^②
	Custom	M22-XDL-R-ETCH ^③
	STOP	M22-XDL-R-GB0
	OFF	M22-XDL-R-GB5
	⊙	M22-XDL-R-X0
Green	—	M22-XDL-G ^②
	Custom	M22-XDL-G-ETCH ^③
	START	M22-XDL-G-GB1
	ON	M22-XDL-G-GB6
	①	M22-XDL-G-X1
Blue	—	M22-XDL-B ^②
	Custom	M22-XDL-B-ETCH ^③
	RESET	M22-XDL-B-GB14
	Ⓜ	M22-XDL-B-X6
White	—	M22-XDL-W ^②
	Custom	M22-XDL-W-ETCH ^③
Yellow	—	M22-XDL-Y ^②
	Custom	M22-XDL-Y-ETCH ^③

Momentary Buttonless Operator

Bezel Catalog Number ^④

M22-DL-X



Silver

M22-DL-X

M22S-DL-X



Black

M22S-DL-X

M22-DGL-X



Silver guarded

M22-DGL-X

Maintained Buttonless Operator ^⑤

Bezel Catalog Number ^④

M22-DRL-X



Silver

M22-DRL-X

M22S-DRL-X



Black

M22S-DRL-X

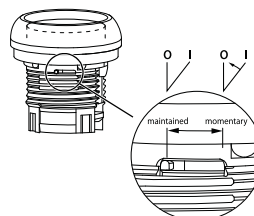

Notes

- ① For complete listing of available button plates and contact blocks, see Accessories, **Pages V9-T4-31 to V9-T4-36**.
- ② Minimum order quantity of (10).
- ③ When ordering, specify inscription per catalog number suffix from the Symbols Library (see Volume 7—Logic Control, Operator Interface and Connectivity Solutions, CA08100008E, Tab 1) into the Order Notes. For example, M22-XDL-R-ETCH; Order Notes: Mark with symbol X91, Line item #_.
- ④ Includes contact block mounting adapter.
- ⑤ Maintained pushbuttons can be converted in the field to momentary operation by switching the locking ring, which is accessible through the side of the operator body.



Illuminated Pushbuttons, Extended, Momentary

Complete Devices

	Bezel	Button Color	Contact Block Configuration ^①	Light Unit Voltage	Catalog Number
M22-DLH-R-K11-R 	Silver	Red	1NO/1NC	12–30 Vac/Vdc	M22-DLH-R-K11-R
			1NO/1NC	85–264 Vac	M22-DLH-R-K11-230R
	Black	Green	2NO	12–30 Vac/Vdc	M22-DLH-G-K20-G
			2NO	85–264 Vac	M22-DLH-G-K20-230G
		White	2NO	12–30 Vac/Vdc	M22-DLH-W-K20-W
			2NO	85–264 Vac	M22-DLH-W-K20-230W
M22S-DLH-R-K11-R 	Black	Red	1NO/1NC	12–30 Vac/Vdc	M22S-DLH-R-K11-R
			1NO/1NC	85–264 Vac	M22S-DLH-R-K11-230R
	Black	Green	2NO	12–30 Vac/Vdc	M22S-DLH-G-K20-G
			2NO	85–264 Vac	M22S-DLH-G-K20-230G
		White	2NO	12–30 Vac/Vdc	M22S-DLH-W-K20-W
			2NO	85–264 Vac	M22S-DLH-W-K20-230W

Note

^① All NC contact blocks are positively driven contact. ⊖

Illuminated Pushbuttons, Extended

Components

M22-XDH-R





Button Lenses ①

Color	Inscription	Catalog Number
Red	—	M22-XDLH-R ②
	Custom	M22-XDLH-R-ETCH ③
	STOP	M22-XDLH-R-GB0
	OFF	M22-XDLH-R-GB5
	Ⓞ	M22-XDLH-R-X0
Green	—	M22-XDLH-G ②
	Custom	M22-XDLH-G-ETCH ③
	START	M22-XDLH-G-GB1
	ON	M22-XDLH-G-GB6
	Ⓛ	M22-XDLH-G-X1
Blue	—	M22-XDLH-B ②
	Custom	M22-XDLH-B-ETCH ③
	RESET	M22-XDLH-B-GB14
	Ⓜ	M22-XDLH-B-X6
White	—	M22-XDLH-W ②
	Custom	M22-XDLH-W-ETCH ③
Yellow	—	M22-XDLH-Y ②
	Custom	M22-XDLH-Y-ETCH ③

Momentary Buttonless Operator

	Bezel	Catalog Number ④
M22-DL-X	Silver	M22-DL-X
		
M22S-DL-X	Black	M22S-DL-X
		
M22-DGL-X	Silver guarded	M22-DGL-X
		

Maintained Buttonless Operator ⑤

	Bezel	Catalog Number ④
M22-DRL-X	Silver	M22-DRL-X
		
M22S-DRL-X	Black	M22S-DRL-X
		

Notes

- ① For complete listing of available button plates and contact blocks, see Accessories, **Pages V9-T4-31 to V9-T4-36**.
- ② Minimum order quantity of (10).
- ③ When ordering, specify inscription per catalog number suffix from the Symbols Library (see Volume 7—Logic Control, Operator Interface and Connectivity Solutions, CA08100008E, Tab 1) into the Order Notes. For example, M22-XDH-S-ETCH; Order Notes: Mark with symbol X91, Line item #_.
- ④ Includes contact block mounting adapter.
- ⑤ Maintained pushbuttons can be converted in the field to momentary operation by switching the locking ring, which is accessible through the side of the operator body.

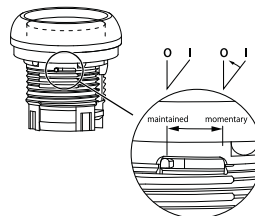

Indicating Lights, Flush

M22-L-R-R



Complete Devices

Lens Color	Light Color	Light Unit Voltage	Catalog Number
White	White	12–30 Vac/Vdc	M22-L-W-W
Red	Red		M22-L-R-R
Green	Green		M22-L-G-G
Yellow	White		M22-L-Y-W
Blue	Blue		M22-L-B-B
Amber	White		M22-L-A-W
White	White	85–264 Vac	M22-L-W-230W
Red	Red		M22-L-R-230R
Green	Green		M22-L-G-230G
Yellow	White		M22-L-Y-230W
Blue	Blue		M22-L-B-230B
Amber	White		M22-L-A-230W

M22S-DLH-R-K11-R



Complete Press-to-Test Units

Bezel	Button Color	Light Unit Voltage	Catalog Number
Silver	Red	12–30 Vac/Vdc	M22-T-R-R
	Blue		M22-T-B-B
	Yellow		M22-T-Y-W
	Green		M22-T-G-G
	White		M22-T-W-W
	Red	85–264 Vac	M22-T-R-230R
	Blue		M22-T-R-230B
	Yellow		M22-T-Y-230W
	Green		M22-T-G-230G
	White		M22-T-W-230W
Black	Red	12–30 Vac/Vdc	M22S-T-R-R
	Blue		M22S-T-B-B
	Yellow		M22S-T-Y-W
	Green		M22S-T-G-G
	White		M22S-T-W-W
	Red	85–264 Vac	M22S-T-R-230R
	Blue		M22S-T-B-230B
	Yellow		M22S-T-Y-230W
	Green		M22S-T-G-230G
	White		M22S-T-W-230W

Components

M22-XL-R

Lenses ^①

Color	Inscription	Catalog Number
Red	—	M22-XL-R ^②
	Custom	M22-XL-R-ETCH ^③
	OFF	M22-XL-R-GB5
Green	—	M22-XL-G ^②
	Custom	M22-XL-G-ETCH ^③
	ON	M22-XL-G-GB6
	REVERSE	M22-XL-G-GB16
Blue	—	M22-XL-B ^②
	Custom	M22-XL-B-ETCH ^③
	FAULT	M22-XL-B-GB8
White	—	M22-XL-W ^②
	Custom	M22-XL-W-ETCH ^③
	OFF	M22-XL-W-GB5
	ON	M22-XL-W-GB6
	FAULT	M22-XL-W-GB8
	FORWARD	M22-XL-W-GB15
Yellow	—	M22-XL-Y ^②
	Custom	M22-XL-Y-ETCH ^③
Amber	—	M22-XL-A ^②
	Custom	M22-XL-A-ETCH ^③

M22-L-X



Lensless Indicating Light

Catalog Number

M22-L-X

Notes

- ① For complete listing of available lenses and light units, see Accessories, **Pages V9-T4-31 to V9-T4-36**.
- ② Minimum order quantity of (10).
- ③ When ordering, specify inscription per catalog number suffix from the Symbols Library (see Volume 7—Logic Control, Operator Interface and Connectivity Solutions, CA08100008E, Tab 1) into the Order Notes. For example, M22-XL-R-ETCH; Order Notes: Mark with symbol X91, Line item #_.

Non-Illuminated Emergency Stops

M22-PV-K01

Complete Devices



Type	Color	Contact Block Configuration ^①	Catalog Number
Push-pull	Red	NC	M22-PV-K01
		2NC	M22-PV-K02
		1NO-2NC	M22-PV-K12
Twist-to-release	Red	NC	M22-PVT-K01
		2NC	M22-PVT-K02
		1NO-2NC	M22-PVT-K12
Key release	Red	NC	M22-PVS-K01
		2NC	M22-PVS-K02
		1NO-2NC	M22-PVS-K12

Components

Operators Only ^②

M22-PV



Type	Color	Catalog Number
Push-pull	Red	M22-PV
	Black	M22S-PV

M22S-PVT



Twist-to-release	Red	M22-PVT
	Black	M22S-PVT

Key release ^③	Red	M22-PVS ^④
		M22-PVS-MS2
		M22-PVS-MS3
		M22-PVS-MS4
		M22-PVS-MS5
		M22-PVS-MS6
		M22-PVS-MS7
		M22-PVS-MS8

Notes

- ① All NC contact blocks are positively driven contact. ↻
- ② Includes contact block mounting adapter.
- ③ Key included. For identical locks and keys, use the same key code. One key is included with actuator; additional keys are available as accessories.
- ④ Includes Key Code MS1.

Illuminated Emergency Stops

M22-PVL-K01-R

Complete Devices



Type	Button Color	LED Color	Contact Block Configuration ^①	Light Unit Voltage	Catalog Number			
Push-pull	Red	Red	NC	12–30 Vac/Vdc	M22-PVL-K01-R			
			2NC	12–30 Vac/Vdc	M22-PVL-K02-R			
			1NO-2NC	12–30 Vac/Vdc	M22-PVL-K12-R			
			NC	85–264 Vac	M22-PVL-K01-230R			
			2NC	85–264 Vac	M22-PVL-K02-230R			
			1NO-2NC	85–264 Vac	M22-PVL-K12-230R			
			Twist-to-release			NC	12–30 Vac/Vdc	M22-PVLT-K01-R
						2NC	12–30 Vac/Vdc	M22-PVLT-K02-R
						1NO-2NC	12–30 Vac/Vdc	M22-PVLT-K12-R
NC	85–264 Vac	M22-PVLT-K01-230R						
2NC	85–264 Vac	M22-PVLT-K02-230R						
1NO-2NC	85–264 Vac	M22-PVLT-K12-230R						

Components

Operators Only ^②

M22-PVL



Type	Color	Catalog Number
Push-pull	Red	M22-PVL
	Black	M22S-PVL

M22S-PVLT



Type	Color	Catalog Number
Twist-to-release	Red	M22-PVLT
	Black	M22S-PVLT

Notes

- ① All NC contact blocks are positively driven contact. ⊖
- ② Includes contact block mounting adapter.

Non-Illuminated Selector Switches

M22-WKV-K10

Complete Devices, Knob Type ^①



Type	Switching Position	Bezel	Contact Block Configuration ^②	Catalog Number
Two-position	Maintained 	Silver	NO	M22-WRK-K10
			1NO-1NC	M22-WRK-K11
			2NO-2NC	M22-WRK-K22
		Black	NO	M22S-WRK-K10
			1NO-1NC	M22S-WRK-K11
			2NO-2NC	M22S-WRK-K22
	Maintained V 	Silver	NO	M22-WKV-K10
			1NO-1NC	M22-WKV-K11
			2NO-2NC	M22-WKV-K22
		Black	NO	M22S-WKV-K10
			1NO-1NC	M22S-WKV-K11
			2NO-2NC	M22S-WKV-K22
Three-position	Maintained 	Silver	2NO	M22-WRK3-K20
			2NO-2NC	M22-WRK3-K22
			Black	2NO
		2NO-2NC	M22S-WRK3-K22	

Notes

^① Includes contact block mounting adapter.

^② All NC contact blocks are positively driven contact.

Non-Illuminated Selector Switches, continued

Components

M22-WK



4

Operators Only, Knob Type ①

Type	Switching Position	Bezel	Catalog Number	
Two-position	Momentary ②	Silver	M22-WK	
		Black	M22S-WK	
	Maintained	Silver	M22-WRK	
		Black	M22S-WRK	
	Maintained V	Silver	M22-WKV	
		Black	M22S-WKV	
Three-position	Momentary ②	Silver	M22-WK3	
		Black	M22S-WK3	
	Maintained	Silver	M22-WRK3	
		Black	M22S-WRK3	
	Maintained, return from left	Silver	M22-WRK3-2	
		Black	M22S-WRK3-2	
	Maintained, return from right	Silver	M22-WRK3-1	
		Black	M22S-WRK3-1	
	Four-position	Maintained	Silver	M22-WRK4
			Black	M22S-WRK4

Notes

- ① Includes contact block mounting adapter.
- ② Momentary selector switches can be converted in the field to maintained operation with the removal of a color coded adapter. See Volume 7—Logic Control, Operator Interface and Connectivity Solutions, CA0810008E, Tab 1.

Non-Illuminated Selector Switches, continued

Components

M22S-WR3-X94



Operators Only, Rotary Type ^①

Type	Switching Position	Bezel	Inscription	Catalog Number
Two-position	Momentary ^②	Silver	I-O	M22-W
		Black	I-O	M22S-W
	Maintained	Silver	I-O	M22-WR
			Custom	M22-WR-ETCH ^③
			AUTO-HAND	M22-WR-X91
			II-I	M22-WR-X92
		Black	I-O	M22S-WR
			Custom	M22S-WR-ETCH ^③
			AUTO-HAND	M22S-WR-X91
			II-I	M22S-WR-X92
Three-position	Momentary ^②	Silver	I-O-II	M22-W3
		Black	I-O-II	M22S-W3
	Maintained	Silver	I-O-II	M22-WR3
			Custom	M22-WR3-ETCH ^③
			AUTO-O-MAN	M22-WR3-X94
		Black	I-O-II	M22S-WR3
			Custom	M22S-WR3-ETCH ^③
			AUTO-O-MAN	M22S-WR3-X94
Four-position	Maintained	Silver	0-1-0-2-0-3-0-4	M22-WR4
		Black	0-1-0-2-0-3-0-4	M22S-WR4

Notes

- ① Includes contact block mounting adapter.
- ② Momentary selector switches can be converted in the field to maintained operation with the removal of a color coded adapter. See Volume 7—Logic Control, Operator Interface and Connectivity Solutions, CA08100008E, Tab 1.
- ③ When ordering, specify inscription per catalog number suffix from the Symbols Library (see Volume 7—Logic Control, Operator Interface and Connectivity Solutions, CA08100008E, Tab 1) into the Order Notes. For example, M22-WR3-ETCH; Order Notes: Mark with symbol X88, Line item #_.

Illuminated Selector Switches

Components

M22-WLK-W



4

Operators Only, Knob Type ^①

Type	Switching Position	Bezel	Button Color	Catalog Number
Two-position	Momentary ^② 	Silver	White	M22-WLK-W
			Red	M22-WLK-R
			Green	M22-WLK-G
			Yellow	M22-WLK-Y
			Blue	M22-WLK-B
			Black	M22S-WLK-W
	Black	White	M22S-WLK-W	
		Red	M22S-WLK-R	
		Green	M22S-WLK-G	
		Yellow	M22S-WLK-Y	
		Blue	M22S-WLK-B	
		Black	M22S-WLK-B	
	Maintained 	Silver	White	M22-WRLK-W
			Red	M22-WRLK-R
			Green	M22-WRLK-G
			Yellow	M22-WRLK-Y
			Blue	M22-WRLK-B
			Black	M22S-WRLK-W
Black	White	M22S-WRLK-W		
	Red	M22S-WRLK-R		
	Green	M22S-WRLK-G		
	Yellow	M22S-WRLK-Y		
	Blue	M22S-WRLK-B		
	Black	M22S-WRLK-B		
Maintained V 	Silver	White	M22-WLKV-W	
		Red	M22-WLKV-R	
		Green	M22-WLKV-G	
		Yellow	M22-WLKV-Y	
		Blue	M22-WLKV-B	
		Black	M22S-WLKV-W	
Black	White	M22S-WLKV-W		
	Red	M22S-WLKV-R		
	Green	M22S-WLKV-G		
	Yellow	M22S-WLKV-Y		
	Blue	M22S-WLKV-B		
	Black	M22S-WLKV-B		

Notes

- ① Includes contact block mounting adapter.
- ② Momentary selector switches can be converted in the field to maintained operation with the removal of a color coded adapter. See Volume 7—Logic Control, Operator Interface and Connectivity Solutions, CA08100008E, Tab 1.





Illuminated Selector Switches, continued

Components

M22-WLK3-W



Operators Only, Knob Type ①

Type	Switching Position	Bezel	Button Color	Catalog Number
Three-position	Momentary ② 	Silver	White	M22-WLK3-W
			Red	M22-WLK3-R
			Green	M22-WLK3-G
			Yellow	M22-WLK3-Y
			Blue	M22-WLK3-B
		Black	White	M22S-WLK3-W
			Red	M22S-WLK3-R
			Green	M22S-WLK3-G
			Yellow	M22S-WLK3-Y
			Blue	M22S-WLK3-B
Maintained		Silver	White	M22-WRLK3-W
			Red	M22-WRLK3-R
			Green	M22-WRLK3-G
			Yellow	M22-WRLK3-Y
			Blue	M22-WRLK3-B
		Black	White	M22S-WRLK3-W
			Red	M22S-WRLK3-R
			Green	M22S-WRLK3-G
			Yellow	M22S-WRLK3-Y
			Blue	M22S-WRLK3-B
Maintained, return from right		Silver	White	M22-WRLK3-1-W
			Red	M22-WRLK3-1-R
			Green	M22-WRLK3-1-G
			Yellow	M22-WRLK3-1-Y
			Blue	M22-WRLK3-1-B
		Black	White	M22S-WRLK3-1-W
			Red	M22S-WRLK3-1-R
			Green	M22S-WRLK3-1-G
			Yellow	M22S-WRLK3-1-Y
			Blue	M22S-WRLK3-1-B
Maintained, return from left		Silver	White	M22-WRLK3-2-W
			Red	M22-WRLK3-2-R
			Green	M22-WRLK3-2-G
			Yellow	M22-WRLK3-2-Y
			Blue	M22-WRLK3-2-B
		Black	White	M22S-WRLK3-2-W
			Red	M22S-WRLK3-2-R
			Green	M22S-WRLK3-2-G
			Yellow	M22S-WRLK3-2-Y
			Blue	M22S-WRLK3-2-B

Notes

- ① Includes contact block mounting adapter.
 ② Momentary selector switches can be converted in the field to maintained operation with the removal of a color coded adapter. See Volume 7—Logic Control, Operator Interface and Connectivity Solutions, CA08100008E, Tab 1.

4.1

Operator Interface







Pushbutton and Pilot Devices

Key-Operated Selector Switches ^{①②}

For additional key code options, see Volume 7—Solid-State Motor Control, CA08100008E, Tab 1.

Components

Operators Only ^③



Type	Switching Position	Key Code	Bezel	Key Removal Position	Catalog Number
M22-WS 	Two-position Momentary ^④ 	MS1	Silver	Return from right, key removable left	M22-WS
			Black	Return from right, key removable left	M22S-WS
M22S-WRS 	Two-position Maintained 	MS1	Silver	Key removable left	M22-WRS-A1
			Black	Key removable left	M22S-WRS-A1
		MS1	Silver	Key removable left/right	M22-WRS
			Black	Key removable left/right	M22S-WRS
M22-WS3-X93 	Three-position Momentary ^④ 	MS1	Silver	Return from left/right, key removable center	M22-WS3
			Black	Return from left/right, key removable center	M22S-WS3
	Maintained 	MS1	Silver	Key removable center	M22-WRS3-A1
			Black	Key removable center/left	M22-WRS3-A2
			Black	Key removable center/right	M22-WRS3-A3
			Black	Key removable left/right	M22-WRS3
			Black	Return from left, key removable center	M22-WRS3-A7
			Black	Return from left, key removable center/right	M22-WRS3-A6
			Black	Return from right, key removable left/center	M22-WRS3-A4
			Black	Return from right, key removable center	M22-WRS3-A5
	Black	MS1	Black	Key removable center	M22S-WRS3-A1
			Black	Key removable center/left	M22S-WRS3-A2
			Black	Key removable center/right	M22S-WRS3-A3
			Black	Key removable left/right/center	M22S-WRS3
			Black	Return from left, key removable center	M22S-WRS3-A7
			Black	Return from left, key removable center/right	M22S-WRS3-A6
Black			Return from right, key removable left/center	M22S-WRS3-A4	
Black			Return from right, key removable center	M22S-WRS3-A5	

Notes

- ① Includes one key.
- ② Key removal positions can be modified in the field using coding adapters; see Volume 7—Logic Control, Operator Interface and Connectivity Solutions, CA08100008E, Tab 1.
- ③ Includes contact block mounting adapter.
- ④ Momentary selector switches can be converted in the field to maintained operation with the removal of a color coded adapter. See Volume 7—Logic Control, Operator Interface and Connectivity Solutions CA08100008E, Tab 1.



Mushroom Head Pushbuttons ①

Momentary Complete Devices

	Bezel	Button Color	Contact Block Configuration ②	Catalog Number
 <p>M22-DP-R-K01</p>	Silver	Red	NC	M22-DP-R-K01
			2NC	M22-DP-R-K02
			1NO-2NC	M22-DP-R-K12
			1NO-1NC	M22-DP-R-K11
 <p>M22S-DP-R-K01</p>	Black	Red	NC	M22S-DP-R-K01
			2NC	M22S-DP-R-K02
			1NO-2NC	M22S-DP-R-K12
			1NO-1NC	M22S-DP-R-K11

Non-Illuminated Mushroom Head Pushbuttons, Maintained ① ③

Complete Devices

	Bezel	Button Color	Contact Block Configuration ④	Catalog Number
 <p>M22-DP-R-K01</p>	Silver	Red	NC	M22-DRP-R-K01
			2NC	M22-DRP-R-K02
			1NO-2NC	M22-DRP-R-K12
			1NO-1NC	M22-DRP-R-K11
 <p>M22S-DP-R-K01</p>	Black	Red	NC	M22S-DRP-R-K01
			2NC	M22S-DRP-R-K02
			1NO-2NC	M22S-DRP-R-K12
			1NO-1NC	M22S-DRP-R-K11

Notes

- ① 35 mm diameter mushroom head button.
- ② Includes contact block mounting adapter. Ⓣ
- ③ Maintained pushbuttons can be converted in the field to momentary operation by switching the locking ring, which is accessible through the side of the operator body.
- ④ All NC contact blocks are positively driven contact. Ⓣ

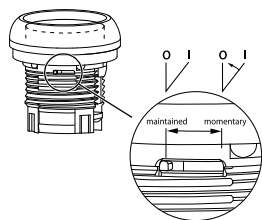

Non-Illuminated Mushroom Head Pushbuttons ①

Components

M22-XDP-G



Mushroom Head Plates

Color	Inscription	Catalog Number
Black	—	M22-XDP-S ②
	Custom	M22-XDP-S-ETCH ③
	STOP	M22-XDP-S-GB0
	START	M22-XDP-S-GB1
	FORWARD	M22-XDP-S-GB15
	REVERSE	M22-XDP-S-GB16
	UP	M22-XDP-S-GB3
	DOWN	M22-XDP-S-GB4
	OFF	M22-XDP-S-GB5
	ON	M22-XDP-S-GB6
	⊙	M22-XDP-S-X0
	⓪	M22-XDP-S-X1
	⊕	M22-XDP-S-X4
⊖	M22-XDP-S-X5	
⓪	M22-XDP-S-X7	
Red	—	M22-XDP-R ②
	Custom	M22-XDP-R-ETCH ③
	STOP	M22-XDP-R-GB0
	OFF	M22-XDP-R-GB5
	⊙	M22-XDP-R-X0
Green	—	M22-XDP-G ②
	Custom	M22-XDP-G-ETCH ③
	START	M22-XDP-G-GB1
	ON	M22-XDP-G-GB6
	⊙	M22-XDP-G-X0
White	—	M22-XDP-W ②
	Custom	M22-XDP-W-ETCH ③
Yellow	—	M22-XDP-Y ②
	Custom	M22-XDP-Y-ETCH ③

M22-DP-G-X



Momentary Insertless Mushroom Head Operators

Bezel	Color	Catalog Number
Silver	Black	M22-DP-S-X
	Red	M22-DP-R-X
	Green	M22-DP-G-X
	Yellow	M22-DP-Y-X
Black	Black	M22S-DP-S-X
	Red	M22S-DP-R-X
	Green	M22S-DP-G-X
	Yellow	M22S-DP-Y-X

M22-DRP-G-X



Maintained Insertless Mushroom Head Operators ④

Bezel	Color	Catalog Number
Silver	Black	M22-DRP-S-X
	Red	M22-DRP-R-X
	Green	M22-DRP-G-X
	Yellow	M22-DRP-Y-X
Black	Black	M22S-DRP-S-X
	Red	M22S-DRP-R-X
	Green	M22S-DRP-G-X
	Yellow	M22S-DRP-Y-X

Notes

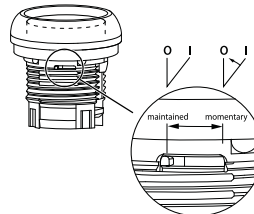

- ① 35 mm diameter mushroom head button.
- ② Minimum order quantity of (10).
- ③ When ordering, specify inscription per catalog number suffix from the Symbols Library (see Volume 7—Logic Control, Operator Interface and Connectivity Solutions, CA08100008E, Tab 1) into the Order Notes.
For example, M22-XDP-S-ETCH; Order Notes: Mark with symbol X91, Line item #_.
- ④ Maintained pushbuttons can be converted in the field to momentary operation by switching the locking ring, which is accessible through the side of the operator body.



Components

Double Pushbuttons, Extended Pushbuttons and Center Light, Momentary

Operators Only ^①



	Bezel	Color		Inscription		Catalog Number
		Top	Bottom	Top	Bottom	
 <p>M22-DDL-GR-GB1-GB0</p>	Silver	Green	Red	—	—	M22-DDL-GR
				Custom	Custom	M22-DDL-GR-ETCH ^②
				①	Ⓢ	M22-DDL-GR-X1-X0
				START	STOP	M22-DDL-GR-GB1-GB0
		White	Black	—	—	M22-DDL-WS
				Custom	Custom	M22-DDL-WS-ETCH ^②
				①	Ⓢ	M22-DDL-WS-X1-X0
				START	STOP	M22-DDL-WS-GB1-GB0
		Black	Black	—	—	M22-DDL-S
				Custom	Custom	M22-DDL-S-ETCH ^②
				—	—	M22-DDL-S-X4-X5
				①	①	M22-DDL-S-X7-X7
 <p>M22S-DDL-GR-X1-X0</p>	Black	Green	Red	—	—	M22S-DDL-GR
				Custom	Custom	M22S-DDL-GR-ETCH ^②
				①	Ⓢ	M22S-DDL-GR-X1-X0
				START	STOP	M22S-DDL-GR-GB1-GB0
		White	Black	—	—	M22S-DDL-WS
				Custom	Custom	M22S-DDL-WS-ETCH ^②
				①	Ⓢ	M22S-DDL-WS-X1-X0
				START	STOP	M22S-DDL-WS-GB1-GB0
		Black	Black	—	—	M22S-DDL-S
				Custom	Custom	M22S-DDL-S-ETCH ^②
				+	—	M22S-DDL-S-X4-X5
				①	①	M22S-DDL-S-X7-X7

Notes

- ① Includes contact block mounting adapter.
- ② When ordering, specify inscription per catalog number suffix from the Symbols Library (see Volume 7—Logic Control, Operator Interface and Connectivity Solutions, CA08100008E, Tab 1) into the Order Notes. For example, M22-DDL-S-ETCH; Order Notes: Mark with symbol X91, Line item #_.



Double Pushbuttons, Flush Top Pushbuttons and Center Light, Momentary

Operators Only ^①

	Bezel	Color Top	Bottom	Inscription Top	Bottom	Catalog Number
M22-DDLF-GR 	Silver	Green	Red	—	—	M22-DDLF-GR
		White	Black	—	—	M22-DDLF-GR-ETCH ^②
		Green	Red	⓪	⓪	M22-DDLF-GR-X1-X0
		White	Black	⓪	⓪	M22-DDLF-GR-X1-X0
		Custom	Custom	—	—	M22-DDLF-WS
M22S-DDLF-GR-X1-X0 	Black	Green	Red	—	—	M22S-DDLF-GR
		White	Black	—	—	M22S-DDLF-GR-ETCH ^②
		Green	Red	⓪	⓪	M22S-DDLF-GR-X1-X0
		White	Black	⓪	⓪	M22S-DDLF-GR-X1-X0
		Custom	Custom	—	—	M22S-DDLF-WS
				Custom	Custom	M22S-DDLF-WS-ETCH ^②

Double Pushbuttons, Flush Top Pushbutton and Center Light, Extended Bottom Pushbutton, Momentary

Operators Only ^①

	Bezel	Color Top	Bottom	Inscription Top	Bottom	Catalog Number
M22-DDLM-GR 	Silver	Green	Red	—	—	M22-DDLM-GR
		White	Black	—	—	M22-DDLM-GR-ETCH ^②
		Green	Red	⓪	⓪	M22-DDLM-GR-X1-X0
		White	Black	⓪	⓪	M22-DDLM-GR-X1-X0
		Custom	Custom	—	—	M22-DDLM-WS
M22S-DDLM-GR-X1-X0 	Black	Green	Red	—	—	M22S-DDLM-GR
		White	Black	—	—	M22S-DDLM-GR-ETCH ^②
		Green	Red	⓪	⓪	M22S-DDLM-GR-X1-X0
		White	Black	⓪	⓪	M22S-DDLM-GR-X1-X0
		Custom	Custom	—	—	M22S-DDLM-WS
				Custom	Custom	M22S-DDLM-WS-ETCH ^②

Notes

^① Includes contact block mounting adapter.

^② When ordering, specify inscription per catalog number suffix from the Symbols Library (see Volume 7—Logic Control, Operator Interface and Connectivity Solutions, CA08100008E, Tab 1) into the Order Notes. For example, M22-DDLM-GR-ETCH; Order Notes: Mark with symbol X91, Line item #_.

Four-Way Pushbuttons, Momentary

Components

M22-D4-S-X7



Operators Only ^①

Type	Bezel	Color	Inscription	Catalog Number
Non-interlocked	Silver	Black	—	M22-D4-S
			Custom	M22-D4-S-ETCH ^②
			Directional arrows	M22-D4-S-X7
	Black	Black	—	M22S-D4-S
			Custom	M22S-D4-S-ETCH ^②
			Directional arrows	M22S-D4-S-X7
Interlocked	Silver	Black	—	M22-DI4-S
			Custom	M22-DI4-S-ETCH ^②
			Directional arrows	M22-DI4-S-X7
	Black	Black	—	M22S-DI4-S
			Custom	M22S-DI4-S-ETCH ^②
			Directional arrows	M22S-DI4-S-X7

Joysticks

Components

M22-WJ2H



Operators Only ^①

Bezel	Number of Directions	Switching Position	Catalog Number	
Silver	Two-position horizontal	Momentary	M22-WJ2H	
		Two switch points	M22-WJ2H-2P	
	Two-position horizontal	Maintained	M22-WRJ2H	
		Two-position vertical	Momentary	M22-WJ2V
	Two switch points		M22-WJ2V-2P	
	Two-position vertical	Maintained	M22-WRJ2V	
		Four-position	Momentary	M22-WJ4
	Two switch points		M22-WJ4-2P	
	Four-position	Maintained	M22-WRJ4	
		Black	Two-position horizontal	Momentary
	Two switch points			M22S-WJ2H-2P
	Two-position horizontal		Maintained	M22S-WRJ2H
Two-position vertical			Momentary	M22S-WJ2V
	Two switch points		M22S-WJ2V-2P	
Two-position vertical	Maintained		M22S-WRJ2V	
	Four-position		Momentary	M22S-WJ4
Two switch points			M22S-WJ4-2P	
Four-position	Maintained		M22S-WRJ4	

Notes

- ^① Includes contact block mounting adapter.
- ^② When ordering, specify inscription per catalog number suffix from the Symbols Library (see Volume 7—Logic Control, Operator Interface and Connectivity Solutions, CA08100008E, Tab 1) into the Order Notes. For example, M22-DDLM-GR-ETCH; Order Notes: Mark with symbol X91, Line item #_

Potentiometers

M22-R10K



Complete Devices

Bezel	Resistance Rk	Catalog Number
Silver	1	M22-R1K
	4.7	M22-R4K7
	10	M22-R10K
	47	M22-R47K
	100	M22-R100K
	470	M22-R470K
Black	1	M22S-R1K
	4.7	M22S-R4K7
	10	M22S-R10K
	47	M22S-R47K
	100	M22S-R100K
	470	M22S-R470K
Oversized Knob		
Silver	1	M22-R1K-RH
	4.7	M22-R4K7-RH
	10	M22-R10K-RH
	47	M22-R47K-RH
	100	M22-R100K-RH
	470	M22-R470K-RH
Black	1	M22S-R1K-RH
	4.7	M22S-R4K7-RH
	10	M22S-R10K-RH
	47	M22S-R47K-RH
	100	M22S-R100K-RH
	470	M22S-R470K-RH

Acoustic Devices

M22-AMC-XAM



Complete Devices

Description	Decibel Rating	Catalog Number
Indicator with buzzer, black continuous tone, 18–30 Vac/Vdc	83 dB/ 10 cm	M22-AMC-XAM
Indicator with buzzer, black pulsed tone, 18–30 Vac/Vdc	83 dB/ 10 cm	M22-AMC-XAMP

M22-XAM



Components

Description	Decibel Rating	Catalog Number
Indicator without buzzer, black	83 dB/ 10 cm	M22-AMC
Buzzer only, continuous tone, 18–30 Vac/Vdc	83 dB/ 10 cm	M22-XAM
Buzzer only, pulsed tone, 18–30 Vac/Vdc	83 dB/ 10 cm	M22-XAMP

Through-the-Door Operators ^①

M22-DZ-B-X6

Complete Devices



Color	Inscription	Catalog Number
Blue	—	M22-DZ-B
	RESET	M22-DZ-B-GB14
	Ⓡ	M22-DZ-B-X6
Red	—	M22-DZ-R
	Ⓢ	M22-DZ-R-X0
	STOP	M22-DZ-R-GB0

M22-DZ-X

Buttonless Operator



Bezel	Catalog Number
Silver	M22-DZ-X

M22-XD-B

Button Plates ^②

Color	Inscription	Catalog Number
Blue	—	M22-XD-B ^③
	RESET	M22-XD-B-GB14
	Ⓡ	M22-XD-B-X6
Red	—	M22-XD-R ^③
	Ⓢ	M22-XD-R-X0
	STOP	M22-XD-R-GB0

Bulkhead Interfaces

M22-USB-SA

USB Socket ^{④⑤}

Description	Catalog Number
Used for USB connection USB 2.0 Type A plug IP65 when closed IP20 when connected	M22-USB-SA

M22-RJ45-SA

RJ45 Socket ^⑥

Description	Catalog Number
Used for RJ45 Ethernet connection IP65 when closed IP20 when connected	M22-RJ45-SA

Notes

- ① The pushrod is 3.24 in long and can be cut to length.
- ② Any combination of plate color and inscription is available.
- ③ Minimum order quantity of (10).
- ④ USB interface is complete with 2-ft-long USB cable.
- ⑤ UL and CSA pending.
- ⑥ RJ45 interface is an eight-wire connector.

ASi Adapter Modules

M22-ASI



Complete Devices

Description	Catalog Number
ASi adapter module	M22-ASI
ASi adapter module for base mounting	M22-ASI-C
ASi adapter module for E-stop	M22-ASI-S
ASi adapter module for E-stop base mounting	M22-ASI-CS

4

Complete Devices

Operator, Base and Contact Blocks ^①

FAK-S-KC11-I



Button Color	Contact Block Configuration ^②	Catalog Number
Momentary		
Black	1NO-1NC	FAK-S-KC11-I
Red	1NO-1NC	FAK-R-KC11-I
Yellow	1NO-1NC	FAK-Y-KC11-I

FAK-R-V-KC01-IY



Button Color	Contact Block Configuration ^②	Catalog Number
Maintained		
Red	NC	FAK-R-V-KC01-IY
	2NC	FAK-R-V-KC02-IY
	1NO-2NC	FAK-R-V-KC12-IY
	1NO-1NC	FAK-R-V-KC11-IY



Notes

^① For complete listing of available contact blocks, see Accessories, Pages V9-T4-31 to V9-T4-36.

^② All NC contact blocks are positively driven contact. ⊖

Accessories

Mounting Adapters

	Description	Catalog Number
M22-A	Contact block mounting adapter. ①	M22-A
		
M22-A4	Contact block mounting adapter, four-position (for use with four-way pushbuttons, joysticks and four-position selector switches only). ①	M22-A4
		
M22-LS	Allows mounting of M22 pushbuttons to LS-Titan limit switch bodies (for the full LS-Titan catalog section, see PG08301004E). ①	M22-LS
		

Contact Blocks

Mounting Location	Terminal Type	Contact Configuration ②	Package Qty.	Catalog Number		
Front	Screw	NO	1	M22-K10		
		NO	25	M22-K10-B25		
		NO	100	M22-K10-B100		
		NO, early-make	1	M22-K10P		
		NC	1	M22-K01		
		NC	25	M22-K01-B25		
		NC	100	M22-K01-B100		
		NC, late-break	1	M22-K01D		
		Base		NO	1	M22-KC10
NO	25			M22-KC10-B25		
NO	100			M22-KC10-B100		
NC	1			M22-KC01		
NC	25			M22-KC01-B25		
NC	100			M22-KC01-B100		
Front	Spring cage			NO	1	M22-CK10
				NC	1	M22-CK01
				NC, late-break	1	M22-CK01D
		2NO ③	1	M22-CK20		
		2NC ③	1	M22-CK02		
		NO-NC ③	1	M22-CK11		
		Base		NO	1	M22-CKC10
NC	1			M22-CKC01		

Notes

- ① Included with each operator.
 ② All NC contact blocks are positively driven contact. ⊖
 ③ Not stackable.

M22-LED-W



Light Units

Terminal Type	Mounting Location	LED Color	Light Unit Voltage	Catalog Number	
Screw	Front	White	12–30 Vac/Vdc	M22-LED-W	
		Red		M22-LED-R	
		Green		M22-LED-G	
		Blue		M22-LED-B	
		White	85–264 Vac	M22-LED230-W	
		Red		M22-LED230-R	
		Green		M22-LED230-G	
		Blue		M22-LED230-B	
		White	207–264 Vac	M22-LED230H-W	
		Red		M22-LED230H-R	
		Green		M22-LED230H-G	
		Blue		M22-LED230H-B	
	Base	White	12–30 Vac/Vdc	M22-LEDC-W	
		Red		M22-LEDC-R	
		Green		M22-LEDC-G	
		Blue		M22-LEDC-B	
		White	85–264 Vac	M22-LEDC230-W	
		Red		M22-LEDC230-R	
		Green		M22-LEDC230-G	
		Blue		M22-LEDC230-B	
		White	207–264 Vac	M22-LEDC230H-W	
		Red		M22-LEDC230H-R	
		Green		M22-LEDC230H-G	
		Blue		M22-LEDC230H-B	
Spring cage	Front	White	12–30 Vac/Vdc	M22-CLED-W	
		Red		M22-CLED-R	
		Green		M22-CLED-G	
		Blue		M22-CLED-B	
		White	85–264 Vac	M22-CLED230-W	
		Red		M22-CLED230-R	
		Green		M22-CLED230-G	
		Blue		M22-CLED230-B	
		Base	White	12–30 Vac/Vdc	M22-CLEDC-W
			Red		M22-CLEDC-R
			Green		M22-CLEDC-G
			Blue		M22-CLEDC-B
	White		85–264 Vac	M22-CLEDC230-W	
	Red			M22-CLEDC230-R	
	Green			M22-CLEDC230-G	
	Blue			M22-CLEDC230-B	

M22-XLED60**LED Resistor and Test Elements**

Terminal Type	Mounting Location	Element Type	Voltage	Catalog Number
Screw	Front	Resistor ①②	42–60 Vac/Vdc	M22-XLED60
			220 Vdc	M22-XLED220
		Test	12–240 Vac/Vdc	M22-XLED-T
			85–264 Vac	M22-XLED230-T

Legend Plate Holders and Inserts, Pushbuttons and Double Pushbuttons ③**M22S-ST-X**

Description	Inscription	Catalog Number
Legend plate holder, without legend plate insert, for pushbuttons	—	M22S-ST-X
Legend plate holder, without legend plate insert, for double pushbuttons	—	M22S-STDD-X

M22-XST-GB0

Legend plate insert	—	M22-XST
	Custom	M22-XST-ETCH ④
	STOP	M22-XST-GB0
	START	M22-XST-GB1
	OFF	M22-XST-GB5
	ON	M22-XST-GB6
	RUN	M22-XST-GB7
	FAULT	M22-XST-GB8
	OFF ON	M22-XST-GB10
	MAN. AUTO	M22-XST-GB11
	MAN. O AUTO	M22-XST-GB12
	HAND AUTO	M22-XST-D11
	HAND O AUTO	M22-XST-D12
	1	M22-XST-X52
2	M22-XST-X53	
0 I	M22-XST-X88	
0 - I	M22-XST-X89	
I O II	M22-XST-X93	

Notes







- ① Resistor units to be used with 12–30V light units.
- ② Refer to **IL04716002E** for use of resistor elements in series for higher DC voltage.
- ③ Legend plates are IP66 and NEMA 4X/13.
- ④ When ordering, specify inscription per catalog number suffix from the Symbols Library (see Volume 7—Logic Control, Operator Interface and Connectivity Solutions, CA08100008E, Tab 1) into the Order Notes. For example, M22-XD-S-ETCH; Order Notes: Mark with symbol X91, Line item #__.

Example

To order a legend plate for a pushbutton with non-standard markings (FORWARD):

1. Select legend plate holder—M22S-ST-X.
2. Select legend plate insert—M22-XST-ETCH.
3. Select FORWARD from the Symbols Library, Volume 7—Logic Control, Operator Interface and Connectivity Solutions, CA08100008E, Tab 1, identified by GB15 suffix.
4. Indicate on the order form in the order notes—suffix GB15, line item # __ .

Legend Plates, Complete ①



	Description	Inscription	Catalog Number
M22S-ST-GB0 	For use with pushbuttons and indicating lights	Legend plate holder with insert	M22S-ST-GB0
		STOP	M22S-ST-GB1
		START	M22S-ST-GB5
		OFF	M22S-ST-GB6
		ON	M22S-ST-GB7
		RUN	M22S-ST-GB8
		FAULT	M22S-ST-X52
		1	M22S-ST-X53
		2	M22S-ST-GB10
		OFF ON	M22S-ST-GB11
		MAN. AUTO	M22S-ST-GB12
		MAN. O AUTO	M22S-ST-D11
HAND AUTO	M22S-ST-D12		
HAND O AUTO	M22S-ST-X88		
O I	M22S-ST-X89		
O - I	M22S-ST-X93		
I O II	M22-XZK		
M22-XZK 	Emergency-stop operators	Rectangular yellow legend plate	M22-XZK
		Custom	M22-XZK-ETCH ②
		EMERGENCY-STOP	M22-XZK-GB99
M22-XYK 	Emergency-stop operators	Square yellow legend plate	M22-XYK
		Custom	M22-XYK-ETCH ②
		EMERGENCY-STOP four-language	M22-XYK1
		EMERGENCY-STOP (top and bottom)	M22-XYK5
		Round yellow legend plate, 90 mm	M22-XAK
M22-XBK1 	Emergency-stop operators	Round yellow legend plate, 90 mm	M22-XAK
		Custom	M22-XAK-ETCH ②
		EMERGENCY-STOP four-language	M22-XAK1
		EMERGENCY-STOP (top and bottom)	M22-XAK5
		Round yellow legend plate, 60 mm	M22-XBK
M22-XBK1 	Emergency-stop operators	Round yellow legend plate, 60 mm	M22-XBK
		Custom	M22-XBK-ETCH ②
		EMERGENCY-STOP four-language	M22-XBK1
		EMERGENCY-STOP (top and bottom)	M22-XBK5
		M22-XCK1 	Four-way pushbutton, joystick and four-position selector switches
Custom	M22-XCK-ETCH ②		
Four directional arrows	M22-XCK1		
0-1-0-2-0-3-0-4	M22-XCK2		
Two directional arrows	M22-XCK3		

Notes

① Legend plates are IP66 and NEMA 4X/13.

② When ordering, specify inscription per catalog number suffix from the Symbols Library (see Volume 7—Logic Control, Operator Interface and Connectivity Solutions, CA08100008E, Tab 1) into the Order Notes. For example, M22-XD-S-ETCH; Order Notes: Mark with symbol X91, Line item #_.

Surface Mounting Enclosures ①

	Description	Catalog Number
	Yellow top, black base for emergency-stop operators	M22-IY1-PG
	One-element enclosure	M22-I1-PG
	Two-element enclosure	M22-I2-PG
	Three-element enclosure	M22-I3-PG
	Four-element enclosure	M22-I4-PG
	Six-element enclosure	M22-I6-PG
	M20 connecting screw	M22-XI
	M20 cord grip	V-M20





M22-EY1**Flush Mounting Plates, Aluminum**

Finish	Rating	Catalog Number
One Hole		
Yellow paint for emergency-stop operators	—	M22-EY1
Gray anodized	IP65	M22-E1
Two Holes		
Gray anodized	IP65	M22-E2
Three Holes		
Gray anodized	IP65	M22-E3
Four Holes		
Gray anodized	IP65	M22-E4
Five Holes		
Gray anodized	IP65	M22-E5
Six Holes		
Anodized	IP40	M22-E6



M22-H1**Shrouds, Plastic**

Description	Rating	Catalog Number
One-element	IP55	M22-H1
Two-element	IP55	M22-H2
Three-element	IP55	M22-H3
Four-element	IP40	M22-H4
Five-element	IP40	M22-H5
Six-element	IP40	M22-H6
Mounting plate	—	M22-XE5
Plaster keys for flush mounting	—	M22-UPE

Selector Switch Accessories

	Description	Catalog Number
	Plunger bridge ②	M22-XW
	Key cover	M22-XWS
	Key withdraw adapter ③	M22-XC-R
	Coding adapter	M22-XC-Y
	Guard ring	M22-XGWK

Emergency Stop Operator Accessories

Description	Catalog Number
 Yellow guard ring	M22-XGVP
 Gray guard ring	M22G-XGPV
 Sealing shroud	M22-PL-PV

Blanking Plugs

Color	Catalog Number
Gray	M22-B
Black	M22S-B

Notes

- ① Requires use of base mounted contact blocks.
- ② Plunger needed to actuate center-mounted contact blocks. Used for non-illuminated three-position selector switches only.
- ③ Enables a keyed selector switch to be set to user-selected key withdraw position.

4.1

Operator Interface

Pushbutton and Pilot Devices

4

Mounting Accessories

	Description	Catalog Number
	Telescopic clip with top-hat rail	M22-TC
	Telescopic clip	M22-TA
	Telescopic clip extension	M22-TCV
	DIN rail mounting adapter	M22-IVS
	Mounting ring	M22-GR
	Mounting ring tool	M22-MS
	Adapter ring set for 30 mm holes	M22S-R30

M22-T-D and M22-T-DD



Protective Diaphragm

For Use with ...	Catalog Number
Flush pushbuttons and indicating lights	M22-T-D
Double pushbuttons	M22-T-DD

M22-ADC4



Dust Covers

Description	Catalog Number
Contact block dust cover	M22-XKDP
Operator dust cover, max three contact blocks	M22-ADC
Operator dust cover, max four contact blocks	M22-ADC4

Kits

Description	Catalog Number
Includes one each: M22-XW, M22-XC-R, M22-XC-Y, M22S-B, M22-A, M22-XD-SWRGYB	M22-KT1

10250T—30 mm Pushbuttons



Features

- Heavy-duty zinc die-cast construction
- Enclosed silver contacts with reliability nibs
- Diaphragm seals with drainage holes
- Grounding nibs on the operator casing

Product Selection

10250T—30 mm Pushbuttons

Flush Button



Extended Button



Mushroom Button



Jumbo Mushroom



Non-Illuminated Pushbutton Units—UL (NEMA) Type 3, 3R, 4, 4X, 12, 13

Contact Type	Button Color	Catalog Number			
		Flush Button	Extended Button	Mushroom Button	Jumbo Mushroom ①
1NO	Black	10250T23B	10250T25B	10250T26B	10250T27B
	Red	10250T23R	10250T112-53	10250T122-53	10250T172-53
	Green	10250T23G	10250T25G	10250T26G	10250T27G
	Yellow	10250T23Y	10250T25Y	10250T26Y	10250T27Y
	Red—Engraved EMERG. STOP	—	—	—	10250T17213-53
1NC	Black	10250T101-51	10250T111-51	10250T121-51	10250T171-51
	Red	10250T102-51	10250T25R	10250T26R	10250T27R
	Green	10250T103-51	10250T113-51	10250T123-51	10250T173-51
	Yellow	10250T104-51	10250T120-51	10250T124-51	10250T174-51
	Red—Engraved EMERG. STOP	—	—	—	10250T29
1NO-1NC	Black	10250T30B	10250T31B	10250T32B	10250T33B
	Red	10250T30R	10250T31R	10250T32R	10250T33R
	Green	10250T30G	10250T31G	10250T32G	10250T33G
	Yellow	10250T30Y	10250T31Y	10250T32Y	10250T33Y
	Red—Engraved EMERG. STOP	—	—	—	10250T33
2NO	Black	10250T101-2	10250T111-2	10250T121-2	10250T171-2
	Red	10250T102-2	10250T112-2	10250T122-2	10250T172-2
	Green	10250T103-2	10250T113-2	10250T123-2	10250T173-2
	Yellow	10250T104-2	10250T120-2	10250T124-2	10250T174-2
	Red—Engraved EMERG. STOP	—	—	—	10250T17213-2
2NC	Black	10250T101-3	10250T111-3	10250T121-3	10250T171-3
	Red	10250T102-3	10250T112-3	10250T122-3	10250T172-3
	Green	10250T103-3	10250T113-3	10250T123-3	10250T173-3
	Yellow	10250T104-3	10250T120-3	10250T124-3	10250T174-3
	Red—Engraved EMERG. STOP	—	—	—	10250T17213-3

Note

① Anodized aluminum head is not suitable for use in ultraviolet light applications.

24V Full Voltage Illuminated Pushbutton



Illuminated Pushbutton Units—UL (NEMA) Type 3, 3R, 4, 4X, 12, 13

Type	Voltage	Color	LED/Lamp Number	Catalog Number			
				Illuminated Pushbutton 1N0	1N0-1NC	1NC	
LED Lamp							
Full voltage	24 Vac/Vdc	Red	Bayonet base	10250T397LRD24-53	10250T397LRD24-1	10250T397LRD24-51	
		Green		10250T397LGD24-53	10250T397LGD24-1	10250T397LGD24-51	
		Amber		10250T397LAD24-53	10250T397LAD24-1	10250T397LAD24-51	
		Yellow		10250T397LYD24-53	10250T397LYD24-1	10250T397LYD24-51	
		Blue		10250T397LLD24-53	10250T397LLD24-1	10250T397LLD24-51	
		White		10250T397LWD24-53	10250T397LWD24-1	10250T397LWD24-51	
		120 Vac		Red	10250T397LRD2A-53	10250T397LRD2A-1	10250T397LRD2A-51
	Green		10250T397LGD2A-53	10250T397LGD2A-1	10250T397LGD2A-51		
	Amber		10250T397LAD2A-53	10250T397LAD2A-1	10250T397LAD2A-51		
	Yellow		10250T397LYD2A-53	10250T397LYD2A-2	10250T397LYD2A-51		
	Blue		10250T397LLD2A-53	10250T397LLD2A-1	10250T397LLD2A-51		
	White		10250T397LWD2A-53	10250T397LWD2A-1	10250T397LWD2A-51		
	Transformer	120 Vac	Red		10250T411LRD06-53	10250T411LRD06-1	10250T411LRD06-51
			Green		10250T411LGD06-53	10250T411LGD06-1	10250T411LGD06-51
			Amber		10250T411LAD06-53	10250T411LAD06-1	10250T411LAD06-51
			Yellow		10250T411LYD06-53	10250T411LYD06-1	10250T411LYD06-51
			Blue		10250T411LLD06-53	10250T411LLD06-1	10250T411LLD06-51
			White		10250T411LWD06-53	10250T411LWD06-1	10250T411LWD06-51
			Incandescent Lamp				
	Full voltage	24 Vac/Vdc	Red	#757	10250T476C21-53	10250T476C21-1	10250T476C21-51
			Green		10250T476C22-53	10250T476C22-1	10250T476C22-51
Amber			10250T476C43-53		10250T476C43-1	10250T476C43-51	
Yellow			10250T476C23-53		10250T476C23-1	10250T476C23-51	
Blue			10250T476C24-53		10250T476C24-1	10250T476C24-51	
Clear			10250T476C25-53		10250T476C25-1	10250T476C25-51	
White			10250T476C26-53		10250T476C26-1	10250T476C26-51	
Resistor		120 Vac/Vdc	Red	120MB	10250T471C21-53	10250T471C21-1	10250T471C21-51
			Green		10250T471C22-53	10250T471C22-1	10250T471C22-51
			Amber		10250T471C43-53	10250T471C43-1	10250T471C43-51
			Yellow		10250T471C23-53	10250T471C23-1	10250T471C23-51
			Blue		10250T471C24-53	10250T471C24-1	10250T471C24-51
			Clear		10250T471C25-53	10250T471C25-1	10250T471C25-51
			White		10250T471C26-53	10250T471C26-1	10250T471C26-51
Transformer	120 Vac	Red	#755	10250T75R ①	10250T76R ①	10250T77R ①	
		Green		10250T75G ①	10250T76G ①	10250T77G ①	
		Amber		10250T75A ①	10250T76A ①	10250T77A ①	
		Yellow		10250T75Y ①	10250T76Y ①	10250T77Y ①	
		Blue		10250T75B ①	10250T76B ①	10250T77B ①	
		Clear		10250T75C ①	10250T76C ①	10250T77C ①	
		White		10250T75W ①	10250T76W ①	10250T77W ①	

Note

① For flashing module catalog number 10250TFL1, add suffix code **FM** to listed catalog number. Example: 10250T75RFM.

Indicating Light Units

24V Full Voltage Illuminated Light



120 Vac Transformer Pres Test



Indicating Light Units—UL (NEMA) Type 3, 3R, 4, 4X, 12, 13 ①

Type	Voltage	Color	LED/Lamp Number	Catalog Number 24V Full Voltage Indicating Light—Red Catalog Number 10250T206NC1N	Catalog Number 120V AC Transformer Pres Test—Green Catalog Number 10250T74NG										
LED Lamp															
Full voltage	24 Vac/Vdc	Red	Bayonet base	10250T197LRP24	10250T297LRP24										
				10250T197LGP24	10250T297LGP24										
				10250T197LAP24	10250T297LAP24										
				10250T197LYP24	10250T297LYP24										
				10250T197LLP24	10250T297LLP24										
				10250T197LWP24	10250T297LWP24										
		120 Vac	Red	10250T197LRP2A	10250T297LRP2A										
				10250T197LGP2A	10250T297LGP2A										
				10250T197LAP2A	10250T297LAP2A										
				10250T197LYP2A	10250T297LYP2A										
				10250T197LLP2A	10250T297LLP2A										
				10250T197LWP2A	10250T297LWP2A										
				Green	Amber	Yellow	Blue	White	10250T181LRP06	10250T221LRP06					
											10250T181LGP06	10250T221LGP06			
											10250T181LAP06	10250T221LAP06			
											10250T181LYP06	10250T221LYP06			
											10250T181LLP06	10250T221LLP06			
											10250T181LWP06	10250T221LWP06			
Transformer	120 VAC	Red	120MB	10250T206NC1N	10250T235NC21										
				10250T206NC2N	10250T235NC22										
				10250T206NC19N	10250T235NC43										
				10250T206NC3N	10250T235NC23										
				10250T206NC4N	10250T235NC24										
				10250T206NC5N	10250T235NC25										
		Green	Amber	Yellow	Blue	Clear	White	10250T201NC1N	10250T231NC21						
										10250T201NC2N	10250T231NC22				
										10250T201NC19N	10250T231NC43				
										10250T201NC3N	10250T231NC23				
										10250T201NC4N	10250T231NC24				
										10250T201NC5N	10250T231NC25				
										10250T201NC6N	10250T231NC26				
										Resistor	120 Vac/Vdc	Red	#757	10250T34R	10250T74NR
														10250T34G	10250T74NG
														10250T34A	10250T74NA
														10250T34Y	10250T74NY
														10250T34B	10250T74NB
10250T34C	10250T74NC														
10250T34W	10250T74NW														
Transformer ②	120 VAC	Green	#755	10250T206NC6N	10250T235NC26										
				10250T206NC5N	10250T235NC25										
				10250T206NC4N	10250T235NC24										
				10250T206NC3N	10250T235NC23										
				10250T206NC19N	10250T235NC43										
				10250T206NC2N	10250T235NC22										
				10250T206NC1N	10250T235NC21										

Notes

- ① Standard indicating lights are rated UL (NEMA) 3S as well.
- ② For flashing lamp, add letter **F** to listed catalog number. Example: 10250T34RF.

4.1













Operator Interface

Pushbutton and Pilot Devices

4

Two-Position Push-Pull Units—UL (NEMA) Type 3, 3R, 4, 4X, 12, 13







Operator Position ①

	Operator Position ①		Button Type/Color	Contact Type	Mounting Location		Catalog Number
	Pull	Push			A	B	
Two-Position Maintained Push, Maintained Pull							
10250T5B62-1X 	0	X	40 mm/red	1NO			10250T5B62-1X
	X	0		1NC			
10250T5B63-1X 	0	X	40 mm engraved EMERG. STOP/red	1NO			10250T5B63-1X
	X	0		1NC			
10250T5J63-1X 	0	X	65 mm aluminum engraved EMERG. STOP/red	1NO			10250T5J63-1X
	X	0		1NC			
10250ED1080-2 	0	X	65 mm aluminum engraved EMERG. STOP/red Special security jumbo mushroom head	1NO			10250ED1080-2
	X	0		1NC			

Three-Position Push-Pull Units—UL (NEMA) Type 3, 3R, 4, 4X, 12, 13

Operator Position ①



	Operator Position ①			Button Type/Color	Contact Type	Mounting Location		Catalog Number
	Pull	Intermediate	Push			A	B	
Three-Position Maintained Push, Momentary Pull								
X	0	0	40 mm/black	1NC			10250T9B60-3X	
	X	X	40 mm/red	1NC				10250T9B62-3X
	X	X	40 mm engraved EMERG. STOP/red					10250T9B63-3X
Three-Position Momentary Push, Momentary Pull								
X	0	0	40 mm/black	1NC			10250T4B60-3X	
	X	X	40 mm/red	1NC				10250T4B62-3X
0	0	X	40 mm/black	1NO			10250T10B60-1X	
	X	0	40 mm/red	1NC				10250T10B62-1X

Note

① X = closed circuit, 0 = open circuit.

Two-Position Push-Pull Operator



Two-Position Illuminated Maintained Push, Maintained Pull—UL (NEMA) Type 3, 3R, 4, 4X, 12, 13

Operator Position ①

Maintained—Pull	Maintained—Push	Lamp	Type	Voltage	Contact Type	Mounting Location A B	LED/Lamp Number	Red Standard Push-Pull Catalog Number
0 X	X 0	LED	Full Voltage	24 Vac/Vdc 120 Vac/Vdc	1NO 1NC		Bayonet base	10250T597LRD24-1X 10250T597LRD2A-1X 10250T589LRD06-1X 10250T563LRD06-1X
			Transformer	24 Vac 120 Vac				
0 X	X 0	Incandescent	Full voltage	24 Vac/Vdc 120 Vac/Vdc	1NO 1NC		#757 120MB	10250T579C47-1X 10250T580C47-1X 10250T589C47-1X 10250T563C47-1X
			Transformer	24 Vac 120 Vac			#755	

Three-Position Push-Pull Operator



Three-Position Illuminated Momentary Push, Momentary Pull—UL (NEMA) Type 3, 3R, 4, 4X, 12, 13

Operator Position ①

Momentary—Pull	Maintained—Intermediate	Momentary—Push	Lamp	Type	Voltage	Contact Type	Mounting Location A B	LED/Lamp Number	Red Standard Push-Pull Catalog Number
0 X	0 0	X 0	LED	Full voltage	24 Vac/Vdc 120 Vac	1NO 1NC		Bayonet base	10250T1097LRD24-1X 10250T1097LRD2A-1X 10250T1089LRD06-1X 10250T1063LRD06-1X
				Transformer	24 Vac 120 Vac				
X X	0 X	0 0		Full voltage	24 Vac/Vdc 120 Vac	1NC 1NC		Bayonet base	10250T497LRD24-3X 10250T497LRD2A-3X 10250T489LRD06-3X 10250T463LRD06-3X
				Transformer	24 Vac 120 Vac				
0 X	0 0	X 0	Incandescent	Full voltage	24 Vac/Vdc 120 Vac	1NO 1NC		#757 120MB	10250T1079C47-1X 10250T1080C47-1X 10250T1089C47-1X 10250T1063C47-1X
				Transformer	24 Vac 120 Vac			#755	
X X	0 X	0 0		Full voltage	24 Vac/Vdc 120 Vac	1NC 1NC		#757 120MB	10250T479C47-3X 10250T480C47-3X 10250T489C47-3X 10250T463C47-3X
				Transformer	24 Vac 120 Vac			#755	

Note

① X = closed circuit, 0 = open circuit.

4.1

Operator Interface

Pushbutton and Pilot Devices

Three-Position Push-Pull Operator



Three-Position Illuminated Maintained Push, Momentary Pull—UL (NEMA) Type 3, 3R, 4, 4X, 12, 13

Operator Position^①

Momentary— Pull	Maintained— Intermediate	Momentary— Push	Lamp	Type	Voltage	Contact Type	Mounting Location		LED/ Lamp Number	Red Standard Push-Pull Catalog Number
							A	B		
X	0	0	LED	Full voltage	24 Vac/Vdc	1NC	o o	Bayonet base	10250T997LRD24-3X	
X	X	0			120 Vac	1NC	o o		10250T997LRD2A-3X	
					Transformer	24 Vac			10250T989LRD06-3X	
					120 Vac				10250T963LRD06-3X	
X	0	0	Incan- descent	Full voltage	24 Vac/Vdc	1NC	o o	#757	10250T979C47-3X	
X	X	0			120 Vac	1NC	o o		10250T980C47-3X	
					Transformer	24 Vac			#755	10250T989C47-3X
					120 Vac				10250T963C47-3X	

4

Potentiometers

Vertical or Horizontal^② One-Hole Mounting

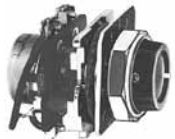

Potentiometer with Knob and Standard Dial Plate—Linear Type ±10%—UL (NEMA) Type 3, 3R, 4, 12, 13

Potentiometer Ohms	Catalog Number
2 Watt (60V Max.) Single Potentiometer with Standard Aluminum Dial Plate^{③④}	
1000	10250T331
2500	10250T332
5000	10250T338
10000	10250T333
25000	10250T334
50000	10250T335
Operator only ^⑤	10250T330
Alternative—black plastic large legend with standard markings	E34LP99

Notes

- ① X = closed circuit, 0 = open circuit.
- ② Shown with standard aluminum dial plate.
- ③ Large dial plate with space for legend is available at no charge. To order, add suffix **36** to catalog number. Example: 10250T331**36**. To order separately, see footnote ④ below.
- ④ Large dial plate has space at top for 15 letters. 3/32 in high. For custom stamped legend plates, order legend plate as separate item **10250TR30** and specify stamping.
- ⑤ For use with commercially purchased potentiometers having shaft dimensions per dimension drawing

Selector Switch Units

Two-Position Maintained Switch



Two-Position Selector Switch—UL (NEMA) Type 3, 3R, 4, 4X, 12, 13

Operator Position ①		Operator Action ②	Contact Type	Mounting Location		Non-Illuminated		Illuminated—120V Transformer	
X	O			A	B	Black Knob Catalog Number ③	Black Lever Catalog Number ③	Red Knob Catalog Number ③	Red Lever Catalog Number ③
X	O		1NC			<u>10250T20KB</u>	<u>10250T20LB</u>	<u>10250ED1117-KR</u>	<u>10250ED1117-LR</u>
O	X		1NO						

Three-Position Maintained Switch



Three-Position Selector Switch—UL (NEMA) Type 3, 3R, 4, 4X, 12, 13

Operator Position ①			Operator Action ②	Contact Type	Mounting Location		Non-Illuminated		Illuminated—120V Transformer	
X	O	O			A	B	Black Knob Catalog Number ③	Black Lever Catalog Number ③	Red Knob Catalog Number ③	Red Lever Catalog Number ③
X	O	O		1NO			<u>10250T21KB</u>	<u>10250T21LB</u>	<u>10250ED1117-2KR</u>	<u>10250ED1117-2LR</u>
O	O	X		1NO						
X	O	O		1NO			<u>10250T22KB</u>	<u>10250T22LB</u>	<u>10250ED1117-3KR</u>	<u>10250ED1117-3LR</u>
O	X	O		2NC (Series)						
O	O	X		1NO						

Four-Position Maintained Switch



Four-Position Selector Switch—UL (NEMA) Type 3, 3R, 4, 4X, 12, 13

Operator Position ①				Operator Action ②	Contact Type	Mounting Location		Non-Illuminated		Illuminated—120V Transformer	
X	O	O	O			A	B	Black Knob Catalog Number ③	Black Lever Catalog Number ③	Red Knob Catalog Number ③	Red Lever Catalog Number ③
X	O	O	O		1NC			<u>10250T46KB</u>	<u>10250T46LB</u>	<u>10250ED1117-4KR</u>	<u>10250ED1117-4LR</u>
O	X	O	O		1NO						
O	O	X	O		1NO						
O	O	O	X		1NC						

Color Selection

Illuminated						Non-Illuminated					
Color	Code Letter	Color	Code Letter	Color	Code Letter	Color	Code Letter	Color	Code Letter	Color	Code Letter
Red	R	White	W	Amber	A	Black	B	Green	G	Blue	L
Green	G	Blue	B	Clear	C	Red	R	White	W	Orange	O

Notes

① X = closed circuit, O = open circuit.

② M = Maintained.

③ To order different type or color selector switch, substitute the underlined character with appropriate suffix code from the Color Selection table. Example: 10250T20KG.

Legend Plates

Square Legend Plate



1/2 Round Legend Plate



4

For Pushbutton Operators and Indicating Lights—Standard

Legend	Color of Field	Square ^① Catalog Number	1/2 Round Catalog Number	Legend	Color of Field	Square ^① Catalog Number	1/2 Round Catalog Number
Blank—see table on Page V9-T4-46.							
Letters on Legend Plates Below are 3/16 in High							
CLAMP	Black	10250TS90	10250TM90	OFF	Red	10250TS24	10250TM24
CLOSE		10250TS73	10250TM11	ON	Black	10250TS25	10250TM25
DOWN		10250TS74	10250TM12	OPEN		10250TS26	10250TM26
EMERG. STOP	Red	10250TS13	10250TM13	OUT		10250TS27	10250TM27
FAST	Black	10250TS75	10250TM14	POWER ON		10250TS80	10250TM80
FASTER		10250TS87	10250TM87	RAISE		10250TS28	10250TM28
FEEDER ON		10250TS94	10250TM94	READY		10250TS86	10250TM86
FEEDER OFF		10250TS95	10250TM95	RESET		10250TS29	10250TM29
FORWARD		10250TS15	10250TM15	REVERSE		10250TS30	10250TM30
HIGH		10250TS16	10250TM16	RUN		10250TS31	10250TM31
IN		10250TS17	10250TM17	SAFE		10250TS85	10250TM85
INCH		10250TS18	10250TM18	SLOW		10250TS32	10250TM32
JOG		10250TS19	10250TM19	SLOWER		10250TS88	10250TM88
JOG FOR.		10250TS20	10250TM20	START		10250TS33	10250TM33
JOG REV.		10250TS21	10250TM21	STOP	Red	10250TS34	10250TM34
LOW		10250TS22	10250TM22	TEST	Black	10250TS83	10250TM83
LOWER		10250TS23	10250TM23	TRANSFER		10250TS93	10250TM93
LUBE-FAIL		10250TS92	10250TM92	TRIP		10250TS84	10250TM84
MOTOR RUN		10250TS81	10250TM81	UNCLAMP		10250TS91	10250TM91
MOTOR STOP		10250TS82	10250TM82	UP		10250TS35	10250TM35

Blank Plastic Legend Plates—Square

Color Lettering	Field	Standard Catalog Number	Jumbo ^② Catalog Number	Extra Large Catalog Number
Black	White or silver ^③	10250TSP76	10250TLP76	10250TEP76
White	Red or black ^③	10250TSP77	10250TLP77	10250TEP77

Notes

- ① Square legend plates have a satin aluminum field. Color is on lower portion.
- ② Cannot be used on cast enclosures except for top row. Suitable for most sheet metal enclosures.
- ③ If legend plate is to be engraved, specify field color required.

Square Legend Plate



1/2 Round Legend Plate



For Selector Switch and Roto-Push Operators—Standard Size

Legend	Color of Field	Square ^① Catalog Number	1/2 Round Catalog Number	Legend	Color of Field	Square ^① Catalog Number	1/2 Round Catalog Number
Blank—see table on Page V9-T4-46.							
Two-Position—5/32 in High Lettering				Three-Position—1/8 in High Lettering			
FOR. REV.	Black	10250TS38	10250TM38	AUTO OFF HAND	Black	10250TS49	10250TM49
HAND AUTO		10250TS39	10250TM39	FOR. OFF REV.		10250TS50	10250TM50
HIGH LOW		10250TS40	10250TM40	FOR. SAFE REV.		10250TS69	10250TM69
JOG RUN		10250TS41	10250TM41	HAND OFF AUTO		10250TS51	10250TM51
MAN. AUTO		10250TS67	10250TM67	MAN. OFF AUTO		10250TS68	10250TM68
OFF ON		10250TS42	10250TM42	OPEN OFF CLOSE		10250TS53	10250TM53
OPEN CLOSE		10250TS43	10250TM43	RUN SAFE JOG		10250TS70	10250TM70
RUN JOG		10250TS44	10250TM44	UP OFF DOWN		10250TS54	10250TM54
SAFE RUN		10250TS45	10250TM45	ON STOP SAFE	Red	10250TS71	10250TM71
START JOG		10250TS46	10250TM46				
START STOP		10250TS47	10250TM47				
UP DOWN		10250TS48	10250TM48				

70 mm Round—Plastic Legend Plate



45 mm and 70 mm Plastic—Round

Color	Lettering	Field	Catalog Number
45 mm			
Blank		Yellow or red ^②	10250TRP78
70 mm			
Blank		Yellow or red ^②	10250TRP76
Red EMERG. STOP		Yellow	10250TRP79

For Push-Pull Units ^③

Legend	Color of Field	Square ^① Catalog Number	1/2 Round Catalog Number
Standard Size—Letters on Legend Plates Below are 3/32 in High			
PULL START/PUSH STOP	Green/red	10250TPP2	10250TR2
PUSH ON/PULL OFF	Black	10250TPP5	10250TR5
PULL OPEN/PUSH CLOSE	Black	10250TPP8	10250TR8
PULL UP/PUSH DOWN	Black	10250TPP11	10250TR11
Jumbo Size—Letters on Legend Plates Below are 1/8 in High			
PULL START/PUSH STOP	Green/red	10250TPP3	10250TR3
PULL ON/PUSH OFF	Black	10250TPP6	10250TR6
PULL OPEN/PUSH CLOSE	Black	10250TPP9	10250TR9
PULL UP/PUSH DOWN	Black	10250TPP12	10250TR12

Notes

- ^① Square legend plates have a satin aluminum field. Color is on lower portion.
^② If legend plate is to be engraved, specify field color required.
^③ All push-pull legend plates include the symbols ≠ ∅ in the center of the plate.

Blank and Custom Engraved Legend Plates



Style	Color					Four-Position Selector Switch		Push-Pull with Symbols ^④	
		Small Catalog Number	Standard Catalog Number	Jumbo ^① Catalog Number	Extra Large ^② Catalog Number	Custom ^③ Catalog Number	Standard Catalog Number	Standard Catalog Number	Jumbo ^① Catalog Number
Square ^⑤	Black	10250TMS36	10250TS36	10250TL36	—	10250TS76	10250TS72	10250TPP17	10250TPP18
	Red	10250TMS37	10250TS37	10250TL37	—	—	—	—	—
	Green/red	—	—	—	—	—	—	10250TPP20	10250TPP21
	Satin alum.	—	—	—	10250TNP99	—	—	—	—
1/2 Round	Black	10250TP36	10250TM36	10250TJ36	—	—	10250TM72	10250TR17	10250TR18
	Red	10250TP37	10250TM37	10250TJ37	—	—	—	—	—
	Green/red	—	—	—	—	—	—	10250TR20	10250TR21
	Satin alum.	—	10250TM89	10250TJ89	—	—	—	—	—

Notes

- ① Cannot be used on cast enclosures except for top row. Suitable for most sheet metal enclosures.
- ② When used to meet Ford Motor Co. specifications, specify engraved legend. Cannot be used on standard cast or sheet metal enclosures.
- ③ Slightly larger than standard size for legends requiring more space—fits cast enclosures.
- ④ All push-pull legend plates include the symbols ≠ ∅ in the center of the plate.
- ⑤ Square legend plates have a satin aluminum field. Color is on lower portion.

Accessories

Accessories









	Description	Catalog Number
Padlock Attachments		
	Padlocking Attachment for Flush Pushbutton Operators Permits locking NC contacts in open position with 1/4 in padlock. Will not lock NO contact.	10250TA2
	Padlocking Attachment for Use with Extended Pushbutton Permits locking NC contacts in open position with 1/4 in padlock.	10250TA26
	Padlocking Cover Guard Cover locked over flush button makes it inaccessible or on extended button locks NC contacts open. Takes 1/4 in shank size padlock.	10250TA36
	Padlock Hasp or Flip-Up Guard When used with a 1/4 in padlock, makes flush and long button and knob selector switch inaccessible, but not locked down. Without the padlock, it is a flip-up guard. Padlock hasp can be removed before assembly.	10250TA38
	Padlocking Attachment for Use with Flexible Weather Resistant Boot Used on long button operators. Stainless steel. Use only for locking NC contacts open.	10250TA63
	Padlock Attachment For use with illuminated pushbuttons and maintained push-pull operators having standard button or lens only. Use 1/4 in padlock. Locks in down position only.	10250TA64
	Padlocking Attachment for Non-Illuminated Knob Selector Switches Provision for up to 5, 1/4 in padlocks.	10250TA11
Shrouds and Guards		
	Shroud for Mushroom Head Operator Prevents accidental operation. (Not for push-pull operators.)	10250TA6
	Extended Retaining Nut Replaces standard nut and provides guard for flush head pushbutton operators.	10250TA12
	Guard for Illuminated Pushbutton	10250TA15
	Shroud For jumbo mushroom head operator. Gray	10250TA56
	Yellow	10250TA56Y
	Half Shroud—Yellow For jumbo mushroom head operator.	10250ED1241
	Fingerproof Shroud 10 per package Fits new style contact blocks and light units.	10250TA101











	Description	Catalog Number
Boots		
	Flexible Weather Resistant Boot For use with button operators (extended buttons preferred). Temperature to -25°F (-32°C). (See Page V9-T4-48 for 10250TA96 Tightening Tool.) Black	10250TA3
	Red	10250TA4 ①
	Green	10250TA10
	Transparent Boot For regular illuminated pushbutton operators and PresTest—Temperature to -38°F (-39°C). ②	10250TA25
	Boot for Flush Pushbutton Clear	10250TA46
	Black	10250TA47
	Red	10250TA48
	Green	10250TA49
Hardware and Kits		
	Thrust Washers To meet Ford Motor Co. mounting specifications.	10250TK3
	Contact Block Tape Seal Seals plunger openings on last contact block. Order in multiples of 10 pieces.	10250TK5
	Selector Switch Operator Gasket Seals out dust from getting in between the cam and contact block plungers. Supplied as standard with all selector switches.	56-9337
	Special Retaining Nut To accommodate thick panel: Indicating lights	10250TA30
	PresTest, pushbuttons and selector switches	10250TA31
	Terminal Block Two terminals, each will accommodate two wire terminations.	10250TA62
	Spacer Ring Used when legend plate is not required.	10250TA8
	Stacking Screw Replaces transformer mounting screws on indicating light so terminal block 10250TA62 can be mounted to light to support and connect a series resistor. This screw also fits all contact blocks. Order in multiples of 10.	10250TA79

Notes

- ① Should not be used on flush button for STOP function.
- ② Not suitable for single contact block depth cast enclosure. Cover is too thick.

Accessories, continued

Description	Catalog Number
Hardware and Kits, continued	
10250TA2_ 	Base Mounting Spacers ① Equivalent to contact block in depth—complete with screws, washers, etc. 1 block deep 10250TA22 2 block deep 10250TA23
10250TKG_ 	Grounding Kits Kits consist of a ring connector and a #6 screw for mounting connector to rear of contact block mounting screw. All components except standard indicating lights and PresTest indicating lights. 10250TKG1 Standard indicating lights 10250TKG2 ② PresTest indicating lights 10250TKG3 ②
10250TA7_ 	Contact Block Terminal Jumpers Available in multiples of 100 only. Terminal to terminal—within block (short) 100 per pkg. 10250TA70 1000 per pkg. 10250TA70-2 Terminal to terminal—block to block (long) 100 per pkg. 10250TA71 1000 per pkg. 10250TA71-2
Special Operators and Attachments	
10250TA5 	Wobble Stick 10250TA5 Complete with retaining nut—fits standard button.
10250TA14 	Lever Operator 10250TA14 For use with two vertically mounted flush pushbuttons.
10250TA_ 	Maintained Contact Attachment Release Button Assembly ① Mechanically interlocks with another pushbutton and contact block (not included). Provides mode indication. Minimum hole centers 1.62 in (41.1 mm), maximum 2.31 in (58.8 mm). Black 10250TA17 Red 10250TA18 Green 10250TA19 Yellow 10250TA20 Same with long button—black 10250TA39
10250TA1 	Maintained Contact Attachment ① 10250TA1 Mechanically interlocks two buttons and provides position indication for one. Use with two pushbutton operators and one or more contact blocks.
10250TA13 	Roto-Push Lever Operator 10250TA13 Used to provide lever operation for Roto-Push operators.

Description	Catalog Number
Special Light Modules	
10250TA79 	Master Test (Dual Input) Module Internal Form C relay suitable for either AC or DC applications. Total electrical isolation between monitored and test circuit. Fits all illuminated 10250T, E22, E30 and E34 devices. 48 Vdc 10250TMT8
10250TFL_ 	Flasher Module Changes any AC illuminated device to a controlled flashing light. Fits 10250T, E30 and E34 devices. 24V 10250TFL2 120V 10250TFL1
10250ED986-4 	Flashing Incandescent Lamp 10250ED986-4 For use with 120V transformer type or 6V full voltage type indicating lights including PresTest and most E29 devices.
Hole Plugs	
10250TA7 	Plug 10250TA7 For unused holes—steel, painted gray (stainless steel, use E30KT5)
Tools	
10250TA95 	Octagonal 10250T (notched to fit over selector switch lever), E29 and E30 10250TA95
E22CW 	E22, E30, E34 and octagonal 10250T (will not fit over selector switch levers) E22CW
10250TA96 	Tool for Tightening Boots 10250TA96 Used to install boot Catalog Numbers 10250TA3, A4, A10 and A25.
10250TA102 	10250T, E34 Allen Wrench 10250TA102 Used for removal of jumbo mushroom head.
10250TA74 	Lamp Removal Tools 10250TA74 For transformer type illuminated pushbuttons, push-pull and selector switches. Fits #12 lamp.
E30KV1 	For full voltage and resistor type illuminated pushbuttons, push-pull and selector switches and E30. E30KV1
E29KLT 	Standard indicating lights. Fits #44, #755, #6S6 and #10S6. E29KLT

Notes

- ① Component only. Not to be used for custom built (factory assembled) stations.
- ② Not suitable for single contact block depth cast enclosure. Cover is too thick.

Product Overview

Product Selection Guide



Description	E26
	Page V9-T4-50
Standards and Certifications	
	CE 60947-5-1 UL 508—File #E131568 cUL C22.2 No. 14—File #E131568
Ingress protection	Stacklight base and light units: IP65, Type 4, 4X and 13 Alarm units: IP20, Type 1
Electrical shock protection	Stacklight base and light unit: IP2X Alarm units: IPOX
Technical Data and Specifications	
Mechanical ratings	Shock (IEC 68-2-27): 11 ms, 15g Vibration (IEC 68-2-6): 10 sweeps 10–150 Hz, 2g Bump (IEC 68-2-29): 1000 pulses, 6 ms, 15g
Climate conditions	Operating: maximum 104°F (40°C) at 95% RH, Temperature –4° to 140°F (–20° to 60°C) Storage: temperature –40° to 176°F (–40° to 80°C)
Materials	Cover: polycarbonate Lenses: polycarbonate Stacklight base: nylon Extension tubes: aluminum Mounting base: zinc die cast
Terminals	14–30 AWG (2.5–0.05 mm ²) for single conductors and 18–26 AWG (0.75–0.14 mm ²) for two conductors of the same size. Do not mix solid and stranded wire in the same terminal. Recommended tightening torque is 4.4–5.3 lb-in (0.5–0.6 Nm)
Electrical ratings	Insulation voltage (U _i): 690V Operational voltage (U _o): 250V Impulse withstand voltage (U _{imp}): 1.5 kV
Bulb specifications	Incandescent lamp type: BA15d Maximum lamp wattage: 6W Bulbs—average life: Incandescent: 7,000–12,000 hrs. (based on voltage) Xenon flasher: 20,000 hrs. LED: 60,000–100,000 hrs. (based on colors)
LED/Incandescent comparison	Incandescent lamps Average operating life of 7,000 hours Each lamp can be used with any color lens Low cost results in short-term savings LED lamps Average operating life of 60,000–100,000 hours Low power consumption Extended life results in long-term savings

For our complete product offering, see Volume 7—Logic Control, Operator Interface and Connectivity Solutions, CA08100008E.

E26 Stacklights



4

Features

- Modular construction
- Six lens colors
- Variety of lamp types and voltages
- Mono-tonal, bi-tonal and intermittent audible alarms
- Combination of visible and audible alarms
- Modular components reduce inventory requirements, increase flexibility
- Steady and flashing modes allow one light to signal multiple conditions
- No-tools assembly permits easy lamp replacement

One, two and three-Light assembled stacklights:

- Base mountable
- Incandescent or LED versions
- 24V and 120V versions

Catalog Number Selection

E26 Stacklights

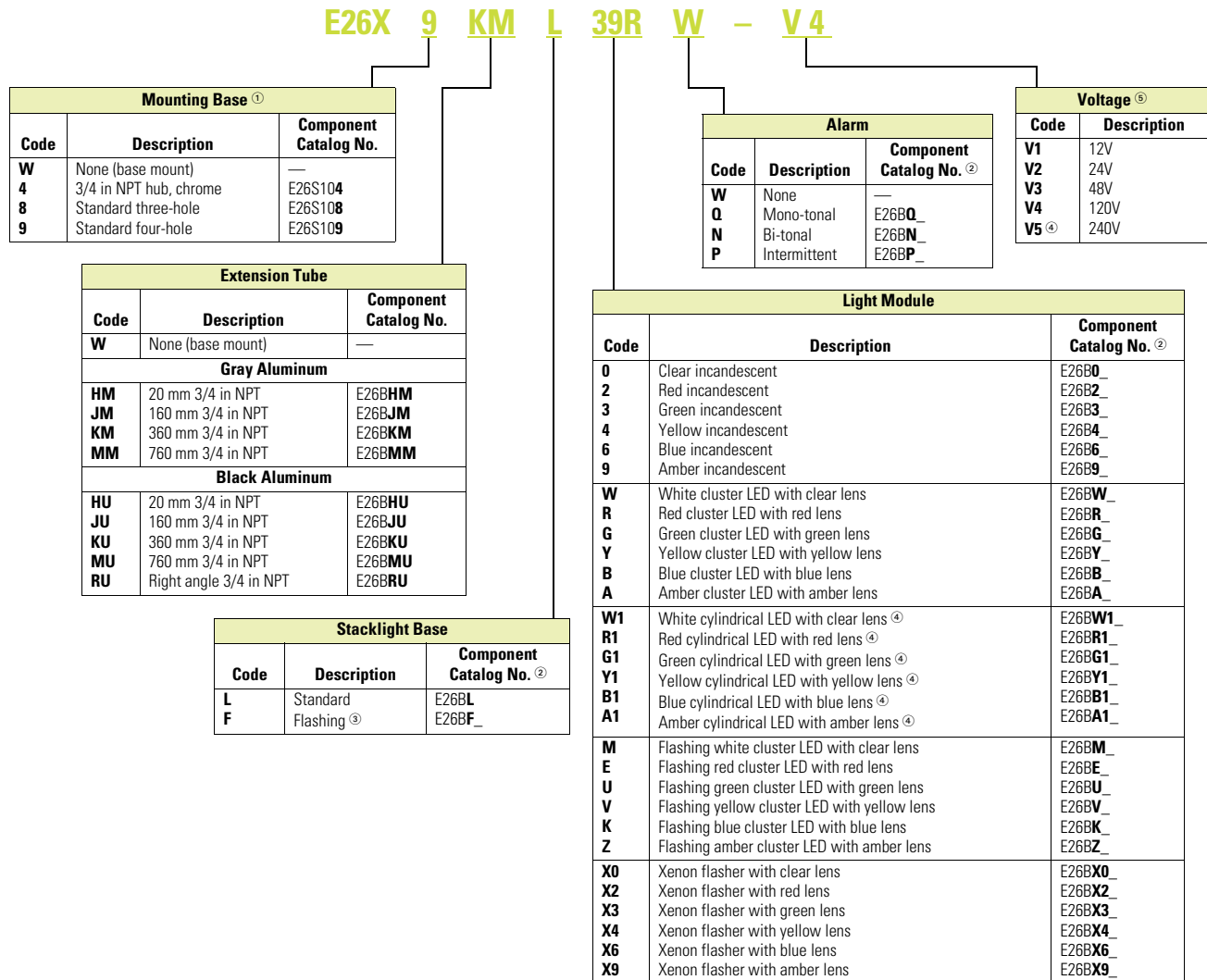

Voltage Codes

Voltage Code	Incandescent Lamp	Cluster LED	Cylindrical LED	Xenon Flasher	Flasher Base/Alarm
(Blank)	No lamp supplied	No LED supplied	No LED supplied	—	—
V1	12 Vac/Vdc	12 Vac/Vdc	12 Vac/Vdc	12 Vac/Vdc	12 Vac/Vdc
V2	24 Vac/Vdc	24 Vac/Vdc	24 Vac/Vdc	24 Vac/Vdc	24 Vac/Vdc
V3	48 Vac/Vdc	48 Vac/Vdc	48 Vac/Vdc	48 Vac/Vdc	48 Vac/Vdc
V4	120 Vac/Vdc	120 Vac	120 Vac	120 Vac	120 Vac/Vdc
V5	240 Vac/Vdc	240 Vac	—	240 Vac	240 Vac/Vdc

Notes

- ① Unless base mount is specified, an extension tube must be selected for a complete unit.
- ② Component catalog numbers for flashing bases, alarm units and light modules are incomplete and require the addition of a suffix code to specify the required voltage rating. See table above.
- ③ Flashing base is for use with incandescent lamps.
- ④ 240V not available for cylindrical LEDs.
- ⑤ If no voltage is specified, assembled stacklight will be supplied without lamps or LEDs.

Product Selection

Assembled Units

One-Light Unit Stacklight

Volts AC/DC	Alarm	First Level Color	Illumination Type	Catalog Number
24V	None	Red	Incandescent—steady	E26XWWL2W-V2
24V	None	Red	Cylindrical LED—steady	E26XWWL1W-V2
24V	None	Green	Incandescent—steady	E26XWWL3W-V2
24V	None	Green	Cylindrical LED—steady	E26XWWL1W-V2
24V	None	Amber	Incandescent—steady	E26XWWL9W-V2
24V	None	Amber	Cylindrical LED—steady	E26XWWL1W-V2
120V	None	Red	Incandescent—steady	E26XWWL2W-V4
120V ^①	None	Red	Cylindrical LED—steady	E26XWWL1W-V4
120V	None	Green	Incandescent—steady	E26XWWL3W-V4
120V ^①	None	Green	Cylindrical LED—steady	E26XWWL1W-V4
120V	None	Amber	Incandescent—steady	E26XWWL9W-V4
120V ^①	None	Amber	Cylindrical LED—steady	E26XWWL1W-V4

Two-Light Unit Stacklight

Volts AC/DC	Alarm	First Level Color	Illumination Type	Second Level Color	Illumination Type	Catalog Number
24V	None	Green	Incandescent—steady	Red	Incandescent—steady	E26XWWL32W-V2
24V	None	Green	Cylindrical LED—steady	Red	Cylindrical LED—steady	E26XWWL1R1W-V2
120V	None	Green	Incandescent—steady	Red	Incandescent—steady	E26XWWL32W-V4
120V ^①	None	Green	Cylindrical LED—steady	Red	Cylindrical LED—steady	E26XWWL1R1W-V4

Three-Light Unit Stacklight

Volts AC/DC	Alarm	First Level Color	Illumination Type	Second Level Color	Illumination Type	Third Level Color	Illumination Type	Catalog Number
24V	None	Green	Incandescent—steady	Amber	Incandescent—steady	Red	Incandescent—steady	E26XWWL392W-V2
24V	None	Green	Cylindrical LED—steady	Amber	Cylindrical LED—steady	Red	Cylindrical LED—steady	E26XWWL1A1R1W-V2
120V	None	Green	Incandescent—steady	Amber	Incandescent—steady	Red	Incandescent—steady	E26XWWL392W-V4
120V ^①	None	Green	Cylindrical LED—steady	Amber	Cylindrical LED—steady	Red	Cylindrical LED—steady	E26XWWL1A1R1W-V4

Note

^① LED modules have very low current draw and should not be used with triac output devices like PLC triac output modules. It is recommended that dry contact outputs be used to switch 120 Vac modules.

Replacement Parts

Stacklight Replacement Parts

Description	Notes	Diagram	Catalog Number
Replacement cover	Normally included with stacklight base	1	E26S68
Replacement lens O-ring	Normally included with light modules	2	E26S106 ①
Replacement lenses	Clear	3	E26S38
	Red		E26S39
	Green		E26S40
	Yellow		E26S41
	Blue		E26S42
	Amber		E26S43
Replacement Xenon strobe dual high (does not include lenses)	12 Vac/Vdc	4	E26S33
	24 Vac/Vdc		E26S34
	48 Vac/Vdc		E26S35
	120 Vac		E26S36
	240 Vac		E26S37
Replacement diffusers	White—normally supplied with incandescent light modules	4	E26S31
	Clear—normally supplied with LED light modules		E26S32
Replacement lamps	12V	5	E26S8
	24V		E26S9
	48V		E26S10
	120V		E26S11
	240V		E26S12
Replacement extension tube O-rings	Normally included with extension tubes	6	E26S107 ②
Replacement mounting gasket ③	Normally included with stacklight base	7	E26S105
Lamp removal tool	For E26 and E22 incandescent lamps		E22BA3

Typical Stacklight Assemblies

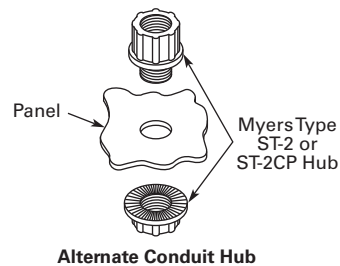
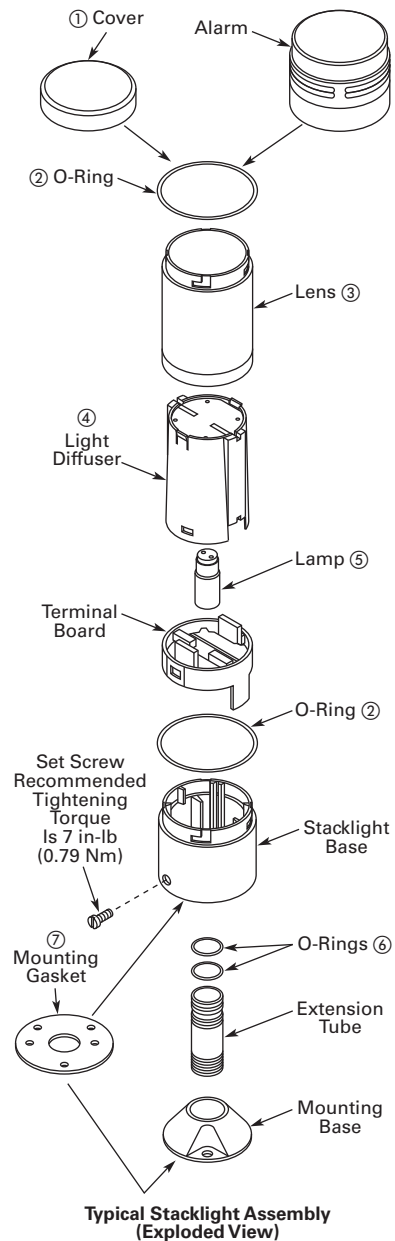

Notes

- ① Sold in packages of 5 pieces.
- ② Sold in packages of 10 pieces.
- ③ Mounting gaskets have two sets of mounting holes—one set with center-to-center spacing of 1.75 in (44.5 mm) and another set with center-to-center spacing of 1.65 in (42 mm).

Product Overview

Product Selection Guide

4



E5 Panel Meters



Eclipse Series Panel Meters

Description	E5 Panel Meters Page V9-T4-55	Eclipse Series Panel Meters Page V9-T4-55
Number of digits	5	4
Display technology	7-segment LED	7-segment LED
Display character height	8 mm	14 mm
Panel cut-out size	1/32 DIN (25 x 50 mm)	1/8 DIN (45 x 92 mm)
Available outputs	None	Dual relay, analog, RS-485
Available inputs	0–10V/2–10V/0–20 mA/4–20 mA	DC volt, AC volt, DC amp, AC amp, 5A AC, Temperature (J, K, T, PT100 RTD), 4–20 mA/0–10V/1–5V
Front panel protection	IP65	NEMA 4X
Connection method	Screw terminal	Depluggable screw terminals
Scaling	Programmable end points, linear interpolation	Programmable end points, linear interpolation
Input power options	10–30 Vdc	9–30 Vdc or 85–264 Vac
Update time	500 ms	400 ms
Automatic min/max capture	Yes	Yes
Input for display-hold	Yes	—

For our complete product offering, see Volume 7—Logic Control, Operator Interface and Connectivity Solutions, CA08100008E.

Digital Panel Meters



Features

E5-324-E digital panel meters

- Galvanic isolation with protection against incorrect polarity
- Automatic min/max value detection
- Freely programmable characteristic curve end points
- Input range:
 - Single current measuring input (0/4–20 mA)
 - Single voltage measuring input (0/2–10V)

Eclipse Series digital panel meters

- Four full digits
- 1/8 DIN size
- Red, LED display
- Scalable display
- Flashing alarms
- Min/max data hold
- Optional analog, relay and RS-485 outputs
- Type 4X

Catalog Number Selection

Digital Panel Meters

Eclipse Series

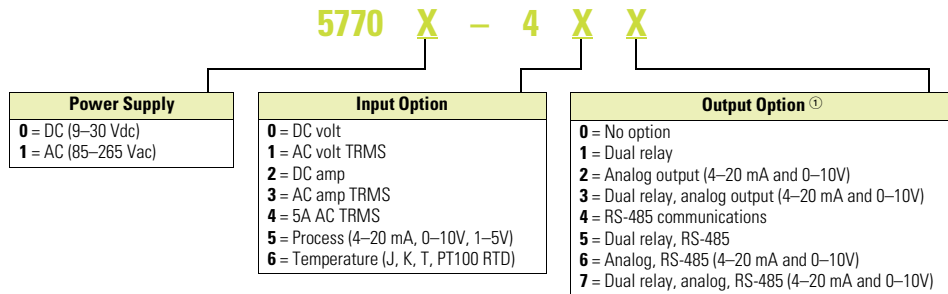

Product Selection

E5-324-E0402



E5-324-E0402

Description	Catalog Number
LED digital panel meter, 24 x 48 mm	E5-324-E0402

Eclipse Series



Eclipse Series

Description	Catalog Number
Digital ammeter—5A AC, 85–264 Vac power	57701440
Digital ammeter—5A AC, 85–264 Vac power, 2 relay outputs	57701441
Digital process meter—4–20 mA/0–10V, 85–264 Vac power	57701450
Digital process meter—4–20 mA/0–10V, 85–264 Vac power, 2 relay outputs	57701451
Digital process meter—4–20 mA/0–10V, 85–264 Vac power, 2 relay outputs and analog retransmission	57701453
Digital temperature meter, 85–264 Vac power	57701460
Digital temperature meter, 85–264 Vac power, 2 relay outputs	57701461

Note

① Output options 0, 2, 4 are not available for models -41X and -43X.

Product Overview

Operator Interfaces and Programming Software Selection Guide

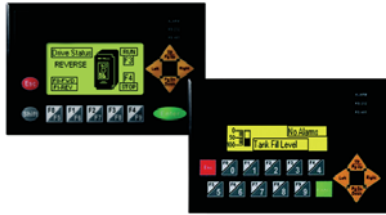

4

Description	ELC-GP Graphics Panel	HM/I Operator Interface
	Page V9-T4-59	Page V9-T4-60
Screen size	Two-line and four-line	3.5 in, 5.7 in, 8.0 in and 10.4 in
Screen options	Monochrome	Blue mode, grey scale, 256 color STN or 65k color TFT
Interface	Keypad only	Resistive touchscreen only or touchscreen and keypad
Communication ports	2 serial	3 serial; 1 or 2 USB; Expansion port for Ethernet Modbus TCP or Local I/O
Simultaneous protocols	1	3 or 4
Ethernet drivers	—	Yes
Upload/download	Serial cable	Serial, Ethernet, and/or USB
Operating system	Proprietary	Proprietary
Third-party software support	—	—
Screen saver	—	Yes

Operator Interfaces and Programming Software Selection Guide, continued



Description	XV Operator Interface	XP Operator Interface
	Page V9-T4-62	Page V9-T4-65
Screen size	3.5 in, 5.7 in, 7.0 in, 8.4 in and 10.4 in	8.4 in, 10.4 in, 12.1 in, 15.0 in and blind node (no screen)
Screen options	Color TFT, 64k colors; resolutions from QVGA (320 x 240) to WVGA (800 x 480)	Color TFT, 16 million colors; resolutions from SVGA (800 x 600) to UVGA (1600 x 1200)
Interface	Resistive touchscreen	Infrared, non-reflective safety glass
Communication ports	Ethernet, RS-232 and/or RS-485, USB	2 serial; 2 Ethernet; removable CompactFlash; 4 USB; VGA
Simultaneous protocols	3	5 or 8
Ethernet drivers	Yes	Yes
Upload/download	Serial, Ethernet, USB	Serial, Ethernet, USB
Operating system	Windows CE 5.0 Professional	Windows XP Embedded (protected)
Third-party software support	—	Yes
Screen saver	Yes	Yes

For our complete product offering, see Volume 7—Logic Control, Operator Interface and Connectivity Solutions, CA08100008E.

Software Product Selection Guide



Description	Visual Designer	Galileo	HMIsoft	ELCSoftGP
Overview	Feature-rich software package with SCADA functionality and web serving capabilities that can be run on XV, XP, ePro PS operator interfaces or personal computers	Intuitive visualization tool. Use Galileo on XV-102-H_ units or on XV units running CoDeSys when a stronger visualization package is needed	Use HMIsoft to create, edit, upload and download applications to the HMI family of operator interfaces	Use ELCSoftGP to create, edit, upload and download applications to ELC Graphics Panels
Catalog ID				
Development software seat license	VISUALDCE (CE hardware) VISUALDXP5 (5-pack of VISUALDXP) VISUALDCE5 (5-pack of VISUALDCE) VISUALDXP (PCs, XPe, and CE hardware)	SW-GALILEO-S SW-GALILEO-M	HMISOFT	ELCSOFTGP
Runtime software for a PC	VISUALRTPC	•	N/A	N/A
Time-Saving Editor Features				
Online and offline simulation	•	•	•	—
Macro capability	•	•	•	—
VB scripting	•	—	—	—
Math and Logic	•	•	•	—
Multi-language	•	•	•	—
System/internal variables	•	•	•	—
Auto-scale application to different resolution/screen size	•	•	•	—
Scripting (IF, THEN, ELSE, GOTO)	•	•	•	—
Symbol factory/library	•	•	•	—
Master pages	• Screen groups	• Screen groups	•	—
User-created controls	•	•	—	—
Customizable application symbols	•	•	—	—
Action lists/math worksheets	•	• With macros	• With macros	—
Reusable controls, images and pages	• Via indirect tag and/or PLC assignments	•	—	—
Advanced search and replace	•	•	—	—
Advanced context sensitive help	•	•	—	—
Conversion of legacy PanelMate™ configurations	•	—	—	—
Optional PanelBuilder™ conversion utility	•	—	—	—
Online configuration/editing	•	—	—	—

Software Product Selection Guide, continued



4

Description	Visual Designer	Galileo	HMSoft	ELCSoftGP
Runtime Features				
Clock synchronization	•	•	•	•
Sound actions or control	•	•	•	•
Security	• Advanced multi-level	•	• Multi-level	•
Pop-up screens	• And group screens	•	•	—
Animated graphics	•	•	•	—
Real-time trending	•	•	•	—
Recipes	•	•	•	—
Report generation	•	•	—	—
Timer scheduling	•	•	•	—
Calendar scheduling	•	—	—	—
Notification of data and events via e-mail/text messaging	•	—	—	—
Data archiving	•	•	•	—
Archive to shared network drive	•	No (-)	—	—
Alarm and event archiving	•	•	—	—
Historical trending	•	•	•	—
Import/export from XML	•	•	—	—
Database interface	• ADO.net compliant	—	—	—
Vision system interfaces	•	•	—	—
Secure document and Web network browser	•	—	—	—
Remote access and control without having to install software on the remote PC	• Web Thin Client with Internet Explorer	—	—	—
Automatic scaling of Web clients	•	—	—	—
Remote desktop	• With UltraVNC and RemoteClient	• VNC and RemoteClient	—	—
Launch/control third-party applications	•	—	—	—
2-touch controls for safety	•	—	—	—
Embedded PLC logic	—	—	•	—

ELC-GP Graphics Panel



Features

- Simple to program and easily connects to ELC products
- Protocols—include Modbus ASCII/RTU, ASCII Slave and vendor-specific protocols from Allen-Bradley®, Siemens®, Mitsubishi®, Koyo® and many more

Catalog Number Selection

ELC-GP Graphics Panel

ELC-GP

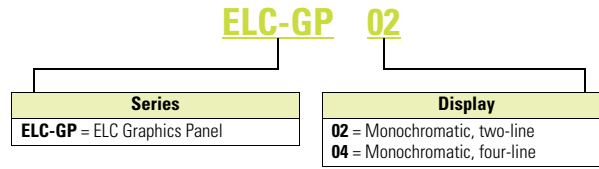

Product Selection

Graphics Panels

Description	Catalog Number
160 x 32 pixels, 10 function keys, monochrome	ELC-GP02
128 x 64 pixels, 10 function keys, monochrome	ELC-GP04

Accessories

Software and Accessories

Description	Catalog Number
Programming software for GP units	ELCSOFTGP
Program transfer module	ELC-GPXFERMOD
Cable, PC to ELC-GPxx, 9.8 ft (3m)	ELC-CBPCGP3
Power supply, 24 watt, 1 amp	ELC-PS01
Power supply, 48 watt, 2 amp	ELC-PS02

4.4

Operator Interface

Operator Interfaces and Programming Software

4

HMI Operator Interface



Features

- All units offer RS-232, RS-485 and RS-422 communications
- 6-, 8- and 10-inch models offer Ethernet communication options
- Retentive internal data storage

Catalog Number Selection

HMI Operator Interface

HMI

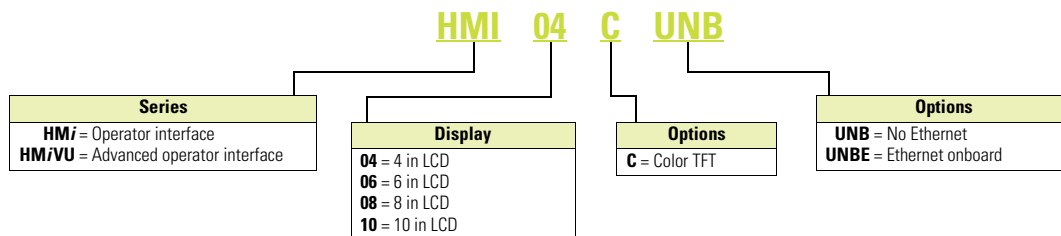

Product Selection

HMI Operator Interface

Description	Catalog Number
4-inch color TFT without expansion slot	HMI04CU
6-inch color TFT, no Ethernet	HMIVU06CUNB
8-inch color TFT, with Ethernet	HMIVU08CUNBE
10-inch color TFT, with Ethernet	HMIVU10CUNBE

Accessories

Software and Accessories

Description	Catalog Number
Programming software	HMISOFT

Kits

Description	Catalog Number
HMI spare parts kits (includes several power connectors, battery doors, gaskets, mounting clips, etc.)	HMI-SPKIT

Cable

Description	Catalog Number
1 meter cable to connect between the HMI and Eaton Logic Controller (ELC)	ELC-CBPCELC1
3 meter cable to connect between the HMI and Eaton Logic Controller (ELC)	ELC-CBPCELC3

Power Supply

Description	Catalog Number
1 amp 24 Vdc power supply	ELC-PS01
2 amp 24 Vdc power supply	ELC-PS02

XV Operator Interface



Features

- All XV models have a Microsoft Windows CE operating system
- Pre-licensed with Visual Designer runtime for up to 1500 tags, three simultaneous communication drivers, and one Web session
- Field upgrades are available for up to 4000 tags, three drivers, and two, four or eight simultaneous Web sessions

Catalog Number Selection

XV Operator Interface

XV

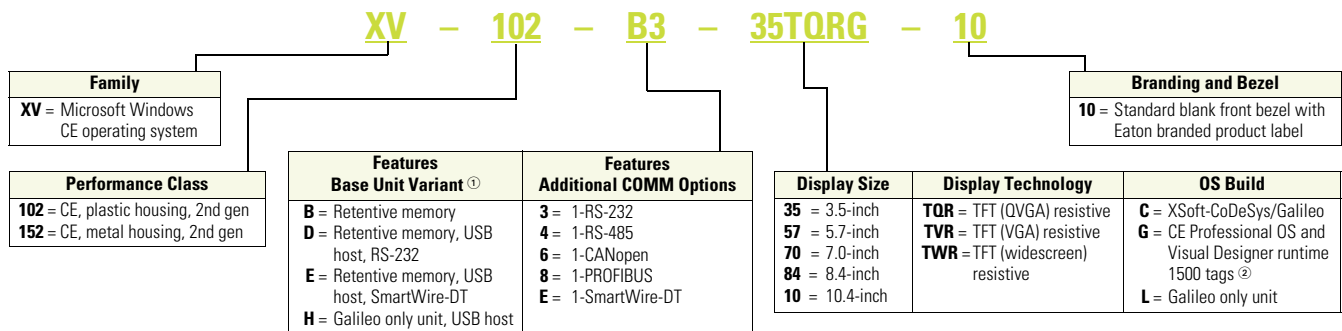

Product Selection

XV Operator Interface



XV Operator Interface with Visual Designer

Description	Catalog Number
XV 3.5-inch TFT, plastic housing, resistive touch, Ethernet and RS-232	XV-102-B3-35TQRG-10
XV 3.5-inch TFT, plastic housing, resistive touch, Ethernet and RS-485	XV-102-B4-35TQRG-10
XV 5.7-inch TFT, plastic housing, resistive touch, Ethernet, RS-232, RS-485	XV-102-D4-57TVRG-10
XV 7.0-inch TFT wide screen, plastic housing, resistive touch, Ethernet, RS-232, RS-485	XV-102-D4-70TWVRG-10
XV 5.7-inch TFT, metal housing, resistive touch, Ethernet, RS-232, RS-485	XV-152-D4-57TVRG-10
XV 8.4-inch TFT, metal housing, resistive touch, Ethernet, RS-232, RS-485	XV-152-D4-84TVRG-10
XV 10.4-inch TFT, metal housing, resistive touch, Ethernet, RS-232, RS-485	XV-152-D4-10TVRG-10

Notes

- ① All 1xx performance class units have 400 MHz processor, 64 MB DRAM, 1 x 10/100 Ethernet, and 1 x USB device.
- ② Standard software on embedded hardware. These XV models have a Microsoft Windows CE 5.0 Professional operating system and are pre-licensed with Visual Designer runtime for up to 1500 tags, 3 simultaneous communication drivers, and 1 Web session. Field upgrades are available for up to 4000 tags, 3 drivers, and 2, 4 or 8 simultaneous Web sessions.

XV Operator Interface with XSoft-CoDeSys

Description	Catalog Number
XV 3.5-inch TFT plastic housing, resistive touch, CANopen	XV-102-B6-35TQRC-10
XV 3.5-inch TFT plastic housing, resistive touch, PROFIBUS	XV-102-B8-35TQRC-10
XV 3.5-inch TFT plastic housing, resistive touch, SmartWire-DT	XV-102-BE-35TQRC-10
XV 5.7-inch TFT plastic housing, resistive touch, CANopen	XV-102-D6-57TVRC-10
XV 5.7-inch TFT plastic housing, resistive touch, PROFIBUS	XV-102-D8-57TVRC-10
XV 5.7-inch TFT plastic housing, resistive touch, CANopen, SmartWire-DT	XV-102-E6-57TVRC-10
XV 5.7-inch TFT plastic housing, resistive touch, PROFIBUS, SmartWire-DT	XV-102-E8-57TVRC-10
XV 7.0-inch TFT plastic housing, resistive touch, CANopen	XV-102-D6-70TWRC-10
XV 7.0-inch TFT plastic housing, resistive touch, PROFIBUS	XV-102-D8-70TWRC-10
XV 7.0-inch TFT plastic housing, resistive touch, CANopen, SmartWire-DT	XV-102-E6-70TWRC-10
XV 7.0-inch TFT plastic housing, resistive touch, PROFIBUS, SmartWire-DT	XV-102-E8-70TWRC-10
XV 5.7-inch TFT metal housing, resistive touch, CANopen	XV-152-D6-57TVRC-10
XV 5.7-inch TFT metal housing, resistive touch, PROFIBUS	XV-152-D8-57TVRC-10
XV 5.7-inch TFT metal housing, resistive touch, CANopen, SmartWire-DT	XV-152-E6-57TVRC-10
XV 5.7-inch TFT metal housing, resistive touch, PROFIBUS, SmartWire-DT	XV-152-E8-57TVRC-10
XV 8.4-inch TFT metal housing, resistive touch, CANopen	XV-152-D6-84TVRC-10
XV 8.4-inch TFT metal housing, resistive touch, PROFIBUS	XV-152-D8-84TVRC-10
XV 8.4-inch TFT metal housing, resistive touch, CANopen, SmartWire-DT	XV-152-E6-84TVRC-10
XV 8.4-inch TFT metal housing, resistive touch, PROFIBUS, SmartWire-DT	XV-152-E8-84TVRC-10
XV 10.4-inch TFT metal housing, resistive touch, CANopen	XV-152-D6-10TVRC-10
XV 10.4-inch TFT metal housing, resistive touch, PROFIBUS	XV-152-D8-10TVRC-10
XV 10.4-inch TFT metal housing, resistive touch, CANopen, SmartWire-DT	XV-152-E6-10TVRC-10
XV 10.4-inch TFT metal housing, resistive touch, PROFIBUS, SmartWire-DT	XV-152-E8-10TVRC-10

XV Operator Interface with Galileo Only

Description	Catalog Number
XV 3.5-inch TFT plastic housing, resistive touch, Ethernet RS-232	XV-102-H3-35TQRL-10
XV 3.5-inch TFT plastic housing, resistive touch, Ethernet RS-485	XV-102-H4-35TQRL-10
XV 5.7-inch TFT plastic housing, resistive touch, Ethernet RS-232	XV-102-H3-57TVRL-10
XV 5.7-inch TFT plastic housing, resistive touch, Ethernet RS-485	XV-102-H4-57TVRL-10
XV 7.0-inch TFT plastic housing, resistive touch, Ethernet RS-232	XV-102-H3-70TWRL-10
XV 7.0-inch TFT plastic housing, resistive touch, Ethernet RS-485	XV-102-H4-70TWRL-10

Visual Designer**Visual Designer Software**

Description	Catalog Number
Visual Designer Development Software License Key	
For CE hardware	VISUALDCE
For PCs, XPe and CE hardware	VISUALDXP
For CE hardware, 5-pack of VISUALDCE	VISUALDCE5
For PCs, XPe hardware, 5-pack of VISUALDXP	VISUALDXP5

4

Galileo Software**Galileo Development Software**

Description	Catalog Number
Single-seat license	SW-GALILEO-S
Multiple-seat license	SW-GALILEO-M

XSoft-CoDeSys-2**XSoft-CoDeSys-2 Software**

Description	Catalog Number
Single Seat License	SW-XSOFT-CODESYS-2-S
Multiple Seat License (3)	SW-XSOFT-CODESYS-2-M

Accessories**XV Family Accessories**

Description	Catalog Number
SD memory card for all XV models	MEMORY-SD-A1-S
Spare part kit for XV-102 models—1 power connector, 8 mounting brackets, 1 sealing strip, 1 touch pen	ACC-TP-57-KG-1 XV-102
Spare part kit for XV-152 models—1 power connector, 8 mounting brackets, 1 sealing strip, 1 touch pen	ACC-TP-10-12-RES-1

XP Operator Interface



Features

- All XP models have a Microsoft Windows XP embedded operating system
- Pre-licensed with Visual Designer runtime
- Standard models are licensed for 4000 tags, five simultaneous communication drivers, and one Web session
- Enterprise models are licensed for 64,000 tags, eight simultaneous communication drivers, and one Web session
- Field upgrades are available for up to 64,000 tags, eight drivers, and 2, 4, 8, 16, 32, 64, 128, or 256 simultaneous Web sessions

Catalog Number Selection

XP Operator Interface

XP

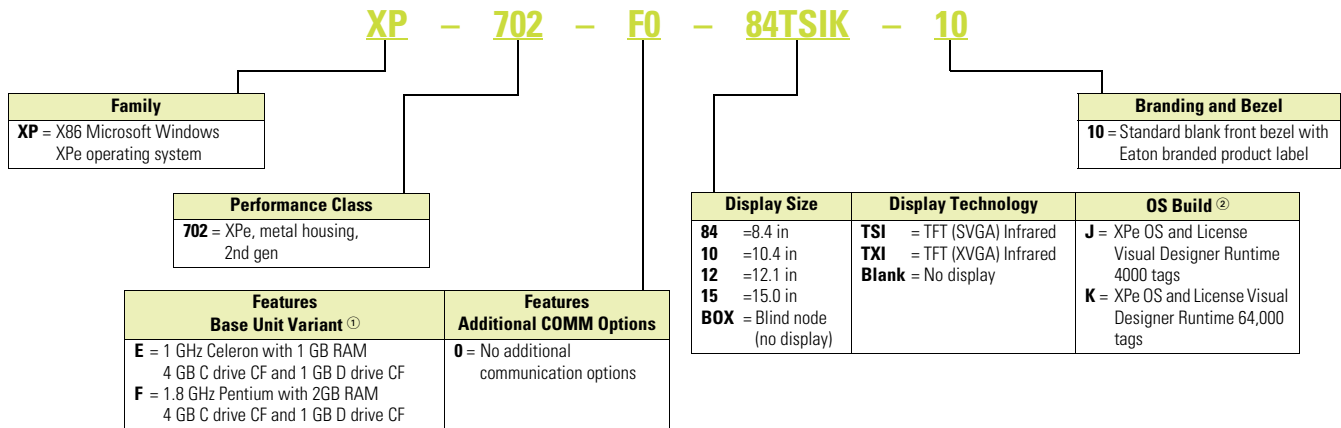

Notes

- ① All 7xx Performance Class units have 1 x 10/100, 1 x 10/100/1000 Ethernet, 4 x USB Host V2.0, 2 x RS-232.
- ② Standard software on embedded hardware.

Product Selection

XP Operator Interface

XP Operator Interface



Description	Catalog Number
XP 8.4 in TFT, 1 GHz Celeron, 1 GB RAM, 4 GB C drive, 1 GB D drive, 4000 tags, 5 drivers, 1 Web session	XP-702-E0-84TSIJ-10
XP 10.4 in TFT, 1 GHz Celeron, 1 GB RAM, 4 GB C drive, 1 GB D drive, 4000 tags, 5 drivers, 1 Web session	XP-702-E0-10TSIJ-10
XP 12.1 in TFT, 1 GHz Celeron, 1 GB RAM, 4 GB C drive, 1 GB D drive, 4000 tags, 5 drivers, 1 Web session	XP-702-E0-12TXIJ-10
XP 15.0 in TFT, 1 GHz Celeron, 1 GB RAM, 4 GB C drive, 1 GB D drive, 4000 tags, 5 drivers, 1 Web session	XP-702-E0-15TXIJ-10
XP blind node (no display), 1 GHz Celeron, 1 GB RAM, 4 GB C drive, 1 GB D drive, 4000 tags, 5 drivers, 1 Web session	XP-702-E0-BOXJ-10
XP 8.4 in TFT, 1.8 GHz Pentium, 2 GB RAM, 4 GB C drive, 1 GB D drive, 64k tags, 8 drivers, 1 Web session	XP-702-F0-84TSIK-10
XP 10.4 in TFT, 1.8 GHz Pentium, 2 GB RAM, 4 GB C drive, 1 GB D drive, 64k tags, 8 drivers, 1 Web session	XP-702-F0-10TSIK-10
XP 12.1 in TFT, 1.8 GHz Pentium, 2 GB RAM, 4 GB C drive, 1 GB D drive, 64k tags, 8 drivers, 1 Web session	XP-702-F0-12TXIK-10
XP 15.0 in TFT, 1.8 GHz Pentium, 2 GB RAM, 4 GB C drive, 1 GB D drive, 64k tags, 8 drivers, 1 Web session	XP-702-F0-15TXIK-10
XP blind node (no display), 1.8 GHz Pentium, 2 GB RAM, 4 GB C drive, 1 GB D drive, 64k tags, 8 drivers, 1 Web session	XP-702-F0-BOXK-10

Visual Designer

Visual Designer Software



Description	Catalog Number
Visual Designer Development Software License Key	
For PCs, XPe and CE hardware	VISUALDXP
For PCs, XPe hardware, 5-pack of VISUALDXP	VISUALDXP5
For a PC Runtime software license with a maximum of 64k tags, 8 drivers, 1 Web session	VISUALRTPC
Visual Designer development software and PC runtime software licenses for a max of 64k tags, 8 drivers, 1 Web session	VISUALRTDEVP

Galileo Software

Galileo Development Software



Description	Catalog Number
Single-seat license	SW-GALILEO-S
Multiple-seat license	SW-GALILEO-M

XSoft-CoDeSys-2

XSoft-CoDeSys-2 Software



Description	Catalog Number
Single Seat License	SW-XSOFT-CODESYS-2-S
Multiple Seat License (3)	SW-XSOFT-CODESYS-2-M

Limit Switches



Photoelectric Sensors



Inductive Sensors



Connectivity



5.1 Limit Switches

Product Overview	V9-T5-2
E47 Precision	V9-T5-3
Compact Prewired	V9-T5-4
E49 Mini Metal	V9-T5-5
E50 Heavy-Duty Plug-In	V9-T5-6
LS-Titan Miniature DIN Switches	V9-T5-7

5.2 Photoelectric Sensors

Product Overview	V9-T5-9
Enhanced 50 Series	V9-T5-10
SM Series	V9-T5-12
Comet Series	V9-T5-13
E58 Harsh-Duty Series	V9-T5-15

5.3 Inductive Sensors

Product Overview	V9-T5-17
iProx	V9-T5-19
E57 Premium+ Series	V9-T5-20
E57 Premium+ Series Short Barrel	V9-T5-21
Global Proximity	V9-T5-22
E52 Cube Style	V9-T5-23

5.4 Connectivity

Product Overview	V9-T5-24
Global Plus Connector Cables	V9-T5-25

For our complete product offering, see Volume 8—Sensing Solutions, CA08100010E,

Product Overview

Limit Switches Selection Guide



E47 Precision Switches



Compact Prewired Switches



E49 Mini Metal Switches



E50 Heavy-Duty Plug-in Switches



LS-Titan Miniature DIN Switches

Description	E47 Precision Switches	Compact Prewired Switches	E49 Mini Metal Switches	E50 Heavy-Duty Plug-in Switches	LS-Titan Miniature DIN Switches
	Page V9-T5-3	Page V9-T5-4	Page V9-T5-5	Page V9-T5-6	Page V9-T5-7
Overview	Specified when accurate repeatability, choice of operating forces and travel characteristics and tightly controlled action of cam or target in space restricted areas is of prime importance. Cost-effective and compact	Designed to be a versatile, slim device for hard-to-fit applications where sealing integrity is required; stackable ridge for ganged operations	Suitable for OEMs who require a small, cost-effective solution but cannot sacrifice durability and mechanical life as would be the case with a plastic IEC style switch	Versatile in design; high reliability; low maintenance costs with installation ease; best choice for heavy-duty limit switch applications; withstands physical and chemical abuse of harsh industrial environments	Eaton's LS-Titan limit switch line is a complete offering of safety position switches designed for worldwide application; economical insulated plastic or rugged metal enclosures and modular, plug-in operating heads and bodies make LS-Titan a flexible switching solution
Applications	Overhead, folding and elevator doors, sliding gates, automated guided vehicles and commercial instrumentation	Machine tool, food processing and packaging	Automatic vending machines, electronic assembly machines, elevators and lifts, injection molding, packaging	Punch presses, waste water treatment, machine tool, automotive, retrieval systems, industrial truck, car wash lines	Packaging, material handling, conveying, sorting and counting, positioning, and safety applications requiring positive opening contacts
Product features	Self-contained switches or with an enclosed cast housing for increased durability and conduit connection (1/2 in NPT) High current capacity for power load switching and motor handling capability Screw and solder terminations	Rugged aluminum alloy die cast housing Sealed construction with enclosure ratings of Type 4, 6 and 13 Prewired with 3M of 18 AWG, AWM 2517, 300V cable	Long life—rated for 10 million operations Pre-wired units with custom cable lengths available for high volume customers "Fingerproof" terminals protect against accidental shock	Modular operating heads, switch bodies and receptacles are interchangeable without field adjustment Order as complete assemblies or components for stocking and manufacturing flexibility 90 degree total travel, 5 degree pretravel characteristics are standard features	Modular, plug-in system (head and body components) Positive opening NC contacts for safety applications Wide variety of economical plastic and rugged metal versions available Operating heads can be rotated 90 degrees to suit specific direction of operation Unique electronic safety position switches (LSE models) provide analog (0–10 Vdc or 4–20 mA) outputs proportional to the actuator position and allow for easy configuration of a custom trip point Can be ordered as separate components (head and body) or as completely assembled switches
Contact ratings	NEMA A600, R300, AC-15, DC-13 15A/20A, 125 or 250 Vac	NEMA B300	5A at 250 Vac 5A at 30 Vdc	NEMA A600, R300 Lighted versions A150, R150 6A, 120 Vac; 10A continuous	AC-15, DC-13 6A at 240 Vac 3A at 24 Vdc 200 mA at 24 Vdc (LSE models)
Enclosure ratings	Enclosed—Type 1	Type 4, 6 and 13 IP67	IP65	Type 1, 3, 3S, 4, 4X, 6, 6P, 13 IP67	IP66, IP67
Construction	Basic—phenolic Enclosed—aluminum die cast	Aluminum alloy die cast	Zinc alloy	Zinc die cast	TBD
Approvals	UL® recognized CSA® certified	cULus	UL recognized	UL listed CSA certified IEC 947-5-1 TUV	Safety function by positive opening contacts per IEC/EN 60947-5-1 up to Category 4 per EN 954-1 TÜV-Rheinland certified for functional-safety (LSE models) CSA certified UL listed CE CCC

For our complete product offering, see Volume 8—Sensing Solutions, CA08100010E,

E47 Precision



Features

- The cost-effective solution for highly accurate switching applications
- Compact housings are ideal for use where space is restricted
- Precision, snap-action operators provide accurate repeatability of electrical and mechanical operating characteristics
- High current capacity (up to 20A) allows power load switching and motor handling capability
- Enclosed boot versions (shown on the left, in gray) shield actuators from debris
- Solder and spade terminals available
- 15A models shown, 20A models also available

Product Selection

E47 Precision

Basic Switches

Description	Type	Catalog Number 15A	Specifications ①
Straight lever	Screw terminal	E47BMS22	OF max.—2.47 oz (70g)
			RF min.—0.49 oz (14g)
			PT max.—0.394 in (10 mm)
			OT max.—0.220 in (5.6 mm)
			MD max.—0.051 in (1.3 mm)
			FP max.—1.11 in (28.2 mm)
Standard lever	Screw terminal	E47BMS20	OP—0.748 in (19 mm)
			OF max.—3.53 oz (100g)
			RF min.—0.99 oz (28g)
			PT max.—0.197 in (5.0 mm)
			OT max.—0.079 in (2.0 mm)
			MD max.—0.039 in (1.0 mm)
Cross roller plunger	Screw terminal	E47BMS11	FP max.—0.976 in (24.8 mm)
			OP—0.748 in (19 mm)
			OF max.—12.3 oz (350g)
			RF max.—4.02 oz (114g)
			PT max.—0.016 in (0.4 mm)
			OT max.—0.14 in (3.58 mm)
Extended roller lever	Screw terminal	E47BMS42	MD max.—0.002 in (0.05 mm)
			OP—1.315 in (33.4 mm)
			OF max.—5.64 oz (160g)
			RF min.—0.78 oz (22g)
			PT max.—0.28 in (7.1 mm)
			OT max.—0.16 in (4 mm)
Roller lever	Screw terminal	E47BMS30	MD max.—0.04 in (1.02 mm)
			FP max.—1.437 in (36.5 mm)
			OP—1.189 in (30.2 mm)
			OF max.—5.64 oz (160g)
			RF min.—1.48 oz (42g)
			PT max.—0.106 in (2.7 mm)
			OT max.—0.094 in (2.4 mm)
			MD max.—0.02 in (0.5 mm)
			FP Mmax.—1.28 in (32.5 mm)
			OP—1.189 in (30.2 mm)

Enclosed Switches

Description	Catalog Number	Specifications ①
Roller lever	E47BLS32	OF max.—20.1 oz (570g)
		RF min.—6.0 oz (1700g)
		PT max.—0.157 in (4.0 mm)
		OT max.—0.236 in (6.0 mm)
		MD max.—0.016 in (0.4 mm)
Booted roller lever	E47BLS33	OF max.—22.57 oz (640g)
		RF min.—8.11 oz (230g)
		PT max.—0.197 in (5.0 mm)
		OT max.—0.236 in (6.0 mm)
Booted roller plunger	E47BLS08 E47BLS12 (cross roller unit)	MD max.—0.016 in (0.4 mm)
		OF max.—17.64 oz (500g)
		RF min.—3.53 oz (100g)
		PT max.—0.039 in (1.0 mm)
		OT max.—0.138 in (3.5 mm)
Booted wobble	E47BLS14	MD max.—0.005 in (0.12 mm)
		OP—1.957 in (49.7 mm)
		OF max.—2.11 oz (60g)
		RF min.—0.88 oz (25g)
		PT max.—0.520 in (13.2 mm)
		OT max.—0.315 in (8.0 mm)
		MD max.—0.039 in (1.0 mm)

Note

- ① OF = Operating Force; RF = Return Force; PT = Pre-Travel; OT = Overtravel; MD = Movement Differential; FP = Free Position; OP = Operating Position.

Compact Prewired



5

Features

- Rugged and dependable compact limit switch
- Rugged aluminum alloy die cast housing
- Sealed construction with enclosure ratings of Type 4, 6 and 13
- Prewired with 3m of 18 AWG, AWM 2517, 300V cable
- Stackable ridge for ganged operation

Product Selection

Compact Prewired

Compact Prewired

Actuator Type	Operating Force (Maximum)	Reset Force (Minimum)	Overtravel (Minimum)	Pre-Travel	Movement Differential (Maximum)	Operating Position	Catalog Number
Pin plunger	42.3 oz (1.2 kg)	15.9 oz (450g)	0.118 in (3 mm)	0.07 in (1.8 mm)	0.008 in (0.2 mm)	0.62 ± 0.04 in (15.7 ± 1 mm)	E47BCC05
Sealed plunger	63.5 oz (1.8 kg)	15.9 oz (450g)	0.118 in (3 mm)	0.07 in (1.8 mm)	0.008 in (0.2 mm)	0.99 ± 0.04 in (24.9 ± 1 mm)	E47BCC06
Roller plunger	42.3 oz (1.2 kg)	15.9 oz (450g)	0.118 in (3 mm)	0.07 in (1.8 mm)	0.008 in (0.2 mm)	1.12 ± 0.04 in (28.5 ± 1 mm)	E47BCC07
Sealed roller plunger	63.5 oz (1.8 kg)	15.9 oz (450g)	0.118 in (3 mm)	0.07 in (1.8 mm)	0.008 in (0.2 mm)	1.35 ± 0.04 in (34.3 ± 1 mm)	E47BCC08
Cross roller plunger	42.3 oz (1.2 kg)	15.9 oz (450g)	0.118 in (3 mm)	0.07 in (1.8 mm)	0.008 in (0.2 mm)	1.12 ± 0.04 in (28.5 ± 1 mm)	E47BCC11
Sealed cross roller plunger	63.5 oz (1.8 kg)	15.9 oz (450g)	0.118 in (3 mm)	0.07 in (1.8 mm)	0.008 in (0.2 mm)	1.35 ± 0.04 in (34.3 ± 1 mm)	E47BCC12
Bevel plunger	42.3 oz (1.2 kg)	15.9 oz (450g)	0.118 in (3 mm)	0.07 in (1.8 mm)	0.008 in (0.2 mm)	1.12 ± 0.04 in (28.5 ± 1 mm)	E47BCC13
Roller lever	20.5 oz (580g)	5.3 oz (150g)	40°	25° max.	3°	—	E47BCC15
Wobble stick	5.3 oz (150g)	—	—	15° max.	—	—	E47BCC20

E49 Mini Metal



Features

- Long life—rated for 10 million operations
- “Fingerproof” terminals protect against accidental shock
- Double-spring mechanism for contact reliability
- Captive screws on enclosure cover make wiring hassle-free
- SPDT double break

Product Selection

E49 Mini Metal

E49 Mini Metal

Operating Head Type	Specifications			Force to Operate Contacts	Minimum Return Force	Catalog Number—Assembled Units (Switch Body and Head) 1NO-1NC Contacts
	Travel to Operate Contacts	Travel to Reset Contacts	Total Travel			
Side rotary lever	20°	12°	70°	750g	100g	E49G31AP3
Adjustable side rotary lever	20°	12°	70°	750g	100g	E49G31UP3
Top pushbutton	0.06 in (1.5 mm)	0.04 in (1 mm)	0.22 in (5.5 mm)	900g	150g	E49G31BP3
Top push roller	0.06 in (1.5 mm)	0.04 in (1 mm)	0.22 in (5.5 mm)	900g	150g	E49G31CP3
Top push roller (90 degree roller)	0.06 in (1.5 mm)	0.04 in (1 mm)	0.22 in (5.5 mm)	900g	150g	E49G31C1P3
Adjustable rod lever	20°	12°	70°	750g	100g	E49G31DP3
Wobble stick (nylon coil)	1.18 in (30 mm)	—	—	150g	—	E49G31NP3
Wobble stick (metal coil)	1.18 in (30 mm)	—	—	150g	—	E49G31VP3
Wobble stick (metal rod)	1.18 in (30 mm)	—	—	150g	—	E49G31MP3
Wobble stick (whisker)	1.18 in (30 mm)	—	—	150g	—	E49G31XM3

E50 Heavy-Duty Plug-In



Features

- Modular, plug-in components (head, body and receptacle) provide application flexibility, reduced inventory and less downtime
- Manufactured to take the physical and environmental abuse (including cutting fluids and chemicals) of harsh industrial environments
- Chemical-resistant Viton® gaskets, seals and boots are standard, and so are captive, posi-drive screws
- 600V rating, ridge-topped contacts and wiping action assure continuity even to logic level circuits
- Rotary heads are field convertible clockwise, counterclockwise or both, without special tools

Product Selection

E50 Heavy-Duty Plug-In

Assembled Switches—Standard

Note: Order assembled (as shown in this product guide) or as head, body, receptacle and lever components.

Operating Head Type		Catalog Number
Side rotary (requires an operating lever)	Standard spring return—E50DR1 ①	E50AR1
	Low force spring return—E50DL1 ①	E50AL1
	Maintained two-position—E50DM1	E50AM1
Side pushbutton, spring return—E50DS1		E50AS1
Side pushbutton, adjustable spring return—E50DS2		E50AS2
Side push roller, spring return—E50DS3 ②		E50AS3
Side pushbutton, maintained—E50DH1		E50AH1
Top pushbutton, spring return—E50DT1		E50AT1
Top pushbutton, adjustable spring return—E50DT2		E50AT2
Top push roller, spring return—E50DT3 ②		E50AT3
Wobble head, spring return (requires a wobble operator)	Standard duty—E50DW1	E50AW1
	Heavy-duty high strength steel—E50DW2	E50AW2

Notes

① CW (clockwise) and CCW (counterclockwise) operation, easily convertible to CW only or CCW only operation.

② Roller can be converted in the field between horizontal and vertical.

LS-Titan Miniature DIN Switches





Features

- Modular, plug-in system (head and body components)
- Safety rated, with positive opening contacts and TUV certification on electronic (LSE) models
- Wide variety of economical plastic and rugged metal versions available
- Operating heads can be rotated 90 degrees to suit specific direction of operation
- Unique electronic safety position switches (LSE models) provide analog (0–10 Vdc or 4–20 mA) outputs proportional to the actuator position and allow for easy configuration of a custom trip point
- Can be ordered as separate components (head and body) or as completely assembled switches

Product Selection

LS-Titan Miniature DIN Switches

Plastic Safety Switches

Switch Body Catalog Number	LS-S02	LS-S20A	LS-S11S
Output Function	2NC with positive opening contacts	2NC with slow make/break	1NO and 1NC with positive opening contact
Terminal Connection	Screw terminal ①	Screw terminal ①	Screw terminal ①
Contact Sequence			

Description	Operating Head Type	Catalog Number—Assembled Switches		
	Catalog Number—Heads Only			
Top push roller plunger	LS-XP	LS-S02-P	LS-S20A-P	LS-S11S-P
Short roller lever	LS-XLS	LS-S02-LS	LS-S20A-LS	LS-S11S-LS
Angled roller	LS-XLA	LS-S02-LA	LS-S20A-LA	LS-S11S-LA
Rotary lever	LS-XRL	LS-S02-RL	LS-S20A-RL	LS-S11S-RL
Adjustable roller lever (with 18 mm roller)	LS-XRLA	LS-S02-RLA	LS-S20A-RLA	LS-S11S-RLA
Adjustable roller lever (with 40 mm roller)	LS-XRLA40	LS-S02-RLA40	LS-S20A-RLA40	LS-S11S-RLA40
Spring rod (wobble) ②	LS-XS	LS-S02-S	LS-S20A-S	LS-S11S-S

Notes

① Cage clamp versions available. Contact Application Engineering.

② Not to be used as a safety position switch. Use only in conjunction with snap-action contact.

5.1

Sensors and Limit Switches

Limit Switches

Plastic Electronic Safety Position Switches

Switch Body Catalog Number	LSE-AI	LSE-AU
Output Function	Analog 4–20 mA	Analog 0–10V
Safety Functions and Approvals	Additional diagnostic output that registers a 0V signal in the event of a fault. Self-test function continuously tests both outputs for overloads, short circuits to 0V and short circuits to +Ue. Certified by TÜV to EN 954-1, Category 3 or 4. Suitable for protection of people or processes.	
Contact Sequence	Analog 4–20 mA	Analog 0–10V

Operating Head Type	Catalog Number—Heads Only	Catalog Number—Assembled Switches
----------------------------	----------------------------------	--

Description	Operating Head Type Catalog Number—Heads Only	Catalog Number—Assembled Switches	
Top push roller plunger	LS-XP	LSE-AI-P	LSE-AU-P
Short roller lever	LS-XLS	LSE-AI-LS	LSE-AU-LS
Angled roller	LS-XLA	LSE-AI-LA	LSE-AU-LA
Rotary lever	LS-XRL	LSE-AI-RL	LSE-AU-RL
Adjustable roller lever (with 18 mm Roller)	LS-XRLA	LSE-AI-RLA	LSE-AU-RLA
Adjustable roller lever (with 40 mm roller)	LS-XRLA40	LSE-AI-RLA40	LSE-AU-RLA40
Spring rod (wobble) ①	LS-XS	LSE-AI-S	LSE-AU-S

Note

① Not to be used as a safety position switch. Use only in conjunction with snap-action contact.

5

Product Overview

Photoelectric Sensors Selection Guide



Description	Enhanced 50 Series	SM Series	Comet Series	E58 Harsh-Duty Series
	Page V9-T5-10	Page V9-T5-12	Page V9-T5-13	Page V9-T5-15
Overview	Provides outstanding optical performance and application flexibility in a self-contained, industry-standard compact rectangular	Provides high performance and ease of use in an economical, miniature package	This high-performance, 18 mm flat tubular sensor family features a wide variety of models in all sensing modes	Designed to withstand the harshest physical, chemical and optical environments; available in 18 and 30 mm tubular enclosures
Sensing types and ranges	Thru-beam: 200 and 500 ft Reflex: 30 ft Polarized reflex: 16 ft Diffuse reflective: 5 and 10 ft Clear object detector: 45 in Infrared fiber optic: range varies with fiber Visible fiber optic: range varies with fiber	Thru-beam: 50 ft Polarized reflex: 10 ft Diffuse reflective: 8 in Perfect Prox [®] background rejection: 2 and 4 in	Thru-beam: 20 and 80 ft Reflex: 25 ft Polarized reflex: 15 and 10 ft Diffuse reflective: 8 and 24 in Focused diffuse reflective: 1.6 in Wide single diffuse: 6 in Fine spot Perfect Prox: 2 in Perfect Prox background rejection: 2, 4, 6 and 9 in Glass and plastic fiber optic: range varies with fiber	Thru-beam: 800 ft Reflex: 59 ft Polarized reflex: 34 ft Perfect Prox background rejection: 2, 4, 6 and 11 in
Product features	High optical performance, including 10-ft diffuse and 500-ft thru-beam versions Output options include a high-current 10A SPDT relay Built-in light/dark selection on all models	Highly visible LED indicators for power, output and alignment (TargetLock) TargetLock simplifies setup and ensures that the sensor operates at the highest level of reliability possible Perfect Prox models sense different colored targets at the same range and ignore objects in the background	The 18 mm tubular body has flat sides for added mounting flexibility Available in universal voltage AC/DC versions as well as DC only models Short circuit protection on all models	Designed to be the most rugged photoelectric sensor available Perfect Prox background rejection technology for unmatched optical performance Output status indicator is the brightest available and is visible from any angle and in any lighting condition
Operating voltage	24–240 Vac and 12–240 Vdc 10–40 Vdc	18–264 Vac and 18–50 Vdc 10–30 Vdc	90–132 Vac and 18–50 Vdc 20–264 Vac and 15–30 Vdc 10–30 Vdc	Two-wire models: 90–132 Vac and 18–50 Vac Three- and four-wire models: 20–132 Vac and 15–30 Vdc 10–30 Vdc
Output function	Selectable light or dark operate	Light and dark operate models available	Selectable light or dark operate	Light and dark operate models available
Maximum load current	DC units: 250 mA AC/DC units: 300 mA to 10A	AC/DC units—200 mA DC units—100 mA (NPN or PNP)	AC/DC units—300 mA DC units—250 mA (NPN), 100 mA (PNP)	AC/DC units—300 mA (100 mA for 18 mm diameter units) DC units—250 mA (NPN), 100 mA (PNP)
Enclosure ratings	IP67	Type 1, 3, 4, 4X, 6, 6P, 12 and 13 IP68	Type 1, 2, 3, 4, 4X, 6, 12 and 13	Type 1, 2, 3, 3R, 3S, 4, 4X, 6, 6P, 12, 12K and 13 IP69K
Response time range	DC operation: 2 ms AC operation: 15 ms	DC operation: 1 ms AC operation: 16 ms	DC operation: 1 ms AC operation: 10 ms 2W AC/DC operation: 32 ms	2 ms to 35 ms
Approvals	CSA approved Certified to UL standard, UL 508	UL listed cUL listed	UL recognized cUL recognized	UL listed cUL listed

Enhanced 50 Series



5

Features

- High-optical performance models, including a 500 ft (152m) thru-beam and a 10 ft (3m) diffuse reflective unit
- Output options include a 3A SPDT relay
- All units offer light/dark selection
- Logic options include ON-delay, OFF-delay and one-shot delay
- Fully potted construction for use in areas subject to washdown, high shock and/or vibration
- Choice of pre-wired power cable, built-in mini-connector, built-in micro-connector and pigtail micro-connector versions; standard pre-wired cable length is 6 ft (1.8m)

Product Selection

Enhanced 50 Series

Enhanced 50 Series Sensors

Description	Voltage Range	Sensing Range	Optimum Range	Sensing Beam	Thru-Beam Component	Output Type	Time Delay	Connection Type	Catalog Number
Thru-beam standard range	10–40 Vdc	200 ft (61m)	0.1–100 ft (0.03–31m)	Infrared	Source	N/A	N/A	4-pin Euro (micro) connector	1150E-6547
					Detector	NPN/PNP 250 mA	No		1250E-6547
	12–240 Vdc 24–240 Vac	200 ft (61m)	0.1–100 ft (0.03–31m)	Infrared	Source	N/A	N/A	4-pin micro connector	1150E-6543
					Detector	Isolated output solid-state relay 300 mA at 240 Vac/Vdc	No		1250E-6543
Thru-beam extended range	10–40 Vdc	500 ft (152m)	0.1–250 ft (0.03–77m)	Infrared	Source	N/A	N/A	4-pin Euro (micro) connector	1151E-6547
					Detector	NPN/PNP 250 mA	No		1251E-6547
	12–240 Vdc 24–240 Vac	500 ft (152m)	0.1–250 ft (0.03–77m)	Infrared	Source	N/A	N/A	4-pin micro connector	1151E-6543
					Detector	Isolated output solid-state relay 300 mA at 240 Vac/Vdc	No		1251E-6543
					N/A	N/A	4-pin mini-connector	1151E-6504	
						SPDT EM relay 3A at 120 Vac	No	5-pin mini-connector	1251E-6504

Reflex, Diffuse, and Clear Object Sensors

Description	Voltage Range	Sensing Range ^①	Optimum Range ^①	Sensing Beam	Output Type	Time Delay	Connection Type	Catalog Number
Standard reflex	10–40 Vdc	30 ft (9m)	0.5–15 ft (0.2–4.6m)	Visible red	NPN/PNP 250 mA	No	4-pin Euro (micro) connector	1450E-6547
	12–240 Vdc 24–240 Vac	30 ft (9m)	0.5–5 ft (0.2–4.6m)	Visible red	isolated output solid-state relay 300 mA at 240 Vac/Vdc	No	4-pin micro connector	1450E-6543
					SPDT EM relay 3A at 120 Vac	No	5-pin mini-connector	1450E-6504
Polarized reflex ^②	10–40 Vdc	16 ft (4.9m)	0.5–8 ft (0.2–2.5m)	Visible red	NPN/PNP 250 mA	No Yes	4-pin Euro (micro) connector	1451E-6547 1451E-8547
	12–240 Vdc 24–240 Vac	16 ft (4.9m)	0.5–8 ft (0.2–2.5m)	Visible red	Isolated output solid-state relay 300 mA at 240 Vac/Vdc	No	4-pin micro connector	1451E-6543
					SPDT EM relay 3A at 120 Vac	No	5-pin mini-connector	1451E-6504
Diffuse reflective extended range	10–40 Vdc	10 ft (3m) ^③	1–60 in (25–1520 mm) ^③	Infrared	NPN/PNP 250 mA	No	4-pin Euro (micro) connector	1351E-6547
	12–240 Vdc 24–240 Vac	10 ft (3m) ^③	1–60 in (25–1520 mm) ^③	Infrared	Isolated output solid-state relay 300 mA at 240 Vac/Vdc	No	4-pin micro connector	1351E-6543
					SPDT EM relay 3A at 120 Vac	No	5-pin mini-connector	1351E-6504
Clear object detector	10–40 Vdc	45 in (1.2m)	1–24 in (25–610 mm)	Visible red	NPN/PNP 250 mA	No	4-pin Euro (micro) connector	1452E-6547
	12–240 Vdc 24–240 Vac	45 in (1.2m)	1–24 in (25–610 mm)	Visible red	Isolated output solid-state relay 300 mA at 240 Vac/Vdc	No	4-pin micro connector	1452E-6543
					SPDT EM relay 3A at 120 Vac	No	5-pin mini-connector	1452E-6504

Notes

- ① Ranges based on 3 in retroreflector for reflex sensors.
 ② Polarized sensors may not operate with reflective tape. Test tape selection before installation.
 ③ Ranges based on 90% reflectance white card for diffuse reflective sensors.

SM Series



Features

- TargetLock technology makes SM Series™ the easiest photoelectric sensor to set up and use
- Highly visible LED indicators for power, output and TargetLock
- TargetLock simplifies setup and ensures the sensor operates at the highest level of reliability possible
- Perfect Prox models sense different colored targets at the same range and ignore objects in the background
- Visible beam on all models lets you see exactly where the sensor is pointing
- Compact size to fit in tight spaces
- Multiple mounting options, including industry-standard 18 mm threads
- Reverse polarity, overload and short circuit protection
- Full family includes thru-beam, polarized reflex, diffuse reflective and Perfect Prox background rejection

Product Selection

SM Series

SM Series Sensors

Description	Operating Voltage	Sensing Range ^①	Optimum Range ^②	Cutoff Range	Field of View	Thru-Beam Component	Connection Type	Light Operate Catalog Number	Dark Operate Catalog Number
Three-Wire and Four-Wire Sensors									
Thru-beam	10–30 Vdc	50 ft (15m)	0.1–25 ft (30 mm–7.5m)	—	10 in (254 mm) diameter at 10 ft (3m)	Source	4-pin micro DC connector	E65-SMTS15-HAD	—
						Detector	4-pin micro DC connector	—	E65-SMTD15-HDD
Polarized reflex	18–264 Vac 50/60 Hz or 18–50 Vdc	10 ft (3m)	0.1–5 ft (30 mm–1.5m)	—	1 in (25 mm) diameter at 50 in (1.3m)	—	4-pin micro AC connector	—	E65-SMPR3-GDD
	10–30 Vdc	10 ft (3m)	0.1–5 ft (30 mm–1.5m)	—	1 in (25 mm) diameter at 50 in (1.3m)	—	4-pin micro AC connector	—	E65-SMPR3-HDD
Diffuse reflective	18–264 Vac 50/60 Hz or 18–50 Vdc	8 in (200 mm)	0.25–5 in (6–127 mm)	—	2 in (50 mm) diameter at 5 in (127 mm)	—	4-pin micro AC connector	E65-SMSD200-GLD	—
	10–30 Vdc	8 in (200 mm)	0.25–5 in (6–127 mm)	—	2 in (50 mm) diameter at 5 in (127 mm)	—	4-pin micro DC connector	E65-SMSD200-HLD	—
Perfect Prox	18–264 Vac 50/60 Hz or 18–50 Vdc	2 in (50 mm)	0.4–1.8 in (10–45 mm)	2.3 in (58 mm) and beyond	0.25 in (6 mm) diameter at 2.25 in (57 mm)	—	4-pin micro AC connector	E65-SMPP050-GLD	—
	10–30 Vdc	2 in (50 mm)	0.4–1.8 in (10–45 mm)	2.3 in (58 mm) and beyond	0.25 in (6 mm) diameter at 2.25 in (57 mm)	—	4-pin micro DC connector	E65-SMPP050-HLD	—

Notes

- ^① Sensor will detect a 90% reflectance white card at this range.
^② Sensor will ignore a 90% reflectance white card at this range.

Comet Series



Features

- Industry-standard 18 mm diameter threaded body has flat sides allowing it to be mounted like a tubular sensor or against any flat surface
- Right-angle viewing models mount in a depth of only 6/10th of an inch
- Perfect Prox technology provides exceptional background rejection and application problem-solving
- Visible sensing beams let you see where the beam is aimed for quick setup and alignment
- Solid polyurethane housing completely encapsulates internal circuits for high resistance to shock and vibration

Product Selection

Comet Series

Reflex Sensors

Description	Operating Voltage	Sensing Range ^①	Optimum Range ^①	Field of View	Sensing Beam	Connection Type	Catalog Number
Three-Wire and Four-Wire Sensors							
Standard reflex forward viewing	20–264 Vac 50/60 Hz or 15–30 Vdc (NPN)	25 ft (7.6m)	0.1–15 ft (0.03–4.5m)	1 in (25 mm) diameter at 50 in (1.3m)	Visible red beam	4-pin micro AC connector	14102AQD03
	10–30 Vdc (NPN and PNP)	25 ft (7.6m)	0.1–15 ft (0.03–4.5m)	1 in (25 mm) diameter at 50 in (1.3m)	Visible red beam	4-pin micro DC connector	14102AQD07
Polarized reflex forward viewing ^②	20–64 Vac 50/60 Hz or 15–30 Vdc (NPN)	15 ft (4.5m)	0.1–15 ft (0.03–4.5m)	1 in (25 mm) diameter at 50 in (1.3m)	Visible red beam	4-pin micro AC connector	14101AQD03
	10–30 Vdc (NPN and PNP)	15 ft (4.5m)	0.1–10 ft (0.03–4.5m)	1 in (25 mm) diameter at 50 in (1.3m)	Visible red beam	4-pin micro DC connector	14101AQD07
Polarized reflex right-angle viewing ^{②③}	20–264 Vac 50/60 Hz or 15–30 Vdc (NPN)	10 ft (3m)	0.1–15 ft (0.03–4.5m)	1 in (25 mm) diameter at 50 in (1.3m)	Visible red beam	4-pin micro AC connector	14101RQD03
	15–30 Vdc	10 ft (3m)	0.1–15 ft (0.03–1.5m)	1 in (25 mm) diameter at 50 in (1.3m)	Visible red beam	4-pin micro DC connector	14101RQD07

Diffuse Reflective and Focused Diffuse Reflective Sensors

Description	Operating Voltage	Sensing Range ^④	Optimum Range	Field of View	Sensing Beam	Connection Type	Catalog Number
Three-Wire and Four-Wire Sensors							
Diffuse reflective forward viewing	20–264 Vac 50/60 Hz or 15–30 Vdc (NPN)	24 in (610 mm)	0.1–15 in (3–380 mm)	5 in (127 mm) diameter at 15 in (380 mm)	Infrared beam	4-pin micro AC connector	13100AQD03
	10–30 Vdc (NPN and PNP)						13100AQD07
Diffuse reflective right-angle viewing	20–264 Vac 50/60 Hz or 15–30 Vdc (NPN)	24 in (610 mm)	0.1–15 in (3–380 mm)	5 in (127 mm) diameter at 15 in (380 mm)	Infrared beam	4-pin micro AC connector	13100RQD03
	10–30 Vdc (NPN and PNP)						13100RQD07

Notes

- ① Ranges based on a 3 in diameter retroreflector.
- ② Polarized reflex sensors may not operate with retroreflective tape. Test selected tape prior to installation.
- ③ Right-angle viewing polarized reflex models are rated Type 1 only.
- ④ Sensor will detect a 90% reflective white card at this range.

Perfect Prox Background Rejection Sensor

Description	Operating Voltage	Nominal Range ^①	Optimum Range	Cutoff Range ^②	Field of View	Sensing Beam Type	Connection Type	Catalog Number
Three-Wire and Four-Wire Sensors								
Perfect Prox forward viewing	20–264 Vac 50/60 Hz or 15–30 Vdc (NPN)	2 in (50 mm) sharp cutoff	0.4–1.8 in (10–45 mm)	2.25 in (57 mm) and beyond	0.25 in (6 mm) diameter at 2.25 in (64 mm)	Visible red	4-pin micro AC connector	13104AQD03
		4 in (100 mm) sharp cutoff	0.5–3 in (13–76 mm)	5 in (127 mm) and beyond	0.35 in (9 mm) diameter at 5 in (127 mm)	Visible red		13101AQD03
	10–30 Vdc (NPN and PNP)	2 in (50 mm) sharp cutoff	0.4–1.8 in (10–45 mm)	2.25 in (57 mm) and beyond	0.25 in (6 mm) diameter at 2.25 in (64 mm)	Visible red	4-pin micro DC connector	13104AQD07
		4 in (100 mm) sharp cutoff	0.5–3 in (13–76 mm)	5 in (127 mm) and beyond	0.35 in (9 mm) diameter at 5 in (127 mm)	Visible red		13101AQD07
Perfect Prox right-angle viewing	20–264 Vac 50/60 Hz or 15–30 Vdc (NPN)	2 in (50 mm) sharp cutoff	0.4–1.8 in (10–45 mm)	2.25 in (57 mm) and beyond	0.25 in (6 mm) diameter at 2.25 in (64 mm)	Visible red	4-pin micro AC connector	13104RQD03
		4 in (100 mm) sharp cutoff	0.5–3 in (13–76 mm)	5 in (127 mm) and beyond	0.35 in (9 mm) diameter at 5 in (127 mm)	Visible red		13104RS5003
	10–30 Vdc (NPN and PNP)	2 in (50 mm) sharp cutoff	0.4–1.8 in (10–45 mm)	2.25 in (57 mm) and beyond	0.25 in (6 mm) diameter at 2.25 in (64 mm)	Visible red	4-pin micro DC connector	13104RQD07
		4 in (100 mm) sharp cutoff	0.5–3 in (13–76 mm)	5 in (127 mm) and beyond	0.35 in (9 mm) diameter at 5 in (127 mm)	Visible red		13104RS5007
Fine spot Perfect Prox forward viewing	20–264 Vac 50/60 Hz or 15–30 Vdc (NPN)	2 in (50 mm) sharp cutoff	0.9–1.8 in (23–45 mm)	2.25 in (57 mm) and beyond	0.05 in (1.3 mm) diameter at 1.7 in (43 mm)	Visible red	4-pin micro AC connector	13105AQD03
		10–30 Vdc (NPN and PNP)	2 in (50 mm) sharp cutoff	0.9–1.8 in (23–45 mm)	2.25 in (57 mm) and beyond	0.05 in (1.3 mm) diameter at 1.7 in (43 mm)		Visible red

Notes

- ① Sensor will detect a 90% reflectance card at this range.
 ② Sensor will ignore a 90% reflectance card at this range.

E58 Harsh-Duty Series**Features**

- Sensors are available in 18 mm and 30 mm diameters
- Refined optics provide long range detection through high levels of lens or airborne contamination
- Perfect Prox technology provides exceptional background rejection and extremely high excess gain
- Resistant to the wide range of chemicals used in the automotive, food processing and forest products industries
- Suitable for high-temperature, high-pressure washdown (1200 psi)
- Visible sensing beam on all models lets you see where the beam is aimed for quick setup and alignment
- Output status indicator is the brightest available and is visible from any angle and in any lighting condition

Product Selection**E58 Harsh-Duty Series****Thru-Beam and Reflex Sensors**

Description	Operating Voltage	Sensing Range	Optimum Range	Field of View	Thru-Beam Component	Connection Type	Catalog Number
Three-Wire and Four-Wire Sensors							
30 mm diameter thru-beam	20–132 Vac 50/60 Hz or 15–30 Vdc	800 ft (250m)	0.1–300 ft (0.03–90m)	33 in (830 mm) diameter at 25 ft (7.6m)	Source	4-pin micro AC connector	E58-30TS250-GAP
					Detector	4-pin micro AC connector	E58-30TD250-GDP
	10–30 Vdc	800 ft (250m)	0.1–300 ft (0.03–90m)	33 in (830 mm) diameter at 25 ft (7.6m)	Detector	4-pin micro DC connector	E58-30TD250-HDP
30 mm diameter reflex	20–132 Vac 50/60 Hz or 15–30 Vdc	59 ft (18m)	1–40 ft (0.03–12m)	6 in (150 mm) diameter at 20 ft (6m)	—	4-pin micro AC connector	E58-30RS18-GDP
					—	4-pin micro DC connector	E58-30RS18-HDP
30 mm diameter polarized reflex	20–132 Vac 50/60 Hz or 15–30 Vdc	34 ft (10m)	1–20 ft (0.03–6m)	6 in (150 mm) diameter at 20 ft (6m)	—	4-pin micro AC connector	E58-30RP10-GDP
					—	4-pin micro DC connector	E58-30RP10-HDP
	10–30 Vdc	34 ft (10m)	1–20 ft (0.03–6m)	6 in (150 mm) diameter at 20 ft (6m)	—	4-pin micro DC connector	E58-30RP10-HDP

Perfect Prox Background Rejection Sensors

Description	Operating Voltage	Nominal Range ^①	Optimum Range ^②	Cutoff Range	Field of View	Connection Type	Catalog Number
Two-Wire Sensors							
18 mm diameter Perfect Prox	90–132 Vac 50/60 Hz or 18–50 Vdc	4 in (100 mm)	0.5–3 in (13–76 mm)	5 in (127 mm) and beyond	0.38 in (10 mm) diameter at 4 in (100 mm)	2m cable	E58-18DP100-EL
Three-Wire and Four-Wire Sensors							
18 mm diameter Perfect Prox	10–30 Vdc	4 in (100 mm)	0.5–3 inches (13–76 mm)	5 in (127 mm) and beyond	0.38 in (10 mm) diameter at 4 in (100 mm)	4-pin micro DC connector	E58-18DP100-HLP
30 mm diameter Perfect Prox	20–132 Vac 50/60 Hz or 15–30 Vdc	11 in (280 mm)	1–9 in (26–228 mm)	12.5 in (318 mm)	1.0 in (26 mm) diameter at 11 in (280 mm)	4-pin micro AC connector	E58-30DPS280-GLP
	10–30 Vdc	11 in (280 mm)	1–9 in (26–228 mm)	12.5 in (318 mm)	1.0 in (26 mm) diameter at 11 in (280 mm)	4-pin micro DC connector	E58-30DPS280-HLP

Notes

- ① Sensor will detect a 90% reflectance card at this range.
 ② Sensor will ignore a 90% reflectance card at this range

Product Overview

Inductive Sensors Selection Guide



Description	iProx Page V9-T5-19	E57 Premium+ Series Page V9-T5-20	E57 Premium+ Series Short Barrel Page V9-T5-21
Overview	Standard features include extended sensing ranges, high noise-immunity, extreme durability and includes autoconfigure technology. Optional advanced features include output delay, speed detection and cloning with the ProxView Software	High-performance inductive sensors include stainless steel models, extended ranges and right-angle sensing	Full featured sensors with shorter overall length than standard tubular sensors
Applications	Automotive, machine tool, material handling where high sensing performance and inventory consolidation is a priority	A wide variety of applications, including those where customers require AC/DC universal inventory sensors	Automation, robotics, transfer lines, conveyors, material handling
Product features	Auto-configure technology automatically detects a sinking (NPN) or sourcing (PNP) connection and switches the sensor accordingly, without any user intervention Optional computer programming cable and windows-based ProxView configuration software makes it easy to customize sensors Clone the sensor to match the characteristics of more than 4,800 competitive models, or configure it to match your specific application needs	12, 18 and 30 mm diameters Two-wire and three-wire AC and DC sensors AC/DC models operate on 20–250 Vac or Vdc	Available in 12, 18 and 30 mm diameters Two-wire sensors offer 20–250 Vac or Vdc operation; AC only 20–135 Vac Three-wire models operate on 6–30 Vdc
Output ratings	AC—250–500 mA DC—300–500 mA	AC mode—250–500 mA DC mode—200 mA	AC—200–500 mA continuous DC—500 mA continuous
Enclosure ratings	Type 4, 4X, 6, 6P, 12, 13 IEC—IP67	Type 4, 4X, 6, 6P, 12, 13 IEC—IP67	Type 4, 4X, 6, 6P, 12, 13 IEC—IP67
Construction	Stainless steel	Stainless steel	Stainless steel Semi-shielded models: nickel-plated brass
Approvals	cUL listed	cUL listed	UL listed CSA certified

5.3

Sensors and Limit Switches

Inductive Sensors

Product Selection Guide, continued



5

Description	Global Proximity	E52 Cube Style
	Page V9-T5-22	Page V9-T5-23
Overview	This full-line, tubular proximity sensor family provides a cost-effective solution for high volume OEM use	A family of industry-standard, cube-sized inductive sensors with long range capabilities
Applications	Machine tool detection, press applications, cam detection, material handling, valve and shaft position, automotive assembly	Automotive, manufacturing, machinery OEMs
Product features	8, 12, 18 and 30 mm diameters Two-wire sensors available in AC or DC versions Three-wire sensors available in DC versions	Long inductive proximity ranges available (up to 40 mm sensing distance) Four-wire DC models have complementary outputs (1NO-1NC) Four-wire DC models use auto-configure technology, which allows the sensor to automatically adapt for NPN or PNP without user intervention
Output ratings	AC mode—200 mA DC mode—100 mA	AC—400 mA maximum DC—300 mA maximum
Enclosure ratings	IP67	Type 4, 4X, 6, 6P, 12, 13 IEC—IP67
Construction	Nickel-plated brass 8 mm nano stainless steel	Zinc alloy PPS, PL
Approvals	cCSAus	cULus

iProx



Features

- Available in AC two-wire, DC three-wire and unique DC four-wire with complementary (NO-NC) or dual NO outputs
- Auto-configure technology automatically detects a sinking (NPN) or sourcing (PNP) connection and switches the sensor accordingly, without any user intervention
- Reliably detect metal targets at ranges superior to conventional shielded or unshielded tubular sensors
- Quality construction using a stainless steel barrel, 360-degree dual-color LED indicator, Ryton® impact-resistant face cap and vibration-absorbing potting compound
- Resistant to extreme temperatures (–40°C)

Product Selection

iProx

iProx Sensors

Description	Operating Voltage	Sensing Range	Shielding	Connection Type	NO Output ^① Catalog Number
Three-Wire Sensors					
12 mm diameter	6–48 Vdc	4 mm	Shielded	4-pin micro DC connector	E59-M12A105D01-D1
		10 mm	Unshielded	4-pin micro DC connector	E59-M12C110D01-D1
18 mm diameter	6–48 Vdc	8 mm	Shielded	4-pin micro DC connector	E59-M18A108D01-D1
		18 mm	Unshielded	4-pin micro DC connector	E59-M18C116D01-D1
30 mm diameter	6–48 Vdc	15 mm	Shielded	4-pin micro DC connector	E59-M30A115D01-D1
		29 mm	Unshielded	4-pin micro DC connector	E59-M30C129D01-D1

iProx Complementary and Dual Output

Description	Operating Voltage	Sensing Range	Shielding	Output Type	Connection Type	Complementary Outputs (1NO-1NC) Catalog Number
Four-Wire Sensors						
12 mm diameter	6–48 Vdc	4 mm	Shielded	NPN (sinking)	4-pin micro DC connector	E59-M12A105D01-D3NN
				PNP (sourcing)	4-pin micro DC connector	E59-M12A105D01-D3PP
18 mm diameter	6–48 Vdc	18 mm	Unshielded	NPN (sinking)	4-pin micro DC connector	E59-M18C116D01-D3NN
				PNP (sourcing)	4-pin micro DC connector	E59-M18C116D01-D3PP

Note

① Sensors are ordered with pre-set outputs from the factory, but can be later programmed either NO or NC using ProxView software.

E57 Premium+ Series



Features

- High-performance inductive sensors include stainless steel models, extended ranges and right angle sensing
- New expanded offering of two-wire, three-wire, AC, DC, and AC/DC multiple range sensor models
- Designed with stainless steel barrel and new potting compound for robust, high-temperature, high-pressure washdown, as well as intense shock and vibration applications
- 360° output status indicator is visible from any angle and in any light condition
- Resettable short circuit protection and reverse polarity in select models
- Wide temperature range –13° to 158°F (–25° to 70°C) on cable, micro-style connections

Product Selection

E57 Premium+ Series

E57 Premium+ Series

Description	Operating Voltage	Sensing Range (Sn)	Shielding	Connection Type ①	NO Output Catalog Number
Three-Wire Sensors					
12 mm diameter end sensing	6–48 Vdc	2 mm (standard range)	Shielded (NPN)	4-pin micro DC connector	E57LAL12T110SD
		2 mm (standard range)	Shielded (PNP)	4-pin micro DC connector	E57LAL12T111SD
		4 mm (standard range)	Unshielded (NPN)	4-pin micro DC connector	E57LAL12T110ED
		4 mm (standard range)	Unshielded (PNP)	4-pin micro DC connector	E57LAL12T111ED
18 mm diameter end sensing	6–48 Vdc	5 mm (standard range)	Shielded (NPN)	4-pin micro DC connector	E57LAL18T110SD
		5 mm (standard range)	Shielded (PNP)	4-pin micro DC connector	E57LAL18T111SD
		8 mm (standard range)	Unshielded (NPN)	4-pin micro DC connector	E57LAL18T110ED
		8 mm (standard range)	Unshielded (PNP)	4-pin micro DC connector	E57LAL18T111ED
		20 mm (extended range)	Non-embeddable (PNP)	4-pin micro DC connector	E57-18LE20-BD
		5 mm	Shielded (PNP)	4-pin micro DC connector	E57RAL18T111SD
30 mm diameter end sensing	6–48 Vdc	10 mm (standard range)	Shielded (PNP)	4-pin micro DC connector	E57LAL30T111SD
		15 mm (standard range)	Unshielded (PNP)	4-pin micro DC connector	E57LAL30T111ED

Note

- ① For cable lengths longer than 2 meters, add the number of the desired length in meters to the end of the listed catalog number (for catalog numbers ending with a number, add an **S** and then the length). Examples for a 5-meter cable: E57-18LE12-A becomes E57-18LE12-A**5**; E57LAL12A2 becomes E57LAL12A2**S5**.

E57 Premium+ Series Short Barrel**Features**

- The same quality constructions of the E57 Premium+ standard models, but much shorter
- Designed with stainless steel barrel and impact-absorbing new potting compound for robust, high-temperature, high-pressure washdown, as well as intense shock and vibration applications
- 360° output status indicator is visible from any angle and in any light condition
- Resettable short circuit protection in AC/DC and DC models
- Reverse polarity protection in three-wire DC versions
- Small size to fit in tight spaces

Product Selection**E57 Premium+ Series Short Barrel****Short Barrel Length Proximity Sensors**

Description	Operating Voltage	Sensing Range (Sn)	Shielding	Connection Type ^①	NO Output Catalog Number
Three-Wire Sensors					
12 mm diameter	6–48 Vdc	2 mm	Shielded (NPN)	4-pin micro DC connector	E57SAL12T110SD
			Shielded (PNP)	4-pin micro DC connector	E57SAL12T111SD
		4 mm	Unshielded (NPN)	4-pin micro DC connector	E57SAL12T110ED
			Unshielded (PNP)	4-pin micro DC connector	E57SAL12T111ED
18 mm diameter	6–48 Vdc	5 mm	Shielded (NPN)	4-pin micro DC connector	E57SAL18T110SD
			Shielded (PNP)	4-pin micro DC connector	E57SAL18T111SD
		8 mm	Unshielded (NPN)	4-pin micro DC connector	E57SAL18T110ED
			Unshielded (PNP)	4-pin micro DC connector	E57SAL18T111ED
30 mm diameter	6–48 Vdc	10 mm	Shielded (NPN)	4-pin micro DC connector	E57SAL30T110SD
			Shielded (PNP)	4-pin micro DC connector	E57SAL30T111SD
		15 mm	Unshielded (NPN)	4-pin micro DC connector	E57SAL30T110ED
			Unshielded (PNP)	4-pin micro DC connector	E57SAL30T111ED

Note

- ^① Cable models are supplied as standard with a 2-meter cable. A 5-meter cable is available by adding **S5** to the catalog number.
Example: E57SAL12T110 becomes E57SAL12T110**S5**.

Global Proximity



Features

- Features solid performance and a basic feature set for reliable, cost-effective sensing
- Available in a variety of sizes to fit all applications: 8 mm, 12 mm, 18 mm and 30 mm diameters
- Operate on 10–30 Vdc in two-wire and three-wire (NPN or PNP) configurations
- Switching frequency of 2 kHz for DC models
- Shielded and unshielded versions available
- Terminations include 2m cable, micro-connector and nano-connector

Product Selection

Global Proximity

Global Proximity Sensors

Description	Operating Voltage	Sensing Range	Shielding	Output Type	Connection Type	Catalog Number
Three-Wire Sensors						
8 mm diameter	10–30 Vdc	3 mm (extended range)	Shielded	NO (NPN)	4-pin micro DC connector	E57-08GE03-CDB
				NO (PNP)	4-pin micro DC connector	E57-08GE03-GDB
		6 mm (extended range)	Unshielded	NO (NPN)	4-pin micro DC connector	E57-08GE06-CDB
				NO (PNP)	4-pin micro DC connector	E57-08GE06-GDB
12 mm diameter	10–30 Vdc	5 mm (extended range)	Shielded	NO (NPN)	4-pin micro DC connector	E57-12GE05-CDB
				NO (PNP)	4-pin micro DC connector	E57-12GE05-GDB
				NO (PNP)	4-pin micro DC connector	E57-12GE10-GDB
		10 mm (extended range)	Unshielded	NO (NPN)	4-pin micro DC connector	E57-12GE10-CDB
				NO (PNP)	4-pin micro DC connector	E57-12GE10-GDB
				NO (PNP)	4-pin micro DC connector	E57-12GE10-GDB
18 mm diameter	10–30 Vdc	8 mm (extended range)	Shielded	NO (NPN)	4-pin micro DC connector	E57-18GE08-CDB
				NO (PNP)	4-pin micro DC connector	E57-18GE08-GDB
				NO (PNP)	4-pin micro DC connector	E57-18GE18-GDB
		18 mm (extended range)	Unshielded	NO (NPN)	4-pin micro DC connector	E57-18GE18-CDB
				NO (PNP)	4-pin micro DC connector	E57-18GE18-GDB
				NO (PNP)	4-pin micro DC connector	E57-18GE18-GDB
30 mm diameter	10–30 Vdc	15 mm (extended range)	Shielded	NO (NPN)	4-pin micro DC connector	E57-30GE15-CDB
				NO (PNP)	4-pin micro DC connector	E57-30GE15-GDB
				NO (PNP)	4-pin micro DC connector	E57-30GE29-GDB
		29 mm (extended range)	Unshielded	NO (NPN)	4-pin micro DC connector	E57-30GE29-CDB
				NO (PNP)	4-pin micro DC connector	E57-30GE29-GDB
				NO (PNP)	4-pin micro DC connector	E57-30GE29-GDB

E52 Cube**Features**

- Rugged inductive sensors in industry-standard cube package
- Long inductive proximity ranges available (up to 40 mm sensing distance)
- Four-wire DC models have complementary outputs (1NO-1NC)
- Four-wire DC models use auto-configure technology, which allows the sensor to automatically adapt for NPN or PNP without user intervention
- Robust design featuring vibration and impact-absorbing potting compound
- Ideal for extreme temperatures or high-pressure washdown environments

Product Selection

Note: Micro-connector models shown; mini-connector models also available.

E52 Cube Style**E52 Cube Inductive Proximity Sensors**

Description	Voltage Type	Output Configuration	Shielding	Output Type	Sensing Range	Connector Style	Catalog Number
DC Four-Wire Sensors							
Cube package (40 x 40 x 40 mm)	10–48 Vdc	NPN/PNP autoconfigure ①	Shielded	1NO-1NC	15 mm	DC 4-pin micro	E52Q-DL15SAD01
			Unshielded	1NO-1NC	15 mm	DC 4-pin micro	E52Q-DL15UAD01
			Shielded	1NO-1NC	20 mm	DC 4-pin micro	E52Q-DL20SAD01
			Unshielded	1NO-1NC	20 mm	DC 4-pin micro	E52Q-DL20UAD01
			Unshielded	1NO-1NC	25 mm	DC 4-pin micro	E52Q-DL25UAD01
			Unshielded	1NO-1NC	30 mm	DC 4-pin micro	E52Q-DL30UAD01
			Unshielded	1NO-1NC	35 mm	DC 4-pin micro	E52Q-DL35UAD01
			Unshielded	1NO-1NC	40 mm	DC 4-pin micro	E52Q-DL40UAD01

Note

① Autoconfigure technology allows the sensor to automatically adapt to NPN or PNP without user intervention.

Product Overview

Connectivity Selection Guide



5

Description	Global Plus Connector Cables
	Page V9-T5-25
Overview	Includes a wide variety of single- and double-connector cables in a variety of sizes (mini, micro, nano), lengths and jacket materials to fit any application
Sensing types and ranges	Nano (M8) Micro (M12) Mini
Product features	Industry standard connector types Industrial-duty polymer jackets consisting of PVC, PUR, or irradiated PUR Stranded copper conductors and polymer jackets provide a high resistance to bending motions Right angle units for applications that have constricted space
Enclosure ratings	Type 6P, IP68
Approvals	UL, cUL, CSA

Global Plus Connector Cables



Features

- Cost effective and reliable quick-disconnect cables
- A wide variety of single- and double-connector cables available
- Custom lengths are available upon request from the factory
- A full offering of nano, micro and mini connector cables in a variety of lengths and jacket materials available
- Field wireable accessories
- Straight and right-angle connector ends

Catalog Number Selection

Global Plus Connector Cables





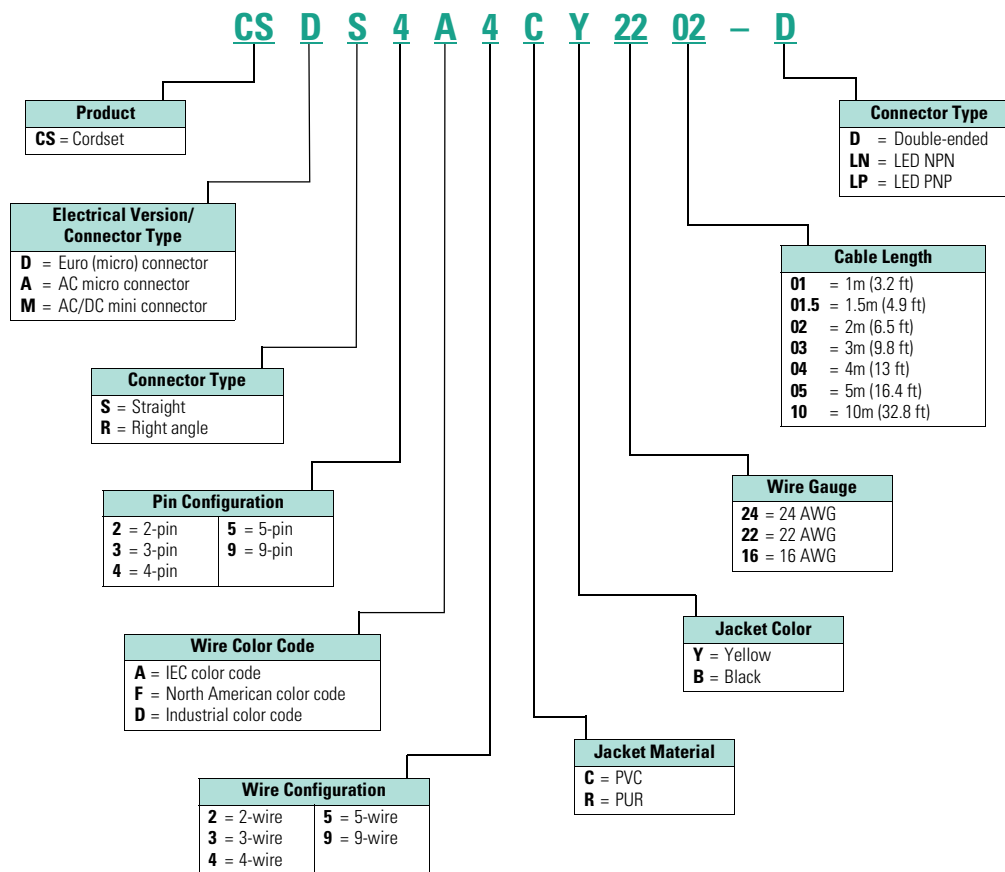

Global Plus

Note: This is a representative guide to the catalog numbering system. All possible combinations may not be available for ordering.





Product Selection



Micro Style, Single-Connector Cables

Description	Voltage Style	Number of Pins	Gauge	Length	PVC Jacket Catalog Number	Pin Configuration/Wire Colors (Face View Female Shown)
Standard Cables						
Micro style straight female	DC	4-pin 3-wire	22 AWG	6 ft (2m)	CSDS4A3CY2202	 1-Brown 2-No wire 3-Blue 4-Black
		4-pin 4-wire	22 AWG	6 ft (2m)	CSDS4A4CY2202	 1-Brown 2-White 3-Blue 4-Black
		5-pin 5-wire	22 AWG	6 ft (2m)	CSDS5A5CY2202	 1-Brown 2-White 3-Blue 4-Black 5-Green/yellow
Micro style straight female	DC	4-pin 3-wire	22 AWG	6 ft (2m)	CSDR4A3CY2202	 1-Brown 2-No wire 3-Blue 4-Black
		4-pin 4-wire	22 AWG	6 ft (2m)	CSDR4A4CY2202	 1-Brown 2-White 3-Blue 4-Black
		5-pin 5-wire	22 AWG	6 ft (2m)	CSDR5A5CY2202	 1-Brown 2-White 3-Blue 4-Black 5-Green/yellow

Mini Style, Single-Connector Cables

Description	Voltage Style	Number of Pins	Gauge	Length	PVC Jacket Catalog Number	Pin Configuration/Wire Colors (Face View Female Shown)
Standard Cables						
Mini style straight female	AC/DC	4-pin 4-wire	16 AWG	6 ft (2m)	CSMS4A4CY1602	 1-Black 2-Blue 3-Brown 4-White
	AC/DC	4-pin 5-wire	16 AWG	6 ft (2m)	CSMS5D5CY1602	 1-White 2-Red 3-Green 4-Orange 5-Black

Nano Style, Single-Connector Cables

Description	Voltage Style	Number of Pins	Gauge	Length	PVC Jacket Catalog Number	Pin Configuration/Wire Colors (Face View Female Shown)
Standard Cables						
Nano style straight female	—	3-pin 3-wire	24 AWG	6 ft (2m)	CSNS3A3CY2402	 1-Brown 2-Blue 3-Black
Nano style right angle female	—	3-pin 3-wire	24 AWG	6 ft (2m)	CSNR3A3CY2402	 1-Brown 2-Blue 3-Black

Micro and Mini Style, Double-Ended Connector Cables

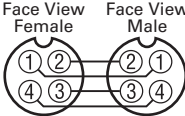
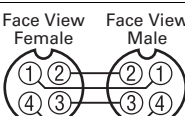
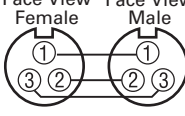
Description	Voltage Style	Number of Pins	Gauge	Length	PVC Jacket Catalog Number	Pin Configuration/Wire Colors (Face View Female Shown)
Standard Cables						
Micro style straight female/male	DC	4-pin	22 AWG	6 ft (2m)	CSDS4A4CY2202-D	
Micro style straight female/ right angle male	DC	4-pin	22 AWG	6 ft (2m)	CSDR4A4CY2202-D	
Mini style straight female/male	AC/DC	3-pin	16 AWG	6 ft (2m)	CSMS3F3CY1602-DP	

Modular Bus System



General Purpose Transformer



PSG Power Supplies



CHDB Series Power Distribution



XB Terminal Blocks



6.1	Modular Bus System for Hydraulic Magnetic Circuit Breakers	
	Product Overview	V9-T6-2
	MDBS	V9-T6-3
	PDMB	V9-T6-4
6.2	General Purpose and Industrial Control Transformers	
	Product Overview	V9-T6-5
	General Purpose Transformers	V9-T6-6
	Industrial Control Transformers	V9-T6-8
6.3	Power Supplies	
	Product Overview	V9-T6-10
	PSG Power Supplies	V9-T6-11
	ELC Power Supplies	V9-T6-12
6.4	Power Distribution Blocks	
	Product Overview	V9-T6-13
	CHDB Series—Power Distribution Blocks, Enclosed and Open	V9-T6-14
	CH160 Series—Power Terminal Blocks	V9-T6-15
6.5	Terminal Blocks and Accessories	
	Product Overview	V9-T6-16
	XB Series IEC Terminal Blocks	V9-T6-17

For our complete product offering, see Volume 7—Logic Control, Operator Interface and Connectivity Solutions, CA08100008E

Product Overview

Modular Bus System Selection Guide



6

Description	Modular Distribution Busbar System (MDBS) Page V9-T6-3	Power Distribution Busbar Module (PDBM) Page V9-T6-4
Technical Data		
Voltage		
Type	AC or DC or both	DC
Vdc	to 110 Vdc nominal (77–137.5 Vdc)	to 72 Vdc nominal (55–90 Vdc)
Vac	to 380 Vac nominal (342–424 Vac); 50/60 Hz	—
Busbars	4 busbars	1, additional negative return busbar possible
Busbar rating	300A output	100A total output (up to 30A per breaker)
Mounting	Front panel	Front or rear panel
Breaker specifications		
Type	Hydraulic-magnetic	Hydraulic-magnetic
Series	AMR, AM1P (three-pole AMR in parallel)	J Series
Ratings	to 100A (single-pole), 300A (three-pole)	to 30A
Terminals	Plug-in bullet terminals	Fast-on
Number of breakers	3 and 5 breaker modules (any combination)	Maximum 12 positions (using 4-position modules)
Auxiliary contact	Via individual connections via trim trio connector	Individual signals via SMS, SUBD, or DT connectors
Dual control	Available	Available
Dimensions		
Module only—H x W x D in (mm)		
3-Breaker	3.31 x 2.25 x 4.095 (84 x 57.15 x 104)	—
4-Breaker	—	3.94 x 3.00 x 1.10 (100 x 76 x 28)
5-Breaker	3.31 x 3.74 x 4.095 (84 x 95 x 104)	—
Module including mounting blade, busbar, auxiliary switch— H x W x D in (mm)		
3-Breaker	4.53 x 2.25 x 5.52 (115 x 57.15 x 140)	—
4-Breaker	—	3.94 x 3.00 x 1.46 (100 x 76 x 37)
5-Breaker	4.53 x 3.74 x 5.52 (84 x 95 x 104)	—
Weight		
Weight (without busbars)		
3-Breaker	200g (7 oz)	—
4-Breaker ①	—	160g (5.65 oz)
5-Breaker	300g (10.6 oz)	—

Note

① With busbars.

Modular Bus System for Hydraulic Magnetic Circuit Breakers

Modular Bus System for Hydraulic Magnetic Circuit Breakers—MDBS



Features

- Compact power distribution bus system design
- Number, type (AC vs. DC) and location of loads can be easily changed by adjusting the busbar components
- Saves installation time
- Available with or without individual alarm auxiliary switches
- Utilizes pluggable breakers for quick connection and ability to disconnect

Catalog Number Selection

Modular Bus System for Hydraulic Magnetic Circuit Breakers—MDBS

Modular Bus System—MDBS Model

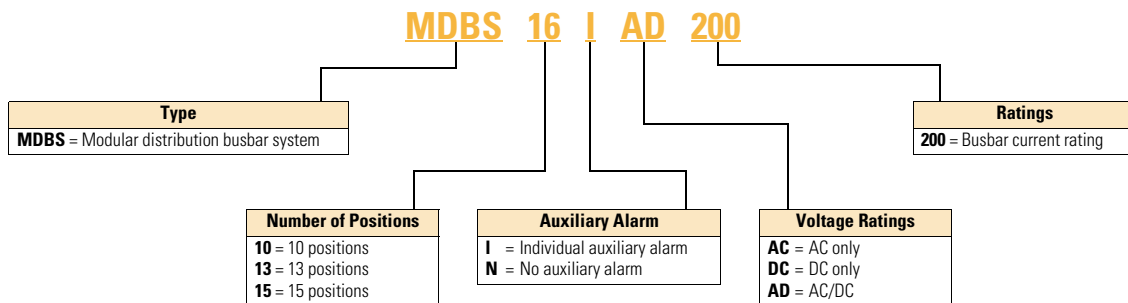

Product Selection

Modular Bus System—MDBS Model

Individual Auxiliary Alarm	Voltage	Number of Breaker Positions (Poles)	Catalog Number ^①
Yes	AC and DC	10	MDBS-10-1-AD-200
		13	MDBS-13-1-AD-200
		15	MDBS-15-1-AD-200
No	AC only	10	MDBS-10-N-AD-200
		13	MDBS-13-N-AD-200
		15	MDBS-15-N-AD-200

Note

- ^① These are typical catalog numbers that could be built using the modular system. Products are built-to-order according to specifications and can be provided with any number of positions.

6.1

Machine Integration

Modular Bus System for Hydraulic Magnetic Circuit Breakers

Modular Bus System for Hydraulic Magnetic Circuit Breakers—PDMB



6

Features

- Compact power distribution bus system design
- Number, type (AC vs. DC) and location of loads can be easily changed by adjusting the busbar components
- Saves installation time
- Available with or without individual alarm auxiliary switches
- Utilizes pluggable breakers for quick connection and ability to disconnect

Catalog Number Selection

Modular Bus System for Hydraulic Magnetic Circuit Breakers—PDMB

Modular Bus System—PDMB Model

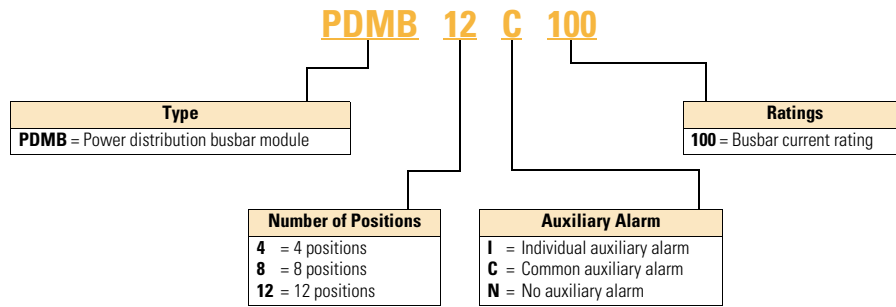

Product Selection

Modular Bus System—PDMB Model

Auxiliary Alarm	Busbar Current Rating	Number of Breaker Positions (Poles)	Catalog Number ①
Common	100A	4	PDMB-4-C-100
		8	PDMB-8-C-100
		12	PDMB-12-C-100
Individual	100A	4	PDMB-4-1-100
		8	PDMB-8-1-100
		12	PDMB-12-1-100
No auxiliary alarm	100A	4	PDMB-4-N-100
		8	PDMB-8-N-100
		12	PDMB-12-N-100

Note

① These are typical catalog numbers that could be built using the modular system. Products are built-to-order according to specifications and can be provided with any number of positions.

Product Overview

General Purpose and Industrial Control Transformers Selection Guide



Description	General Purpose Transformers	Industrial Control Transformers
	Page V9-T6-6	Page V9-T6-8
General applications	Typically used to step-down voltage from a high voltage to a lower, safer voltage. Commonly installed in or on other electrical equipment, such as machinery, switchboards, and motor control centers. Also installed as loose equipment.	Typically used to step-down voltage to a level suitable to operate a variety of electrically controlled devices. Must be installed inside an enclosure, panel, or other structure to provide protection from the surroundings.
Maximum primary voltage rating	600 Vac	600 Vac
Frequency	60 Hz standard (50/60 Hz optional)	50/60 Hz
Enclosure rating	Type 3R raintight	Open
Insulation system	180°C (356°F)	105°C (221°F)/130°C (266°F)/180°C (356°F)
Temperature rise		
Standard	115°C (239°F)	55°C (131°F)/80°C (176°F)/120°C (248°F)
Optional	80°C (176°F)	—
Approvals	UL® 506, UL 1561, CSA® C22.2	UL 506, CSA C22.2
Ratings		
50 VA	37.5 kVA single-phase	50 to 5,000 VA
3 kVA	75 kVA three-phase	—

General Purpose Transformers



6

Features

- Totally enclosed non-ventilated Type 3R enclosure
- 180°C insulation system
- Suitable for indoor or outdoor applications
- UL listed and CSA certified

Catalog Number Selection

General Purpose Transformers

General Purpose

T S 20 N 11 S 05 A

Prefix Options	
C	= CSA labeled ventilated transformer
Marine Duty	
QS	= EPM marine (1-Ph encapsulated)
LY	= EPTM Marine (3-Ph encapsulated)
RT	= DS-3M marine (1-Ph ventilated)
MV	= DT-3M marine (3-Ph ventilated)

Type	
S	= EP (single-phase encapsulated)
Y	= EPT (three-phase encapsulated)
T	= DS-3 (single-phase ventilated)
V	= DT-3 (three-phase ventilated)
P	= Mini-power center
Z	= Class 1 Division 2 Groups C and D
X	= Harmonic mitigating (three-phase ventilated)

Nonlinear (three-phase ventilated)		Nonlinear (single-phase ventilated)	
H = KT-4	J = KT-30	HT = KT-4	
B = KT-9	A = KT-40	NT = KT-13	
N = KT-13	K = KT-50	GT = KT-20	
G = KT-20			

Taps	
D	= 2 at +2.5%, 2 at -2.5%
E	= 1 at +5%, 1 at -5%
F	= 1 at -10%
G	= 2 at -5%
J	= 4 at -2.5%
K	= 1 at -10% x 2 at -5%
L	= 2 at -5% x 4 at -2.5%
M	= 2 at +2.5%, 4 at -2.5%
N	= None
R	= 1 at +5%, 2 at -5%
P	= 1 at +5%, 2 at -5% x 2 at +2.5%, 4 at -2.5%
T	= 1 at +4.2%, 1 at -4.2%
U	= 1 at +2.5%, 3 at -2.5%
W	= 1 at +3.5%, 1 at -3.5%
X	= 2 at +3.1%, 2 at -3.1%

kVA		
81 = 0.05	07 = 7.5	12 = 112.5
85 = 0.075	09 = 9	49 = 150
82 = 0.10	10 = 10	67 = 167
83 = 0.15	15 = 15	22 = 225
26 = 0.25	21 = 22.5	52 = 250
51 = 0.50	25 = 25	33 = 300
76 = 0.75	30 = 30	54 = 333
01 = 1	37 = 37.5	55 = 500
16 = 1.5	45 = 45	60 = 600
02 = 2	50 = 50	77 = 750
03 = 3	75 = 75	11 = 1000
05 = 5	99 = 100	14 = 1500
06 = 6		

Suffix Options	
A...Y = ①	SR = ⑩
CU = ②	CE = ⑪
SS = ③	T = ⑫
ZZ = ④	EE = ⑬
NV = ⑤	NON = ⑭
X = ⑥	POS = ⑮
LS_ = ⑦	NEG = ⑯
AF = ⑧	THR = ⑰
TR = ⑨	

Phase		
A = Buck and boost	F = 115°C rise	S = Single
B = 80°C rise	E = Electrostatic shield	T = Three

Primary Voltage			
13 = 110 x 220	23 = 230	43 = 416	42 = 2400
12 = 120	24 = 240	44 = 440	46 = 4160
10 = 120 x 240	20 = 240 x 480	45 = 450	49 = 4800
29 = 208	27 = 277	48 = 480	40 = Export model
72 = 200	38 = 380	57 = 575	54 = 120/208/240/277
25 = 220	39 = 400	60 = 600	

Secondary Voltage			
04 = 12/24	28 = 208Y/120	21 = 240/480	48 = 480 delta
06 = 16/32	29 = 208	27 = 277	60 = 600 delta
08 = 24/48	25 = 220 delta	38 = 380 delta	61 = 600Y/346
14 = 110/220	31 = 220Y/127	37 = 380Y/220	42 = 2400
12 = 120	26 = 220 delta/110 midtap	34 = 400Y/231	41 = 4160Y/2400
10 = 120 x 240	22 = 240 delta/120 midtap	51 = 416Y/240	46 = 4160
11 = 120/240	64 = 240Y/139	35 = 440Y/254	49 = 4800
54 = 127/254	24 = 240 delta	62 = 460Y/266	
19 = 190Y/110	20 = 240 x 480	47 = 480Y/277	

Notes

- Model number is not used on newly designed/redesigned transformers.
- Copper windings.
- Stainless steel enclosure (uses 316 stainless steel, does not imply a NEMA 4X rating).
- Open type core and coil assembly.
- Totally enclosed non-ventilated DS-3 or DT-3.
- 50/60 Hz.
- Low sound design. LS47 indicates low sound equal to 47 dB; LS42 indicates 42 dB.
- Fungus proof.
- Certified test report of standard production tests for the specific serial number to be shipped.
- Certified sound level report.
- CE Marked.
- Thermal indicator embedded in center coil. Suffix "TT" indicates two thermal indicators of different temperature ratings, are installed.
- NEMA TP-1 Energy Star energy efficient.
- 0° phase-shift (used with HMTs).
- +15° phase-shift (used with HMTs).
- 15° phase-shift (used with HMTs).
- 30° phase-shift (used with HMTs).

Product Selection

Single-Phase Encapsulated, 240 x 480—120/240, 115°C Rise

kVA	Catalog Number	Outline #	Wiring Diagram
0.05	S20N11S81N	52	3A
0.075	S20N11S85N	53	3A
0.1	S20N11S82N	54	3A
0.15	S20N11S83N	55	3A
0.25	S20N11S26N	56	3A
0.5	S20N11S51N	57	3A
0.75	S20N11S76N	58A	3A
1	S20N11S01N	59A	3A
1.5	S20N11S16N	67	3A
2	S20N11S02N	68	3A
3	S20N11S03N	176	3A
5	S20N11S05N	177	3A
7.5	S20N11S07N	178	3A
10	S20N11S10N	179	3A
15	S20N11S15N	180	3A
25	S20L11S25N	182	23A
37.5	S20L11S37	300A	248A

Single-Phase Transformer Sizing Chart

Line current = (kVA x 1000)/line voltage.

kVA	Rated Line Voltage								
	120	208	240	277	480	600	2400	4160	4800
0.5	4.2	2.4	2.1	1.8	1	0.8	0.2	0.1	0.1
1	8.3	4.8	4.2	3.6	2.1	1.7	0.4	0.2	0.2
1.5	12.5	7.2	6.3	5.4	3.1	2.5	0.6	0.4	0.3
2	16.7	9.6	8.3	7.2	4.2	3.3	0.8	0.5	0.4
3	25	14.4	12.5	10.8	6.3	5	1.3	0.7	0.6
5	41.7	24	20.8	18.1	10.4	8.3	2.1	1.2	1
7.5	62.5	36.1	31.3	27.1	15.6	12.5	3.1	1.8	1.6
10	83.3	48.1	41.7	36.1	20.8	16.7	4.2	2.4	2.1
15	125	72.1	62.5	54.2	31.3	25	6.3	3.6	3.1
25	208.3	120.2	104.2	90.3	52.1	41.7	10.4	6	5.2
37.5	312.5	180.3	156.3	135.4	78.1	62.5	15.6	9	7.8
50	416.7	240.4	208.3	180.5	104.2	83.3	20.8	12	10.4
75	625	360.6	312.5	270.8	156.3	125	31.3	18	15.6
100	833.3	480.8	416.7	361	208.3	166.7	41.7	24	20.8
167	1391.7	802.9	695.8	602.9	347.9	278.3	69.6	40.1	34.8
250	2083.3	1201.9	1041.7	902.5	520.8	416.7	104.2	60.1	52.1
333	2775	1601	1387.5	1202.2	693.8	555	138.8	80	69.4

Industrial Control Transformers



Features

- Epoxy encapsulated
- 130°C insulation system
- 50/60 Hz operation
- UL listed and CSA certified

Catalog Number Selection

Industrial Control Transformers

Industrial Control

CE 0250 E 2F CE

Type	
C	= Industrial control transformer
CE	= CE Marked control transformer

VA Rating	
0025 = 25	1000 = 1000
0050 = 50	1500 = 1500
0075 = 75	2000 = 2000
0100 = 100	3000 = 3000
0150 = 150	5000 = 5000
0200 = 200	Type AP Only:
0250 = 250	0003 = 3000
0300 = 300	0005 = 5000
0350 = 350	0007 = 7500
0500 = 500	0010 = 10000
0750 = 750	0015 = 15000

Transformer Design	
E	= MTE
K	= MTK
P	= AP

	Voltage	
	Primary	Secondary
AC	= 380 x 415	24
AG	= 208/240/277/380/480	24
1B	= 120 x 240	24
2A	= 240 x 480, 230 x 460, 220 x 440	120/115/110
2B	= 240 x 480	24
2C	= 240 x 480	120 x 240
2F	= 230/460	115
2G	= 230/460	115/230
2U	= 220/380/440/550, 230/400/460/575, 240/416/480/600	23/110, 24/115, 25/120
2V	= 208/230/400/460/575	24/115/230
2W	= 208/230/400/460/575	115/230
3A	= 208/277	120
3B	= 115	24
3C	= 230/460/575	115/95
3D	= 208/380/416	115/95
4B	= 208/230/460/575	24
4C	= 550/575/600	110/115/120
4D	= 380/400/415	110 x 220
4E	= 208/230/460/575	115
4H	= 380/400/415	22/23/24
4W	= 550/575/600	22/23/24
5E	= 200/220/440, 208/230/460, 240/480	23/110, 24/115, 25/120
6U	= 240/416/480/600, 230/400/460/575, 220/380/440/550, 208/500	99/120/130, 95/115/125, 91/110/120, 85/100/110
7G ①	= 240 x 480	120/240

Modifications	
Type MTE/MTK	
CE	= CE marked control transformer
FB	= Factory-mounted two-pole primary fuse block for rejection type fuses
FBN	= Factory-mounted two-pole primary fuse block for non-rejection type fuses
Q	= Secondary fuse clips for 1/4 x 1-1/4 in fuses
XX	= No secondary fuse clips
RT	= Ring type terminals for connection to fuse block
ES	= Electrostatic shield
FS	= Factory-mounted finger-safe terminal shields
Type AP	
B	= Bottom mounted
S	= Side/wall mounted
ES	= Electrostatic shield
CU	= Copper windings
Type MTA/MTC	
FB	= Factory-mounted three-pole fuse block (two-pole primary rejection type with single-pole secondary non-rejection type)
ES	= Electrostatic shield
L	= Lead terminations

Note

① Type AP only.

Product Selection**Primary 240 x 480,
230 x 460, 220 x 440—
Secondary 120/115/110**

VA	Catalog Number
25	C0025E2A
50	C0050E2A
75	C0075E2A
100	C0100E2A
150	C0150E2A
200	C0200E2A
250	C0250E2A
300	C0300E2A
350	C0350E2A
500	C0500E2A
750	C0750E2A
1000	C1000E2A
1500	C1500E2A

**Primary 240 x 480—
Secondary 24**

VA	Catalog Number
50	C0050E2B
75	C0075E2B
100	C0100E2B
150	C0150E2B
200	C0200E2B
250	C0250E2B
300	C0300E2B
350	C0350E2B
500	C0500E2B
750	C0750E2B

**Primary 120 x 240—
Secondary 24**

VA	Catalog Number
50	C0050E1B
75	C0075E1B
100	C0100E1B
150	C0150E1B
200	C0200E1B
250	C0250E1B
300	C0300E1B
350	C0350E1B
500	C0500E1B

Product Overview

Power Supplies Selection Guide

6



Description	PSG Power Supplies Page V9-T6-11	ELC Power Supplies Page V9-T6-12
Technical Data		
Output voltage	24 Vdc	24 Vdc
Input voltage	100–240 Vac/120–375 Vdc or 400–500 Vac/450–800 Vdc	100–240 Vac
Mounting	DIN rail	DIN rail/panel
Outrush current (current boost/surge)	150% of nominal	110% of nominal
Class 1, Division 2	Yes	Yes
Semi 47 approved	Yes	—
Housing material	Metal	Plastic
Adjustable output voltage	22–28 Vdc	—
Redundancy allowed	Yes	—
Connection	Large screw terminals	Large screw terminals
Overload/short circuit protection	Yes	Yes

PSG Power Supplies



Features

- Universal input voltages:
 - 100–240 Vac for single-phase units, 400–500 Vac for three-phase units
- Rugged aluminum housing stands up to harsh environments
- Compact size, with common depth and height across all models allows for common panel depths and family consistency
- Heavy-duty screw terminals with finger-safe protective cover allow use of ring-lug terminals
- Class 1, Division 2 hazardous location rated

Catalog Number Selection

PSG Power Supplies

PSG

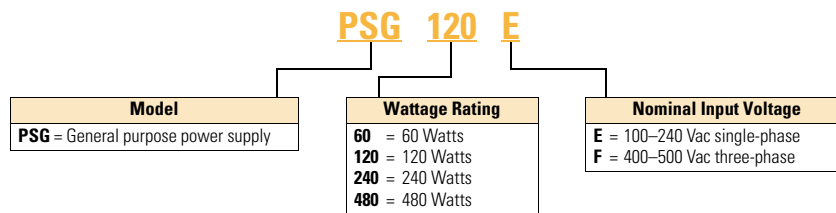

Product Selection

Semi F47 Certified for Voltage Sag Immunity PSG Power Supply

Description	Catalog Number
Single-phase 100–240 Vac input, 24 Vdc/2.5A output	PSG60E
Three-phase 400–500 Vac input, 24 Vdc/2.5A output	PSG60F
Single-phase 100–240 Vac input, 24 Vdc/2.5A output	PSG120E
Three-phase 400–500 Vac input, 24 Vdc/2.5A output	PSG120F
Single-phase 100–240 Vac input, 24 Vdc/2.5A output	PSG240E
Three-phase 400–500 Vac input, 24 Vdc/2.5A output	PSG240F
Single-phase 100–240 Vac input, 24 Vdc/2.5A output	PSG480E
Three-phase 400–500 Vac input, 24 Vdc/2.5A output	PSG480F

ELC Power Supplies



Features

- Compact and low-cost source for 24 Vdc power
- Universal input voltage: 100–240 Vac
- Compact size, with common depth and height across models allows for common panel depths and family consistency
- Power On indication LED
- Integrated mounting hardware for panel mounting or DIN rail mounting

6

Product Selection

ELC Power Supplies

ELC

Description	Catalog Number
24W, 1A power supply	ELC-PS01
48W, 2A power supply	ELC-PS02

Product Overview

Power Distribution Blocks Selection Guide



Description	CHDB Series (Open Style) Page V9-T6-14	CHDB Series (Enclosed Style) Page V9-T6-14	CH160 Series Page V9-T6-15
UL listing	UL 1953 for feeder circuits	UL 1953 for feeder circuits	UL 1059 for branch circuits
Protection degree	N/A—covers available	IP20 finger-safe	N/A—covers available
Number of poles	3	1	1, 2 or 3
Maximum current	310A	570A	840A
High SCCR	Yes	Yes	No

CHDB Series—Power Distribution Blocks, Enclosed and Open



6

Features

- High short-circuit current rating (SCCR) applications up to 200,000 amperes
- 600 Vac or Vdc (UL 1953), 690 Vac or Vdc
- DIN rail or panel mount (CHDB330F is panel mount only)
- Captive termination screws prevent lost screws
- Single-pole, gang mountable for multi-pole applications
- UL listed 1953, guide QPQS, file E256146
- CSA certified, class 6228-01, file 15364 (enclosed style)
- CE component IEC 60947-7-1 (enclosed style)
- IEC 60529, IP20 (finger-safe) under specific wiring conditions (enclosed style)

Product Selection

CHDB Series—Power Distribution Blocks, Enclosed and Open

CHDB Series

Line Connection	Load Connection	Configuration	Amperes	Style	Poles	Catalog Number
2/0–#8 AWG	(4) #4–#14 AWG		175	Open	3	CHDB2203
2/0–#8 AWG	(6) #4–#14 AWG		175	Open	3	CHDB3213
300 kcmil–#4 AWG	(6) #4–#12 AWG		310	Open	3	CHDB3233
300 kcmil–#4 AWG	(12) #4–#14 AWG		310	Open	3	CHDB3703
300 kcmil–#4 AWG	(6) #2–#12 AWG		310	Open	3	CHDB3713
	(3) 1/0–#12 AWG		310	Open	3	CHDB3713
2/0–#8 AWG	2/0–#8 AWG		175	Enclosed ^①	1	CHDB204F
500 kcmil–#6 AWG	(6) #2–#14 AWG		380	Enclosed ^①	1	CHDB330F
300 kcmil–#4 AWG	(12) #4–#14 AWG		570	Enclosed ^①	1	CHDB377F

Note

^① Finger-safe.

CH160 Series—Power Terminal Blocks**Features**

- Ratings to 840A, 600V
- Molded material, black; UL rated 94V-0 thermoplastic
- Operating temperature: 302°F (150°C)
- Optional cover
- UL recognized
- CSA certified

Product Selection**CH160 Series—Power Terminal Blocks****CH160 Series**

Line Connection	Load Connection	Connector Material and Ampacity	Catalog Number ^①
CH162 Series			
#2-#14 Cu/#8 Al	#2-#14 Cu/#8 Al	Al 115A	CH16200_
1/0-#14 Cu	1/0-#14 Cu	Cu 150A	CH16201_
2/0-#8 Cu/Al	2/0-#8 Cu/Al	Al 175A	CH16204_
2/0-#14 Cu/#8 Al	(4) #4-#14 Cu/#8 Al	Al 175A	CH16220_
CH163 Series			
250 MCM-#6 Cu	250 MCM-#6 Cu	Cu 255A	CH16301_
350 MCM-#6 Cu/Al	350 MCM-#6 Cu/Al	Al 310A	CH16303_
500 MCM-#6 Cu/Al	500 MCM-#6 Cu/Al	Al 380A	CH16306_
2/0-#14 Cu/Al	(6) #4-#14 Cu/#8 Al	Al 175A	CH16321_
350 MCM-#6 Cu/Al	(6) #4-#14 Cu/#8 Al	Al 310A	CH16323_
(2) 2/0-#14 Cu/#8 Al	(6) #4-#14 Cu/#8 Al	Al 350A	CH16325_
500 MCM-#6 Cu/Al	(6) #2-#14 Cu/#8 Al	Al 380A	CH16330_
350 MCM-#6 Cu/Al	(3) #2-#14 Cu/#8 Al	Al 310A	CH16332_
	(2) 1/0-#14 Cu/#8 Al	Al 310A	CH16332_
350 MCM-#6 Cu/Al	(12) #4-#14 Cu/#8 Al	Al 310A	CH16370_
350 MCM-#6 Cu/Al	(6) #2-#14 Cu/#8 Al	Al 310A	CH16371_
	(3) 1/0-#14 Cu/#8 Al	Al 310A	CH16371_
350 MCM-#6 Cu/Al	(21) #10-#14 Cu/#10 Al	Al 310A	CH16372_
350 MCM-#6 Cu/Al	(3) 1/0-#14 Cu/#8 Al	Al 310A	CH16373_
	(14) #10-#14 Cu/#8 Al	Al 310A	CH16373_
600 MCM-#2 Cu/Al	(12) #4-#14 Cu/#8 Al	Al 420A	CH16375_
600 MCM-#2 Cu/Al	(6) #2-#14 Cu/#8 Al	Al 420A	CH16376_
	(3) 1/0-#14 Cu/#8 Al	Al 420A	CH16376_
CH165 Series			
(2) 350 MCM-4 Cu/Al	(2) 350 MCM-4 Cu/Al	Al 620A	CH16500_
(2) 500 MCM-#6 Cu/Al	(2) 500 MCM-#6 Cu/Al	Al 760A	CH16504_
(2) 600 MCM-#2 Cu/Al	(4) 3/0-#8 Cu/Al	Al 840A	CH16528_
	(4) #4-#14 Cu/#8 Al	Al 840A	CH16528_
(2) 500 MCM-#6 Cu/Al	(12) #4-#14 Cu/#8 Al	Al 760A	CH16530_

Note

- ^① Incomplete catalog number—add code suffix **-1**, **-2**, **-3** for number of poles.
Example: For a 150A 1/0-#14 Cu to 1/0-#14 Cu three-pole PDB, order CH16201-3.

Product Overview

Terminal Blocks and Accessories Selection Guide



6

Description	XB Series IEC Terminal Blocks
	Page V9-T6-17
Available connections	Screw terminal, spring cage, insulation displacement (IDC)
Insulation material	Polyamide 6.6
Dielectric strength	600 kV/cm
Creep resistance	600 CTI
Flammability rating	UL 94 V0
Continuous operating temperature	-40° to 257°F (-40° to 125°C)
UL recognized	Yes
CE approved	Yes
ATEX approved	Yes
Jumpers/bridging	Flexible jumper system with dual channel configurations

XB Series IEC Terminal Blocks**Features**

- Maintenance-free connections
- Multi-conductor connections
- Flexible plug-in bridge system
- UL and cUL® recognized, CE approved
- LVD1 (Not all standards apply to all terminal blocks. Contact Eaton for details)
 - EN-60947-7-1; EN-60947-7-2; EN-60998-2-3; EN-60352-4/A1
- ATEX approval (EExe applications)

Product Selection**XB Series IEC Terminal Blocks****Screw Connection Single Level—Through-Feed Terminal Blocks**

Terminal Width	5.2 mm	6.2 mm	8.2 mm		
Maximum Wire Size	12 AWG/2.5 mm ²	10 AWG/4 mm ²	8 AWG/6 mm ²		
IEC 60 947-7-1 in V/A/AWG	800/32/26-12	800/41/26-10	800/57/24-8		
EN 50 019 [Ⓢ] in V/A/AWG	750/22/28/26-12	750/30/38/26-10	750/40/50/24-8		
UL-cUL Ratings in V/A/AWG	600/20/26-12	600/30/26-10	600/50/24-8		
Description	Color	Number of Positions	Catalog Number	Catalog Number	Catalog Number
Product Selection					
Screw connection single level—through-feed	Gray	—	XBUT25	XBUT4	XBUT6
	Blue	—	XBUT25BU	XBUT4BU	XBUT6BU
	Orange	—	—	XBUT4OR	—
	Yellow	—	—	XBUT4YE	—
	Red	—	—	XBUT4RD	—
	White	—	—	XBUT4WH	—
	Black	—	—	XBUT4BK	—
	Green	—	—	XBUT4GN	—
Accessories					
End cover	Gray	—	XBACUT10	XBACUT10	XBACUT10
Partition plate	Gray	—	XBATUT10	XBATUT10	XBATUT10
Plug-in bridge—for cross connections in the bridge shaft	Red	2	XBAFBS25	XBAFBS26	XBAFBS28
		3	XBAFBS35	XBAFBS36	—
		5	XBAFBS55	XBAFBS56	—
		10	XBAFBS105	XBAFBS106	—
		50	XBAFBS505	XBAFBS506	—

Note

[Ⓢ] EU type—examination certificate number: KEMA 05ATEX2158 U.

Screw Connection Single Level—Through-Feed Terminal Blocks, continued

Terminal Width			5.2 mm	6.2 mm	8.2 mm
Maximum Wire Size			12 AWG/2.5 mm ²	10 AWG/4 mm ²	8 AWG/6 mm ²
IEC 60 947-7-1 in V/A/AWG			800/32/26-12	800/41/26-10	800/57/24-8
EN 50 019 ^① in V/A/AWG			750/22/28/26-12	750/30/38/26-10	750/40/50/24-8
UL-cUL Ratings in V/A/AWG			600/20/26-12	600/30/26-10	600/50/24-8
Description	Color	Number of Positions	Catalog Number	Catalog Number	Catalog Number
Product Selection					
Screw connection single level—through-feed	Gray	—	XBUT10	XBUT16	XBUT35
	Blue	—	XBUT10BU	XBUT16BU	XBUT35BU
	Orange	—	XBUT10OR	—	—
	Yellow	—	XBUT10YE	—	—
	Red	—	XBUT10RD	—	—
	White	—	—	—	—
	Black	—	—	—	—
	Green	—	—	—	—
Accessories					
End cover	Gray	—	XBACUT10	XBACUT16	②
Partition plate	Gray	—	XBATUT10	—	—
Plug-in bridge—for cross connections in the bridge shaft	Red	2	XBAFBS210	XBAFBS212	XBAFBS216
		3	—	—	—
		5	—	—	—
		10	—	—	—
		50	—	—	—

Notes

① EU type—examination certificate number: KEMA 05ATEX2158 U.

② XBUT35 has an enclosed design. The use of an end cover is not required.

Screw Connection Single Level—Ground Blocks

Terminal Width Maximum Wire Size IEC 60 947-7-2 in V/A/AWG EN 50 019 ^① in V/A/AWG UL-cUL Ratings in V/A/AWG			10.2 mm 12 AWG/2.5 mm ² —/—/26-12 —/—/26-12 —/—/26-12	6.2 mm 10 AWG/4 mm ² —/—/26-10 —/—/26-10 —/—/26-10	8.2 mm 8 AWG/6 mm ² —/—/24-8 —/—/24-8 —/—/24-8
Description	Color	Number of Positions	Catalog Number	Catalog Number	Catalog Number
Product Selection					
Screw connection single level ground block	Green/ yellow	—	XBUT25PE	XBUT4PE	XBUT6PE
Accessories					
End cover	Gray	—	XBACUT10	XBACUT10	XBACUT10
Partition plate	Gray	—	XBATUT10	XBATUT10	XBATUT10
Plug-in bridge—for cross connections in the bridge shaft	Red	2	XBAFBS25	XBAFBS26	XBAFBS28
		3	XBAFBS35	XBAFBS36	—
		5	XBAFBS55	XBAFBS56	—
		10	XBAFBS105	XBAFBS106	—
		50	XBAFBS505	XBAFBS506	—

Screw Connection Single Level—Ground Blocks, continued

Terminal Width Maximum Wire Size IEC 60 947-7-2 in V/A/AWG EN 50 019 ^① in V/A/AWG UL-cUL Ratings in V/A/AWG			10.2 mm 12 AWG/2.5 mm ² —/—/26-12 —/—/26-12 —/—/26-12	6.2 mm 10 AWG/4 mm ² —/—/26-10 —/—/26-10 —/—/26-10	8.2 mm 8 AWG/6 mm ² —/—/24-8 —/—/24-8 —/—/24-8
Description	Color	Number of Positions	Catalog Number	Catalog Number	Catalog Number
Product Selection					
Screw connection single level ground block	Green/ yellow	—	XBUT10PE	XBUT16PE	XBUT35PE
Accessories					
End cover	Gray	—	XBACUT10	XBACUT16	^②
Partition plate	—	—	XBATUT10	—	—
Plug-in bridge—for cross connections in the bridge shaft	Red	2	XBAFBS210	XBAFBS212	XBAFBS212
		3	—	—	—
		5	—	—	—
		10	—	—	—
		50	—	—	—

Notes

^① EU type—examination certificate number: KEMA 05ATEX2158 U.

^② XBUT35PE has an enclosed design. The use of an end cover is not required.

Screw Connection Multi-Conductor Terminal Blocks

Description	Color	Number of Positions	5.2 mm	6.2 mm
			12 AWG/2.5 mm ² 500/28/26-12 150/20/26-12	10 AWG/4 mm ² 500/39/26-10 150/30/26-10
Product Selection				
Screw connection multi-conductor	Gray	—	XBUT25D12	XBUT4D12
		—	XBUT25D22	XBUT4D22
	Blue	—	XBUT25D12BU	XBUT4D12BU
		—	XBUT25D22BU	XBUT4D22BU
Accessories				
End cover	Gray	—	XBACUT4D12	XBACUT4D12
		—	XBACUT4D22	XBACUT4D22
End cover segment	Gray	—	XBASUT4	XBASUT4
Partition plate		—	XBATUTD12	XBATUTD12
			XBATUTD22	XBATUTD22
Plug-in bridge—for cross connections in the bridge shaft	Red	2	XBAFBS25	XBAFBS26
		3	XBAFBS35	XBAFBS36
		5	XBAFBS55	XBAFBS56
		10	XBAFBS105	XBAFBS106
		50	XBAFBS505	XBAFBS506

Screw Connection Multi-Conductor Ground Blocks

Description	Color	Number of Positions	5.2 mm	6.2 mm
			12 AWG/2.5 mm ² —/—/26-12 —/—/26-12	10 AWG/4 mm ² —/—/26-10 —/—/26-10
Product Selection				
Screw connection multi-conductor ground block	Green/ yellow	—	XBUT25D12PE	XBUT4D12PE
		—	XBUT25D22PE	XBUT4D22PE
Accessories				
End cover	Gray	—	XBACUT4D12	XBACUT4D12
		—	XBACUT4D22	XBACUT4D22
End cover segment	Gray	—	XBASUT4	XBASUT4
Partition plate		—	XBATUTD12	XBATUTD12
Plug-in bridge—for cross connections in the bridge shaft	Red	2	XBAFBS25	XBAFBS26
		3	XBAFBS35	XBAFBS36
		5	XBAFBS55	XBAFBS56
		10	XBAFBS105	XBAFBS106
		50	XBAFBS505	XBAFBS506

Screw Connection Double Level Terminal Blocks

Terminal Width Maximum Wire Size IEC 60 947-7-1 in V/A/AWG UL-cUL Ratings in V/A/AWG			6.2 mm 10 AWG/4 mm ² 800/36/26-10 300/30/26-10	6.2 mm 10 AWG/4 mm ² —/—/26-10 —/—/26-10
Description	Color	Number of Positions	Catalog Number	Catalog Number
Product Selection				
Screw connection double level	Gray	—	XBUTT4	—
	Blue	—	XBUTT4BU	—
	Red	—	XBUTT4RD	—
Screw connection double level—terminal block with potential distribution between the levels	Gray	—	XBUTT4PV	—
Screw connection double level—ground block	Green/ yellow	—	—	XBUTT4PE
Accessories				
End cover	Gray	—	XBACUTT4	XBACUTT4
Spacer plate	Gray	—	XBDPUTT4	XBDPUTT4
Partition plate	—	—	XBATUTT4	XBATUTT4
Plug-in bridge—for cross connections in the bridge shaft	Red	2	XBAFBS26	XBAFBS26
		3	XBAFBS36	XBAFBS36
		5	XBAFBS56	XBAFBS56
		10	XBAFBS106	XBAFBS106
		50	XBAFBS506	XBAFBS506

Screw Connection Triple Level Sensor/Actuator Terminal Blocks

Terminal Width Maximum Wire Size Connection Data in V/A/AWG IEC 60 947-7-1 in V/A/AWG UL-cUL Ratings in V/A/AWG			6.2 mm 14 AWG/2.5 mm ² 250/26/24-12 — 300/15/30-14	6.2 mm 14 AWG/2.5 mm ² — 250/30/24-12 300/15/30-14
Description	Color	Number of Positions	Catalog Number	Catalog Number
Product Selection				
Screw connection triple level	Gray blue	—	XB3UKA25	XB3UKF25
Screw connection triple level w/red LED, 15–30 Vdc, 2.5–7.5A	Gray	—	XB3UKA25L24	—
Screw connection with ground connection	Gray	—	XB3UKA24PE	XB3UKF24PE
Screw connection with ground connection and LED indicator	Gray	—	XB3UKA24PEL24	—
Accessories				
Insertion bridge	Blue	80	XBAEB80DIKB	XBAEB80DIKB
	Red	80	XBAEB80DIKR	XBAEB80DIKR
	Blue	10	XBAEB10DIKB	XBAEB10DIKB
	Red	10	XBAEB10DIKR	XBAEB10DIKR
Blank marker strip (strip of 10)	White	—	XBMBZB6 ①	XBMBZB6 ①

Note

① For information on Printed Marking Tag Options, see **Page V9-T6-33**.

Screw Connection Fuse Terminal Blocks

Terminal Width

Maximum Wire Size

IEC 60 947-7-3 in V/A/AWG

IEC 60 947-7-3 as Disconnected Terminal Block in V/A/AWG

UL-cUL Ratings in V/A/AWG

Description

Color

Number of Positions

6.2 mm

10 AWG/4 mm²

①/6.3/26-10

600/6.3/26-10

Catalog Number

8.2 mm

8 AWG/6 mm²

①/10/24-8

400/10/24-8

Catalog Number

12 mm

6 AWG/16 mm²

②/3/20-4

800/10/20-6

300/20/22-6

Catalog Number

Product Selection

Description	Color	Number of Positions	6.2 mm 10 AWG/4 mm ² ①/6.3/26-10 600/6.3/26-10 Catalog Number	8.2 mm 8 AWG/6 mm ² ①/10/24-8 400/10/24-8 Catalog Number	12 mm 6 AWG/16 mm ² ②/3/20-4 800/10/20-6 300/20/22-6 Catalog Number
Fuse terminal block for 5 x 20 mm fuse	Black	—	XBUT4FBE	—	XBUK10FBCE
Fuse terminal block for 6.3 x 32 mm (1/4 x 1-1/4 in) fuse	Black	—	—	XBUT6FBN	XBUK10FBCN
Fuse terminal block w/LED 12–30V, 1–2.5 mA	Black	—	XBUT4FBEL24	XBUT6FBNL24	—
Fuse terminal block w/LED 30–60V, 0.8–2.0 mA	Black	—	XBUT4FBEL60	XBUT6FBNL60	—
Fuse terminal block w/LED 110–250V, 0.5–2.5 mA	Black	—	XBUT4FBEL250	XBUT6FBNL250	—
Fuse terminal block w/LED 15–30V, 1–2.5 mA, 5 x 20 mm	Black	—	—	—	XBUK10FBCEL24
Fuse terminal block w/LED 15–30V, 1–2.5 mA, 6.3 x 32 mm	Black	—	—	—	XBUK10FBCNL24
Fuse terminal block w/LED 110–250V, 0.5–1.1A, 5 x 20 mm	Black	—	—	—	XBUK10FBCEL250
Fuse terminal block w/LED 110–250V, 0.5–1.1A, 6.3 x 32 mm	Black	—	—	—	XBUK10FBCNL250

Accessories

End cover	—	—	③	③	—
Plug-in bridge—for cross connections in the bridge shaft	Red	2	XBAFBS26	XBAFBS28	—
		3	XBAFBS36	XBAFBS38	—
		5	XBAFBS56	XBAFBS58	—
		10	XBAFBS106	XBAFBS108	—
		50	XBAFBS506	XBAFBS508	—

Notes

Max. power dissipation at 23°C (based on DIN EN 60 947-7-3: 2003-7. When selecting cartridge fuse inserts, please ensure that the maximum power dissipation specified above is not exceeded. Details can be obtained from the fuse suppliers. Cartridge fuse inserts 5 x 20 mm based on DIN EN 60 947-7-3: 2003-7.

Terminal Block	U (V)	Overload Protection		I _{max} (A)
		Individual	Interconnected	
XBUT4FBE	250	1.6W	1.6W	6.3

If the fuse is defective, the downstream circuit is not off load.

- ① As disconnect terminal block 400V, as fuse terminal block 250V.
 ② The current is determined by the fuse used, the voltage by the selected light indicator.
 ③ XBUT4FBE and XBUT6FBN have an enclosed design. The use of an end cover is not required.

Spring Cage Single Level—Through-Feed Terminal Blocks

Description	Color	Number of Positions	5.2 mm	6.2 mm	8.2 mm
			12 AWG/2.5 mm ² 800/31/28-12 550/25/21/24-12 600/20/26-12	10 AWG/4 mm ² 800/40/28-10 550/34/30/24-10 600/30/20-10	8 AWG/6 mm ² 800/52/24-8 550/45/36/20-8 600/50/20-8
Product Selection					
Spring cage single level—through-feed	Gray	—	XBPT25	XBPT4	XBPT6
	Blue	—	XBPT25BU	XBPT4BU	XBPT6BU
	White	—	XBPT25WH	—	—
	Red	—	XBPT25RD	—	—
	Black	—	XBPT25BK	—	—
Accessories					
End cover	Gray	—	XBACPT25	XBACPT4	XBACPT6
Partition plate	—	—	XBATPT4	XBATPT4	XBATPT6
Plug-in bridge—for cross connections in the terminal center	Red	2	XBAFBS25	XBAFBS26	XBAFBS28
		3	XBAFBS35	XBAFBS36	—
		5	XBAFBS55	XBAFBS56	—
		10	XBAFBS105	XBAFBS106	—
		50	XBAFBS505	XBAFBS506	—

Spring Cage Single Level—Through-Feed Terminal Blocks, continued

Description	Color	Number of Positions	10.2 mm	12 mm	16 mm
			6 AWG/10 mm ² 800/65/24-6 550/50/63/16-6 600/65/16-6	4 AWG/16 mm ² 800/90/24-4 550/65/82/16-4 600/50/16-4	2 AWG/35 mm ² 800/125/14-2 750/108/14-2 600/115/14-2
Product Selection					
Spring cage single level—through-feed	Gray	—	XBPT10	XBPT16	XBPT35
	Blue	—	XBPT10BU	XBPT16BU	XBPT35BU
	White	—	—	—	—
	Red	—	—	—	—
	Black	—	—	—	—
Accessories					
End cover	Gray	—	XBACPT10	XBACPT16	②
Partition plate	—	—	—	—	—
Plug-in bridge—for cross connections in the terminal center	Red	2	XBAFBS210	XBAFBS212	XBAFBS216
		3	—	—	—
		5	—	—	—
		10	—	—	—
		50	—	—	—

Notes

① EU type—examination certificate number: KEMA 05ATEX2154 U (XBPT25), KEMA 05ATEX2155 U (XBPT4), KEMA 05ATEX2155 U (XBPT6), KEMA 05ATEX2156 U (XBPT10).

② XBPT35 has an enclosed design. The use of an end cover is not required.

Screw Connection Single Level—Ground Blocks

Terminal Width			5.2 mm	6.2 mm	8.2 mm
Maximum Wire Size			12 AWG/2.5 mm ²	10 AWG/4 mm ²	8 AWG/6 mm ²
IEC 60 947-7-2 in V/A/AWG			—/—/28-12	—/—/28-10	—/—/24-8
EN 50 019 ^① in V/A/AWG			—/—/24-12	—/—/24-10	—/—/20-8
UL-cUL Ratings in V/A/AWG			—/—/26-12	—/—/20-10	—/—/20-8
Description	Color	Number of Positions	Catalog Number	Catalog Number	Catalog Number
Product Selection					
Spring cage single level ground block	Green/ yellow	—	XBPT25PE	XBPT4PE	XBPT6PE
Accessories					
End cover	Gray	—	XBACPT25	XBACPT4	XBACPT6
Plug-in bridge—for cross connections in the terminal center	—	2	—	—	—

Screw Connection Single Level—Ground Blocks, continued

Terminal Width			10.2 mm	12 mm	16 mm
Maximum Wire Size			6 AWG/10 mm ²	4 AWG/16 mm ²	2 AWG/35 mm ²
IEC 60 947-7-2 in V/A/AWG			—/65/24-6	—/90/24-4	—/125/14-2
EN 50 019 ^① in V/A/AWG			—/—/16-6	—/—/16-4	—/—/14-2
UL-cUL Ratings in V/A/AWG			—/—/16-6	—/—/16-4	—/—/14-2
Description	Color	Number of Positions	Catalog Number	Catalog Number	Catalog Number
Product Selection					
Spring cage single level ground block	Green/ yellow	—	XBPT10PE	XBPT16PE	XBPT35PE
Accessories					
End cover	Gray	—	XBACPT10	XBACPT16	^②
Plug-in Bridge — for cross connections in the terminal center	—	2	XBAFBS210	XBAFBS212	XBAFBS216

Notes

- ^① EU type—examination certificate number: KEMA 05ATEX2154 U (XBPT25PE), KEMA 05ATEX2155 U (XBPT4PE, XBPT6PE), KEMA 05ATEX2156 U (9XBPT10PE).
^② XBPT35PE has an enclosed design. The use of an end cover is not required.

Spring Cage Multi-Conductor Terminal Blocks

Description	Color	Number of Positions	5.2 mm	6.2 mm
			Catalog Number	Catalog Number
Terminal Width				
Maximum Wire Size				
IEC 60 947-7-1 in V/A/AWG				
EN 50 019 [Ⓢ] in V/A/AWG				
UL-cUL Ratings in V/A/AWG				
Product Selection				
Spring cage multi-conductor	Gray	—	XBPT25D12	XBPT4D12
		—	XBPT25D22	XBPT4D22
	Blue	—	XBPT25D12BU	XBPT4D12BU
		—	XBPT25D22BU	XBPT4D22BU
Spring cage multi-conductor with interrupted busbar	Gray	—	XBPT25D22U	XBPT4D22U
Accessories				
End cover	Gray	—	XBACPT25D12	XBACPT4D12
	—	—	XBACPT24D22	XBACPT4D22
End cover segment	Gray	—	XBASPT25	XBASPT4
Partition plate			XBATPTD12	XBATPTD12
			XBATPTD22	XBATPTD22
Plug-in bridge—for cross connections in the terminal center	Red	2	XBAFBS25	XBAFBS26
		3	XBAFBS35	XBAFBS36
		5	XBAFBS55	XBAFBS56
		10	XBAFBS105	XBAFBS106
		50	XBAFBS505	XBAFBS506

Spring Cage Multi-Conductor Ground Blocks

Description	Color	Number of Positions	5.2 mm	6.2 mm
			Catalog Number	Catalog Number
Terminal Width				
Maximum Wire Size				
IEC 60 947-7-2 in V/A/AWG				
EN 50 019 [Ⓢ] in V/A/AWG				
UL-cUL Ratings in V/A/AWG				
Product Selection				
Spring cage multi-conductor ground block	Green/ yellow	—	XBPT25D12PE	XBPT4D12PE
		—	XBPT25D22PE	XBPT4D22PE
Accessories				
End cover	Gray	—	XBACPT25D12	XBACPT4D12
		—	XBACPT25D22	XBACPT4D22
End cover segment	Gray	—	XBASPT25	XBASPT4

Note

[Ⓢ] EU type—examination certificate number: KEMA 05ATEX2154 U (XBPT25D12, XBPT25D22), KEMA 05ATEX2155 U (XBPT4D12, XBPT4D22).

Spring Cage Double Level Blocks

Description	Color	Number of Positions	5.2 mm	6.2 mm
			12 AWG/2.5 mm ²	10 AWG/4 mm ²
Terminal Width				
Maximum Wire Size				
IEC 60 947-7-1 in V/A/AWG				
EN 50 019 ^① in V/A/AWG				
UL-cUL Ratings in V/A/AWG				
			500/26/28-12	500/32/28-10
			420/23/19/24-12	420/32/27/24-10
			600/20/26-12	300/30/20-10
			Catalog Number	Catalog Number
Product Selection				
Spring cage double level block	Gray	—	XBPTT25	XBPTT4
	Blue	—	XBPTT25BU	XBPTT4BU
Spring cage double level ground block	Green/ yellow	—	XBPTT25PE	XBPTT4PE
Spring cage double level—terminal block with potential distribution between the levels	Gray	—	XBPTT25PV	XBPTT4PV
Accessories				
End cover	Gray	—	XBACPTT25	XBACPTT4
Partition plate	—	—	XBATPTT4	XBATPTT4
Plug-in bridge—for cross connections in the terminal center	Red	2	XBAFBS25	XBAFBS26
		3	XBAFBS35	XBAFBS36
		5	XBAFBS55	XBAFBS56
		10	XBAFBS105	XBAFBS106
		50	XBAFBS505	XBAFBS506

Spring Cage Triple Level Blocks

Description	Color	Number of Positions	5.2 mm
			12 AWG/2.5 mm ²
Terminal Width			
Maximum Wire Size			
IEC 60 947-7-1 in V/A/AWG			
UL-cUL Ratings in V/A/AWG			
			500/28/28-12
			600/20/26-12
			Catalog Number
Product Selection			
Spring cage triple level block	Gray	—	XBPTK25
Spring cage triple level—terminal block with potential distribution between the levels	Gray	—	XBPTK25PV
Accessories			
End cover	Gray	—	XBACPT25K
Plug-in bridge—for cross connections in the terminal center	Red	2	XBAFBS25
		3	XBAFBS35
		5	XBAFBS55
		10	XBAFBS105
		50	XBAFBS505

Note

^① EU type—examination certificate number: KEMA 05ATEX2154 U (XBPTT25, XBPTT25PE), KEMA 05ATEX2155 U (XBPTT4, XBPTT4PE).

Spring Cage Fuse Terminal Block

Terminal Width

Maximum Wire Size

IEC 60 947-7-3 with Fuse in V/A/AWG

IEC 60 947-7-3 as Disconnect Terminal Block in V/A/AWG

UL-cUL Ratings in V/A/AWG

Description	Color	Number of Positions	6.2 mm	8.2 mm
			10 AWG/4 mm ² ①/③/28-10 250/6.3/28-10 300/6.3/24-10	10 AWG/4 mm ² 400/10/28-10 400/10/28-10 300/10/24-10
Product Selection				
Fuse terminal block for 5 x 20 mm fuse	Black	—	XBPT4FBE	—
Fuse terminal block w/LED 15–30V, 3.5–8.1A	Black	—	XBPT4FBEL24	—
Fuse terminal block w/LED 30–60V, 0.8–2.0A	Black	—	XBPT4FBEL60	—
Fuse terminal block w/LED 110–250V, 0.5–1.0A	Black	—	XBPT4FBEL250	—
Fuse terminal block for 6.3 x 32 mm (1/4 x 1-1/4 in) fuse	Black	—	—	XBPT4FBN
Fuse terminal block w/LED 12–30V, 1.0–2.5 mA	Black	—	—	XBPT4FBNL24
Fuse terminal block w/LED 110–250V, 0.5–2.5 mA	Black	—	—	XBPT4FBNL250
Accessories				
Partition plate	—	—	XBATPT4	XBATQTD12
Plug-in bridge—for cross connections in the terminal center	Red	2	XBAFBS26	XBAFBS28
		3	XBAFBS36	—
		5	XBAFBS56	—
		10	XBAFBS106	—

Notes

The cartridge fuse holders should be selected according to the maximum power dissipation (self-heating) of the cartridge fuse inserts. The thermal conditions in closed fuse holes should be checked according to the application and installation. Higher ambient temperatures are an additional strain on fuse inserts. In applications of this kind, the shift of the rated current should be taken into consideration accordingly. Max. power dissipation at 23°C (in acc. with IEC 60 947-7-3). When selecting cartridge fuse inserts, please ensure that the maximum power dissipation specified at right is not exceeded. Details can be obtained from the fuse suppliers. Cartridge fuse inserts 5 x 20 and 6.3 x 32 mm in acc. with IEC 60 947-7-3.

Terminal Block	U (V)	Individual	Interconnected
Overload Protection			
XBPT4FBN	400	1.6W	1.6W
XBPT4FBE	250	1.6W	1.6W
Short Circuit Protection Only			
XBPT4FBN	400	4W	2.5W
XBPT4FBE	250	4W	2.5W

① The current is determined by the fuse used, the voltage by the selected light indicator. See table above.

Insulation Displacement Connection—Single Level Terminal Blocks

Terminal Width	5.2 mm	5.2 mm	6.2 mm	6.2 mm		
Maximum Wire Size	16 AWG/1.5 mm ²	16 AWG/1.5 mm ²	14 AWG/2.5 mm ²	14 AWG/2.5 mm ²		
Connection Data in V/A/AWG	800/17.5/24-16	—/—/24-16	800/24/20-14	—/—/20-14		
EN 50 019 [Ⓢ] in V/A/AWG	550/16/24-16	—/—/24-16	—	—		
UL-cUL Ratings in V/A/AWG	600/10/24-16	—/—/24-16	600/15/20-14	—/—/20-14		
Description	Color	Number of Positions	Catalog Number	Catalog Number	Catalog Number	Catalog Number
Product Selection						
IDC terminal block—single level	Gray	—	XBQT15	—	XBQT25	—
	Blue	—	XBQT15BU	—	XBQT25BU	—
IDC ground block—single level	Green/ yellow	—	—	XBQT15PE	—	XBQT25PE
Accessories						
End cover	Gray	—	XBACQT15	XBACQT15	XBACQT25	XBACQT25
Partition plate	—	—	XBATQT25	XBATQT25	XBATQT25	XBATQT25
Plug-in bridge	Red	2	XBAFBS25	XBAFBS25	XBAFBS26	XBAFBS26
		3	XBAFBS35	XBAFBS35	XBAFBS36	XBAFBS36
		5	XBAFBS55	XBAFBS55	XBAFBS56	XBAFBS56
		10	XBAFBS105	XBAFBS105	XBAFBS106	XBAFBS106
		50	XBAFBS505	XBAFBS505	XBAFBS506	XBAFBS506

Insulation Displacement Connection—Multi-Conductor

Terminal Width	5.2 mm	5.2 mm	6.2 mm	6.2 mm		
Maximum Wire Size	16 AWG/1.5 mm ²	16 AWG/1.5 mm ²	14 AWG/2.5 mm ²	14 AWG/2.5 mm ²		
Connection Data in V/A/AWG	800/17.5/24-16	—/—/24-16	800/24/20-14	—/—/20-14		
EN 50 019 [Ⓢ] in V/A/AWG	550/16/24-16	—/—/24-16	—	—		
UL-cUL Ratings in V/A/AWG	600/10/24-16	—/—/24-16	600/15/20-14	—/—/20-14		
Description	Color	Number of Positions	Catalog Number	Catalog Number	Catalog Number	Catalog Number
Product Selection						
IDC terminal block—multi-conductor	Gray	—	XBQT15D12	—	XBQT25D12	—
		—	XBQT15D22	—	XBQT25D12BU	—
	Blue	—	XBQT15D12BU	—	—	—
		—	XBQT15D22BU	—	—	—
IDC ground block—multi-conductor	Green/ yellow	—	—	XBQT15D12PE	—	XBQT25D12PE
		—	—	XBQT15D22PE	—	—
Accessories						
End cover	Gray	—	XBACQT15D12	XBACQT15D12	XBACQT25D12	XBACQT25D12
		—	XBACQT15D22	XBACQT15D22	—	—
End cover segment	Gray	—	XBASQT15	XBASQT15	XBASQT25	XBASQT25
Partition plate		—	XBATQTD12	XBATQTD12	XBATQTD12	XBATQTD12
		—	XBATQTD22	XBATQTD22	—	—
Plug-in bridge	Red	2	XBAFBS25	XBAFBS25	XBAFBS26	XBAFBS26
		3	XBAFBS35	XBAFBS35	XBAFBS36	XBAFBS36
		5	XBAFBS55	XBAFBS55	XBAFBS56	XBAFBS56
		10	XBAFBS105	XBAFBS105	XBAFBS106	XBAFBS106
		50	XBAFBS505	XBAFBS505	XBAFBS506	XBAFBS506

Note

[Ⓢ] EU type—examination certificate number: KEMA 05ATEX2157 U (XBQT15, XBQT15PE), KEMA 05ATEX2160 U (XBQT25, XBQT25PE).

Insulation Displacement Connection—Double Level

Terminal Width	5.2 mm	5.2 mm		
Maximum Wire Size	16 AWG/1.5 mm ²	16 AWG/1.5 mm ²		
Connection Data in V/A/AWG	800/17.5/24-16	—/—/24-16		
EN 50 019 ^① in V/A/AWG	420/15/24-16	—/—/24-16		
UL-cUL Ratings in V/A/AWG	600/10/24-16	—/—/24-16		
Description	Color	Number of Positions	Catalog Number	Catalog Number
Product Selection				
IDC terminal block—double level	Gray	—	XBQTT15	—
	Blue	—	XBQTT15BU	—
IDC ground block—double level	Green/ yellow	—	—	XBQTT15PE
Accessories				
End cover	Gray	—	XBACQTT15	XBACQTT15
Partition plate	—	—	XBATQTT15	XBATQTT15
Plug-in bridge	Red	2	XBAFBS25	XBAFBS25
		3	XBAFBS35	XBAFBS35
		5	XBAFBS55	XBAFBS55
		10	XBAFBS105	XBAFBS105
		20	XBAFBS505	XBAFBS505

Insulation Displacement Connection Fuse Terminal Blocks

Terminal Width	6.2 mm		
Maximum Wire Size	14 AWG/2.5 mm ²		
Connection Data in V/A/AWG	②/6.3/20-14		
UL-cUL Ratings in V/A/AWG	300/15/20-14		
Description	Color	Number of Positions	Catalog Number
Product Selection			
IDC fuse terminal block	Black	—	XBQT25FBE
		With LED 12–30V, 1–2.5 mA	XBQT25FBEL24
		With LED 30–60V, 0.8–2.0 mA	XBQT25FBEL60
		With LED 110–250, 0.5–2.5 mA	XBQT25FBEL250
Accessories			
End cover	Gray	—	XBACQT25D12
Partition plate	—	—	XBATQTD12
Plug-in bridge	Red	2	XBAFBS26
		3	XBAFBS36
		5	XBAFBS56
		10	XBAFBS106

Notes

① EU type—examination certificate number: KEMA 05ATEX2157 U.

② As disconnect terminal block, 400V; as fuse terminal block, 250V.

Insulation Displacement Connection Disconnect and Component Terminal Blocks

Terminal Width	5.2 mm	5.2 mm		
Maximum Wire Size	16 AWG/1.5 mm ²	16 AWG/1.5 mm ²		
Connection Data in V/A/AWG	400/16/24-16	400/16/24-16		
UL-cUL Ratings in V/A/AWG	600/10/24-16	600/10/24-16		
Description	Color	Number of Positions	Catalog Number	Catalog Number
Product Selection				
IDC disconnect and component terminal block	Gray	—	XBQT15MT	XBQT15TG
Accessories				
End cover	Gray	—	XBACQT15D12	XBACQT15D12
End cover segment	Gray	—	XBASQT15	XBASQT15
Partition plate	—	—	XBATQTD12	XBATQTD12
Plug-in bridge	Red	2	XBAFBS25	XBAFBS25
		3	XBAFBS35	XBAFBS35
		5	XBAFBS55	XBAFBS55
		10	XBAFBS105	XBAFBS105
Component plug	Gray	—	—	XBPCO
Fuse plug	Black	—	—	XBPFU
Fuse plug with light indicator for 12–30V	Black	—	—	XBPFUL24
Fuse plug with light indicator for 110–250V	Black	—	—	XBPFUL250

Miniature Circuit Breakers

Connection Data in Vac/Vdc	250/65		
Description	Color	Number of Positions	Catalog Number
Product Selection			
Thermal miniature circuit breaker			
Nominal current 0.1A	Black	—	XBATCPT
Nominal current 0.25A	Black	—	XBATCPQ
Nominal current 0.5A	Black	—	XBATCPH
Nominal current 1.0A	Black	—	XBATCP1
Nominal current 2.0A	Black	—	XBATCP2
Nominal current 3.0A	Black	—	XBATCP3
Nominal current 4.0A	Black	—	XBATCP4
Nominal current 6.0A	Black	—	XBATCP6
Nominal current 8.0A	Black	—	XBATCP8
Nominal current 10.0A	Black	—	XBATCP10

Flat-Type Fuse Terminal Blocks

			8.2 mm	8.2 mm
Terminal Width			8 AWG/6 mm ²	8 AWG/6 mm ²
Maximum Wire Size			250/—/24-8	250/—/24-8
Connection Data in V/A/AWG			300/30/26-8	300/30/26-8
UL-cUL Ratings in V/A/AWG				
Description	Color	Number of Positions	Catalog Number	Catalog Number
Product Selection				
Flat-type fuse terminal block	Black	—	XBUK6FSI	—
Flat-type fuse terminal block with ...				
LED Red 12 Vdc, 2.0 mA	Black	—	—	XBUK6FSIL12
LED Red 24 Vdc, 2.0 mA	Black	—	—	XBUK6FSIL24

Spring Cage Fuse Terminal Blocks

			8.2 mm	8.2 mm
Terminal Width			10 AWG/4 mm ²	10 AWG/4 mm ²
Maximum Wire Size			400/30/28-10	400/30/28-10
Connection Data in V/A/AWG			300/30/24-10	300/30/24-10
UL-cUL Ratings in V/A/AWG				
Description	Color	Number of Positions	Catalog Number	Catalog Number
Product Selection				
Spring cage fuse terminal block	Black	—	XBPT4FSI	—
Spring cage fuse terminal block with ...				
LED red 12 Vdc, 2.0 mA	Black	—	—	XBPT4FSIL12
LED red 24 Vdc, 2.0 mA	Black	—	—	XBPT4FSIL24

Accessories

End-Stop



End-Stops

Description	Size	Std. Pack	Catalog Number
Snap-on end stops	35 mm	50	XBAES35N
Universal end stops	35 mm	50	XBAES35T
	35 mm	50	XBAES35C

6

DIN Rails



DIN Rails—35 x 7.5 mm x 2m

Size	Std. Pack	Catalog Number
25	Slotted	XBANS3575P

Marker Strips

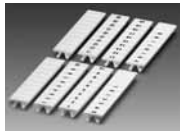

Marker Strips (Strip of 10)

Terminal Width (mm)	Std. Pack	Catalog Number
5.2	10	XBMZB5
6.2	10	XBMZB6
8.2	10	XBMZB8
10.2	10	XBMZB10
12	10	XBMZB12
16	10	XBMZB15 ^①
Flat		
5.2	10	XBMZBF5
6.2	10	XBMZBF6
8.2	10	XBMZBF8
10.2	10	XBMZBF10
12	10	XBMZBF12
16	10	XBMZBF15

Marker Sheets

Terminal Width (mm)	Color	Std. Pack	Catalog Number
---------------------	-------	-----------	----------------

Blank Marker Sheets



Marker Sheets (10 rows of 12)			
5.2	White	50	XBMPZB5
5.2	Blue	50	XBMPZB5BU
5.2	Red	50	XBMPZB5RD
5.2	Yellow	50	XBMPZB5YE
5.2	Green	50	XBMPZB5GN

Marker Sheets (10 rows of 10)			
6.2	White	50	XBMPZB6
6.2	Blue	50	XBMPZB6BU
6.2	Red	50	XBMPZB6RD
6.2	Yellow	50	XBMPZB6YE
6.2	Green	50	XBMPZB6GN

Flat Marker Sheets



Flat Marker Sheets (10 rows of 10)			
5.2	White	10	XBMPZBF5
5.2	Orange	10	XBMPZBF5OG
6.2	White	10	XBMPZBF6
6.2	Orange	10	XBMPZBF6OG
8.2	White	10	XBMPZBF8

Test Plugs



Test Plugs

Color	Std. Pack	Catalog Number
2.3 mm		
—	10	XBATSPSMT
Blue	10	XBATSPSIHBU
White	10	XBATSPSIHWH
Red	10	XBATSPSIHRD
Black	10	XBATSPSIHBK
4 mm		
—	10	XBATSPSMT
Blue	10	XBATSPSIHBU
White	10	XBATSPSIHWH
Red	10	XBATSPSIHRD
Black	10	XBATSPSIHBK

Note

^① All markers are strips of 10, except XBMZB15 which is a strip of 5.

Printed Marking Tags**Terminal Block
Marking Tag****Horizontal Printed
Marking Tag****Marking Tags for 5.2 mm Wide Terminal Blocks**

Description		Catalog Number
ZB5 tags vertically numbered	1–10 ①	XBMZB5V/1
	11–20	XBMZB5V/11
	21–30	XBMZB5V/21
	31–40	XBMZB5V/31
	41–50	XBMZB5V/41
	51–60	XBMZB5V/51
	61–70	XBMZB5V/61
	71–80	XBMZB5V/71
	81–90	XBMZB5V/81
	91–100	XBMZB5V/91
ZBF5 tags vertically numbered	1–10 ①	XBMZBF5V/1
	11–20	XBMZBF5V/11
	21–30	XBMZBF5V/21
	31–40	XBMZBF5V/31
	41–50	XBMZBF5V/41
	51–60	XBMZBF5V/51
	61–70	XBMZBF5V/61
	71–80	XBMZBF5V/71
	81–90	XBMZBF5V/81
	91–100	XBMZBF5V/91

Marking Tags for 6.2 mm Wide Terminal Blocks

Description		Catalog Number
ZB6 tags vertically numbered	1–10 ①	XBMZB6V/1
	11–20	XBMZB6V/11
	21–30	XBMZB6V/21
	31–40	XBMZB6V/31
	41–50	XBMZB6V/41
	51–60	XBMZB6V/51
	61–70	XBMZB6V/61
	71–80	XBMZB6V/71
	81–90	XBMZB6V/81
	91–100	XBMZB6V/91
ZBF6 tags vertically numbered	1–10 ①	XBMZBF6V/1
	11–20	XBMZBF6V/11
	21–30	XBMZBF6V/21
	31–40	XBMZBF6V/31
	41–50	XBMZBF6V/41
	51–60	XBMZBF6V/51
	61–70	XBMZBF6V/61
	71–80	XBMZBF6V/71
	81–90	XBMZBF6V/81
	91–100	XBMZBF6V/91

Notes

See **Page V9-T6-34** for marking tags for 8.2–16 mm wide terminal blocks.

① For text printed horizontally, change “V” in catalog number to “H.”

Terminal Block Marking Tag



Horizontal Printed Marking Tag



Marking Tags for 8.2 mm Wide Terminal Blocks

Description		Catalog Number
ZB8 tags vertically numbered	1–10 ①	XBMZB8V/1
	11–20	XBMZB8V/11
	21–30	XBMZB8V/21
	31–40	XBMZB8V/31
	41–50	XBMZB8V/41
	51–60	XBMZB8V/51
	61–70	XBMZB8V/61
	71–80	XBMZB8V/71
	81–90	XBMZB8V/81
	91–100	XBMZB8V/91
ZBF8 tags vertically numbered	1–10 ①	XBMZBF8V/1
	11–20	XBMZBF8V/11
	21–30	XBMZBF8V/21
	31–40	XBMZBF8V/31
	41–50	XBMZBF8V/41
	51–60	XBMZBF8V/51
	61–70	XBMZBF8V/61
	71–80	XBMZBF8V/71
	81–90	XBMZBF8V/81
	91–100	XBMZBF8V/91

Marking Tags for 10.2 mm Wide Terminal Blocks

Description		Catalog Number
ZB10 tags vertically numbered	1–10 ①	XBMZB10V/1
	11–20	XBMZB10V/11
	21–30	XBMZB10V/21
ZBF10 tags vertically numbered	1–10 ①	XBMZBF10V/1
	11–20	XBMZBF10V/11
	21–30	XBMZBF10V/21

Marking Tags for 12 mm Wide Terminal Blocks

Description		Catalog Number
ZB12 tags vertically numbered	1–10 ①	XBMZB12V/1
	11–20	XBMZB12V/11
	21–30	XBMZB12V/21
ZBF12 tags vertically numbered	11–10 ①	XBMZBF12V/1
	11–20	XBMZBF12V/11
	21–30	XBMZBF12V/21

Marking Tags for 16 mm Wide Terminal Blocks

Description		Catalog Number
ZB15 tags vertically numbered	11–10 ①	XBMZB15V/1
	11–20	XBMZB15V/11
	21–30	XBMZB15V/21
ZBF15 tags vertically numbered	1–10 ①	XBMZBF15V/1
	11–20	XBMZBF15V/11
	21–30	XBMZBF15V/21

Note

① For text printed horizontally, change “V” in catalog number to “H.”

Eaton Terms & Conditions



Terms & Conditions



Contents

<i>Description</i>	<i>Page</i>
Terms and Conditions of Sale	V9-A1-1
Terms of Payment	V9-A1-2
Freight	V9-A1-3
Warranty	V9-A1-3

Selling Policy (Supersedes Selling Policy 25-000, dated November 1, 2008)

Terms and Conditions of Sale

The Terms and Conditions of Sale set forth herein, and any supplements which may be attached hereto, constitute the full and final expression of the contract for the sale of products or services (hereinafter referred to as Product(s) or Services by Eaton Corporation (hereinafter referred to as Seller) to the Buyer, and supersedes all prior quotations, purchase orders, correspondence or communications whether written or oral between the Seller and the Buyer. Notwithstanding any contrary language in the Buyer's purchase order, correspondence or other form of acknowledgment, Buyer shall be bound by these Terms and Conditions of Sale when it sends a purchase order or otherwise indicates acceptance of this contract, or when it accepts delivery from Seller of the Products or Services.

THE CONTRACT FOR SALE OF THE PRODUCTS OR SERVICES IS EXPRESSLY LIMITED TO THE TERMS AND CONDITIONS OF SALE STATED HEREIN. ANY ADDITIONAL OR DIFFERENT TERMS PROPOSED BY BUYER ARE REJECTED UNLESS EXPRESSLY AGREED TO IN WRITING BY SELLER. No contract shall exist except as herein provided.

Complete Agreement

No amendment or modification hereto nor any statement, representation or warranty not contained herein shall be binding on the Seller unless made in writing by an authorized representative of the Seller. Prior dealings, usage of the trade or a course of performance shall not be relevant to determine the meaning of this contract even though the accepting or acquiescing party had knowledge of the nature of the performance and opportunity for objection.

Quotations

Written quotations are valid for 30 days from its date unless otherwise stated in the quotation or terminated sooner by notice.

Verbal quotations, unless accepted, expire the same day they are made.

A complete signed order must be received by Seller within 20 calendar days of notification of award, otherwise the price and shipment will be subject to re-negotiation.

Termination and Cancellation

Products

Any order may be terminated by the Buyer only by written notice and upon payment of reasonable termination charges, including all progress billings and all incurred direct manufacturing costs.

Services

Any order may be terminated by the Buyer only by written notice and upon payment of reasonable termination charges including all costs plus profit.

Seller shall have the right to cancel any order at any time by written notice if Buyer breaches any of the terms hereof, becomes the subject of any proceeding under state or federal law for the relief of debtors, or otherwise becomes insolvent or bankrupt, generally does not pay its debts as they become due or makes an assignment for the benefit of creditors.

Appendix 1—General Terms and Conditions of Sale

Effective Date: November 1, 2017

Prices

All prices are subject to change without notice. In the event of a price change, the effective date of the change will be the date of the new price or discount sheet, letter or telegram. All quotations made or orders accepted after the effective date will be on the new basis. For existing orders, the price of the unshipped portion of an order will be the price in effect at time of shipment.

Price Policy—Products and Services

When prices are quoted as firm for quoted shipment, they are firm provided the following conditions are met:

1. The order is released with complete engineering details.
2. Shipment of Products are made, and Services purchased are provided within the quoted lead time.
3. When drawings for approval are required for any Products, the drawings applicable to those Products must be returned within 30* calendar days from the date of the original mailing of the drawings by Seller. The return drawings must be released for manufacture and shipment and must be marked "APPROVED" or "APPROVED AS NOTED." Drawing re-submittals which are required for any other reason than to correct Seller errors will not extend the 30-day period.

* 60 days for orders through contractors to allow time for their review and approval before and after transmitting them to their customers.

If the Buyer initiates or in any way causes delays in shipment, provision of Services or return of approval drawings beyond the periods stated above, the price of the Products or Services will be increased 1% per month or fraction thereof up to a maximum of 18 months from the date of the Buyer's order. For delays resulting in shipment or provision of Services beyond 18 months from the date of the Buyer's order, the price must be renegotiated.

Price Policy—BLS

Refer to Price Policy 25-050.

Minimum Billing

Orders less than \$1,000 will be assessed a shipping and handling charge of 5% of the price of the order, with a minimum charge of \$25.00 unless noted differently on Product discount sheets.

Taxes

The price does not include any taxes. Buyer shall be responsible for the payment of all taxes applicable to, or arising from the transaction, the Products, its sale, value, or use, or any Services performed in connection therewith regardless of the person or entity actually taxed.

Terms of Payment

Products

Acceptance of all orders is subject to the Buyer meeting Seller's credit requirements. Terms of payment are subject to change for failure to meet such requirements. Seller reserves the right at any time to demand full or partial payment before proceeding with a contract of sale as a result of changes in the financial condition of the Buyer. Terms of Payment are either Net 30 days from the date of invoice of each shipment or carry a cash discount based on Product type. Specific payment terms for Products are outlined in the applicable Product discount schedules.

Services

Terms of payment are net within 30 days from date of invoice for orders amounting to less than \$50,000.00.

Terms of payment for orders exceeding \$50,000.00 shall be made according to the following:

1. Twenty percent (20%) of order value with the purchase order payable 30 days from date of invoice.
2. Eighty percent (80%) of order value in equal monthly payments over the performance period payable 30 days from date of invoice.

Except for work performed (i) under a firm fixed price basis or (ii) pursuant to terms of a previously priced existing contract between Seller and Buyer, invoices for work performed by Seller shall have added and noted on each invoice a charge of 3% (over and above the price of the work) which is related to Seller compliance with present and proposed environmental, health, and safety regulations associated with prescribed requirements covering hazardous materials management and employee training, communications, personal protective equipment, documentation and record keeping associated therewith.

Adequate Assurances

If, in the judgment of Seller, the financial condition of the Buyer, at any time during the period of the contract, does not justify the terms of payment specified, Seller may require full or partial payment in advance.

Delayed Payment

If payments are not made in accordance with these terms, a service charge will, without prejudice to the right of Seller to immediate payment, be added in an amount equal to the lower of 1.5% per month or fraction thereof or the highest legal rate on the unpaid balance.

Freight

Freight policy will be listed on the Product discount sheets, or at option of Seller one of the following freight terms will be quoted.

F.O.B.—P/S—Frt./Ppd. and Invoiced

Products are sold F.O.B. point of shipment freight prepaid and invoiced to the Buyer.

F.O.B.—P/S—Frt./Ppd. and Allowed

Products sold are delivered F.O.B. point of shipment, freight prepaid and included in the price.

F.O.B. Destination—Frt./Ppd. and Allowed

At Buyer's option, Seller will deliver the Products F.O.B. destination freight prepaid and 2% will be added to the net price.

The term "freight prepaid" means that freight charges will be prepaid to the accessible common carrier delivery point nearest the destination for shipments within the United States and Puerto Rico unless noted differently on the Product discount sheets. For any other destination, contact Seller's representative.

Shipment and Routing

Seller shall select the point of origin of shipment, the method of transportation, the type of carrier equipment and the routing of the shipment.

If the Buyer specifies a special method of transportation, type of carrier equipment, routing, or delivery requirement, Buyer shall pay all special freight and handling charges.

When freight is included in the price, no allowance will be made in lieu of transportation if the Buyer accepts shipment at factory, warehouse, or freight station or otherwise supplies its own transportation.

Risk of Loss

Risk of loss or damage to the Products shall pass to Buyer at the F.O.B. point.

Concealed Damage

Except in the event of F.O.B. destination shipments, Seller will not participate in any settlement of claims for concealed damage.

When shipment has been made on an F.O.B. destination basis, the Buyer must unpack immediately and, if damage is discovered, must:

1. Not move the Products from the point of examination.
2. Retain shipping container and packing material.
3. Notify the carrier in writing of any apparent damage.
4. Notify Seller representative within 72 hours of delivery.
5. Send Seller a copy of the carrier's inspection report.

Witness Tests/Customer Inspection

Standard factory tests may be witnessed by the Buyer at Seller's factory for an additional charge calculated at the rate of \$2,500 per day (not to exceed eight (8) hours) per Product type. Buyer may final inspect Products at the Seller's factory for \$500 per day per Product type.

Witness tests will add one (1) week to the scheduled shipping date. Seller will notify Buyer fourteen (14) calendar days prior to scheduled witness testing or inspection. In the event Buyer is unable to attend, the Parties shall mutually agree on a rescheduled date. However, Seller reserves the right to deem the witness tests waived with the right to ship and invoice Products.

Held Orders

For any order held, delayed or rescheduled at the request of the Buyer, Seller may, at its sole option (1) require payment to be based on any reasonable basis, including but not limited to the contract price, and any additional expenses, or cost resulting from such a delay; (2) store Products at the sole cost and risk of loss of the Buyer; and/ or (3) charge to the Buyer those prices under the applicable price policy. Payment for such price, expenses and costs, in any such event, shall be due by Buyer within thirty (30) days from date of Seller's invoice. Any order so held delayed or rescheduled beyond six (6) months will be treated as a Buyer termination.

Drawing Approval

Seller will design the Products in line with, in Seller's judgment, good commercial practice. If at drawing approval Buyer makes changes outside of the design as covered in their specifications, Seller will then be paid reasonable charges and allowed a commensurate delay in shipping date based on the changes made.

Drawing Re-Submittal

When Seller agrees to do so in its quotation, Seller shall provide Buyer with the first set of factory customer approval drawing(s) at Seller's expense. The customer approval drawing(s) will be delivered at the quoted delivery date. If Buyer requests drawing changes or additions after the initial factory customer approval drawing(s) have been submitted by Seller, the Seller, at its option, may assess Buyer drawing charges. Factory customer approval drawing changes required due to misinterpretation by Seller will be at Seller's expense. Approval drawings generated by Bid Manager are excluded from this provision.

Warranty

Warranty for Products

Seller warrants that the Products manufactured by it will conform to Seller's applicable specifications and be free from failure due to defects in workmanship and material for one (1) year from the date of installation of the Product or eighteen (18) months from the date of shipment of the Product, whichever occurs first.

In the event any Product fails to comply with the foregoing warranty, Seller will, at its option, either (a) repair or replace the defective Product, or defective part or component thereof, F.O.B. Seller's facility freight prepaid, or (b) credit Buyer for the purchase price of the Product. All warranty claims shall be made in writing.

Seller requires all non-conforming Products be returned at Seller's expense for evaluation unless specifically stated otherwise in writing by Seller.

This warranty does not cover failure or damage due to storage, installation, operation or maintenance not in conformance with Seller's recommendations and industry standard practice or due to accident, misuse, abuse or negligence. This warranty does not cover reimbursement for labor, gaining access, removal, installation, temporary power or any other expenses, which may be incurred in connection with repair or replacement.

This warranty does not apply to equipment not manufactured by Seller. Seller limits itself to extending the same warranty it receives from the supplier.

Appendix 1—General Terms and Conditions of Sale

Effective Date: November 1, 2017

Extended Warranty for Products

If requested by the Buyer and specifically accepted in writing by Seller, the foregoing standard warranty for Products will be extended from the date of shipment for the period and price indicated below:

- 24 months—2% of Contract Price
- 30 months—3% of Contract Price
- 36 months—4% of Contract Price

Special Warranty (In and Out) for Products

If requested by the Buyer and specifically accepted in writing by Seller, Seller will, during the warranty period for Products, at an additional cost of 2% of the contract price, be responsible for the direct cost of:

1. Removing the Product from the installed location.
2. Transportation to the repair facility and return to the site.
3. Reinstallation on site.

The total liability of Seller for this Special Warranty for Products is limited to 50% of the contract price of the particular Product being repaired and excludes expenses for removing adjacent apparatus, walls, piping, structures, temporary service, etc.

Warranty for Services

Seller warrants that the Services performed by it hereunder will be performed in accordance with generally accepted professional standards.

The Services, which do not so conform, shall be corrected by Seller upon notification in writing by the Buyer within one (1) year after completion of the Services.

Unless otherwise agreed to in writing by Seller, Seller assumes no responsibility with respect to the suitability of the Buyer's, or its customer's, equipment or with respect to any latent defects in equipment not supplied by Seller. This warranty does not cover damage to Buyer's, or its customer's, equipment, components or parts resulting in whole or in part from improper maintenance or operation or from their deteriorated condition. Buyer will, at its cost, provide Seller with unobstructed access to the defective Services, as well as adequate free working space in the immediate vicinity of the defective Services and such facilities and systems, including, without limitation, docks, cranes and utility disconnects and connects, as may be necessary in order that Seller may perform its warranty obligations. The conducting of any tests shall be mutually agreed upon and Seller shall be notified of, and may be present at, all tests that may be made.

Warranty for Power Systems Studies

Seller warrants that any power systems studies performed by it will conform to generally accepted professional standards. Any portion of the study, which does not so conform, shall be corrected by Seller upon notification in writing by the Buyer within six (6) months after completion of the study. All warranty work shall be performed in a single shift straight time basis Monday through Friday. In the event that the study requires correction of warranty items on an overtime schedule, the premium portion of such overtime shall be for the Buyer's account.

Limitation on Warranties for Products, Services and Power Systems Studies

THE FOREGOING WARRANTIES ARE EXCLUSIVE EXCEPT FOR WARRANTY OF TITLE. SELLER DISCLAIMS ALL OTHER WARRANTIES INCLUDING ANY IMPLIED WARRANTIES OF MERCHANTABILITY AND FITNESS FOR A PARTICULAR PURPOSE.

CORRECTION OF NON-CONFORMITIES IN THE MANNER AND FOR THE PERIOD OF TIME PROVIDED ABOVE SHALL CONSTITUTE SELLER'S SOLE LIABILITY AND BUYER'S EXCLUSIVE REMEDY FOR FAILURE OF SELLER TO MEET ITS WARRANTY OBLIGATIONS, WHETHER CLAIMS OF THE BUYER ARE BASED IN CONTRACT, IN TORT (INCLUDING NEGLIGENCE OR STRICT LIABILITY), OR OTHERWISE.

Asbestos

Federal Law requires that building or facility owners identify the presence, location and quantity of asbestos containing material (hereinafter "ACM") at work sites. Seller is not licensed to abate ACM. Accordingly, for any contract which includes the provision of Services, prior to (i) commencement of work at any site under a specific Purchase Order, (ii) a change in the work scope of any Purchase Order, the Buyer will certify that the work area associated with the Seller's scope of work includes the handling of Class II ACM, including but not limited to generator wedges and high temperature gaskets which include asbestos materials. The Buyer shall, at its expense, conduct abatement should the removal, handling, modification or reinstallation, or some or all of them, of said Class II ACM be likely to generate airborne asbestos fibers; and should such abatement affect the cost of or time of performance of the work, then Seller shall be entitled to an equitable adjustment in the schedule, price and other pertinent affected provisions of the contract.

Compliance with Nuclear Regulation

Seller's Products are sold as commercial grade Products not intended for application in facilities or activities licensed by the United States Nuclear Regulatory Commission for atomic purposes. Further certification will be required for use of the Products in any safety-related application in any nuclear facility licensed by the U.S. Nuclear Regulatory Commission.

Returning Products

Authorization and shipping instructions for the return of any Products must be obtained from Seller before returning the Products.

When return is occasioned due to Seller error, full credit including all transportation charges will be allowed.

Product Notices

Buyer shall provide the user (including its employees) of the Products with all Seller supplied Product notices, warnings, instructions, recommendations, and similar materials.

Force Majeure

Seller shall not be liable for failure to perform or delay in performance due to fire, flood, strike or other labor difficulty, act of God, act of any governmental authority or of the Buyer, riot, embargo, fuel or energy shortage, car shortage, wrecks or delays in transportation, or due to any other cause beyond Seller's reasonable control. In the event of delay in performance due to any such cause, the date of delivery or time for completion will be extended by a period of time reasonably necessary to overcome the effect of such delay.

Liquidated Damages

Contracts which include liquidated damage clauses for failure to meet shipping or job completion promises are not acceptable or binding on Seller, unless such clauses are specifically accepted in writing by an authorized representative of the Seller at its headquarters office.

Patent Infringement

Seller will defend or, at its option, settle any suit or proceeding brought against Buyer, or Buyer's customers, to the extent it is based upon a claim that any Product or part thereof, manufactured by Seller or its subsidiaries and furnished hereunder, infringes any United States patent, other than a claim of infringement based upon use of a Product or part thereof in a process, provided Seller is notified in reasonable time and given authority, information and assistance (at Seller's expense) for the defense of same. Seller shall pay all legal and court costs and expenses and court-assessed damages awarded therein against Buyer resulting from or incident to such suit or proceeding. In addition to the foregoing, if at any time Seller determines there is a substantial question of infringement of any United States patent, and the use of such Product is or may be enjoined, Seller may, at its option and expense: either (a) procure for Buyer the right to continue using and selling the Product; (b) replace the Product with non-infringing apparatus; (c) modify the Product so it becomes non-infringing; or (d) as a last resort, remove the Product and refund the purchase price, equitably adjusted for use and obsolescence. In no case does Seller agree to pay any recovery based upon its Buyer's savings or profit through use of Seller's Products whether the use be special or ordinary. The foregoing states the entire liability of Seller for patent infringement.

The preceding paragraph does not apply to any claim of infringement based upon: (a) any modification made to a Product other than by Seller; (b) any design and/or specifications of Buyer to which a Product was manufactured; or (c) the use or combination of Product with other products where the Product does not itself infringe. As to the above-identified claim situations where the preceding paragraph does not apply, Buyer shall defend and hold Seller harmless in the same manner and to the extent as Seller's obligations described in the preceding paragraph. Buyer shall be responsible for obtaining (at Buyer's expense) all license rights required for Seller to be able to use software products in the possession of Buyer where such use is required in order to perform any Service for Buyer.

With respect to a Product or part thereof not manufactured by Seller or its subsidiaries, Seller will attempt to obtain for Buyer, from the supplier(s), the patent indemnification protection normally provided by the supplier(s) to customers.

Compliance with OSHA

Seller offers no warranty and makes no representation that its Products comply with the provisions or standards of the Occupational Safety and Health Act of 1970, or any regulation issued thereunder. In no event shall Seller be liable for any loss, damage, fines, penalty or expenses arising under said Act.

Limitation of Liability

THE REMEDIES OF THE BUYER SET FORTH IN THIS CONTRACT ARE EXCLUSIVE AND ARE ITS SOLE REMEDIES FOR ANY FAILURE OF SELLER TO COMPLY WITH ITS OBLIGATIONS HEREUNDER.

NOTWITHSTANDING ANY PROVISION IN THIS CONTRACT TO THE CONTRARY, IN NO EVENT SHALL SELLER BE LIABLE IN CONTRACT, IN TORT (INCLUDING NEGLIGENCE OR STRICT LIABILITY) OR OTHERWISE FOR DAMAGE TO PROPERTY OR EQUIPMENT OTHER THAN PRODUCTS SOLD HEREUNDER, LOSS OF PROFITS OR REVENUE, LOSS OF USE OF PRODUCTS, COST OF CAPITAL, CLAIMS OF CUSTOMERS OF THE BUYER OR ANY SPECIAL, INDIRECT, INCIDENTAL OR CONSEQUENTIAL DAMAGES WHATSOEVER, REGARDLESS OF WHETHER SUCH POTENTIAL DAMAGES ARE FORESEEABLE OR IF SELLER HAS BEEN ADVISED OF THE POSSIBILITY OF SUCH DAMAGES.

THE TOTAL CUMULATIVE LIABILITY OF SELLER ARISING FROM OR RELATED TO THIS CONTRACT WHETHER THE CLAIMS ARE BASED IN CONTRACT, IN TORT (INCLUDING NEGLIGENCE OR STRICT LIABILITY) OR OTHERWISE, SHALL NOT EXCEED THE PRICE OF THE PRODUCT OR SERVICES ON WHICH SUCH LIABILITY IS BASED.