

RFB4 Series Floor Box with FloorPort Activation Cover.

Recessed Floor Boxes for Concrete & Wood Floors

Resource RFB® Series of Floor Boxes are versatile recessed activation solutions that provide power, communication and/or audio/video services to open space areas, or directly to workstations.

Resource RFB Series Floor Boxes are available in two- to six-gang models with a variety of aesthetic cover options including colors and profiles available.

Resource RFB Series Floor Boxes have many applications, including schools, financial institutions, commercial office buildings, hospitality and residences.

PRODUCTS: RFB2, RFB2-SS, RFB2-OG, RFB4, RFB4-SS, RFB4-4DB, RFB4-CI-1, RFB4-CI-NA, RFB6, RFB6-OG

Features & Benefits

- **RFB6 has independent wiring compartments that allow capacity for up to six duplex receptacles and/or communication services.** Reduces overall cost by providing for most cabling requirements.
- **The RFB4 has three versions for various applications.** A cast iron version to meet on grade requirements, a steel version to reduce installation cost on above grade floors, and a shallow steel version that provides flexibility with varying concrete depths.
- **Fully adjustable before and after the concrete pour.** Labor savings by adapting to various pour depths and conditions.
- **Range of conduit sizes.** Allows for most conduit schemes, even feed through capability, which saves time and money during installation. KOs range from 1/2" to 2" trade size.
- **Triple service boxes.** Accommodate power, communication and/or audio/video devices which reduces the need for multiple boxes.
- **Installs in both concrete and wood floors.** Provides the first recessed wood floor box for both commercial and residential applications.
- **RFB2-SS & RFB4-SS design allows for pass-around tunneling.** Flexible design of shallow floor boxes allows adjacent compartments to be wired together.
- **FloorPort Activation Covers.** Provides TopGuard protection from water, dirt and debris plus added strength and durability. Available in brushed aluminum and five decorative powder coat finishes: Black, Brass, Nickel, Gray and Bronze.
- **Wide variety of mounting brackets.** Can adapt to most power and communication needs. Reduces overall life cycle cost.
- **2" Conduit Hub.** By using 2HUB with the RFB6 Series Floor Box (sold separately) a greater capacity of pre-terminated cables can be brought in the a shallower box. Increasing the functionality and reducing concrete pours.
- **Lightweight "slab-on-grade" version.** Special fusion-bonded epoxy corrosion resistant paint finish allows for slab-on-grade use without the weight of cast iron material.
- **Datacom connectivity options.** Accepts industry standard and proprietary devices from a wide range of manufacturers to provide a seamless and aesthetically pleasing interface for voice, data, and A/V applications at the point-of-use. A wide selection of data and adapter options are available for use with Ortronics® TracJack and Series II devices.
- **Buy America Act/NAFTA versions.** FloorPort Service Fittings are available in versions that meet the Buy America Act/NAFTA requirements.

Vertical Markets

- Commercial
- Education
- Entertainment
- Healthcare
- Retail

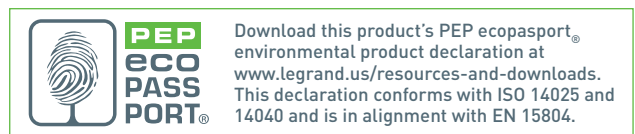

Compliance

cULus Listed Metallic Outlet Boxes for tile, terrazzo, carpet and wood floors. File E2961 Guide QCIT



Protection from water, dirt, and debris.

Resource RFB® Series Floor Boxes with Rectangular Activations Selection Guide

Box Model	Install Floor Type:		Box Type:	Box Capacity:	Depth Behind Plates:	A/V Compatibility	Trade Size Conduit Feed:	Cover Style	Country of Origin	Adjustability
	Concrete	Wood								
RFB2	Yes	Yes	Above Grade	2 Gangs	3" [76mm]	Legrand AVIP, Altinex Intera, Extron AAP, MAAP & Decorator, Ortronics Series II	1/2" – 1 1/4"	FloorPort	Mexico	Fully Adjustable
RFB2-SS	Yes	Yes	Above Grade	2 Gangs	3" [76mm]		1/2" – 3/4"	FloorPort	Mexico	
RFB2-OG	Yes	Yes	On-Grade	2 Gangs	3" [76mm]		1/2" – 1 1/4"	FloorPort	Mexico	
RFB4	Yes	No	Above Grade	4 Gangs	2" [51mm]		1/2" – 1 1/4"	FloorPort	Mexico	
RFB4-4DB	Yes	No	Above Grade	4 Gangs	2" [51mm]		1/2" – 1 1/4"	FloorPort	Mexico	
RFB4-SS	Yes	No	Above Grade	4 Gangs	2" [51mm]		1/2" – 1"	FloorPort	Mexico	
RFB4-CI-1	Yes	No	On-Grade	4 Gangs	2" [51mm]		1" – 1 1/4"	FloorPort	China	
RFB4-CI-NA	Yes	No	On-Grade	4 Gangs	2" [51mm]		1" – 1 1/4"	FloorPort	USA	
RFB6	Yes	Yes	Above Grade	6 Gangs	3 1/4" [83mm]		3/4" – 2"	FloorPort	Mexico	
RFB6-OG	Yes	Yes	On-Grade	6 Gangs	3 1/4" [83mm]		3/4" – 2"	FloorPort	Mexico	

NOTE: Pricing may vary depending on country of origin. Consult your local sales representative for more information.

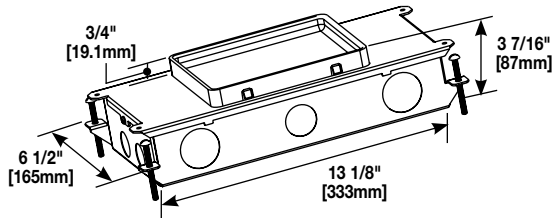
RFB2 Series Floor Boxes Ordering Information
RFB2-OG

Two-Compartment Box – For use On Grade. Fully adjustable with tunnel compartment. Supplied with one (1) duplex receptacle mounting plate, and one (1) communication mounting plate (RFB22AB). Other device plates sold separately.

NOTE: RFB2-OG for on-grade applications is painted with a fusion-bonded epoxy designed for use on metal reinforcement bar and related accessories before encapsulating in concrete.

Country of Origin: Mexico

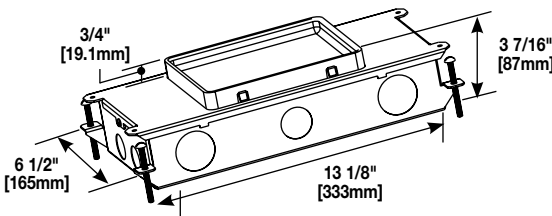
RFB2

Two-Compartment Box – For use in either concrete or wood floors. Fully adjustable with tunnel compartment. Supplied with one (1) duplex receptacle mounting plate, and one (1) communication mounting plate (RFB22AB). Other device plates sold separately.

Country of Origin: Mexico

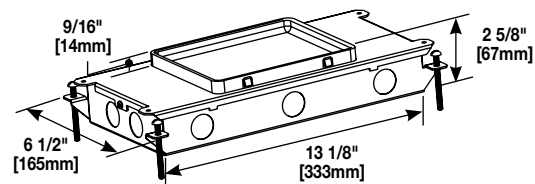
RFB2-SS

Two-Compartment Shallow Stamped Steel Floor Box – For use in either concrete or wood floors. Fully adjustable with tunnel compartment. Supplied with one (1) duplex receptacle mounting plate, and one (1) communication mounting plate (RFB22AB). Other device plates sold separately.

Country of Origin: Mexico

RFB2 Series Floor Boxes Compartment Capacities/Knockout Locations & Sizes

RFB2 & RFB2-OG

Power or Data
50.2 cu. in. [822.6 ml]
Each Side

Top View

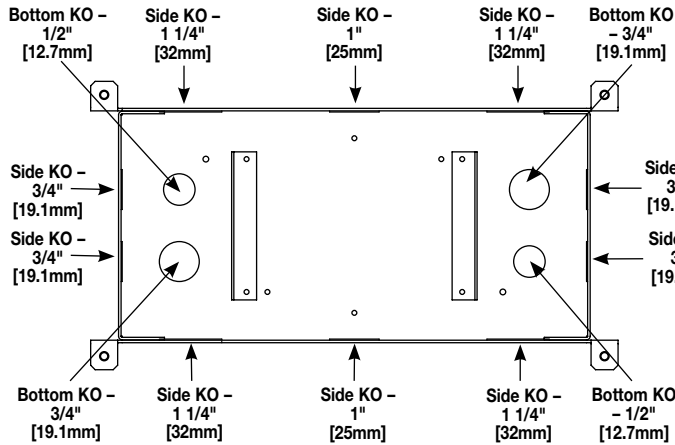

RFB2-SS

Power or Data
38.0 cu. in. [622.7 ml]
Each Side

Top View

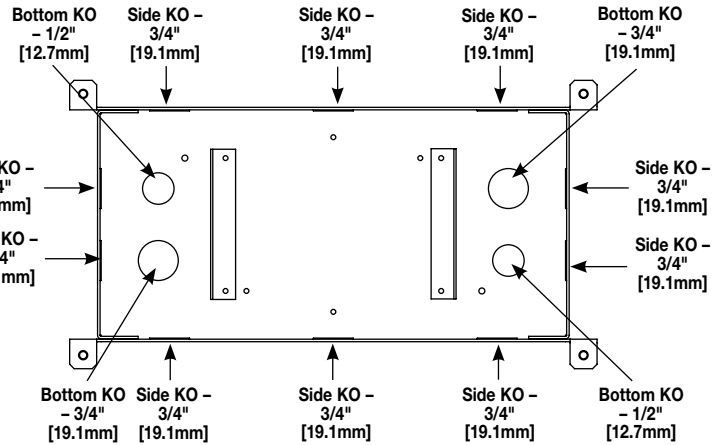

RFB2 Series Floor Box Accessories Ordering Information

RFB2DP

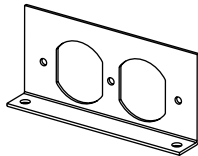

Internal Duplex Receptacle Bracket – Accepts standard 15 Amp & 20 Amp Duplex Receptacles.

Country of Origin: Mexico

RFB2RT

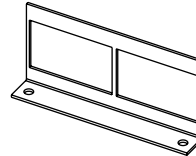

Internal Communication Bracket – Includes Two (2) adapters to accept Ortronics® TracJack devices, and Two (2) adapters to accept Ortronics® Series II devices. (sold separately)

Country of Origin: Mexico

RFB2B

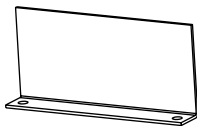

Internal Blank Bracket – Plate used to close off unused gangs.

Country of Origin: Mexico

RFB2EXT

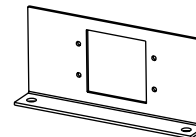

Internal Audio/Video Bracket – Accepts two (2) Legrand AVIP or Extron® Electronics MAAP Series devices. (sold separately)

Country of Origin: Mexico

RFB2GFI

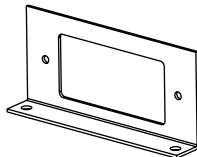

Internal GFI or Decorator Style Receptacle Bracket – Accepts standard GFCI or Decorator Style Receptacles, Communication or A/V Devices.

Country of Origin: Mexico

RFB2-AAP

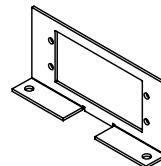

Internal Audio/Video Bracket – Accepts Two (2) Extron® Electronics AAP Series devices. (sold separately)

Country of Origin: Mexico

RFB22AB

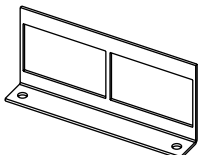

Internal Communication Bracket – Includes two (2) adapters to accept Wiremold CM2 Series Open System communication inserts. (sold separately)

Country of Origin: Mexico

RFB2 Series Floor Box Accessories Ordering Information

RFBKIT

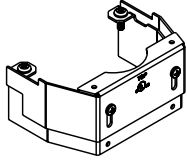

Barrier Kit – Barrier kit used to separate power and communication wires in partition feed covers. Supplied with base and three extensions to adjust to cover height. Kit should be used on RFB2, RFB2-OG, RFB2-SS, RFB4 and RFB4-SS Floor Boxes. Kits are sold separately.

Country of Origin: USA

FP-CTR

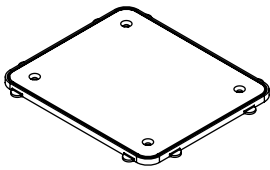

Bare Concrete & Terrazzo Ring – Nonmetallic ring for use on bare polished concrete and terrazzo floor applications.

Country of Origin: USA

PKER

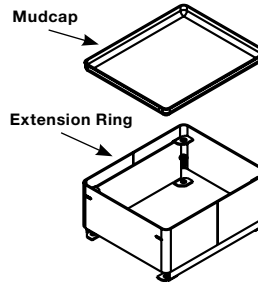

Extensions – Attaches to preset to add height to preset. Can be field installed.

Extension	Height Above Preset "A"
PKER-10	1" [25mm]
PKER-15	1 1/2" [38mm]
PKER-20	2" [51mm]
PKER-25	2 1/2" [64mm]
PKER-30	3" [76mm]

Country of Origin: USA

S3AXB

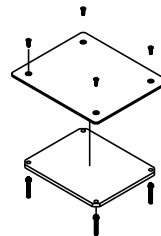

Blanking Plate – Aluminum top plate with steel support plate and four (4) adjusting screws.

Country of Origin: USA

RFB4 & RFB4-4DB Floor Box Ordering Information

RFB4

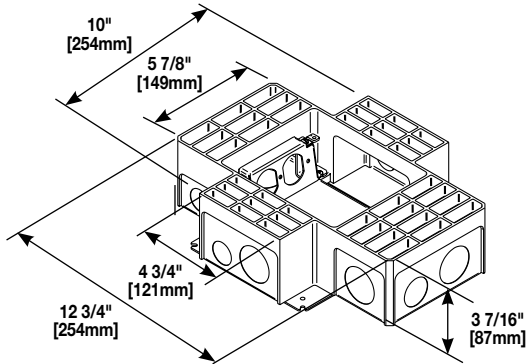

Four-Compartment Combination Box – 12 3/4" L x 10" W x 3 7/16" D [324mm x 254mm x 87mm]. Fully adjustable with tunnel compartment and two receptacle brackets. **Tunneling from end power compartment to end power compartment only.** Communication brackets not included. See "Accessories".

NOTE: Only for use in concrete floors.

Country of Origin: Assembled in Mexico from components made in the USA

RFB4-4DB

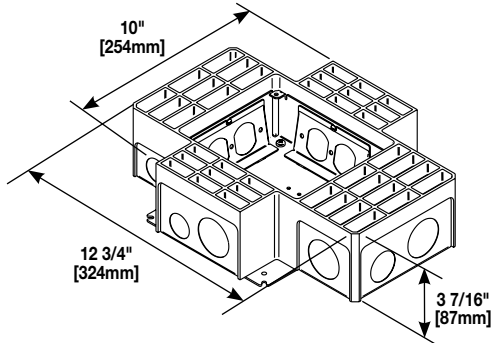

Four-Compartment Box – Includes four duplex receptacle brackets. 12 3/4" L x 10" W x 3 7/16" D [324mm x 254mm x 87mm]. Fully adjustable. **Tunneling from adjacent or opposite compartments only, (not cross compartments).** Tunneling can be set to feed all four compartments from one conduit in a single-service application.

NOTE: Only for use in concrete floors.

Country of Origin: Assembled in Mexico from components made in the USA

RFB4 & RFB4-4DB Floor Box Compartment Capacities and Knockout Locations and Sizes

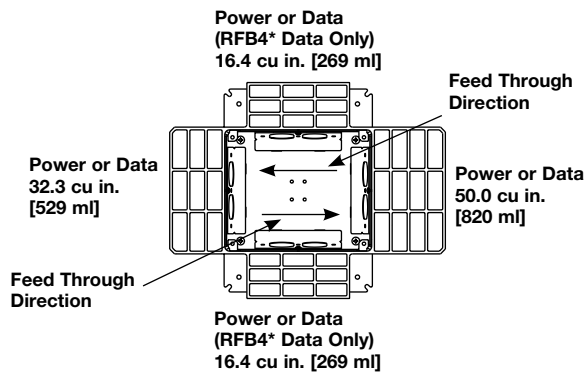

FOR RFB4

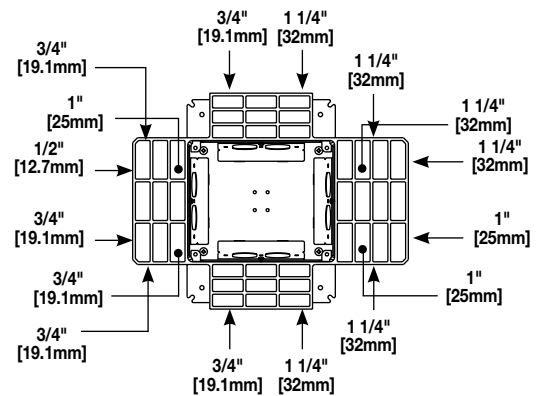

Indicates Bottom KO.

*No feed through to opposite data compartment on RFB4.

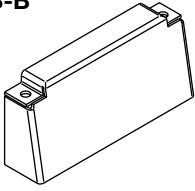
RFB4 & RFB4-4DB Floor Box Accessories Ordering Information
RFB-B

Internal Blank Bracket – Power compartments only. Used to close off unused gangs.

Country of Origin: USA

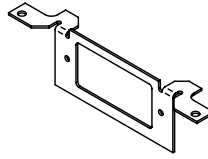
DTB-2-DECORA

Communication Bracket – Decorator style opening for decorator style 106 Adapter.

Country of Origin: Mexico

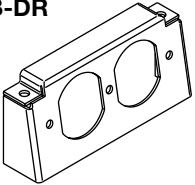
RFB-DR

Internal Duplex Bracket – Accepts standard 15 Amp & 20 Amp Duplex Receptacles.

Country of Origin: USA

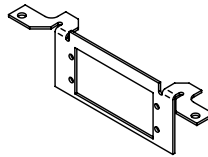
DTB-2-AAP

Internal Audio/Video Bracket – Accepts two (2) Extron® Electronics AAP devices (sold separately)

Country of Origin: Mexico

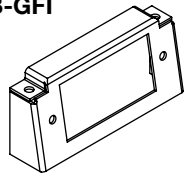
RFB-GFI

Internal GFI Bracket – Accepts standard GFCI or Decorator Style Receptacles, Communication or Audio/Video Devices.

Country of Origin: USA

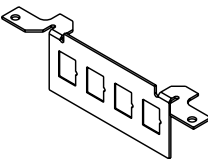
DTB-2-4TKO

Communication Bracket – Four (4) RJ keystone opening knockouts. Use as blank plate or for up to four (4) RJ openings.

NOTE: Opening dimension is 9/16" x 3/4" (14.3mm x 19.1mm).

Country of Origin: USA

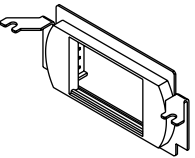
RFB4-LPB

Communication Bracket – Activate™ low profile adapter included. Wiremold CM Series Open System inserts sold separately.

Country of Origin: Mexico

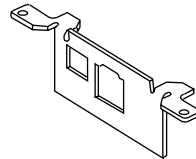
DTB-2-DT

Communication Bracket – With one IBM Type II opening and one keystone opening (devices not included).

NOTE: For RFB4 only.

Country of Origin: Mexico

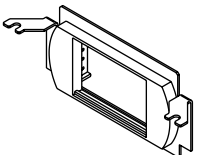
RFB4-LPBS2

Communication Bracket – Ortronics® Series II Low profile adapter included.

Country of Origin: Mexico

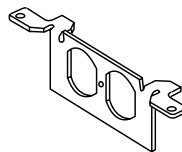
DTB-2-SD

Communication Bracket – With duplex opening for use with 106 Adapter (sold separately) (devices not included).

NOTE: For RFB4 only.

Country of Origin: Mexico

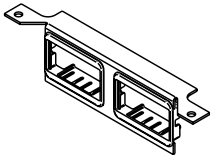
DTB-2-2AB

Communication Bracket – Two (2) 2A size adapters included. Wiremold CM2 Series Open System inserts, sold separately.

Country of Origin: Mexico

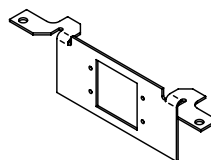
DTB-EXT

Internal Audio/Video Bracket – Accepts two (2) Legrand AVIP or Extron Electronics MAAP devices (sold separately).

NOTE: For RFB4 only.

Country of Origin: Mexico

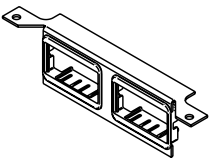
DTB-2-RT

Communication Bracket – Ortronics® AB2TJ TracJack and ABS2 Series II adapters included.

Country of Origin: Mexico

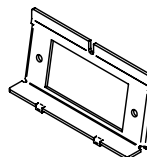
RFB-GFI-4DB

Internal GFCI Bracket – Accepts standard GFCI or Decorator style receptacles, communications or A/V devices.

NOTE: For RFB4-4DB only.

Country of Origin: USA

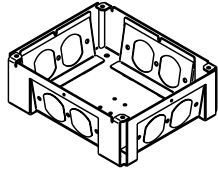
RFB4 & RFB4-4DB Floor Box Accessories Ordering Information
RFB-WTB

Conversion Kit – To convert the RFB4 Box to a RFB4-4DB Box.

NOTE: For RFB4 & RFB4-4DB.

Country of Origin: Mexico

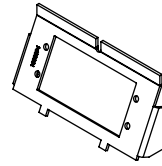
WTB-AAP

Internal Audio/Video Bracket – Accepts two (2) Extron Electronics AAP Series Devices (sold separately).

NOTE: For RFB4-4DB only.

Country of Origin: USA

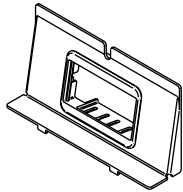
WTB-2-AB

Communication Bracket – One 2A adapter included. Wiremold CM2 Series Open System inserts sold separately.

NOTE: For RFB4-4DB only.

Country of Origin: Mexico

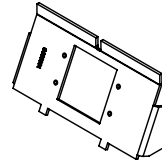
WTB-MAAP

Internal Audio/Video Bracket – Accepts two (2) Legrand AVIP or Extron® Electronics MAAP Series Devices (sold separately).

NOTE: For RFB4-4DB only.

Country of Origin: USA

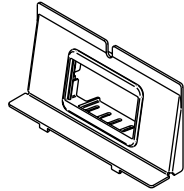
WTB-2-RT

Communication Bracket – Ortronics® AB2TJ TracJack and ABS2 Series II adapters included.

NOTE: For RFB4-4DB only.

Country of Origin: Mexico

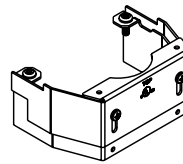
RFBKIT

Barrier Kit – Barrier kit used to separate power and communication wires in partition feed covers. Supplied with base and three extensions to adjust to cover height. Kit should be used on RFB2, RFB2-OG, RFB2-SS, RFB4 and RFB4-SS Floor Boxes. Kits are sold separately.

Country of Origin: USA

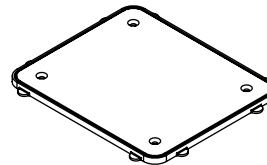
FP-CTR

Bare Concrete & Terrazzo Ring – Nonmetallic ring for use on bare polished concrete and terrazzo floor applications.

Country of Origin: USA

RFB4-CI-1 & RFB4-CI-NA Floor Box Ordering Information

RFB4-CI-1

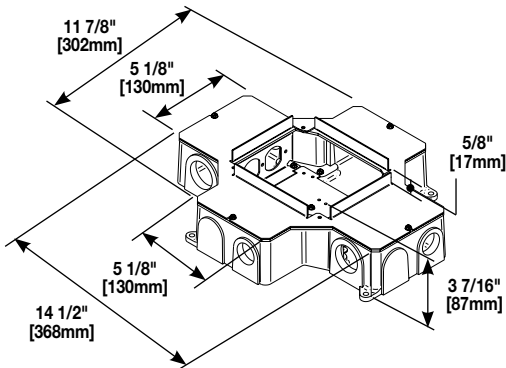

Four-Compartment Cast Iron Box – 14 1/2" L x 11 7/8" W x 3 7/16" D [368mm x 302mm x 87mm]. Fully adjustable with tunnel compartment and two receptacle brackets. **Feed through from adjacent or opposite compartments only, (not cross compartments).** Communication brackets not included. See "Accessories".

NOTE: Only for use in concrete floors.
All boxes and activations are sold separately.

Country of Origin: China

RFB4-CI-NA

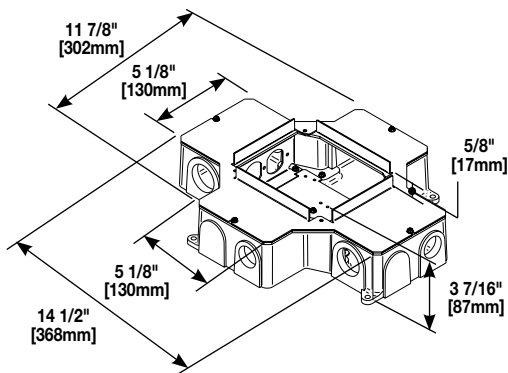

Four-Compartment Cast Iron Box – 14 1/2" L x 11 7/8" W x 3 7/16" D [368mm x 302mm x 87mm]. Fully adjustable with tunnel compartment and two receptacle brackets. **Feed through from adjacent or opposite compartments only, (not cross compartments).** Communication brackets not included. See "Accessories".

NOTE: Only for use in concrete floors.
All boxes and activations are sold separately.

Country of Origin: USA

RFB4-CI-1 & RFB4-CI-NA Floor Box Compartment Capacities and Knockout Locations and Sizes

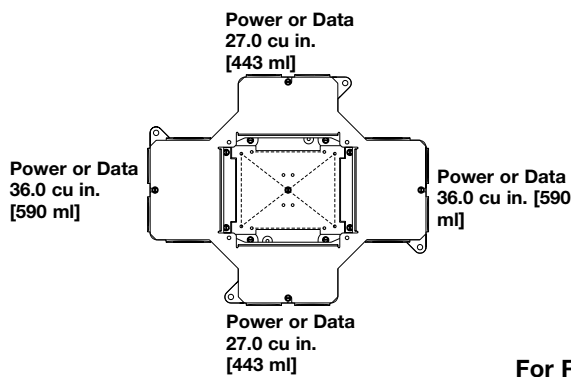

For RFB4-CI-1 & RFB4-CI-NA

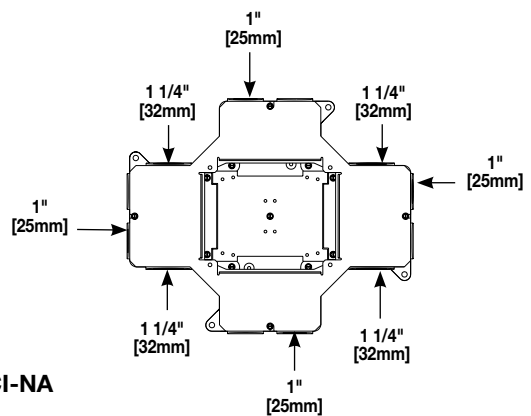

NOTE: Pricing varies depending on country of origin. Consult your local sales representative for more information.

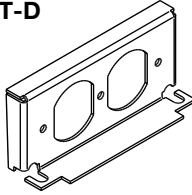
RFB4-CI-1 & RFB4-CI-NA Floor Box Accessories Ordering Information
CIHT-D

Internal Duplex Receptacle Bracket – Accepts standard 15 Amp & 20 Amp Duplex Receptacles.

Country of Origin: USA

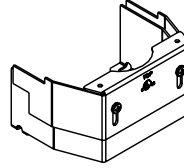
RFB4CIKIT

Barrier Kit – Barrier kit used with RFB4-CI Floor Boxes. Kits are sold separately.

Country of Origin: USA

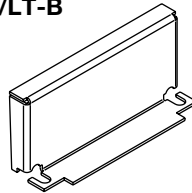
CIH/LT-B

Internal Blank Bracket – Used to close off unused gangs.

Country of Origin: USA

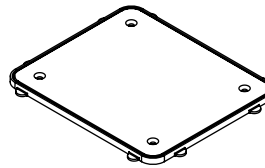
FP-CTR

Bare Concrete & Terrazzo Ring – Nonmetallic ring for use on bare polished concrete and terrazzo floor applications.

Country of Origin: USA

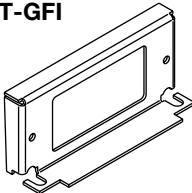
CIHT-GFI

Internal GFI Device Bracket – Accepts standard GFCI or Decorator Style Receptacles, Communication or Audio/Video Devices.

Country of Origin: USA

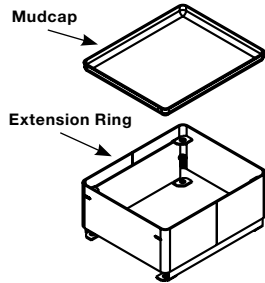
PKER

Extensions – Attaches to preset to add height to preset. Can be field installed.

Extension	Height Above Preset "A"
PKER-10	1" [25mm]
PKER-15	1 1/2" [38mm]
PKER-20	2" [51mm]
PKER-25	2 1/2" [64mm]
PKER-30	3" [76mm]

Country of Origin: USA

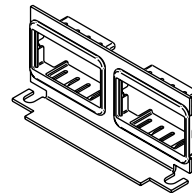
CILT-2AB

Communication Bracket – Communication bracket with two 2A size Activate adapters included. Accepts Wiremold CM2 Series Open System communication modules (sold separately).

Country of Origin: Mexico

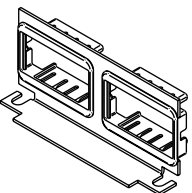
CILT-2-RT

Communication Bracket – Communication bracket with Ortronics AB2TJ TracJack and ABS2 Series II adapters included. Accepts Ortronics workstation connectivity outlets and modular inserts.

Country of Origin: Mexico

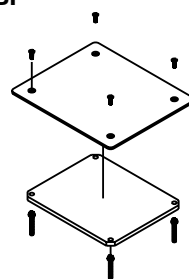
S3AXB

Blanking Plate – Aluminum top plate with steel support plate and four (4) adjusting screws.

Country of Origin: USA

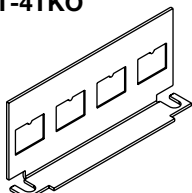
CILT-4TKO

Communication Bracket – Communication bracket with four (4) RJ opening knockouts. Use as blank plate or for up to four RJ openings.

NOTE: Opening dimension is 9/16" x 3/4" [14.3mm x 19.1mm].

Country of Origin: USA

RFB4-SS Floor Box Ordering Information

RFB4-SS

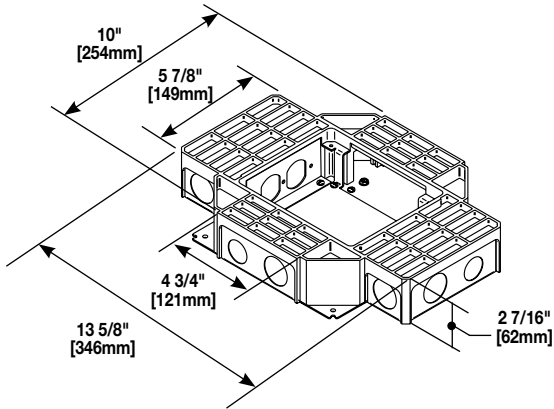

Four-Compartment Shallow Stamped Steel Box –

13 5/8" L x 10" W x 2 7/16" D [346mm x 254mm x 62mm]. Fully adjustable with tunnel compartment and two receptacle brackets.

Feed through tunneling to adjacent compartments only.

Tunneling can be set to feed all four compartments from one conduit in a single-service application. Communication brackets not included. See "Accessories".

NOTE: Only for use in concrete floors.

All boxes and activations are sold separately.

Country of Origin: Assembled in Mexico from components made in the USA

RFB4-SS Floor Box Compartment Capacities and Knockout Locations and Sizes

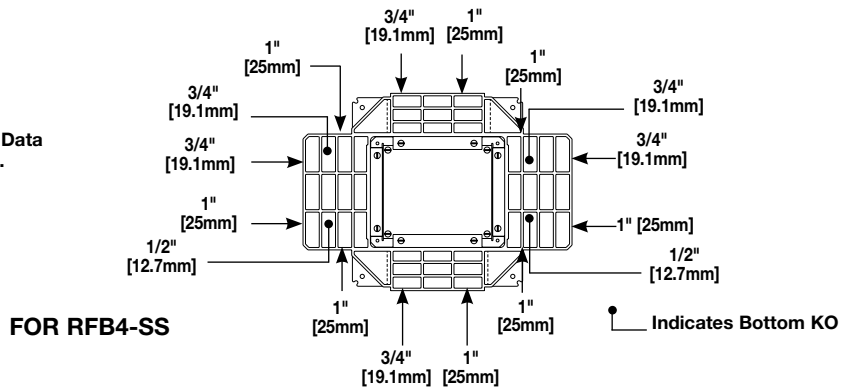
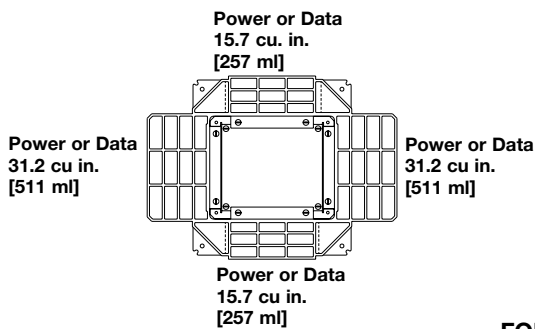

RFB4-SS Floor Box Accessories Ordering Information

RFB-B-SS

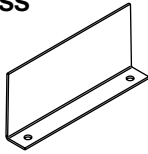

Internal Blank Bracket – Used to close off unused gangs.

Country of Origin: Mexico

RFB-RB-SS

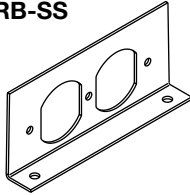

Internal Duplex Receptacle Bracket – Accepts standard 15 Amp & 20 Amp Duplex Receptacles.

Country of Origin: Mexico

RFB-GFI-SS

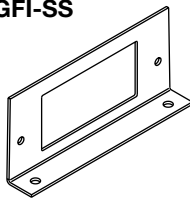

Internal GFI Receptacle Bracket – Accepts standard GFCI & Decorator style Receptacles Communication or Audio/Video Devices.

Country of Origin: Mexico

RFB-2AB-SS

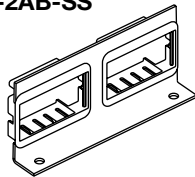

Internal Bracket – Two Pass & Seymour Activate adapters included. Wiremold CM Series Open System inserts sold separately.

Country of Origin: Mexico

RFB-2-SSRT

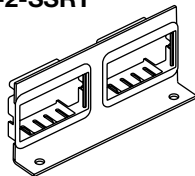

Communication Bracket – Ortronics® AB2TJ TracJack and ABS2 Series II adapters included.

Country of Origin: Mexico

RFB-4TKO-SS

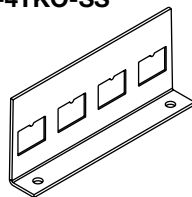

Internal Bracket – Four RJ Keystone opening knockouts. Use as blank plate or for up to four RJ openings.

NOTE: Opening dimension is 9/16" x 3/4"
[14.3mm x 19.1mm].

Country of Origin: Mexico

RFB4-SS-AAP

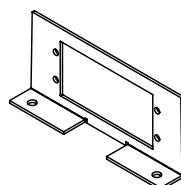

Internal Audio/Video Bracket – Accepts two (2) Extron Electronics AAP Series Devices. (Sold separately)

Country of Origin: Mexico

RFB4-SS-MAAP

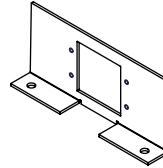

Internal Audio/Video Bracket – Accepts two Extron® Electronics MAAP Series Devices. (Sold separately)

Country of Origin: Mexico

RFBKIT

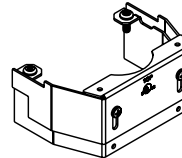

Barrier Kit – Barrier kit used to separate power and communication wires in partition feed covers. Supplied with base and three extensions to adjust to cover height. Kit should be used on RFB2, RFB2-OG, RFB2-SS, RFB4 and RFB4-SS Floor Boxes. Kits are sold separately.

Country of Origin: USA

FP-CTR

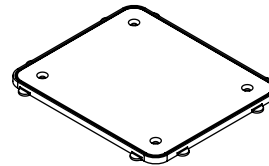

Bare Concrete & Terrazzo Ring – Nonmetallic ring for use on bare polished concrete and terrazzo floor applications.

Country of Origin: USA

PKER

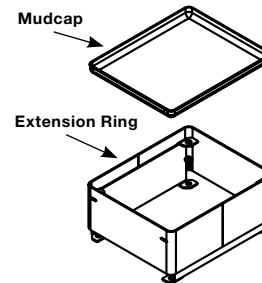

Extensions – Attaches to preset to add height to preset. Can be field installed.

Extension	Height Above Preset "A"
PKER-10	1" [25mm]
PKER-15	1 1/2" [38mm]
PKER-20	2" [51mm]
PKER-25	2 1/2" [64mm]
PKER-30	3" [76mm]

Country of Origin: USA

S3AXBP

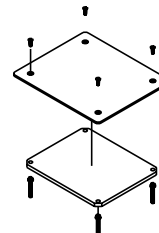

Blanking Plate – Aluminum top plate with steel support plate and four (4) adjusting screws.

Country of Origin: USA

RFB6 Series Floor Box Ordering Information

RFB6

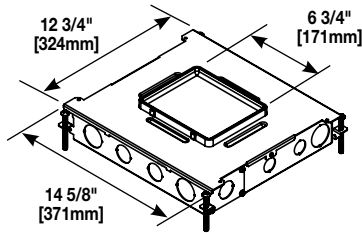

Six-Compartment Box – For use in either concrete or wood floors. Fully adjustable with tunnel compartment. Supplied with two (2) duplex mounting plates, two (2) communication mounting plates (RFB62A), and (2) blank mounting plates. Other plates sold separately.

Country of Origin: Mexico

RFB6-OG

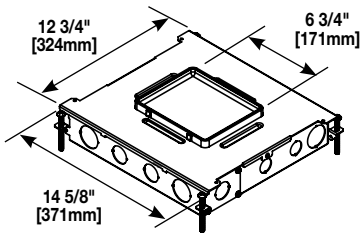

Six-Compartment On-Grade Box – For use in either concrete or wood floors. Fully adjustable with tunnel compartment. Supplied with two (2) duplex mounting plates, two (2) communication mounting plates (RFB62A), and (2) blank mounting plates. Other plates sold separately.

Country of Origin: Mexico

RFB6 Series Floor Box Compartment Capacities and Knockout Locations and Sizes

COMPARTMENT CAPACITIES

- A = Power or Data 52 in² [852ml]
- B = Power or Data 23 in² [376ml]

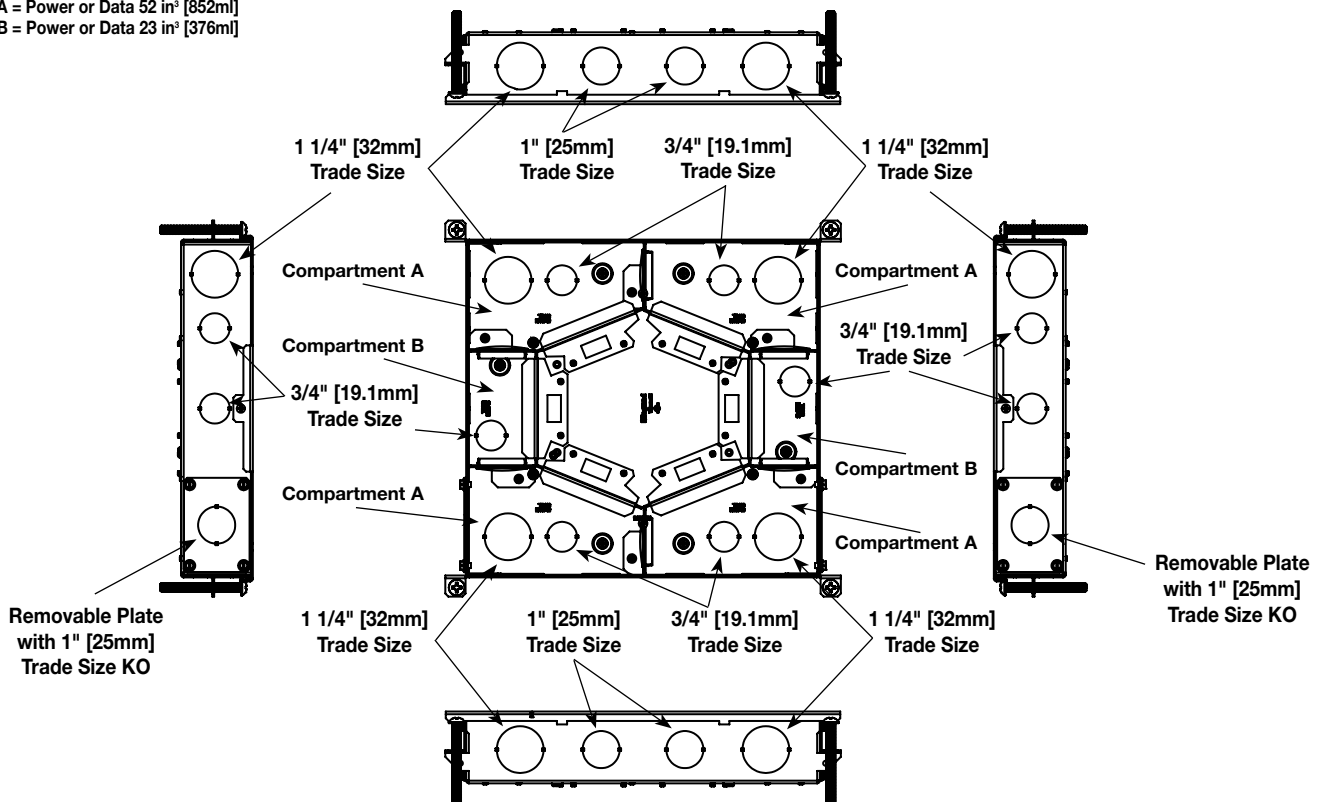

Feed through is accomplished through removable plugs.
2-inch HUB feed through accomplished by removing divider.

RFB6 Series Floor Box Accessories Ordering Information

RFB6DP

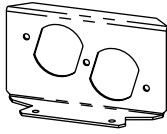

Internal Duplex Receptacle Bracket – Accepts standard 15 & 20 Amp Duplex Receptacles.

Country of Origin: USA

RFB6B

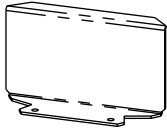

Internal Blank Bracket – Closes off unused gangs.

Country of Origin: USA

RFB6-GFI

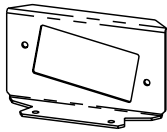

Internal GFI or Decorator Style Receptacle Bracket – Accepts standard GFCI & Decorator Style Receptacles, Communication or A/V Devices.

Country of Origin: USA

RFB6S1

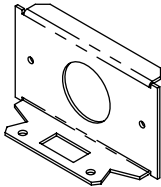

Internal Single Receptacle Bracket – Receptacle opening 1 3/8" (35mm).

Country of Origin: USA

RFB6S2

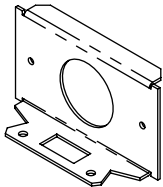

Internal Single Receptacle Bracket – Receptacle opening 1 9/16" (40mm).

Country of Origin: USA

RFB6RT

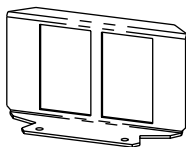

Internal Communication Bracket – Includes one (1) adapter to accept Ortronics TracJack devices, and one (1) adapter to accept Ortronics Series II devices (sold separately).

Country of Origin: USA

RFB6EXT

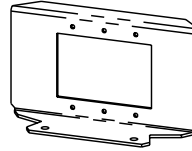

Internal Audio/Video Bracket – Accepts three (3) Legrand AVIP or Extron Electronics MAAP Series devices (sold separately).

Country of Origin: USA

RFB62A

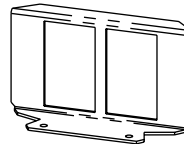

Internal Communication Bracket – Includes two (2) adapters to accept Wiremold CM2 Series Open System communication inserts (sold separately).

Country of Origin: USA

RFB6-AAP

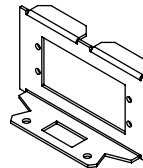

Internal A/V Bracket – Accepts two (2) Extron Electronics AAP Series Devices (sold separately).

Country of Origin: USA

FP-CTR

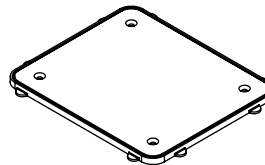

Bare Concrete & Terrazzo Ring – Nonmetallic ring for use on bare polished concrete and terrazzo floor applications.

Country of Origin: USA

PKER

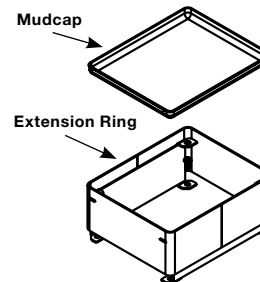

Extensions – Attaches to preset to add height to preset. Can be field installed.

Extension	Height Above Preset "A"
PKER-10	1" [25mm]
PKER-15	1 1/2" [38mm]
PKER-20	2" [51mm]
PKER-25	2 1/2" [64mm]
PKER-30	3" [76mm]

Country of Origin: USA

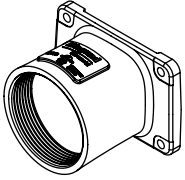
RFB6 Series Floor Box Accessories Ordering Information**2HUB**

2" Conduit Transition Fitting – Trade size 2" die cast zinc conduit fitting allows for 2" conduit to transition into a shallow box design. Includes: die cast fitting gasket. Accepts standard 2" threaded conduit or trade size EMT and PVC conduit fittings.

Country of Origin: USA

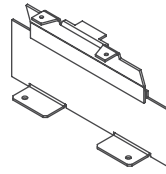
RFB6KIT

Barrier Kit – Used to separate power and communication services. Used in combination with FloorPort Furniture Feed Covers (FPFFTC Series). Covers sold separately.

Country of Origin: USA

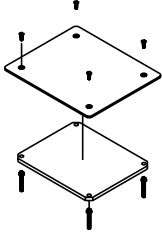
S3AXBP

Blanking Plate – Aluminum top plate with steel support plate and four (4) adjusting screws.

Country of Origin: USA

FloorPort Series Cover Assemblies for Resource RFB® Series Floor Boxes

FLOORPORT PART NUMBER CONFIGURATOR								
FP	B		TC		NK			
FloorPort Cover	Blank Top	B	Tile (Flangeless)	T	Nickel	NK	Bronze	BZ
	Cutout Top	C	Tile/Carpet (Flanged)	TC	Brass	BS	Gray	GY
	Furniture Feed	FF			Black	BK	Brushed Aluminum	AL

FloorPort Series Flanged Cover Assemblies Ordering Information

FPCTCBK
FPCTCBZ
FPCTCBS
FPCTCNK
FPCTCAL
FPCTCGY

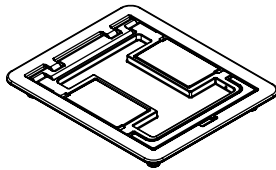

Cutout Cover Assembly –
 Flanged cover for use in tile or carpet installation. Die-cast aluminum assembly available in black (BK), bronze (BZ), brass (BS), nickel (NK), gray (GY), or brushed aluminum (AL). Insert in lid allows for carpet or tile cutouts to match finished floor.

Country of Origin: India

FPFCTCBK
FPFCTCBZ
FPFCTCBS
FPFCTCNK
FPFCTCAL
FPFCTGY

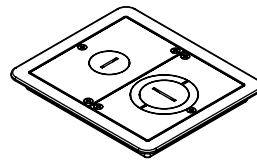

Furniture Feed Cover Assembly –
 Flanged cover for use in tile or carpet installation. Die-cast aluminum assembly available in black (BK), bronze (BZ), brass (BS), nickel (NK), gray (GY), or brushed aluminum (AL). Provided with one 1" trade size screw plug for power or communication type cabling and one combination 1 1/4" and 2" trade size screw plug for communication type cabling. Allows for feeding both power and communication cabling.

Country of Origin: China

FPBTCBK
FPBTCBZ
FPBTCBS
FPBTCNK
FPBTCAL
FPBTCGY

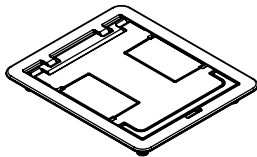

Blank Cover Assembly –
 Flanged cover for use in tile or carpet installation. Die-cast aluminum assembly available in black (BK), bronze (BZ), brass (BS), nickel (NK), gray (GY), or brushed aluminum (AL). Lid area is flush with the finished floor, no cutouts provided.

Country of Origin: India

FloorPort Series Flangeless Cover Assemblies Ordering Information

FPCTBK
FPCTBZ
FPCTBS
FPCTNK
FPCTAL
FPCTGY

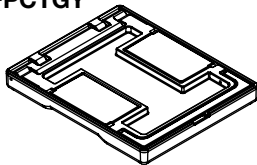

Cutout Cover Assembly –
 Flangeless cover for use in tile installations. Die-cast aluminum assembly available in black (BK), bronze (BZ), brass (BS), nickel (NK), gray (GY), or brushed aluminum (AL). Insert in lid allows for tile cutouts to match finished floor.

Country of Origin: India

FPFCTBK
FPFCTBZ
FPFCTBS
FPFCTNK
FPFCTAL
FPFCTGY

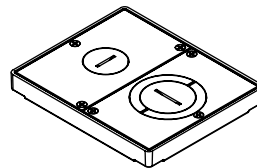

Furniture Feed Cover Assembly –
 Flangeless cover for use in tile installations. Die-cast aluminum assembly available in black (BK), bronze (BZ), brass (BS), nickel (NK), gray (GY), or brushed aluminum (AL). Provided with one 1" trade size screw plug for power or communication type cabling and one combination 1 1/4" and 2" trade size screw plug for communication type cabling. Allows for feeding both power and communication cabling.

Country of Origin: China

FPBTBK
FPBTBZ
FPBTBS
FPBTNK
FPBTAL
FPBTGY

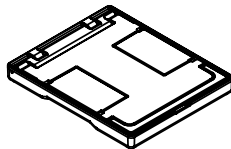

Blank Cover Assembly –
 Flangeless cover for use in tile installations. Die-cast aluminum assembly available in black (BK), bronze (BZ), brass (BS), nickel (NK), gray (GY), or brushed aluminum (AL). Lid area is flush with the finished floor, no cutouts provided.

Country of Origin: India

NOTE: Pricing varies depending on country of origin. Consult your local sales representative for more information.

North America Made FloorPort Series Cover Assemblies for Resouce RFB® Series Floor Boxes

FLOORPORT PART NUMBER CONFIGURATOR										
FP	B		TC		NK			NA		
FloorPort Cover	Blank Top	B	Tile (Flangeless)	T	Nickel	NK	Bronze	BZ	North America Made	NA
	Cutout Top	C	Tile/Carpet (Flanged)	TC	Brass	BS	Gray	GY		
	Furniture Feed	FF			Black	BK	Brushed Aluminum	AL		

North America Made FloorPort Series Flanged Cover Assemblies Ordering Information

FPCTCBK-NA
FPCTCBZ-NA
FPCTCBS-NA
FPCTCNK-NA
FPCTCGY-NA

Cutout Cover Assembly –
 Flanged cover for use in tile or carpet installation. Die-cast aluminum assembly available in black (BK), bronze (BZ), brass (BS), nickel (NK) or gray (GY). Insert in lid allows for carpet or tile cutouts to match finished floor.

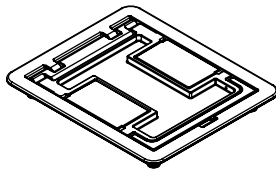

Country of Origin: USA

FPBTCBK-NA
FPBTCBZ-NA
FPBTCBS-NA
FPBTCNK-NA
FPBTCGY-NA

Blank Cover Assembly –
 Flanged cover for use in tile or carpet installation. Die-cast aluminum assembly available in black (BK), bronze (BZ), brass (BS), nickel (NK) or gray (GY). Lid area is flush with the finished floor, no cutouts provided.

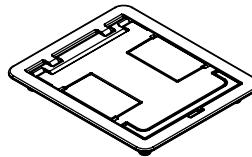

Country of Origin: USA

NOTE: Pricing varies depending on country of origin. Consult your local sales representative for more information.

LOAD CAPACITIES FOR FLOORPORT COVER ASSEMBLIES	
CATALOG NUMBERS	MAXIMUM LOAD IN POUNDS
FPCTC	1000
FPBTC	750
FPFFTC	1000
FPCT	1000
FPBT	750
FPFFT	1000

NOTE: Load applied through a 2" [51mm] mandrel in center of service fitting. Loads above are static loads only and do not pertain to rolling loads.

NOTE: All brand and product names referenced in this document are registered trademarks or trademarks of their respective holders.

NOTE: The paper used to print this document is an environmentally responsible paper with 10% post consumer waste, with FSC and SFI Chain of Custody certifications, Lacey Act compliant. 100% of the electricity used to manufacture Flo sheets is generated with Green-e certified renewable energy.

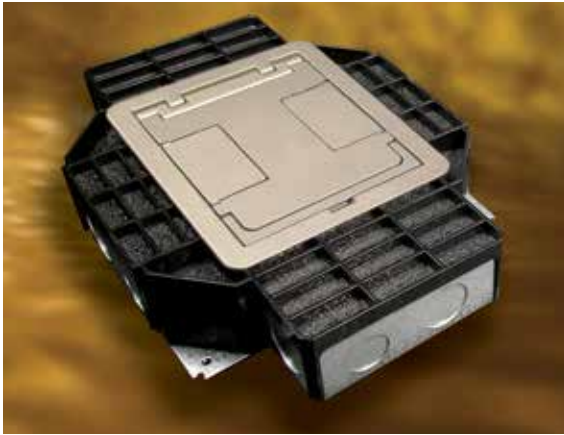

RFB4 Series Floor Box with FloorPort Activation Cover.

Recessed Floor Boxes for Concrete & Wood Floors

Resource RFB® Series of Floor Boxes are versatile recessed activation solutions that provide power, communication and/or audio/video services to open space areas, or directly to workstations.

Resource RFB Series Floor Boxes are available in two- to six-gang models with a variety of aesthetic cover options including colors and profiles available.

Resource RFB Series Floor Boxes have many applications, including schools, financial institutions, commercial office buildings, hospitality and residences.

PRODUCTS: RFB2, RFB2-SS, RFB2-OG, RFB4, RFB4-SS, RFB4-4DB, RFB4-CI-1, RFB4-CI-NA, RFB6, RFB6-OG

Features & Benefits

- **RFB6 has independent wiring compartments that allow capacity for up to six duplex receptacles and/or communication services.** Reduces overall cost by providing for most cabling requirements.
- **The RFB4 has three versions for various applications.** A cast iron version to meet on grade requirements, a steel version to reduce installation cost on above grade floors, and a shallow steel version that provides flexibility with varying concrete depths.
- **Fully adjustable before and after the concrete pour.** Labor savings by adapting to various pour depths and conditions.
- **Range of conduit sizes.** Allows for most conduit schemes, even feed through capability, which saves time and money during installation. KOs range from 1/2" to 2" trade size.
- **Triple service boxes.** Accommodate power, communication and/or audio/video devices which reduces the need for multiple boxes.
- **Installs in both concrete and wood floors.** Provides the first recessed wood floor box for both commercial and residential applications.
- **RFB2-SS & RFB4-SS design allows for pass-around tunneling.** Flexible design of shallow floor boxes allows adjacent compartments to be wired together.
- **FloorPort Activation Covers.** Provides TopGuard protection from water, dirt and debris plus added strength and durability. Available in brushed aluminum and five decorative powder coat finishes: Black, Brass, Nickel, Gray and Bronze.
- **Wide variety of mounting brackets.** Can adapt to most power and communication needs. Reduces overall life cycle cost.
- **2" Conduit Hub.** By using 2HUB with the RFB6 Series Floor Box (sold separately) a greater capacity of pre-terminated cables can be brought in the a shallower box. Increasing the functionality and reducing concrete pours.
- **Lightweight "slab-on-grade" version.** Special fusion-bonded epoxy corrosion resistant paint finish allows for slab-on-grade use without the weight of cast iron material.
- **Datacom connectivity options.** Accepts industry standard and proprietary devices from a wide range of manufacturers to provide a seamless and aesthetically pleasing interface for voice, data, and A/V applications at the point-of-use. A wide selection of data and adapter options are available for use with Ortronics® TracJack and Series II devices.
- **Buy America Act/NAFTA versions.** FloorPort Service Fittings are available in versions that meet the Buy America Act/NAFTA requirements.

Vertical Markets

- Commercial
- Education
- Entertainment
- Healthcare
- Retail



Download this product's PEP ecopassport environmental product declaration at www.legrand.us/resources-and-downloads. This declaration conforms with ISO 14025 and 14040 and is in alignment with EN 15804.

Compliance

cULus Listed Metallic Outlet Boxes for tile, terrazzo, carpet and wood floors. File E2961 Guide QCIT



Protection from water, dirt, and debris.

Resource RFB® Series Floor Boxes with Rectangular Activations Selection Guide

Box Model	Install Floor Type:		Box Type:	Box Capacity:	Depth Behind Plates:	A/V Compatibility	Trade Size Conduit Feed:	Cover Style	Country of Origin	Adjustability
	Concrete	Wood								
RFB2	Yes	Yes	Above Grade	2 Gangs	3" [76mm]	Legrand AVIP, Altinex Intera, Extron AAP, MAAP & Decorator, Ortronics Series II	1/2" – 1 1/4"	FloorPort	Mexico	Fully Adjustable
RFB2-SS	Yes	Yes	Above Grade	2 Gangs	3" [76mm]		1/2" – 3/4"	FloorPort	Mexico	
RFB2-OG	Yes	Yes	On-Grade	2 Gangs	3" [76mm]		1/2" – 1 1/4"	FloorPort	Mexico	
RFB4	Yes	No	Above Grade	4 Gangs	2" [51mm]		1/2" – 1 1/4"	FloorPort	Mexico	
RFB4-4DB	Yes	No	Above Grade	4 Gangs	2" [51mm]		1/2" – 1 1/4"	FloorPort	Mexico	
RFB4-SS	Yes	No	Above Grade	4 Gangs	2" [51mm]		1/2" – 1"	FloorPort	Mexico	
RFB4-CI-1	Yes	No	On-Grade	4 Gangs	2" [51mm]		1" – 1 1/4"	FloorPort	China	
RFB4-CI-NA	Yes	No	On-Grade	4 Gangs	2" [51mm]		1" – 1 1/4"	FloorPort	USA	
RFB6	Yes	Yes	Above Grade	6 Gangs	3 1/4" [83mm]		3/4" – 2"	FloorPort	Mexico	
RFB6-OG	Yes	Yes	On-Grade	6 Gangs	3 1/4" [83mm]		3/4" – 2"	FloorPort	Mexico	

NOTE: Pricing may vary depending on country of origin. Consult your local sales representative for more information.

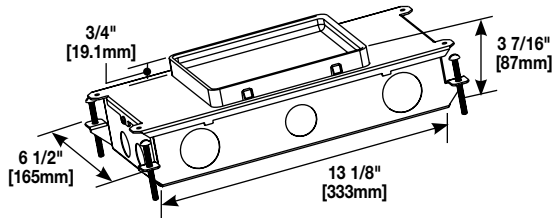
RFB2 Series Floor Boxes Ordering Information
RFB2-OG

Two-Compartment Box – For use On Grade. Fully adjustable with tunnel compartment. Supplied with one (1) duplex receptacle mounting plate, and one (1) communication mounting plate (RFB22AB). Other device plates sold separately.

NOTE: RFB2-OG for on-grade applications is painted with a fusion-bonded epoxy designed for use on metal reinforcement bar and related accessories before encapsulating in concrete.

Country of Origin: Mexico

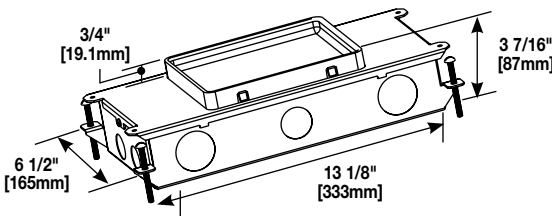
RFB2

Two-Compartment Box – For use in either concrete or wood floors. Fully adjustable with tunnel compartment. Supplied with one (1) duplex receptacle mounting plate, and one (1) communication mounting plate (RFB22AB). Other device plates sold separately.

Country of Origin: Mexico

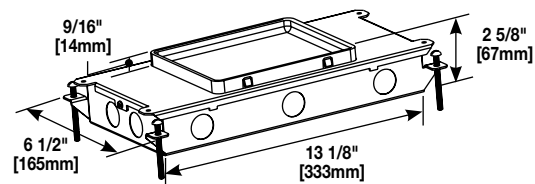
RFB2-SS

Two-Compartment Shallow Stamped Steel Floor Box – For use in either concrete or wood floors. Fully adjustable with tunnel compartment. Supplied with one (1) duplex receptacle mounting plate, and one (1) communication mounting plate (RFB22AB). Other device plates sold separately.

Country of Origin: Mexico

RFB2 Series Floor Boxes Compartment Capacities/Knockout Locations & Sizes

RFB2 & RFB2-OG

Power or Data
50.2 cu. in. [822.6 ml]
Each Side

Top View

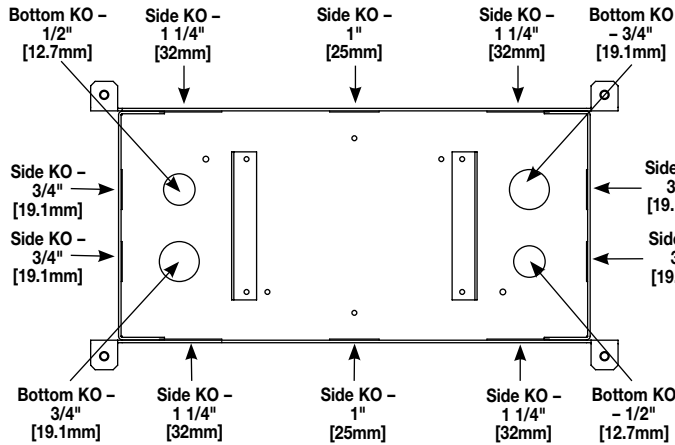

RFB2-SS

Power or Data
38.0 cu. in. [622.7 ml]
Each Side

Top View

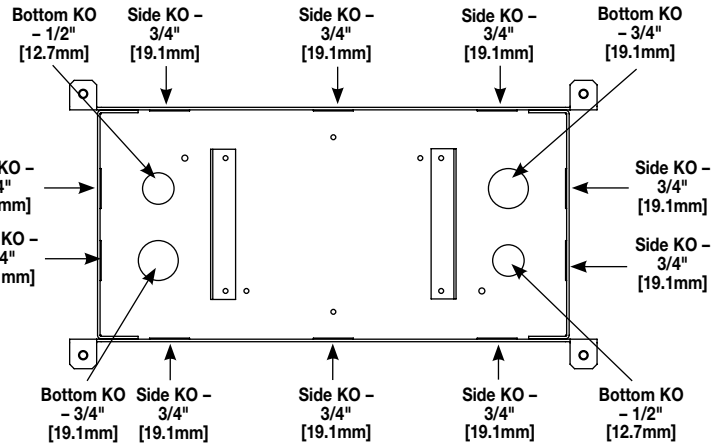

RFB2 Series Floor Box Accessories Ordering Information

RFB2DP

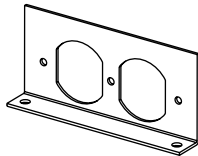

Internal Duplex Receptacle Bracket – Accepts standard 15 Amp & 20 Amp Duplex Receptacles.

Country of Origin: Mexico

RFB2RT

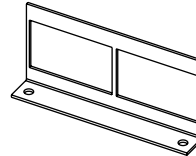

Internal Communication Bracket – Includes Two (2) adapters to accept Ortronics® TracJack devices, and Two (2) adapters to accept Ortronics® Series II devices. (sold separately)

Country of Origin: Mexico

RFB2B



Internal Blank Bracket – Plate used to close off unused gangs.

Country of Origin: Mexico

RFB2EXT

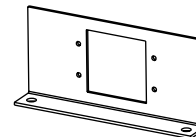

Internal Audio/Video Bracket – Accepts two (2) Legrand AVIP or Extron® Electronics MAAP Series devices. (sold separately)

Country of Origin: Mexico

RFB2GFI

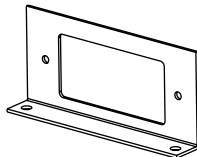

Internal GFI or Decorator Style Receptacle Bracket – Accepts standard GFCI or Decorator Style Receptacles, Communication or A/V Devices.

Country of Origin: Mexico

RFB2-AAP

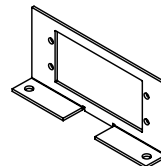

Internal Audio/Video Bracket – Accepts Two (2) Extron® Electronics AAP Series devices. (sold separately)

Country of Origin: Mexico

RFB22AB

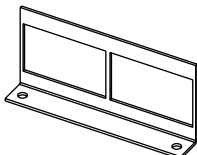

Internal Communication Bracket – Includes two (2) adapters to accept Wiremold CM2 Series Open System communication inserts. (sold separately)

Country of Origin: Mexico

RFB2 Series Floor Box Accessories Ordering Information

RFBKIT

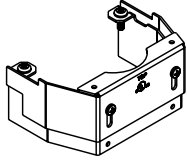

Barrier Kit – Barrier kit used to separate power and communication wires in partition feed covers. Supplied with base and three extensions to adjust to cover height. Kit should be used on RFB2, RFB2-OG, RFB2-SS, RFB4 and RFB4-SS Floor Boxes. Kits are sold separately.

Country of Origin: USA

FP-CTR

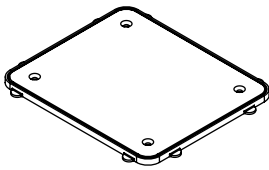

Bare Concrete & Terrazzo Ring – Nonmetallic ring for use on bare polished concrete and terrazzo floor applications.

Country of Origin: USA

PKER

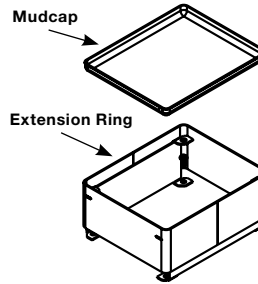

Extensions – Attaches to preset to add height to preset. Can be field installed.

Extension	Height Above Preset "A"
PKER-10	1" [25mm]
PKER-15	1 1/2" [38mm]
PKER-20	2" [51mm]
PKER-25	2 1/2" [64mm]
PKER-30	3" [76mm]

Country of Origin: USA

S3AXB

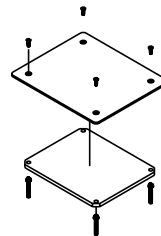

Blanking Plate – Aluminum top plate with steel support plate and four (4) adjusting screws.

Country of Origin: USA

RFB4 & RFB4-4DB Floor Box Ordering Information

RFB4

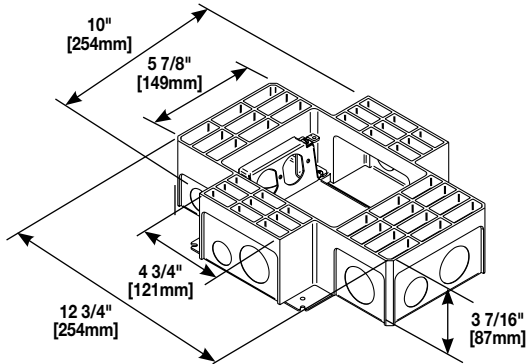

Four-Compartment Combination Box – 12 3/4" L x 10" W x 3 7/16" D [324mm x 254mm x 87mm]. Fully adjustable with tunnel compartment and two receptacle brackets. **Tunneling from end power compartment to end power compartment only.** Communication brackets not included. See "Accessories".

NOTE: Only for use in concrete floors.

Country of Origin: Assembled in Mexico from components made in the USA

RFB4-4DB

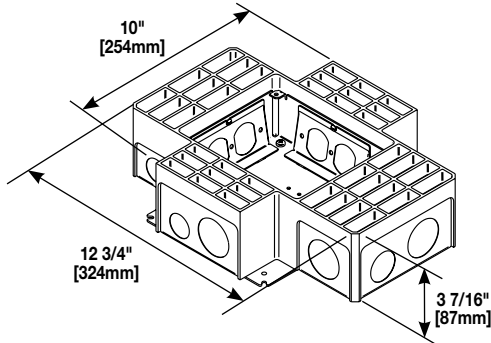

Four-Compartment Box – Includes four duplex receptacle brackets. 12 3/4" L x 10" W x 3 7/16" D [324mm x 254mm x 87mm]. Fully adjustable. **Tunneling from adjacent or opposite compartments only, (not cross compartments).** Tunneling can be set to feed all four compartments from one conduit in a single-service application.

NOTE: Only for use in concrete floors.

Country of Origin: Assembled in Mexico from components made in the USA

RFB4 & RFB4-4DB Floor Box Compartment Capacities and Knockout Locations and Sizes

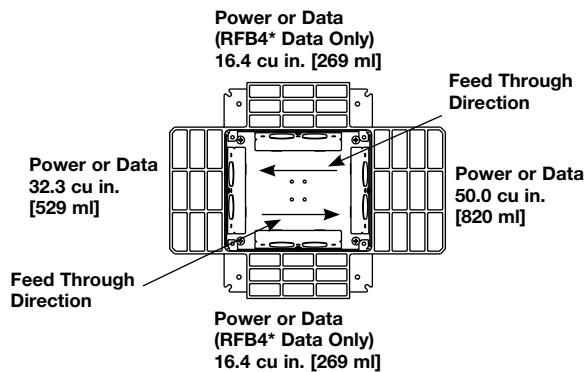

FOR RFB4

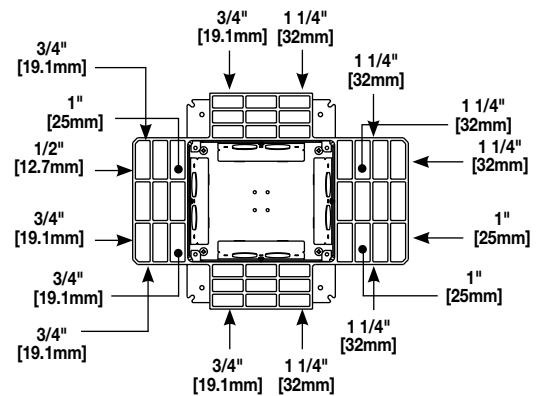

Indicates Bottom KO.

*No feed through to opposite data compartment on RFB4.

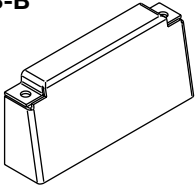
RFB4 & RFB4-4DB Floor Box Accessories Ordering Information
RFB-B

Internal Blank Bracket – Power compartments only. Used to close off unused gangs.

Country of Origin: USA

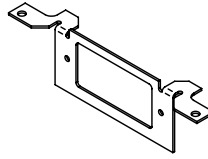
DTB-2-DECORA

Communication Bracket – Decorator style opening for decorator style 106 Adapter.

Country of Origin: Mexico

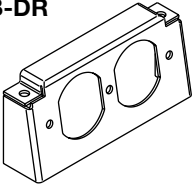
RFB-DR

Internal Duplex Bracket – Accepts standard 15 Amp & 20 Amp Duplex Receptacles.

Country of Origin: USA

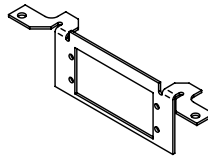
DTB-2-AAP

Internal Audio/Video Bracket – Accepts two (2) Extron® Electronics AAP devices (sold separately)

Country of Origin: Mexico

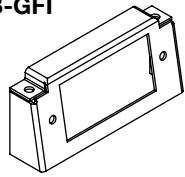
RFB-GFI

Internal GFI Bracket – Accepts standard GFCI or Decorator Style Receptacles, Communication or Audio/Video Devices.

Country of Origin: USA

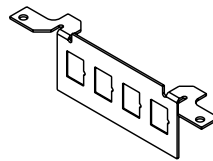
DTB-2-4TKO

Communication Bracket – Four (4) RJ keystone opening knockouts. Use as blank plate or for up to four (4) RJ openings.

NOTE: Opening dimension is 9/16" x 3/4" (14.3mm x 19.1mm).

Country of Origin: USA

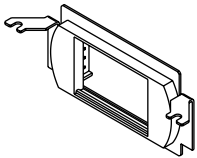
RFB4-LPB

Communication Bracket – Activate™ low profile adapter included. Wiremold CM Series Open System inserts sold separately.

Country of Origin: Mexico

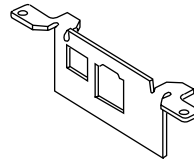
DTB-2-DT

Communication Bracket – With one IBM Type II opening and one keystone opening (devices not included).

NOTE: For RFB4 only.

Country of Origin: Mexico

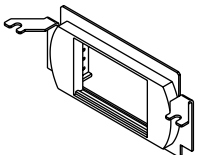
RFB4-LPBS2

Communication Bracket – Ortronics® Series II Low profile adapter included.

Country of Origin: Mexico

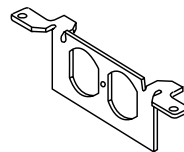
DTB-2-SD

Communication Bracket – With duplex opening for use with 106 Adapter (sold separately) (devices not included).

NOTE: For RFB4 only.

Country of Origin: Mexico

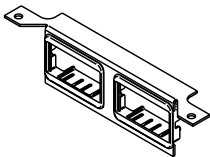
DTB-2-2AB

Communication Bracket – Two (2) 2A size adapters included. Wiremold CM2 Series Open System inserts, sold separately.

Country of Origin: Mexico

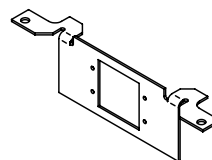
DTB-EXT

Internal Audio/Video Bracket – Accepts two (2) Legrand AVIP or Extron Electronics MAAP devices (sold separately).

NOTE: For RFB4 only.

Country of Origin: Mexico

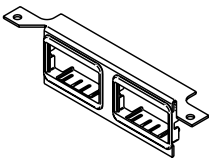
DTB-2-RT

Communication Bracket – Ortronics® AB2TJ TracJack and ABS2 Series II adapters included.

Country of Origin: Mexico

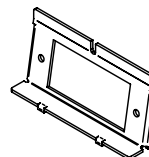
RFB-GFI-4DB

Internal GFI Bracket – Accepts standard GFCI or Decorator style receptacles, communications or A/V devices.

NOTE: For RFB4-4DB only.

Country of Origin: USA

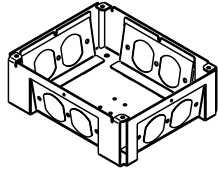
RFB4 & RFB4-4DB Floor Box Accessories Ordering Information
RFB-WTB

Conversion Kit – To convert the RFB4 Box to a RFB4-4DB Box.

NOTE: For RFB4 & RFB4-4DB.

Country of Origin: Mexico

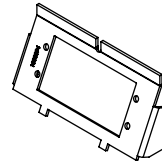
WTB-AAP

Internal Audio/Video Bracket – Accepts two (2) Extron Electronics AAP Series Devices (sold separately).

NOTE: For RFB4-4DB only.

Country of Origin: USA

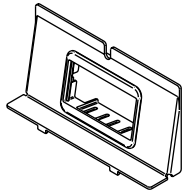
WTB-2-AB

Communication Bracket – One 2A adapter included. Wiremold CM2 Series Open System inserts sold separately.

NOTE: For RFB4-4DB only.

Country of Origin: Mexico

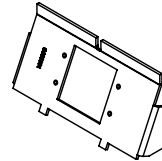
WTB-MAAP

Internal Audio/Video Bracket – Accepts two (2) Legrand AVIP or Extron® Electronics MAAP Series Devices (sold separately).

NOTE: For RFB4-4DB only.

Country of Origin: USA

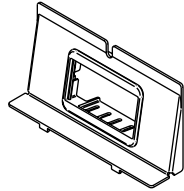
WTB-2-RT

Communication Bracket – Ortronics® AB2TJ TracJack and ABS2 Series II adapters included.

NOTE: For RFB4-4DB only.

Country of Origin: Mexico

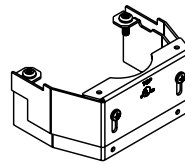
RFBKIT

Barrier Kit – Barrier kit used to separate power and communication wires in partition feed covers. Supplied with base and three extensions to adjust to cover height. Kit should be used on RFB2, RFB2-OG, RFB2-SS, RFB4 and RFB4-SS Floor Boxes. Kits are sold separately.

Country of Origin: USA

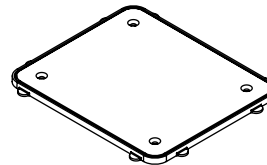
FP-CTR

Bare Concrete & Terrazzo Ring – Nonmetallic ring for use on bare polished concrete and terrazzo floor applications.

Country of Origin: USA

RFB4-CI-1 & RFB4-CI-NA Floor Box Ordering Information

RFB4-CI-1

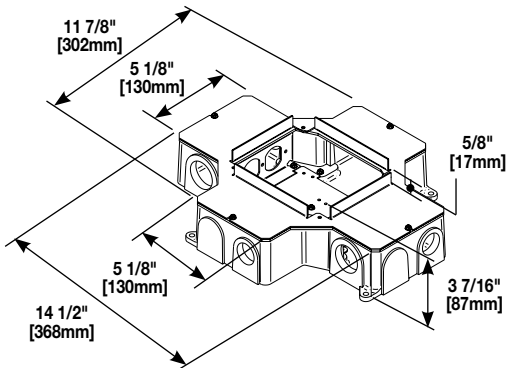

Four-Compartment Cast Iron Box – 14 1/2" L x 11 7/8" W x 3 7/16" D [368mm x 302mm x 87mm]. Fully adjustable with tunnel compartment and two receptacle brackets. **Feed through from adjacent or opposite compartments only, (not cross compartments).** Communication brackets not included. See "Accessories".

NOTE: Only for use in concrete floors.
All boxes and activations are sold separately.

Country of Origin: China

RFB4-CI-NA

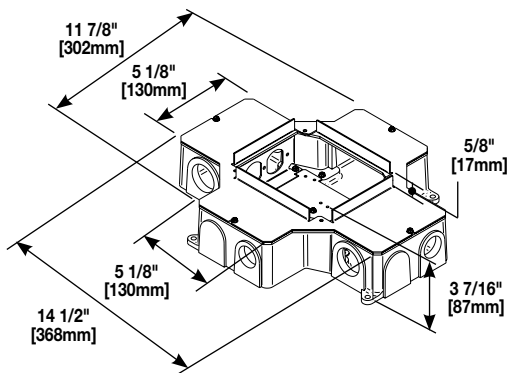

Four-Compartment Cast Iron Box – 14 1/2" L x 11 7/8" W x 3 7/16" D [368mm x 302mm x 87mm]. Fully adjustable with tunnel compartment and two receptacle brackets. **Feed through from adjacent or opposite compartments only, (not cross compartments).** Communication brackets not included. See "Accessories".

NOTE: Only for use in concrete floors.
All boxes and activations are sold separately.

Country of Origin: USA

RFB4-CI-1 & RFB4-CI-NA Floor Box Compartment Capacities and Knockout Locations and Sizes

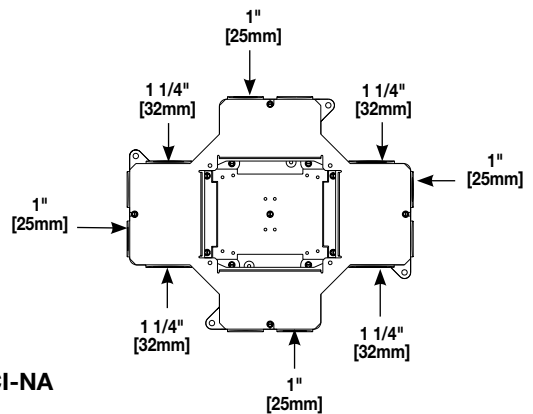
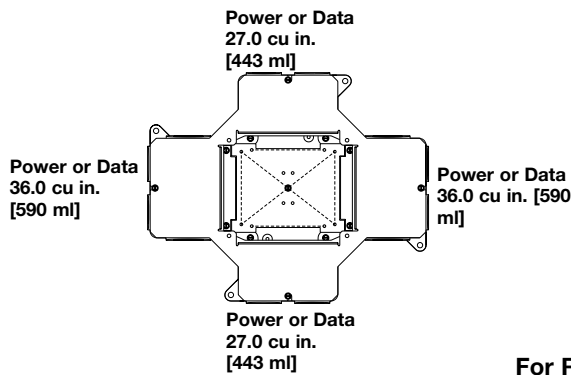

For RFB4-CI-1 & RFB4-CI-NA

NOTE: Pricing varies depending on country of origin. Consult your local sales representative for more information.

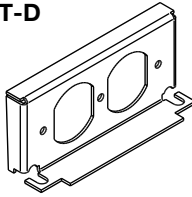
RFB4-CI-1 & RFB4-CI-NA Floor Box Accessories Ordering Information
CIHT-D

Internal Duplex Receptacle Bracket – Accepts standard 15 Amp & 20 Amp Duplex Receptacles.

Country of Origin: USA

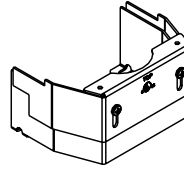
RFB4CIKIT

Barrier Kit – Barrier kit used with RFB4-CI Floor Boxes. Kits are sold separately.

Country of Origin: USA

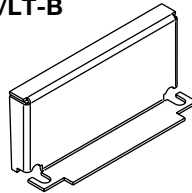
CIH/LT-B

Internal Blank Bracket – Used to close off unused gangs.

Country of Origin: USA

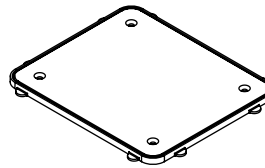
FP-CTR

Bare Concrete & Terrazzo Ring – Nonmetallic ring for use on bare polished concrete and terrazzo floor applications.

Country of Origin: USA

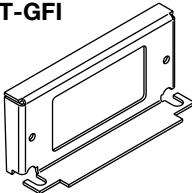
CIHT-GFI

Internal GFI Device Bracket – Accepts standard GFCI or Decorator Style Receptacles, Communication or Audio/Video Devices.

Country of Origin: USA

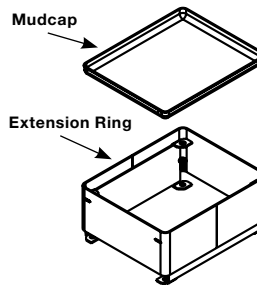
PKER

Extensions – Attaches to preset to add height to preset. Can be field installed.

Extension	Height Above Preset "A"
PKER-10	1" [25mm]
PKER-15	1 1/2" [38mm]
PKER-20	2" [51mm]
PKER-25	2 1/2" [64mm]
PKER-30	3" [76mm]

Country of Origin: USA

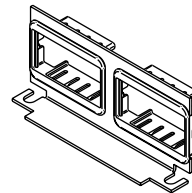
CILT-2AB

Communication Bracket – Communication bracket with two 2A size Activate adapters included. Accepts Wiremold CM2 Series Open System communication modules (sold separately).

Country of Origin: Mexico

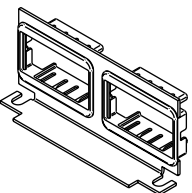
CILT-2-RT

Communication Bracket – Communication bracket with Ortronics AB2TJ TracJack and ABS2 Series II adapters included. Accepts Ortronics workstation connectivity outlets and modular inserts.

Country of Origin: Mexico

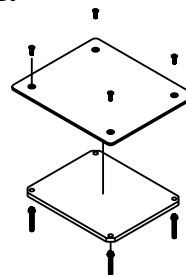
S3AXB

Blanking Plate – Aluminum top plate with steel support plate and four (4) adjusting screws.

Country of Origin: USA

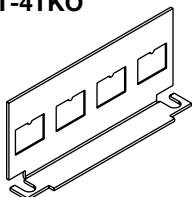
CILT-4TKO

Communication Bracket – Communication bracket with four (4) RJ opening knockouts. Use as blank plate or for up to four RJ openings.

NOTE: Opening dimension is 9/16" x 3/4" [14.3mm x 19.1mm].

Country of Origin: USA

RFB4-SS Floor Box Ordering Information

RFB4-SS

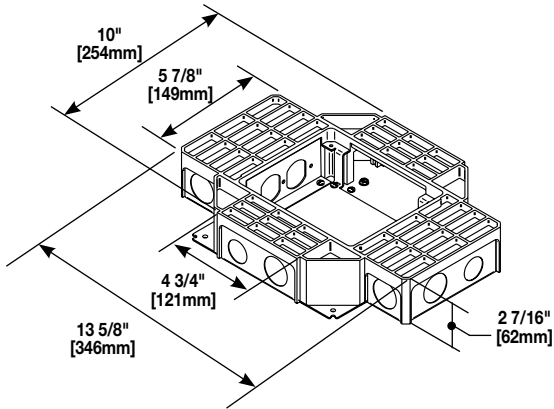

Four-Compartment Shallow Stamped Steel Box – 13 5/8" L x 10" W x 2 7/16" D [346mm x 254mm x 62mm]. Fully adjustable with tunnel compartment and two receptacle brackets.
Feed through tunneling to adjacent compartments only.
 Tunneling can be set to feed all four compartments from one conduit in a single-service application. Communication brackets not included. See "Accessories".

NOTE: Only for use in concrete floors.
 All boxes and activations are sold separately.

Country of Origin: Assembled in Mexico from components made in the USA

RFB4-SS Floor Box Compartment Capacities and Knockout Locations and Sizes

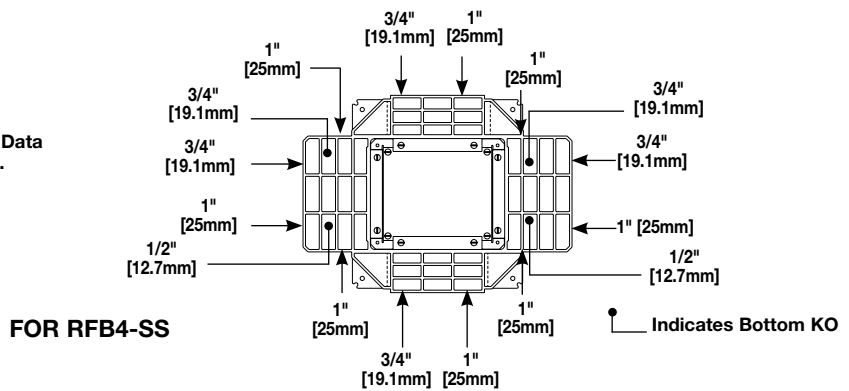
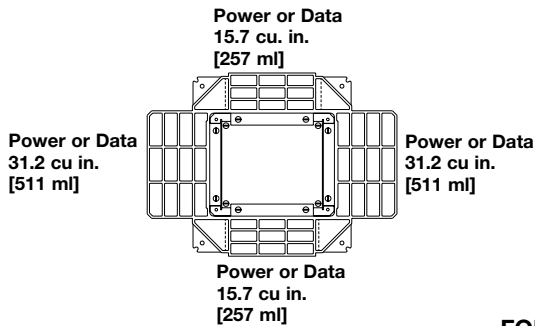

RFB4-SS Floor Box Accessories Ordering Information

RFB-B-SS

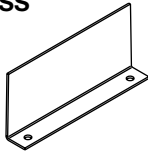

Internal Blank Bracket – Used to close off unused gangs.

Country of Origin: Mexico

RFB-RB-SS

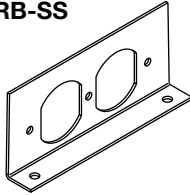

Internal Duplex Receptacle Bracket – Accepts standard 15 Amp & 20 Amp Duplex Receptacles.

Country of Origin: Mexico

RFB-GFI-SS

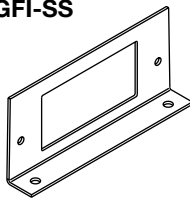

Internal GFI Receptacle Bracket – Accepts standard GFCI & Decorator style Receptacles Communication or Audio/Video Devices.

Country of Origin: Mexico

RFB-2AB-SS

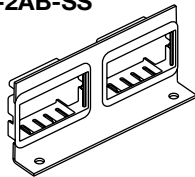

Internal Bracket – Two Pass & Seymour Activate adapters included. Wiremold CM Series Open System inserts sold separately.

Country of Origin: Mexico

RFB-2-SSRT

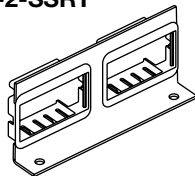

Communication Bracket – Ortronics® AB2TJ TracJack and ABS2 Series II adapters included.

Country of Origin: Mexico

RFB-4TKO-SS

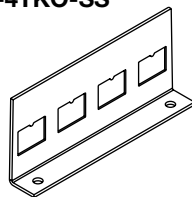

Internal Bracket – Four RJ Keystone opening knockouts. Use as blank plate or for up to four RJ openings.

NOTE: Opening dimension is 9/16" x 3/4"
[14.3mm x 19.1mm].

Country of Origin: Mexico

RFB4-SS-AAP

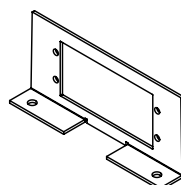

Internal Audio/Video Bracket – Accepts two (2) Extron Electronics AAP Series Devices. (Sold separately)

Country of Origin: Mexico

RFB4-SS-MAAP

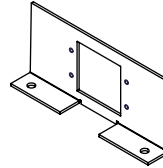

Internal Audio/Video Bracket – Accepts two Extron® Electronics MAAP Series Devices. (Sold separately)

Country of Origin: Mexico

RFBKIT

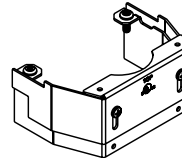

Barrier Kit – Barrier kit used to separate power and communication wires in partition feed covers. Supplied with base and three extensions to adjust to cover height. Kit should be used on RFB2, RFB2-OG, RFB2-SS, RFB4 and RFB4-SS Floor Boxes. Kits are sold separately.

Country of Origin: USA

FP-CTR

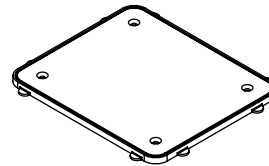

Bare Concrete & Terrazzo Ring – Nonmetallic ring for use on bare polished concrete and terrazzo floor applications.

Country of Origin: USA

PKER

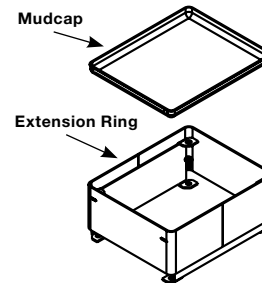

Extensions – Attaches to preset to add height to preset. Can be field installed.

Extension	Height Above Preset "A"
PKER-10	1" [25mm]
PKER-15	1 1/2" [38mm]
PKER-20	2" [51mm]
PKER-25	2 1/2" [64mm]
PKER-30	3" [76mm]

Country of Origin: USA

S3AXBP

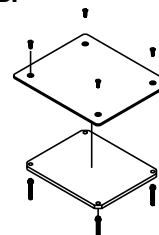

Blanking Plate – Aluminum top plate with steel support plate and four (4) adjusting screws.

Country of Origin: USA

RFB6 Series Floor Box Ordering Information

RFB6

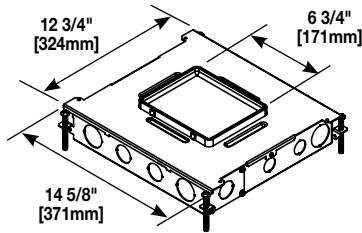

Six-Compartment Box – For use in either concrete or wood floors. Fully adjustable with tunnel compartment. Supplied with two (2) duplex mounting plates, two (2) communication mounting plates (RFB62A), and (2) blank mounting plates. Other plates sold separately.

Country of Origin: Mexico

RFB6-OG

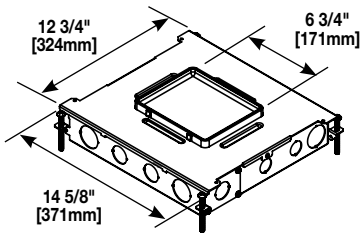

Six-Compartment On-Grade Box – For use in either concrete or wood floors. Fully adjustable with tunnel compartment. Supplied with two (2) duplex mounting plates, two (2) communication mounting plates (RFB62A), and (2) blank mounting plates. Other plates sold separately.

Country of Origin: Mexico

RFB6 Series Floor Box Compartment Capacities and Knockout Locations and Sizes

COMPARTMENT CAPACITIES

A = Power or Data 52 in² [852ml]

B = Power or Data 23 in² [376ml]

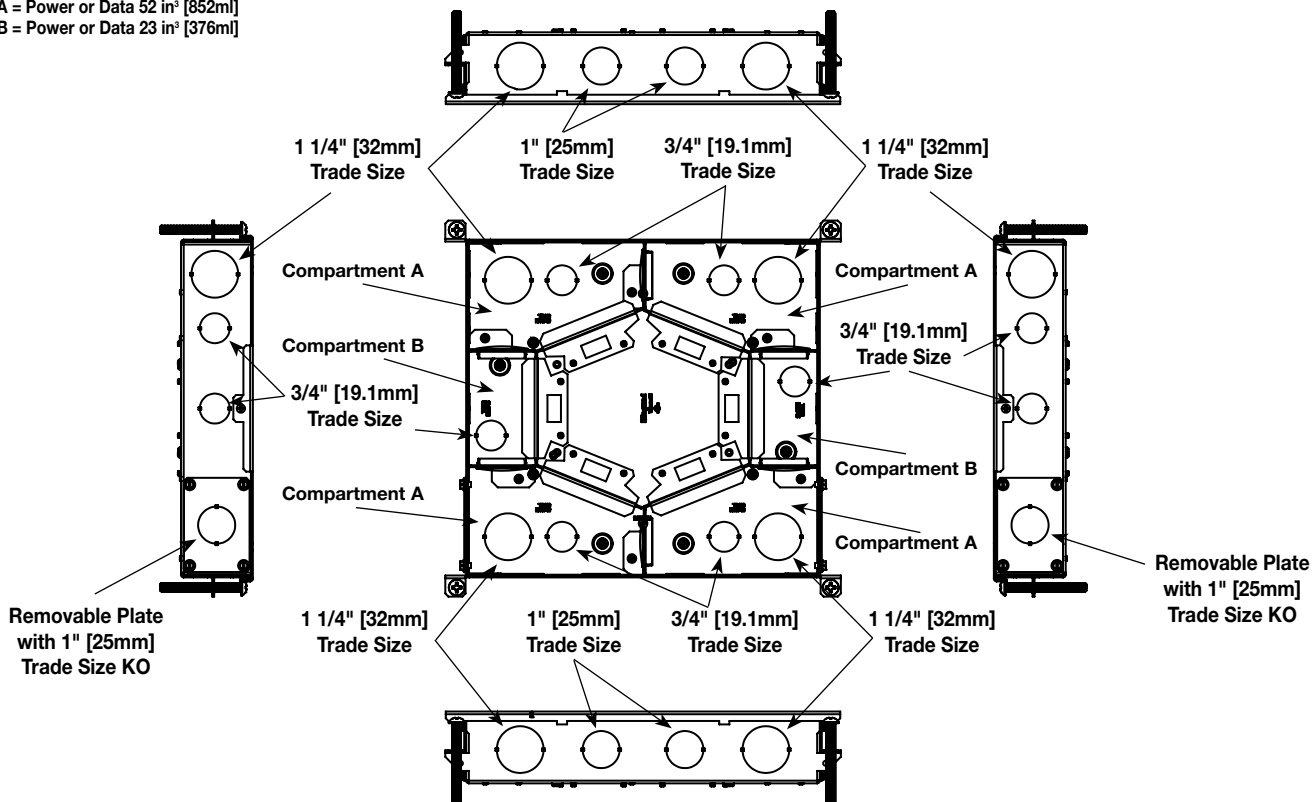

Feed through is accomplished through removable plugs.
2-inch HUB feed through accomplished by removing divider.

RFB6 Series Floor Box Accessories Ordering Information

RFB6DP

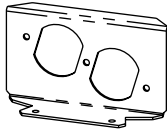

Internal Duplex Receptacle Bracket – Accepts standard 15 & 20 Amp Duplex Receptacles.

Country of Origin: USA

RFB6B

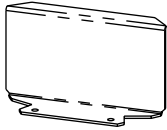

Internal Blank Bracket – Closes off unused gangs.

Country of Origin: USA

RFB6-GFI

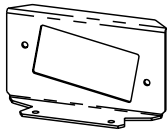

Internal GFI or Decorator Style Receptacle Bracket – Accepts standard GFCI & Decorator Style Receptacles, Communication or A/V Devices.

Country of Origin: USA

RFB6S1

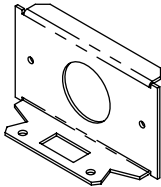

Internal Single Receptacle Bracket – Receptacle opening 1 3/8" (35mm).

Country of Origin: USA

RFB6S2

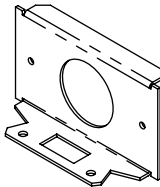

Internal Single Receptacle Bracket – Receptacle opening 1 9/16" (40mm).

Country of Origin: USA

RFB6RT

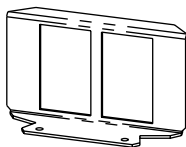

Internal Communication Bracket – Includes one (1) adapter to accept Ortronics TracJack devices, and one (1) adapter to accept Ortronics Series II devices (sold separately).

Country of Origin: USA

RFB6EXT

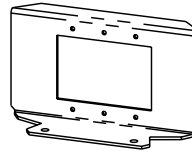

Internal Audio/Video Bracket – Accepts three (3) Legrand AVIP or Extron Electronics MAAP Series devices (sold separately).

Country of Origin: USA

RFB62A

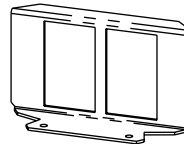

Internal Communication Bracket – Includes two (2) adapters to accept Wiremold CM2 Series Open System communication inserts (sold separately).

Country of Origin: USA

RFB6-AAP

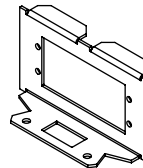

Internal A/V Bracket – Accepts two (2) Extron Electronics AAP Series Devices (sold separately).

Country of Origin: USA

FP-CTR

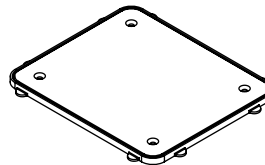

Bare Concrete & Terrazzo Ring – Nonmetallic ring for use on bare polished concrete and terrazzo floor applications.

Country of Origin: USA

PKER

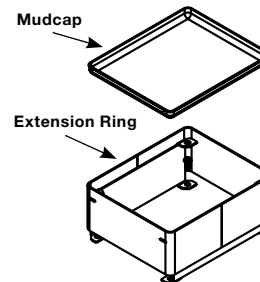

Extensions – Attaches to preset to add height to preset. Can be field installed.

Extension	Height Above Preset "A"
PKER-10	1" [25mm]
PKER-15	1 1/2" [38mm]
PKER-20	2" [51mm]
PKER-25	2 1/2" [64mm]
PKER-30	3" [76mm]

Country of Origin: USA

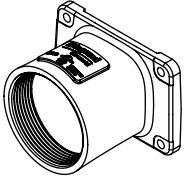
RFB6 Series Floor Box Accessories Ordering Information**2HUB**

2" Conduit Transition Fitting – Trade size 2" die cast zinc conduit fitting allows for 2" conduit to transition into a shallow box design. Includes: die cast fitting gasket. Accepts standard 2" threaded conduit or trade size EMT and PVC conduit fittings.

Country of Origin: USA

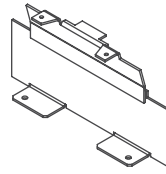
RFB6KIT

Barrier Kit – Used to separate power and communication services. Used in combination with FloorPort Furniture Feed Covers (FPFFTC Series). Covers sold separately.

Country of Origin: USA

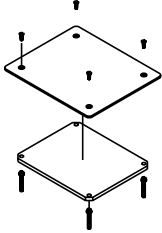
S3AXBP

Blanking Plate – Aluminum top plate with steel support plate and four (4) adjusting screws.

Country of Origin: USA

FloorPort Series Cover Assemblies for Resource RFB® Series Floor Boxes

FLOORPORT PART NUMBER CONFIGURATOR								
FP	B		TC		NK			
FloorPort Cover	Blank Top	B	Tile (Flangeless)	T	Nickel	NK	Bronze	BZ
	Cutout Top	C	Tile/Carpet (Flanged)	TC	Brass	BS	Gray	GY
	Furniture Feed	FF			Black	BK	Brushed Aluminum	AL

FloorPort Series Flanged Cover Assemblies Ordering Information

FPCTCBK
FPCTCBZ
FPCTCBS
FPCTCNK
FPCTCAL
FPCTCGY

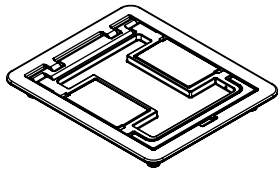

Cutout Cover Assembly –
 Flanged cover for use in tile or carpet installation. Die-cast aluminum assembly available in black (BK), bronze (BZ), brass (BS), nickel (NK), gray (GY), or brushed aluminum (AL). Insert in lid allows for carpet or tile cutouts to match finished floor.

Country of Origin: India

FPFFTCBK
FPFFTCBZ
FPFFTCBS
FPFFTCNK
FPFFTCAL
FPFFTCGY

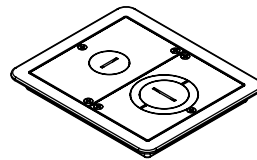

Furniture Feed Cover Assembly –
 Flanged cover for use in tile or carpet installation. Die-cast aluminum assembly available in black (BK), bronze (BZ), brass (BS), nickel (NK), gray (GY), or brushed aluminum (AL). Provided with one 1" trade size screw plug for power or communication type cabling and one combination 1 1/4" and 2" trade size screw plug for communication type cabling. Allows for feeding both power and communication cabling.

Country of Origin: China

FPBTCBK
FPBTCBZ
FPBTCBS
FPBTCNK
FPBTCAL
FPBTCGY

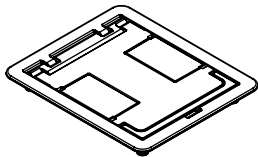

Blank Cover Assembly –
 Flanged cover for use in tile or carpet installation. Die-cast aluminum assembly available in black (BK), bronze (BZ), brass (BS), nickel (NK), gray (GY), or brushed aluminum (AL). Lid area is flush with the finished floor, no cutouts provided.

Country of Origin: India

FloorPort Series Flangeless Cover Assemblies Ordering Information

FPCTBK
FPCTBZ
FPCTBS
FPCTNK
FPCTAL
FPCTGY

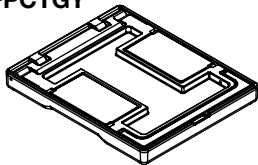

Cutout Cover Assembly –
 Flangeless cover for use in tile installations. Die-cast aluminum assembly available in black (BK), bronze (BZ), brass (BS), nickel (NK), gray (GY), or brushed aluminum (AL). Insert in lid allows for tile cutouts to match finished floor.

Country of Origin: India

FPFFTBK
FPFFTBZ
FPFFTBS
FPFFTNK
FPFFTAL
FPFFTGY

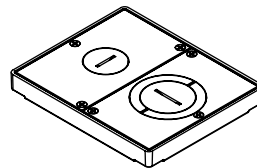

Furniture Feed Cover Assembly –
 Flangeless cover for use in tile installations. Die-cast aluminum assembly available in black (BK), bronze (BZ), brass (BS), nickel (NK), gray (GY), or brushed aluminum (AL). Provided with one 1" trade size screw plug for power or communication type cabling and one combination 1 1/4" and 2" trade size screw plug for communication type cabling. Allows for feeding both power and communication cabling.

Country of Origin: China

FPBTBK
FPBTBZ
FPBTBS
FPBTNK
FPBTAL
FPBTGY

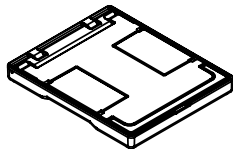

Blank Cover Assembly –
 Flangeless cover for use in tile installations. Die-cast aluminum assembly available in black (BK), bronze (BZ), brass (BS), nickel (NK), gray (GY), or brushed aluminum (AL). Lid area is flush with the finished floor, no cutouts provided.

Country of Origin: India

NOTE: Pricing varies depending on country of origin. Consult your local sales representative for more information.

North America Made FloorPort Series Cover Assemblies for Resouce RFB® Series Floor Boxes

FLOORPORT PART NUMBER CONFIGURATOR										
FP	B		TC		NK			NA		
FloorPort Cover	Blank Top	B	Tile (Flangeless)	T	Nickel	NK	Bronze	BZ	North America Made	NA
	Cutout Top	C	Tile/Carpet (Flanged)	TC	Brass	BS	Gray	GY		
	Furniture Feed	FF			Black	BK	Brushed Aluminum	AL		

North America Made FloorPort Series Flanged Cover Assemblies Ordering Information

FPCTCBK-NA
FPCTCBZ-NA
FPCTCBS-NA
FPCTCNK-NA
FPCTCGY-NA

Cutout Cover Assembly –
Flanged cover for use in tile or carpet installation. Die-cast aluminum assembly available in black (BK), bronze (BZ), brass (BS), nickel (NK) or gray (GY). Insert in lid allows for carpet or tile cutouts to match finished floor.

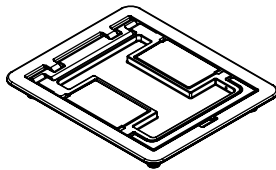

Country of Origin: USA

FPBTCBK-NA
FPBTCBZ-NA
FPBTCBS-NA
FPBTCNK-NA
FPBTCGY-NA

Blank Cover Assembly –
Flanged cover for use in tile or carpet installation. Die-cast aluminum assembly available in black (BK), bronze (BZ), brass (BS), nickel (NK) or gray (GY). Lid area is flush with the finished floor, no cutouts provided.

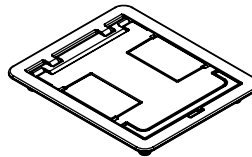

Country of Origin: USA

NOTE: Pricing varies depending on country of origin. Consult your local sales representative for more information.

LOAD CAPACITIES FOR FLOORPORT COVER ASSEMBLIES	
CATALOG NUMBERS	MAXIMUM LOAD IN POUNDS
FPCTC	1000
FPBTC	750
FPFFTC	1000
FPCT	1000
FPBT	750
FPFFT	1000

NOTE: Load applied through a 2" [51mm] mandrel in center of service fitting. Loads above are static loads only and do not pertain to rolling loads.

NOTE: All brand and product names referenced in this document are registered trademarks or trademarks of their respective holders.

NOTE: The paper used to print this document is an environmentally responsible paper with 10% post consumer waste, with FSC and SFI Chain of Custody certifications, Lacey Act complaint. 100% of the electricity used to manufacture Flo sheets is generated with Green-e certified renewable energy.



Legrand, North America
60 Woodlawn Street
West Hartford, CT 06110
1.877.BY.LEGRAND (295.3472)
www.legrand.us

Canada
905.738.9195
www.legrand.ca

FOLLOW US

