

Project		Catalog #		Type	
Prepared by		Notes		Date	



HALO

RL4-DM

4" All-Purpose LED Retrofit Direct Mount w/ Remote Driver/Junction Box
600 Lumen Series

Typical Applications

Residential

Interactive Menu

- Order Information [page 2](#)
- Product Specifications [page 3](#)
- Photometric Data [page 4](#)
- Energy & Performance Data [page 4](#)
- Product Warranty

Product Certification



Refer to ENERGY STAR® Certified Products List.
Can be used to comply with California Title 24 High Efficacy requirements.
Certified to California Appliance Efficiency Database under JAB.

Product Features



Top Product Features

- 4" Direct Mount Field Selectable CCT LED Retrofit
- Direct mount - does not require recessed housing or junction box
- Select from 5 CCTs via switch; 2700K, 3000K, 3500K, 4000K, 5000K CCT
- Wet location listed for showers and protected ceilings
- Dimmable to 5% with 120V dimmers

Dimensional and Mounting Details

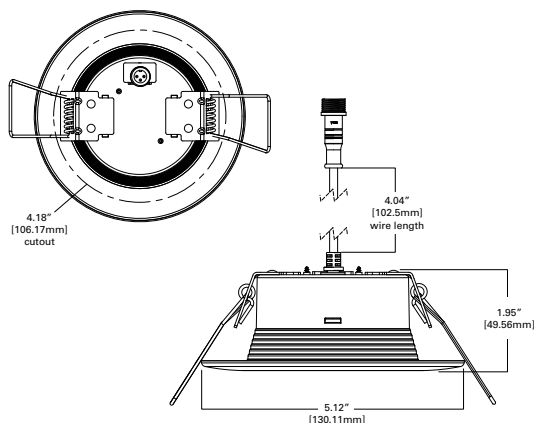

Scale

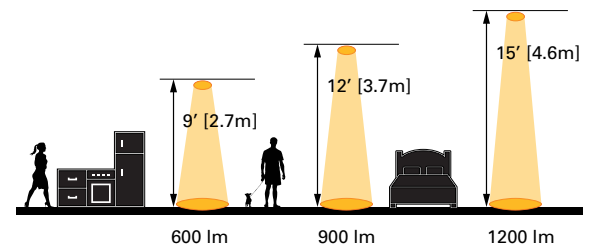

Order Information

SAMPLE ORDER NUMBER: **RL4069S1EWHDMR**

A complete luminaire consists of an LED module and remote driver/junction box.

Models	Lumens	CRI/CCT	Driver	Finish	Mounting	Packaging
Models	Lumens	CRI/CCT	Driver	Finish	Mounting	Packaging
RL4 = 4" All-Purpose Retrofit LED module	06 = 600 lumens (nominal)	9S = 90 CRI minimum, white tuning, selectable CCT 2700K-5000K	1E = 120V 60Hz leading or trailing edge phase cut 5% dimming	WH = Matte white baffle	DM = Direct Mount	R = recyclable 4-color unit carton suitable for point of purchase merchandising display
Notes	Notes	Notes	Notes	Notes	Notes	Notes

Accessories

Accessories	
<p>Mounting Frame HL4NCMF = 4" new construction mounting frame HL4RSMF = 4" round and square mounting frame</p> <p>Designer Trims RL4TRMWHB = 4" decorative overlay, white paintable, Baffle RL4TRMMBB = 4" decorative overlay, matte black, Baffle RL4TRMSNB = 4" decorative overlay, satin nickel, Baffle RL4TRMTBZB = 4" decorative overlay, tuscan bronze, Baffle</p> <p>RL4TRMWH = 4" decorative overlay, white paintable, smooth splay RL4TRMMB = 4" decorative overlay, matte black, smooth splay RL4TRMSN = 4" decorative overlay, satin nickel, smooth splay RL4TRMTBZ = 4" decorative overlay, tuscan bronze, smooth splay</p>	<p>Extension Cable Dedicated Driver/Jbox HLB06EC - 6 ft. extension cable HLB12EC - 12 ft. extension cable HLB20EC - 20 ft. extension cable</p> <p>Extension Cable seleCCTable Driver/Jbox HLB06FSEC - 6 ft. extension cable HLB12FSEC - 12 ft. extension cable HLB20FSEC - 20 ft. extension cable</p>



RL4TRMWHB
White (Paintable), Baffle

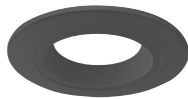

RL4TRMMBB
Matte Black, Baffle

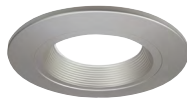

RL4TRMSNB
Satin Nickel, Baffle

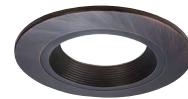

RL4TRMTBZB
Tuscan Bronze, Baffle



RL4TRMWH
White (Paintable), Splay



RL4TRMWB
Matte Black, Splay



RL4TRMSN
Satin Nickel, Splay



RL4TRMTBZ
Tuscan Bronze, Splay

Product Specifications

CCT Select System

- SeleCCTable models use the switch to choose between 2700K, 3000K, 3500K, 4000K, and 5000K CCT.

Module - Trim

- Module construction includes LED Array, heat sink, reflector, lens, baffle and trim ring.
- Regressed baffle
- Heat sink designed to conduct heat away from the LED Array

LED Array

- Mid power LED array provides a uniform source with high efficiency and no pixilation.
- 90 CRI minimum, R9 greater than 50
- Color accuracy within 3 SDCM at the CCT endpoints and 4 SDCM in between endpoints, provide color accuracy and uniformity.
- Color Temperature (CCT) has an selectable range from 2700K to 5000K (factory default 3000K)
- Optional dedicated 3000K color temperature, color accuracy within 3 SDCM

Optical Assembly

- Regressed lens
- Impact-resistant polycarbonate
- Convex form and lamp-like appearance
- Diffuse for even illumination

Gaskets

- Closed cell gaskets achieve restrictive airflow requirements without additional caulking

Remote Driver/ Junction Box

- Aluminum driver / junction box with captive hinged junction box cover
- Listed for (6) #12 AWG 90° C splice conductors, 2-in, 2-out plus (2) ground
- (2) ½" conduit pry-outs
- (2) Slide-N-Side™ non-metallic (NM) wire traps all
- Accepts 14-2, 14-3, 12-2, 12-3 U.S and 14-2, 14-3, 12-2 Canadian NM cable
- (3) 4-port push wire nuts with clear caps for quick and reliable mains voltage connections
- Integral keyhole mounting slots facilitate direct mounting to building structure or new construction mounting frame

Driver

- Integral 120V 60 Hz constant current driver provides noise free operation
- Continuous, flicker-free dimming from 100% to 5%.
- Plenum rated inline electrical quick connect provides low voltage connection to fixture fitting

Installation

- Can be installed in 1/2" to 1-1/4" thick ceilings
- Cutout can utilize standard round hole saw sizes, cutout template provided
- Heat treated springs hold fixture fitting securely in the ceiling eliminating light leaks
- Can be removed from below the ceiling for service or replacement

Mounting / Retention

- The RL-DM requires no housing or third party junction box
- The remote enclosure may be used in direct contact with insulation.
- Installer must cut template out of drywall and install into aperture with the clips compressed.
- When released, the spring clips will rest on to the back side of the drywall
- Not for installation in recessed cans

Compliance

- UL Certified for US and Canada, type IC suitable for direct contact with air permeable insulation
- Not for use in direct contact with spray foam insulation, reference NEMA LSD57-2013
- Wet and Damp location listed
- Airtight certified per ASTM-E283
- Suitable for use in clothes closets when installed in accordance with the NEC 410.16 spacing requirements
- EMI/RFI emissions per FCC 47CFR Part 15 consumer limits
- Contains no mercury or lead and RoHS compliant
- Photometric testing in accordance with IES LM-79-08
- Lumen maintenance projections in accordance with IES LM-80-08 and TM-21-11
- Can be used for State of California Title 24 high efficacy luminaire compliance. Complies with Title 24 JA8-2016-E.
- Can be used International Energy Conservation Coe (IECC) and Washington State Energy Code high efficiency luminaire compliance.
- ENERGY STAR® listed, reference database for current listings

Warranty

- Five year limited warranty, consult website for details. www.cooperlighting.com/warranty

Dimensional and Mounting Details

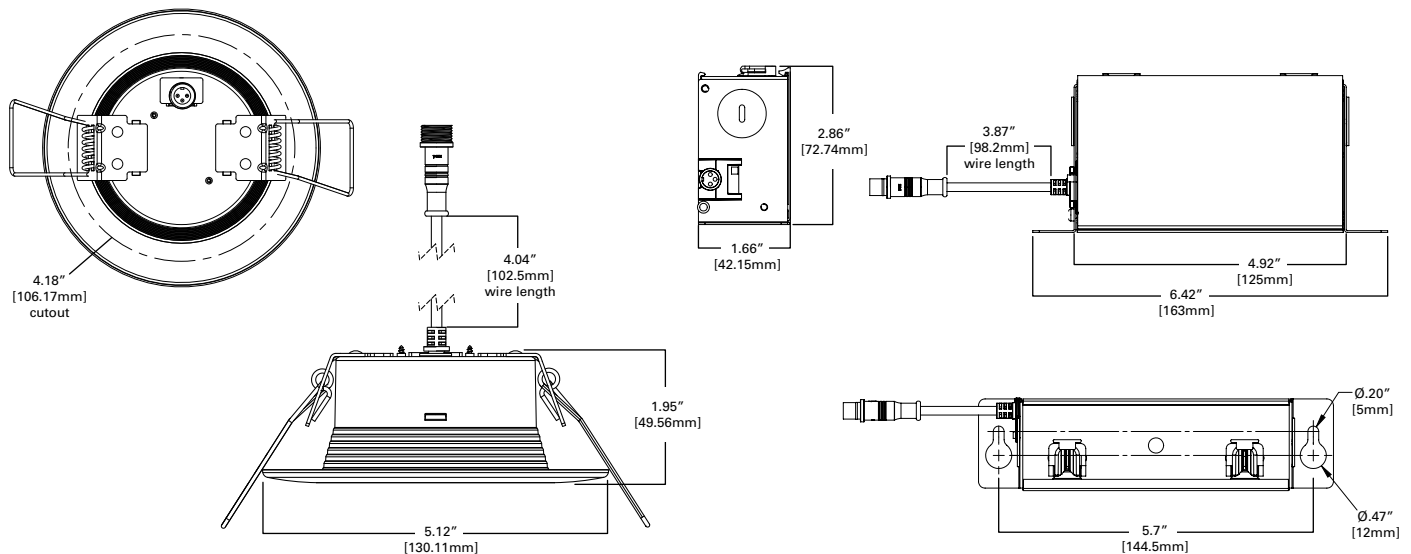

Photometric Data

[View IES files](#)

RL6069S1EWHDM-3000K		
Luminaire lumens	652	
Input watts	8.7	
LER (LPW)	74.9	
Spacing Criteria	0-180	1.18
	90-270	1.18
	Diagonal	1.26
Beam angle (degrees)	93.1	
Field angle (degrees)	141.1	
Zonal lumen	Lumens	% Lumens
0-30	230.2	35.3
0-40	365.1	56
0-60	579	88.8
0-90	652	100

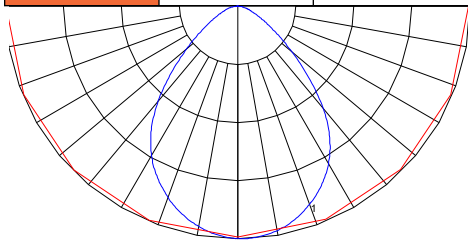

Color Metric Summary - 3000K

TM-30-15	Rf = 90.8
	Rg = 99.7
CRI/CIE	Ra = 93.7
	R9 = 69.3



CCT - Range of 2700K- 5000K



RL4-DM	CCT	Lumens	Power (W)	LPW
Field Selectable CCT	2700K	629.3	8.7	72.3
	3000K	652	8.7	74.9
	3500K	670.8	8.7	77.1
	4000K	685.1	8.7	78.7
	5000K	692.7	8.7	79.6

* Tested in accordance with IES LM63. Field results may vary.

Energy Data

Energy Data @ 3000K	
Lumens	600 Series
Input Voltage	120V
Input Current	74 (mA)
Input Power	8.7 (W)
Efficiency	75 (LPW)
Inrush (A)	2.1 (A)
THD: ≤ 20%	
PF: ≥ 0.90	
T Ambient -30 - +40°C	
Sound Rating ≤ 20dba	

Product Specifications

SeleCCTable RL4069S1EWHDM

PRODUCT SPECIFICATIONS	
Lumens	652
Watts	8.7
Lumens Per Watt (Efficacy)	75
Color Accuracy (CRI)	92
Light Color (CCT)	3000K
Correlated Color Temperature (CCT)	
2700K	3000K
4500K	6500K