

Project		Catalog #		Type	
Prepared by		Notes		Date	



HALO

RL56 | Selectable CCT

5-inch/6-inch All-purpose LED retrofit module with SeleCCTable switch

Typical Applications

Residential

Interactive Menu

- Order Information page 2
- Product Specifications page 3
- Photometric Data page 4
- Energy & Performance Data page 4
- Product Warranty
- Dimming Guide

Product Certification



Refer to ENERGY STAR® Certified Products List.
Can be used to comply with California Title 24 High Efficacy requirements.
Certified to California Appliance Efficiency Database under JAB.

Note: Due to T20 change, as of July 1, 2019 consult factory on correct catalog number and availability for T20 compliant California product.

Product Features



Top Product Features

- Select from 5 CCTs via switch; 2700K, 3000K, 3500K, 4000K, 5000K CCT; 90 CRI
- Lumens: 600, 900, 1200
- Use with 5" or 6" housings with screwbase adapter included
- Dimmable down to 5%
- Dual-mount: Torsion Spring and Push-N-Twist clip models

Dimensional and Mounting Details

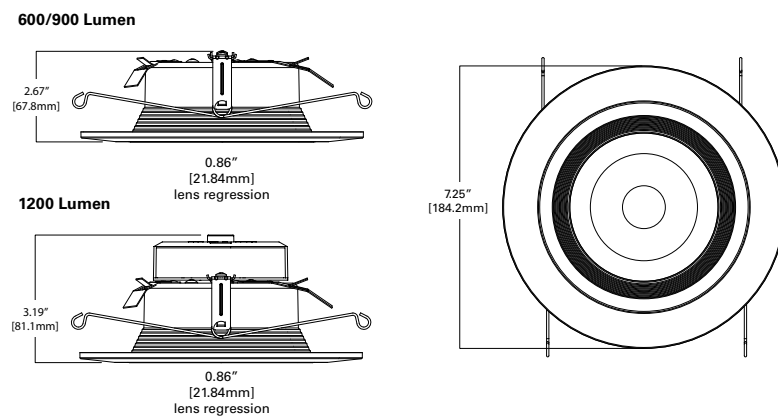

Scale

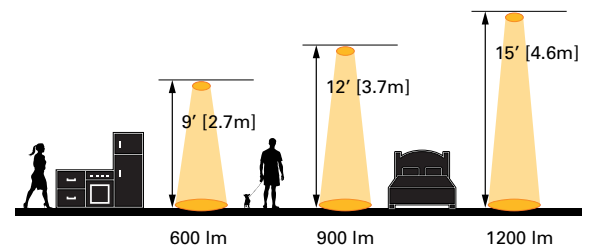

Order Information*

SAMPLE ORDER NUMBER: **RL56069S1EWHR**

Models	Lumens	CRI/CCT	Driver	Finish	Packaging	T20 Compliant
RL56 = 5"/6" all-purpose retrofit LED module	06 = 600 lumens (nominal) 09 = 900 lumens (nominal) 12 = 1200 lumens (nominal)	9S = 90 CRI minimum, white tuning, selectable CCT 2700K-5000K	1E = 120V 60Hz leading or trailing edge phase cut 1% dimming	WH = Matte white baffle	R = Recyclable	-CA
Notes	Notes	Notes	Notes	Notes	Notes	Notes

Accessories

Accessories
<p>Designer Trims</p> <p>RL56TRMWHB = 5"/6" decorative overlay, white paintable, Baffle RL56TRMMBB = 5"/6" decorative overlay, matte black, Baffle RL56TRMSNB = 5"/6" decorative overlay, satin nickel, Baffle RL56TRMTBZB = 5"/6" decorative overlay, tuscan bronze, Baffle</p> <p>RL56TRMWH = 5"/6" decorative overlay, white paintable, trim ring RL56TRMMB = 5"/6" decorative overlay, matte black, trim ring RL56TRMSN = 5"/6" decorative overlay, satin nickel, trim ring RL56TRMTBZ = 5"/6" decorative overlay, tuscan bronze, trim ring</p>
Notes



RL56TRMWHB
White (Paintable), Baffle

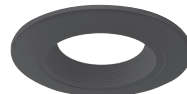

RL56TRMMBB
Matte Black, Baffle

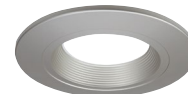

RL56TRMSNB
Satin Nickel, Baffle

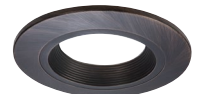

RL56TRMTBZB
Tuscan Bronze, Baffle



RL56TRMWH
White (Paintable), Splay



RL56TRMMB
Matte Black, Splay



RL56TRMSN
Satin Nickel, Splay

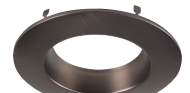

RL56TRMTBZ
Tuscan Bronze, Splay

Housings

Housings	
<p>Halo LED 5-inch</p> <p>H550ICAT = 5" LED, Insulated Ceiling, Air-Tite, New Construction Housing H550RICAT = 5" LED, Insulated Ceiling, Air-Tite, Remodel Housing E550ICAT = 5" LED, Insulated Ceiling, Air-Tite, New Construction Housing E550RICAT = 5" LED, Insulated Ceiling, Air-Tite, Remodel Housing</p> <p>Halo LED 6-inch</p> <p>H750ICAT = 6" LED, Insulated Ceiling, Air-Tite, New Construction Housing H750RICAT = 6" LED, Insulated Ceiling, Air-Tite, Remodel Housing H750T = 6" LED, Non-IC, Air-Tite, New Construction Housing H750TCP = 6" LED, Non-IC, New Construction/Remodel Chicago Plenum Housing H2750ICAT = 6" LED, Shallow, Insulated Ceiling, Air-Tite, New Construction (use with 691X, 694X, 696X trims only) H2750RICAT = 6" LED, Shallow, Insulated Ceiling, Air-Tite, Remodel (use with 691X, 694X, 696X trims only) E750ICAT = 6" LED, Insulated Ceiling, Air-Tite, New Construction Housing E750RICAT = 6" LED, Insulated Ceiling, Air-Tite, Remodel Housing</p> <p>Halo LED retrofit</p> <p>ML7E26RFK = 6" Retrofit Enclosure, Non-IC, E26 Screw base Interface ML7BXFK = 6" Retrofit Enclosure, Non-IC, BX Whip</p> <p>Halo Shallow Housings 5-inch</p> <p>H25ICAT = 5" Shallow, Insulated Ceiling, Air-Tite New Construction H25RICAT = 5" Shallow, Insulated Ceiling, Air-Tite Remodel H25ICATNB = 5" Shallow, Insulated Ceiling, Air-Tite New Construction, No Socket Bracket</p> <p>Halo Shallow Housings 6-inch</p> <p>H27ICAT = 6" Shallow, Insulated Ceiling, Air-Tite New Construction H27RICAT = 6" Shallow, Insulated Ceiling, Air-Tite Remodel Housing H27T = 6" Shallow, Non-IC, New Construction Housing H27RT = 6" Shallow, Non-IC, Remodel Housing E27ICAT = 6" Shallow, Insulated Ceiling, Air-Tite New Construction E27RICAT = 6" Shallow, Insulated Ceiling, Air-Tite Remodel Housing E27TAT = 6" Shallow, Non-IC, New Construction Housing E27RTAT = 6" Shallow, Non-IC, Remodel Housing</p>	<p>Halo Standard Housings 5-inch</p> <p>H5ICAT = 5" Insulated Ceiling, Air-Tite New Construction Housing H5RICAT = 5" Insulated Ceiling, Air-Tite Remodel Housing H5ICATNB = 5" Insulated Ceiling, Air-Tite New Construction Housing, No Socket Bracket H5T = 5" Non-IC, New Construction Housing H5RT = 5" Non-IC, Remodel Housing H5TNB = 5" Non-IC, New Construction Housing, No Socket Bracket E5ICAT = 5" Insulated Ceiling, Air-Tite New Construction Housing E5RICAT = 5" Insulated Ceiling, Air-Tite Remodel Housing E5ICATNB = 5" Insulated Ceiling, Air-Tite New Construction Housing, No Socket Bracket E5TAT = 5" Non-IC, New Construction Housing E5RTAT = 5" Non-IC, Remodel Housing E5TATNB = 5" Non-IC, New Construction Housing, No Socket Bracket</p> <p>Halo Standard Housings 6-inch</p> <p>H7ICAT = 6" Insulated Ceiling, Air-Tite New Construction Housing H7RICAT = 6" Insulated Ceiling, Air-Tite Remodel Housing H7ICT = 6" Insulated Ceiling, New Construction Housing H7RICT = 6" Insulated Ceiling, Remodel Housing H7ICATNB = 6" Insulated Ceiling, Air-Tite New Construction Housing, No Socket Bracket H7ICTNB = 6" Insulated Ceiling, New Construction Housing, No Socket Bracket H7T = 6" Non-IC, New Construction Housing H7RT = 6" Non-IC, Remodel Housing H7TNB = 6" Non-IC, New Construction Housing, No Socket Bracket H7TCP = 6" Non-IC, Chicago Plenum, New Construction/Remodel Housing H7UICAT = 6" Insulated Ceiling, Universal, Air-Tite, New Construction Housing E7ICAT = 6" Insulated Ceiling, Air-Tite New Construction Housing E7RICAT = 6" Insulated Ceiling, Air-Tite Remodel Housing E7ICATNB = 6" Insulated Ceiling, Air-Tite New Construction Housing, No Socket Bracket E7TAT = 6" Non-IC, New Construction Housing E7RTAT = 6" Non-IC, Remodel Housing E7TATNB = 6" Non-IC, New Construction Housing, No Socket Bracket</p>
Notes	

Product Specifications

CCT Select System

- Use the switch to choose between 2700K, 3000K, 3500K, 4000K, and 5000K CCT.

Module - Trim

- Module construction includes LED array, heat sink, reflector, lens, baffle and trim ring.
- Regressed baffle
- Heat sink designed to conduct heat away from the LED array, keeping the junction temperatures below specified maximums, even when installed in insulated ceiling environments.

LED Array

- Mid power LED array provides a uniform source with high efficiency and no pixilation.
- 90 CRI minimum, R9 greater than 50
- Color accuracy at 4 SDCM in between endpoints, provide color accuracy and uniformity.
- Color Temperature (CCT) has a selectable range from 2700K to 5000K (factory default 3000K)

Optical Assembly

- Regressed lens
- Impact-resistant polycarbonate
- Convex form and lamp-like appearance
- Diffuse for even illumination

Driver

- Integral 120V 60 Hz constant current driver provides noise free operation
- Continuous, flicker-free dimming from 100% to 5%.
- Inline electrical quick connect and E26 adapter (provided) provides mains connections
- See Dimming Guide for compatible dimmers

Retention

- Integral torsion springs and Push-N-Twist clips offer two mounting options
- Torsion springs are pre-installed and adjust to fit 5" or 6" compatible housings
- Push-N-Twist universal installation clips are pre-installed and designed to fit 5" or 6" compatible housings

Designer Skins (sold separately)

- RL56 skins are accessory rings that attach to the RL56 for a permanent finish. Refer to the RL56 accessories specification sheet for details.
 - White (Paintable)
 - Satin Nickel
 - Tuscan Bronze

Gaskets

- Closed cell gaskets achieve restrictive airflow requirements without additional caulking

Compliance

- UL Certified
- Wet and Damp location listed.
- Airtight certified per ASTM-E283
- Suitable for use in clothes closets when installed in accordance with the NEC 410.16 spacing requirements
- EMI/RFI emissions per FCC 47CFR Part 15 consumer limits
- Contains no mercury or lead and RoHS compliant
- Photometric testing in accordance with IES LM-79-08
- Lumen maintenance projections in accordance with IES LM-80-08 and TM-21-11
- Can be used for State of California Title 24 high efficacy luminaire compliance. Complies with Title 24 JA8-2016-E.
- Can be used International Energy Conservation Code (IECC) high efficiency luminaire compliance.
- ENERGY STAR® listed, reference database for current listings

Warranty

- Five year limited warranty, consult website for details. www.cooperlighting.com/warranty

Photometric Data

View IES files

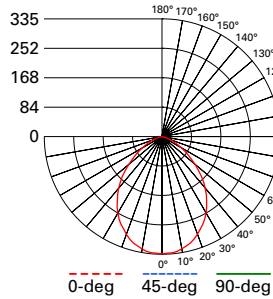

RL56069S1EWHR-3000K

Spacing criterion: (0-180) 1.14
(90-270) 1.14
(Diagonal) 1.22

Beam Angle: 87.8°
Field Angle: 139°
Lumens: 693
Input Watts: 7.9 W
Efficacy: 87.7 LPW
Test Report:
RL56069S1EWHR-3000K.ies

Zonal Lumen	Lumens	% Lumens
0-30	247	37.2
0-40	387	58.2
0-60	595	89.4
0-90	665	100

TM-30-15	Rf = 89.8 Rg = 98
CRI/CIE	Ra = 93.7 R9 = 69.1

CCT - Range of 2700K- 5000K



93°

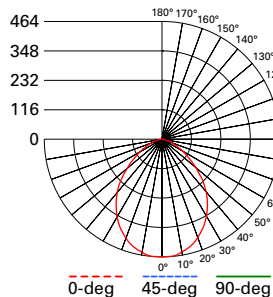

RL56099S1EWHR-3000K

Spacing criterion: (0-180) 1.16
(90-270) 1.16
(Diagonal) 1.22

Beam Angle: 88.9°
Field Angle: 140°
Lumens: 957
Input Watts: 11.5 W
Efficacy: 83.2 LPW
Test Report:
RL56099S1EWHR-3000K.ies

Zonal Lumen	Lumens	% Lumens
0-30	345	36.7
0-40	541	57.5
0-60	838	89.1
0-90	940	100

TM-30-15	Rf = 89.8 Rg = 97.7
CRI/CIE	Ra = 93.1 R9 = 64.6

CCT - Range of 2700K- 5000K

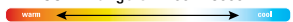

93°

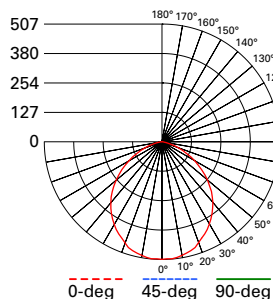

RL56129S1EWHR-3000K

Spacing criterion: (0-180) 1.21
(90-270) 1.21
(Diagonal) 1.31

Beam Angle: 93°
Field Angle: 140°
Lumens: 1399
Input Watts: 14.2 W
Efficacy: 91.5 LPW
Test Report:
RL56129S1EWHR-3000K.ies

Zonal Lumen	Lumens	% Lumens
0-30	345	31.7
0-40	541	51.5
0-60	838	85.5
0-90	940	100

TM-30-15	Rf = 89.8 Rg = 97.7
CRI/CIE	Ra = 93.1 R9 = 64.6

CCT - Range of 2700K- 5000K



93°

Energy and Performance Data

RL56069S1EWHR	
Max. Lumens	736 @ 5000K
Input Voltage	120V
Input Frequency	50/60 Hz
Input Power	7.9W
Input Current	0.15 A
Power Factor	>0.90
THD	<20%
EMI/RFI	FCC Title 47 CFR, Part 15, Class B (Consumer)
Sound Rating	Class A
Minimum Starting Temp	-30°C (-22°F)

RL56099S1EWHR	
Max. Lumens	1012 @ 5000K
Input Voltage	120V
Input Frequency	50/60 Hz
Input Power	11.4W
Input Current	0.15 A
Power Factor	>0.90
THD	<20%
EMI/RFI	FCC Title 47 CFR, Part 15, Class B (Consumer)
Sound Rating	Class A
Minimum Starting Temp	-30°C (-22°F)

RL56129S1EWHR	
Max. Lumens	1399 @ 5000K
Input Voltage	120V
Input Frequency	50/60 Hz
Input Power	14.1W
Input Current	0.15 A
Power Factor	>0.90
THD	<20%
EMI/RFI	FCC Title 47 CFR, Part 15, Class B (Consumer)
Sound Rating	Class A
Minimum Starting Temp	-30°C (-22°F)

Tested in accordance with IES LM63. Field results may vary.

Note: Refer to IES files for more product data.

Photometric Data

View IES files

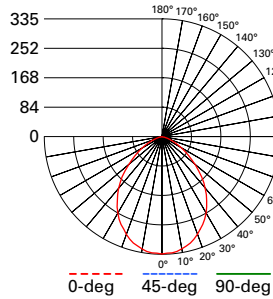

RL56069S1EWHR-CA-3000K
 Spacing criterion: (0-180) 1.14
 (90-270) 1.14
 (Diagonal) 1.22
 Beam Angle: 87.8°
 Field Angle: 139°
 Lumens: 665
 Input Watts: 7.6 W
 Efficacy: 87.5 LPW
 Test Report:
 RL56069S1EWHR-CA-3000K.ies

Zonal Lumen	Lumens	% Lumens
0-30	247	37.2
0-40	387	58.2
0-60	595	89.4
0-90	665	100

TM-30-15	Rf = 89.8
	Rg = 98
CRI/CIE	Ra = 93.7
	R9 = 69.1

CCT - Range of 2700K- 5000K



93°

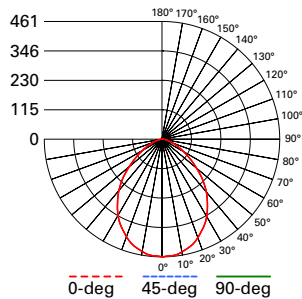

RL56099S1EWHR-CA-3000K
 Spacing criterion: (0-180) 1.13
 (90-270) 1.13
 (Diagonal) 1.21
 Beam Angle: 88.9°
 Field Angle: 140°
 Lumens: 923
 Input Watts: 9.9 W
 Efficacy: 93.1 LPW
 Test Report:
 RL56099S1EWHR-CA-3000K.ies

Zonal Lumen	Lumens	% Lumens
0-30	343	37.2
0-40	536	58.1
0-60	824	89.4
0-90	922	100

TM-30-15	Rf = 89.8
	Rg = 97.7
CRI/CIE	Ra = 93.1
	R9 = 64.6

CCT - Range of 2700K- 5000K

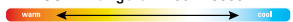

93°

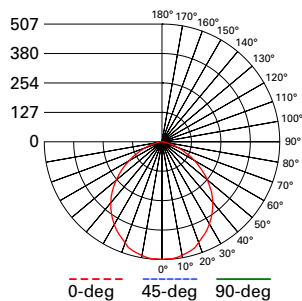

RL56129S1EWHR-CA-3000K
 Spacing criterion: (0-180) 1.21
 (90-270) 1.21
 (Diagonal) 1.31
 Beam Angle: 93°
 Field Angle: 140°
 Lumens: 1221
 Input Watts: 14 W
 Efficacy: 87.2 LPW
 Test Report:
 RL56129S1EWHR-CA-3000K.ies

Zonal Lumen	Lumens	% Lumens
0-30	345	31.7
0-40	541	51.5
0-60	838	85.5
0-90	940	100

TM-30-15	Rf = 89.8
	Rg = 97.7
CRI/CIE	Ra = 93.1
	R9 = 64.6

CCT - Range of 2700K- 5000K



93°

Energy and Performance Data

RL56069S1EWHR-CA	
Max. Lumens	712 @ 4000K
Input Voltage	120V
Input Frequency	50/60 Hz
Input Power	7.6W
Input Current	0.15 A
Power Factor	>0.90
THD	<20%
EMI/RFI	FCC Title 47 CFR, Part 15, Class B (Consumer)
Sound Rating	Class A
Minimum Starting Temp	-30°C (-22°F)

RL56099S1EWHR-CA	
Max. Lumens	946 @ 4000K
Input Voltage	120V
Input Frequency	50/60 Hz
Input Power	9.9W
Input Current	0.15 A
Power Factor	>0.90
THD	<20%
EMI/RFI	FCC Title 47 CFR, Part 15, Class B (Consumer)
Sound Rating	Class A
Minimum Starting Temp	-30°C (-22°F)

RL56129S1EWHR-CA	
Max. Lumens	1272 @ 5000K
Input Voltage	120V
Input Frequency	50/60 Hz
Input Power	14W
Input Current	0.15 A
Power Factor	>0.90
THD	<20%
EMI/RFI	FCC Title 47 CFR, Part 15, Class B (Consumer)
Sound Rating	Class A
Minimum Starting Temp	-30°C (-22°F)

Project		Catalog #		Type	
Prepared by		Notes		Date	



HALO

RL56 | Selectable CCT

5-inch/6-inch All-purpose LED retrofit module with SeleCCTable switch

Typical Applications

Residential

Interactive Menu

- Order Information page 2
- Product Specifications page 3
- Photometric Data page 4
- Energy & Performance Data page 4
- Product Warranty
- Dimming Guide

Product Certification



Refer to ENERGY STAR® Certified Products List.
Can be used to comply with California Title 24 High Efficacy requirements.
Certified to California Appliance Efficiency Database under JAB.

Note: Due to T20 change, as of July 1, 2019 consult factory on correct catalog number and availability for T20 compliant California product.

Product Features



Top Product Features

- Select from 5 CCTs via switch; 2700K, 3000K, 3500K, 4000K, 5000K CCT; 90 CRI
- Lumens: 600, 900, 1200
- Use with 5" or 6" housings with screwbase adapter included
- Dimmable down to 5%
- Dual-mount: Torsion Spring and Push-N-Twist clip models

Dimensional and Mounting Details

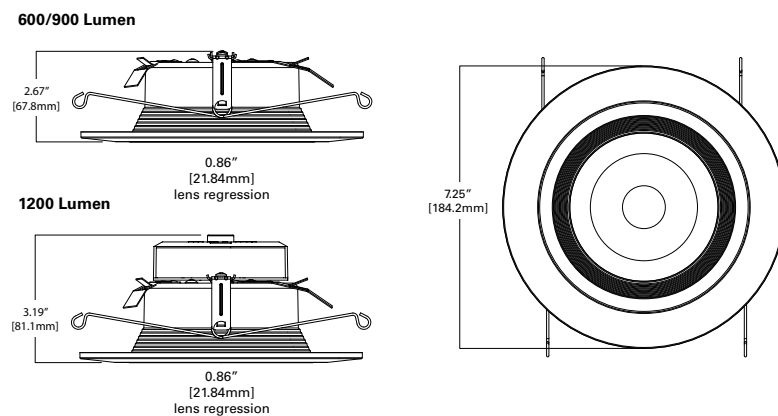

Scale

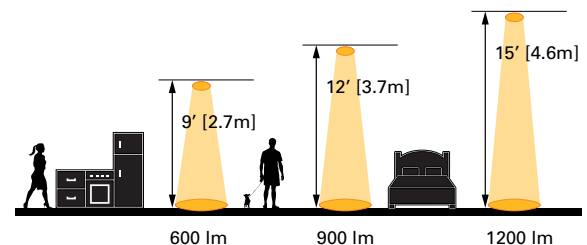

Order Information*

SAMPLE ORDER NUMBER: **RL56069S1EWHR**

Models	Lumens	CRI/CCT	Driver	Finish	Packaging	T20 Compliant
RL56 = 5"/6" all-purpose retrofit LED module	06 = 600 lumens (nominal) 09 = 900 lumens (nominal) 12 = 1200 lumens (nominal)	9S = 90 CRI minimum, white tuning, selectable CCT 2700K-5000K	1E = 120V 60Hz leading or trailing edge phase cut 1% dimming	WH = Matte white baffle	R = Recyclable	-CA
Notes	Notes	Notes	Notes	Notes	Notes	Notes

Accessories

Accessories
<p>Designer Trims</p> <p>RL56TRMWHB = 5"/6" decorative overlay, white paintable, Baffle RL56TRMMBB = 5"/6" decorative overlay, matte black, Baffle RL56TRMSNB = 5"/6" decorative overlay, satin nickel, Baffle RL56TRMTBZB = 5"/6" decorative overlay, tuscan bronze, Baffle</p> <p>RL56TRMWH = 5"/6" decorative overlay, white paintable, trim ring RL56TRMMB = 5"/6" decorative overlay, matte black, trim ring RL56TRMSN = 5"/6" decorative overlay, satin nickel, trim ring RL56TRMTBZ = 5"/6" decorative overlay, tuscan bronze, trim ring</p>
Notes



RL56TRMWHB
White (Paintable), Baffle

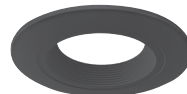

RL56TRMMBB
Matte Black, Baffle

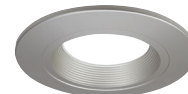

RL56TRMSNB
Satin Nickel, Baffle

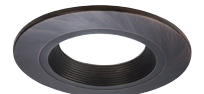

RL56TRMTBZB
Tuscan Bronze, Baffle



RL56TRMWH
White (Paintable), Splay



RL56TRMMB
Matte Black, Splay



RL56TRMSN
Satin Nickel, Splay

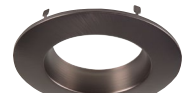

RL56TRMTBZ
Tuscan Bronze, Splay

Housings

Housings	
<p>Halo LED 5-inch</p> <p>H550ICAT = 5" LED, Insulated Ceiling, Air-Tite, New Construction Housing H550RICAT = 5" LED, Insulated Ceiling, Air-Tite, Remodel Housing E550ICAT = 5" LED, Insulated Ceiling, Air-Tite, New Construction Housing E550RICAT = 5" LED, Insulated Ceiling, Air-Tite, Remodel Housing</p> <p>Halo LED 6-inch</p> <p>H750ICAT = 6" LED, Insulated Ceiling, Air-Tite, New Construction Housing H750RICAT = 6" LED, Insulated Ceiling, Air-Tite, Remodel Housing H750T = 6" LED, Non-IC, Air-Tite, New Construction Housing H750TCP = 6" LED, Non-IC, New Construction/Remodel Chicago Plenum Housing H2750ICAT = 6" LED, Shallow, Insulated Ceiling, Air-Tite, New Construction (use with 691X, 694X, 696X trims only) H2750RICAT = 6" LED, Shallow, Insulated Ceiling, Air-Tite, Remodel (use with 691X, 694X, 696X trims only) E750ICAT = 6" LED, Insulated Ceiling, Air-Tite, New Construction Housing E750RICAT = 6" LED, Insulated Ceiling, Air-Tite, Remodel Housing</p> <p>Halo LED retrofit</p> <p>ML7E26RFK = 6" Retrofit Enclosure, Non-IC, E26 Screw base Interface ML7BXFK = 6" Retrofit Enclosure, Non-IC, BX Whip</p> <p>Halo Shallow Housings 5-inch</p> <p>H25ICAT = 5" Shallow, Insulated Ceiling, Air-Tite New Construction H25RICAT = 5" Shallow, Insulated Ceiling, Air-Tite Remodel H25ICATNB = 5" Shallow, Insulated Ceiling, Air-Tite New Construction, No Socket Bracket</p> <p>Halo Shallow Housings 6-inch</p> <p>H27ICAT = 6" Shallow, Insulated Ceiling, Air-Tite New Construction H27RICAT = 6" Shallow, Insulated Ceiling, Air-Tite Remodel Housing H27T = 6" Shallow, Non-IC, New Construction Housing H27RT = 6" Shallow, Non-IC, Remodel Housing E27ICAT = 6" Shallow, Insulated Ceiling, Air-Tite New Construction E27RICAT = 6" Shallow, Insulated Ceiling, Air-Tite Remodel Housing E27TAT = 6" Shallow, Non-IC, New Construction Housing E27RTAT = 6" Shallow, Non-IC, Remodel Housing</p>	<p>Halo Standard Housings 5-inch</p> <p>H5ICAT = 5" Insulated Ceiling, Air-Tite New Construction Housing H5RICAT = 5" Insulated Ceiling, Air-Tite Remodel Housing H5ICATNB = 5" Insulated Ceiling, Air-Tite New Construction Housing, No Socket Bracket H5T = 5" Non-IC, New Construction Housing H5RT = 5" Non-IC, Remodel Housing H5TNB = 5" Non-IC, New Construction Housing, No Socket Bracket E5ICAT = 5" Insulated Ceiling, Air-Tite New Construction Housing E5RICAT = 5" Insulated Ceiling, Air-Tite Remodel Housing E5ICATNB = 5" Insulated Ceiling, Air-Tite New Construction Housing, No Socket Bracket E5TAT = 5" Non-IC, New Construction Housing E5RTAT = 5" Non-IC, Remodel Housing E5TATNB = 5" Non-IC, New Construction Housing, No Socket Bracket</p> <p>Halo Standard Housings 6-inch</p> <p>H7ICAT = 6" Insulated Ceiling, Air-Tite New Construction Housing H7RICAT = 6" Insulated Ceiling, Air-Tite Remodel Housing H7ICT = 6" Insulated Ceiling, New Construction Housing H7RICT = 6" Insulated Ceiling, Remodel Housing H7ICATNB = 6" Insulated Ceiling, Air-Tite New Construction Housing, No Socket Bracket H7ICTNB = 6" Insulated Ceiling, New Construction Housing, No Socket Bracket H7T = 6" Non-IC, New Construction Housing H7RT = 6" Non-IC, Remodel Housing H7TNB = 6" Non-IC, New Construction Housing, No Socket Bracket H7TCP = 6" Non-IC, Chicago Plenum, New Construction/Remodel Housing H7UICAT = 6" Insulated Ceiling, Universal, Air-Tite, New Construction Housing E7ICAT = 6" Insulated Ceiling, Air-Tite New Construction Housing E7RICAT = 6" Insulated Ceiling, Air-Tite Remodel Housing E7ICATNB = 6" Insulated Ceiling, Air-Tite New Construction Housing, No Socket Bracket E7TAT = 6" Non-IC, New Construction Housing E7RTAT = 6" Non-IC, Remodel Housing E7TATNB = 6" Non-IC, New Construction Housing, No Socket Bracket</p>
Notes	

Product Specifications

CCT Select System

- Use the switch to choose between 2700K, 3000K, 3500K, 4000K, and 5000K CCT.

Module - Trim

- Module construction includes LED array, heat sink, reflector, lens, baffle and trim ring.
- Regressed baffle
- Heat sink designed to conduct heat away from the LED array, keeping the junction temperatures below specified maximums, even when installed in insulated ceiling environments.

LED Array

- Mid power LED array provides a uniform source with high efficiency and no pixilation.
- 90 CRI minimum, R9 greater than 50
- Color accuracy at 4 SDCM in between endpoints, provide color accuracy and uniformity.
- Color Temperature (CCT) has a selectable range from 2700K to 5000K (factory default 3000K)

Optical Assembly

- Regressed lens
- Impact-resistant polycarbonate
- Convex form and lamp-like appearance
- Diffuse for even illumination

Driver

- Integral 120V 60 Hz constant current driver provides noise free operation
- Continuous, flicker-free dimming from 100% to 5%.
- Inline electrical quick connect and E26 adapter (provided) provides mains connections
- See Dimming Guide for compatible dimmers

Retention

- Integral torsion springs and Push-N-Twist clips offer two mounting options
- Torsion springs are pre-installed and adjust to fit 5" or 6" compatible housings
- Push-N-Twist universal installation clips are pre-installed and designed to fit 5" or 6" compatible housings

Designer Skins (sold separately)

- RL56 skins are accessory rings that attach to the RL56 for a permanent finish. Refer to the RL56 accessories specification sheet for details.
 - White (Paintable)
 - Satin Nickel
 - Tuscan Bronze

Gaskets

- Closed cell gaskets achieve restrictive airflow requirements without additional caulking

Compliance

- UL Certified
- Wet and Damp location listed.
- Airtight certified per ASTM-E283
- Suitable for use in clothes closets when installed in accordance with the NEC 410.16 spacing requirements
- EMI/RFI emissions per FCC 47CFR Part 15 consumer limits
- Contains no mercury or lead and RoHS compliant
- Photometric testing in accordance with IES LM-79-08
- Lumen maintenance projections in accordance with IES LM-80-08 and TM-21-11
- Can be used for State of California Title 24 high efficacy luminaire compliance. Complies with Title 24 JA8-2016-E.
- Can be used International Energy Conservation Code (IECC) high efficiency luminaire compliance.
- ENERGY STAR® listed, reference database for current listings

Warranty

- Five year limited warranty, consult website for details. www.cooperlighting.com/warranty

Photometric Data

View IES files

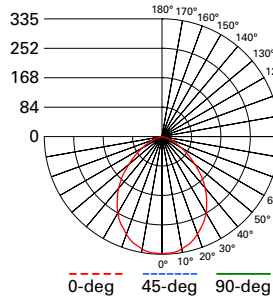

RL56069S1EWHR-3000K

Spacing criterion: (0-180) 1.14
(90-270) 1.14
(Diagonal) 1.22

Beam Angle: 87.8°
Field Angle: 139°
Lumens: 693
Input Watts: 7.9 W
Efficacy: 87.7 LPW
Test Report:
RL56069S1EWHR-3000K.ies

Zonal Lumen	Lumens	% Lumens
0-30	247	37.2
0-40	387	58.2
0-60	595	89.4
0-90	665	100

TM-30-15	Rf = 89.8
	Rg = 98
CRI/CIE	Ra = 93.7
	R9 = 69.1

CCT - Range of 2700K- 5000K



93°

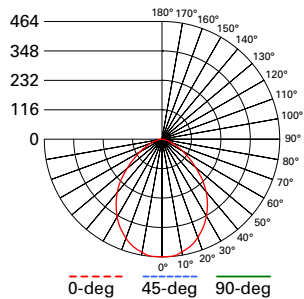

RL56099S1EWHR-3000K

Spacing criterion: (0-180) 1.16
(90-270) 1.16
(Diagonal) 1.22

Beam Angle: 88.9°
Field Angle: 140°
Lumens: 957
Input Watts: 11.5 W
Efficacy: 83.2 LPW
Test Report:
RL56099S1EWHR-3000K.ies

Zonal Lumen	Lumens	% Lumens
0-30	345	36.7
0-40	541	57.5
0-60	838	89.1
0-90	940	100

TM-30-15	Rf = 89.8
	Rg = 97.7
CRI/CIE	Ra = 93.1
	R9 = 64.6

CCT - Range of 2700K- 5000K



93°

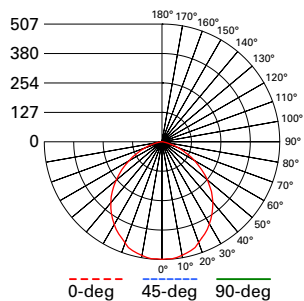

RL56129S1EWHR-3000K

Spacing criterion: (0-180) 1.21
(90-270) 1.21
(Diagonal) 1.31

Beam Angle: 93°
Field Angle: 140°
Lumens: 1399
Input Watts: 14.2 W
Efficacy: 91.5 LPW
Test Report:
RL56129S1EWHR-3000K.ies

Zonal Lumen	Lumens	% Lumens
0-30	345	31.7
0-40	541	51.5
0-60	838	85.5
0-90	940	100

TM-30-15	Rf = 89.8
	Rg = 97.7
CRI/CIE	Ra = 93.1
	R9 = 64.6

CCT - Range of 2700K- 5000K



93°

Energy and Performance Data

RL56069S1EWHR	
Max. Lumens	736 @ 5000K
Input Voltage	120V
Input Frequency	50/60 Hz
Input Power	7.9W
Input Current	0.15 A
Power Factor	>0.90
THD	<20%
EMI/RFI	FCC Title 47 CFR, Part 15, Class B (Consumer)
Sound Rating	Class A
Minimum Starting Temp	-30°C (-22°F)

RL56099S1EWHR	
Max. Lumens	1012 @ 5000K
Input Voltage	120V
Input Frequency	50/60 Hz
Input Power	11.4W
Input Current	0.15 A
Power Factor	>0.90
THD	<20%
EMI/RFI	FCC Title 47 CFR, Part 15, Class B (Consumer)
Sound Rating	Class A
Minimum Starting Temp	-30°C (-22°F)

RL56129S1EWHR	
Max. Lumens	1399 @ 5000K
Input Voltage	120V
Input Frequency	50/60 Hz
Input Power	14.1W
Input Current	0.15 A
Power Factor	>0.90
THD	<20%
EMI/RFI	FCC Title 47 CFR, Part 15, Class B (Consumer)
Sound Rating	Class A
Minimum Starting Temp	-30°C (-22°F)

Tested in accordance with IES LM63. Field results may vary.

Note: Refer to IES files for more product data.

Photometric Data

View IES files

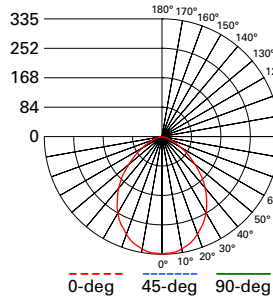

RL56069S1EWHR-CA-3000K
 Spacing criterion: (0-180) 1.14
 (90-270) 1.14
 (Diagonal) 1.22
 Beam Angle: 87.8°
 Field Angle: 139°
 Lumens: 665
 Input Watts: 7.6 W
 Efficacy: 87.5 LPW
 Test Report:
 RL56069S1EWHR-CA-3000K.ies

Zonal Lumen	Lumens	% Lumens
0-30	247	37.2
0-40	387	58.2
0-60	595	89.4
0-90	665	100

TM-30-15	Rf = 89.8
	Rg = 98
CRI/CIE	Ra = 93.7
	R9 = 69.1

CCT - Range of 2700K- 5000K



93°

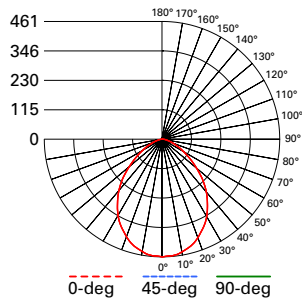

RL56099S1EWHR-CA-3000K
 Spacing criterion: (0-180) 1.13
 (90-270) 1.13
 (Diagonal) 1.21
 Beam Angle: 88.9°
 Field Angle: 140°
 Lumens: 923
 Input Watts: 9.9 W
 Efficacy: 93.1 LPW
 Test Report:
 RL56099S1EWHR-CA-3000K.ies

Zonal Lumen	Lumens	% Lumens
0-30	343	37.2
0-40	536	58.1
0-60	824	89.4
0-90	922	100

TM-30-15	Rf = 89.8
	Rg = 97.7
CRI/CIE	Ra = 93.1
	R9 = 64.6

CCT - Range of 2700K- 5000K



93°

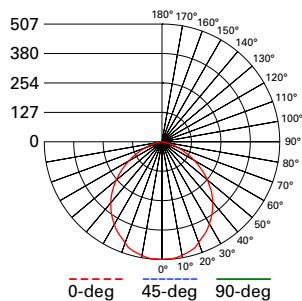

RL56129S1EWHR-CA-3000K
 Spacing criterion: (0-180) 1.21
 (90-270) 1.21
 (Diagonal) 1.31
 Beam Angle: 93°
 Field Angle: 140°
 Lumens: 1221
 Input Watts: 14 W
 Efficacy: 87.2 LPW
 Test Report:
 RL56129S1EWHR-CA-3000K.ies

Zonal Lumen	Lumens	% Lumens
0-30	345	31.7
0-40	541	51.5
0-60	838	85.5
0-90	940	100

TM-30-15	Rf = 89.8
	Rg = 97.7
CRI/CIE	Ra = 93.1
	R9 = 64.6

CCT - Range of 2700K- 5000K



93°

Energy and Performance Data

RL56069S1EWHR-CA	
Max. Lumens	712 @ 4000K
Input Voltage	120V
Input Frequency	50/60 Hz
Input Power	7.6W
Input Current	0.15 A
Power Factor	>0.90
THD	<20%
EMI/RFI	FCC Title 47 CFR, Part 15, Class B (Consumer)
Sound Rating	Class A
Minimum Starting Temp	-30°C (-22°F)

RL56099S1EWHR-CA	
Max. Lumens	946 @ 4000K
Input Voltage	120V
Input Frequency	50/60 Hz
Input Power	9.9W
Input Current	0.15 A
Power Factor	>0.90
THD	<20%
EMI/RFI	FCC Title 47 CFR, Part 15, Class B (Consumer)
Sound Rating	Class A
Minimum Starting Temp	-30°C (-22°F)

RL56129S1EWHR-CA	
Max. Lumens	1272 @ 5000K
Input Voltage	120V
Input Frequency	50/60 Hz
Input Power	14W
Input Current	0.15 A
Power Factor	>0.90
THD	<20%
EMI/RFI	FCC Title 47 CFR, Part 15, Class B (Consumer)
Sound Rating	Class A
Minimum Starting Temp	-30°C (-22°F)