

Description

The Halo RL560 is a complete LED Baffle-Trim Module for 5" and 6" aperture recessed downlights; suitable for new construction, remodel and retrofit installation. The RL560 is cULus Listed for use with Halo and All-Pro, and is UL Classified for use with other compatible 5" and 6" housings. The RL560 with integral LED driver offers 120 volt dimming capability. The RL560 lens provides uniform illumination and wet location listing. Precision construction makes any housing AIR-TITE for added HVAC savings and code compliance. Compliant with NFPA 70, NEC section 410.16 (A)(1) and 410.16 (C)(3).

Catalog #		Type
Project		
Comments		Date
Prepared by		

Specification Features

MECHANICAL

Module - Trim

- Module construction includes LED, heat sink, reflector, lens, baffle and trim ring
- Regressed baffle
- Heat sink designed to conduct heat away from the LED keeping the junction temperatures below specified maximums, even when installed in insulated ceiling environments
- Designer trim finish options (sold separately)
 - White (Paintable) Trim Ring
 - Satin Nickel Trim Ring
 - Tuscan Bronze Trim Ring

Lens

- Regressed lens
- Impact-resistant polycarbonate
- Convex form for lamp-like appearance
- High lumen transmission
- Diffusing for even illumination

Mounting

- Integral torsion springs and Push-N-Twist clips offer two mounting options
 - Torsion springs are pre-installed and adjust to fit 5" or 6" compatible housings
 - Push-N-Twist universal installation clips are pre-installed and designed to fit 5" or 6" compatible housings

Housing Compatibility

See Housing Compatibility

LED

- Color Temperature (CCT)* Options: 2700K, 3000K, 3500K, and 4000K
- CRI options: 80 and 90†
 - 90 CRI can be used for California Title 24 compliance/certified to Title 20
 - 80 CRI can be used to comply with California Title 24 Non-Residential Lighting Controls requirements as an LED luminaire

LED Chromaticity

- A tight chromaticity specification ensures LED color uniformity, sustainable Color Rendering Index (CRI) and Correlated Color Temperature (CCT) over the useful life of the LED
- LED chromaticity of 3 SDCM exceeds ENERGY STAR® color standards per ANSI C78.377-2008
- 90 CRI model features high color performance with R9 greater than 50
- Every Halo LED is quality tested, measured, and serialized in a permanent record to register lumens, wattage, CRI and CCT
- Halo LED serialized testing and measurement ensures color and lumen consistency on a per-unit basis, and validates long-term product consistency over time

ELECTRICAL

Power Connections

- LED connector is a non-screw base luminaire disconnect offering easy installation with the matching Halo 5" and 6" LED housings
- LED Connector meets California Title-24 high efficacy luminaire requirement for a non-screw base socket, and where required to qualify as a high efficacy luminaire
- The included E26 medium screw-base Edison adapter provides easy retrofit of incandescent housings (see Housing Compatibility)

Ground Connection

Separate grounding cable included on the module for attachment to the housing during installation.

LED Driver

- Dimmable driver is a 120 Volt, high efficiency, electronic power supply providing DC power to the LED
- Driver meets FCC EMI/RFI Consumer Level limits for use in residential and commercial installations

- Driver features high power factor, low THD, and has integral thermal protection in the event of over temperature or internal failure

Dimming

- Designed for continuous dimming capability to nominally 5% with many 120V Leading Edge (LE) and Trailing Edge (TE) Phase Control dimmers. (Dimmers with low end trim adjustment offer greater assurance of achieving 5% level.)
- Consult dimmer manufacturer for compatibility and conditions of use

Note: some dimmers require a neutral in the wallbox.

Warranty

Cooper Lighting provides a five year limited warranty on RL56 LED.

Compliance Labels

- UL/cUL Listed 1598 Luminaire (with listed housings)
- UL Classified (with other housings - see Housing Compatibility)
- UL/cUL Listed for Damp Location
- UL/cUL Listed for Wet Location – Shower Applications
- IP56 Ingress Protection rated
- May be installed in housings in direct contact with insulation** and combustible material

Compliance

- Airtight certified per ASTM E283 (not exceeding 2.0 CFM under 75 Pascals pressure difference)
- 90 CRI: Can be used to comply with California Title 24 High Efficacy requirements. Certified to California Title 20 Appliance Efficiency Database.*
- 80 CRI: Can be used to comply with California Title 24 Non-Residential Lighting Controls requirements as an LED luminaire
- Can be used for International Energy Conservation Code (IECC) high efficiency luminaire compliance



RL560WH9†

White

**900 Series
5/6-Inch LED
Recessed Retrofit
Module-Trim**

**80CRI
2700K, 3000K,
3500K, 4000K**

**90CRI
2700K, 3000K,
3500K, 4000K**

**FOR USE IN
INSULATED CEILING
AND NON- INSULATED
CEILING RATED
HOUSINGS**

**HIGH EFFICACY LED
WITH INTEGRAL
DRIVER - DIMMABLE**

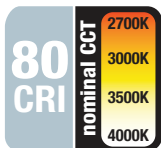

Refer to ENERGY STAR® Certified Products List.

Can be used to comply with California Title 24 Non-Residential Lighting Controls requirements as a LED Luminaire.

* Refer to ENERGY STAR® Certified Products List and CEC (T20) Appliance Database for listings.

** Not for use with housings in direct contact with spray foam insulation.

† See ordering information table for available models.



Refer to ENERGY STAR® Certified Products List.

Can be used to comply with California Title 24 High Efficacy requirements.

Certified to California Title 20 Appliance Efficiency Database.

Specification Features (continued)

- Can be used for Washington State Energy Code compliance
- ENERGY STAR® Certified luminaire - consult ENERGY STAR® Certified Product List*
- EMI/RFI per FCC 47CFR Part 15 Class B Consumer limits, suitable for use in residential and commercial installations
- Contains no mercury or lead and RoHS compliant
- Photometric testing in accordance with IES LM-79
- Lumen maintenance projections in accordance with IES LM-80 and TM-21
- Suitable for use in closets. Compliant with NFPA 70, NEC Sec. 410.16 (A)(1) and 410.16 (C)(3).

RL56 Dimensions

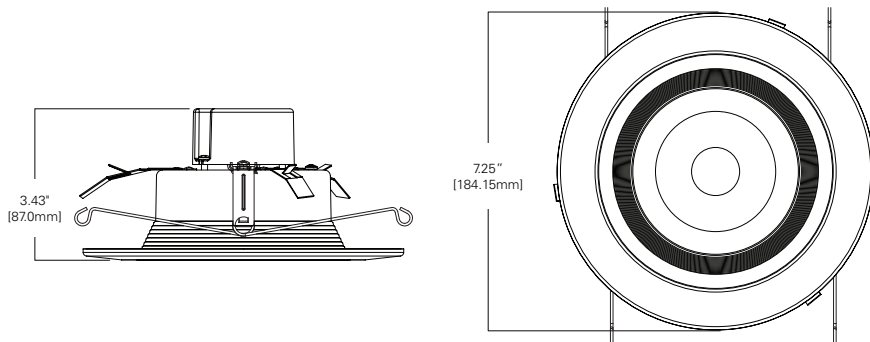

Energy Data

RL56 Series (Values at non-dimming line voltage)

Minimum Starting Temp: -30°C (-22°F)
EMI/RFI: FCC Title 47 CFR, Part 15, Class B (Consumer)
Sound Rating: Class A
Input Voltage: 120V
Power Factor: >0.90
Input Frequency: 60Hz
THD: <20%
Input Power: 13.5W
Input Current: 0.15A
Maximum IC (Insulated Ceiling) Ambient Continuous Operating Temperature: 25°C (77°F)
Maximum Non-IC Ambient Continuous Operating Temperature 40°C (104°F)

Designer Trim Dimensions

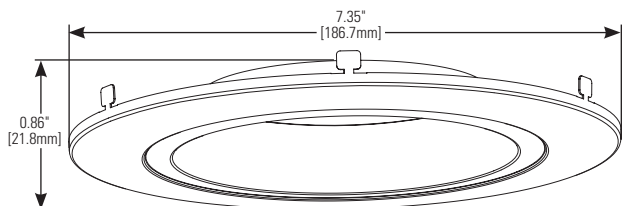

RL56TRMWH
White (Paintable)

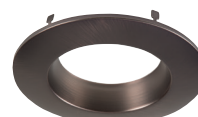

RL56TRMTBZ
Tuscan Bronze



RL56TRMSN
Satin Nickel

Performance Data

Catalog #	CRI	Lumens	LPW	Watts	CCT
RL560WH9827	80	1000	74	13.5	2700K
RL560WH9830	80	1030	76	13.5	3000K
RL560WH9835	80	1080	80	13.5	3500K
RL560WH9840	80	1100	81	13.5	4000K
RL560WH9927	90	850	63	13.5	2700K
RL560WH9930	90	885	66	13.5	3000K
RL560WH9935	90	910	67	13.5	3500K
RL560WH9940	90	930	69	13.5	4000K

Ordering Information

Sample Number: **RL560WH9827-RL56TRMSN**

Complete unit includes a RL56 Baffle-Trim LED Module and a 5" and 6" compatible housing (ordered separately). Optional accessory designer trim ring ordered separately.

RL56 900 Series

- 80 CRI**
RL560WH9827=5"/6" Retrofit Baffle - Trim LED Module, 80CRI, 2700K, Matte White
RL560WH9830=5"/6" Retrofit Baffle - Trim LED Module, 80CRI, 3000K, Matte White
RL560WH9835=5"/6" Retrofit Baffle - Trim LED Module, 80CRI, 3500K, Matte White
RL560WH9840=5"/6" Retrofit Baffle - Trim LED Module, 80CRI, 4000K, Matte White

- 90 CRI**
RL560WH9927=5"/6" Retrofit Baffle - Trim LED Module, 90CRI, 2700K, Matte White
RL560WH9930=5"/6" Retrofit Baffle - Trim LED Module, 90CRI, 3000K, Matte White
RL560WH9935=5"/6" Retrofit Baffle - Trim LED Module, 90CRI, 3500K, Matte White
RL560WH9940=5"/6" Retrofit Baffle - Trim LED Module, 90CRI, 4000K, Matte White

Accessory (Order Separately)

- RL56TRMSN**=5/6" Satin Nickel Trim Ring
RL56TRMTBZ=5/6" Tuscan Bronze Trim Ring
RL56TRMWH=5/6" White Paintable Trim Ring
OT400P=Oversize Flat White Metal Trim Ring 6" I.D. x 9-1/4" O.D. (ring slips behind RL560 ring, in stepped configuration)
OT403P=Oversize White Plastic Trim Ring 6" I.D. x 8" O.D. (ring slips behind RL560 ring, in stepped configuration)
TRM690WH=Oversize Matte White Metal Trim Ring. Designed for RL560 ring to inset into oversize ring for an even (non-stepped) trim surface
HE26LED=Replacement screw base adapter (one included with unit)



E26 Screw base adapter for retrofit (included)

Housing Compatibility

Compatible Halo LED Housings with LED luminaire connector (high-efficacy compliant)

HALO LED	Recessed Can Size	Catalog Number
	5"	H550ICAT, H550RICAT
	6"	H750ICAT, H750RICAT, H750T, H750RINTD010, H750TCP, H2750ICAT

Halo LED Retrofit Enclosures

HALO	6"	ML7BXRFK, ML7E26RFK
------	----	---------------------

Compatible Halo Incandescent E26 Screwbase Housings

HALO	5"	H5ICAT, H5RICAT, H5T, H5RT, H5TM, H25ICAT
	6"	H7ICAT, H7RICAT, H7ICT, H7RICT, H7ICATNB, H7ICTNB, H7T, H7RT, H7TNB, H7TCP, H7UICAT, H7UICAT, H27ICAT, H27RICAT, H27ICT, H27RICT, H27T, H27RT

Compatible All-Pro Incandescent E26 Screwbase Housings

ALL-PRO	5"	EI500AT, EI500RAT, ET500, ET500R
	6"	EI700AT, EI700RAT, EI700, EI700R, EI700ATNB, EI700NB, EI700U, EI700UAT, ET700, ET700R, EI2700AT, EI2700, EI2700R, ET2700, ET2700R

RL56 Series LED Retrofit is UL Classified for retrofit in the follow 5/6" recessed housings:

The RL Series LED light module - trim combination is cULus Listed or UL Classified for use with any 5"/6" diameter recessed housing constructed of steel or aluminum with an internal volume that exceeds 107.9 in³ in addition to those noted above.

LIGHTING FACTS

RL560WH9827
2700K Source

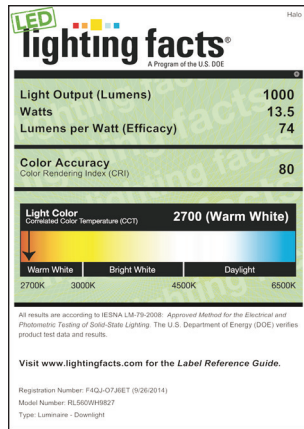

RL560WH9830
3000K Source

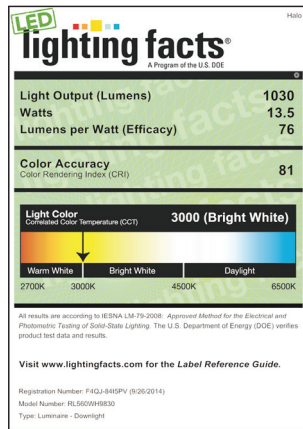

RL560WH9835
3500K Source

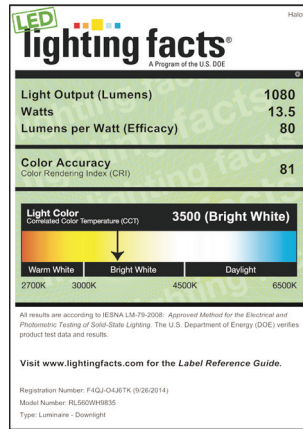

RL560WH9840
4000K Source

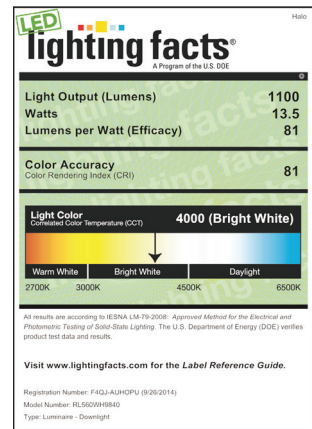

RL560WH9927
2700K Source

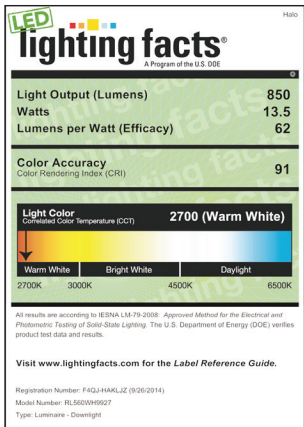

RL560WH9930
3000K Source

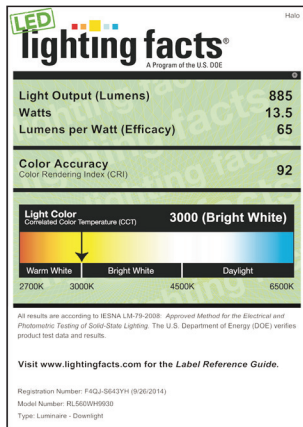

RL560WH9935
3500K Source

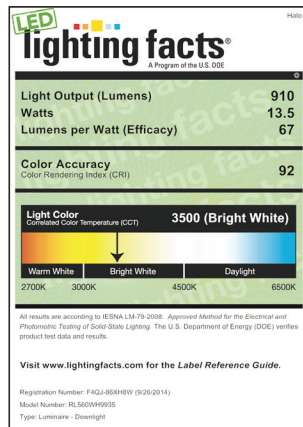

RL560WH9940
4000K Source

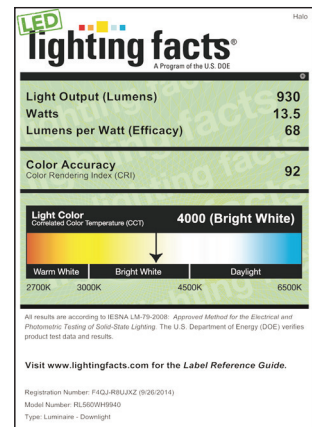

Product and Photometric Data

RL56 - 900 SERIES

Cat No.	CRI	CCT	Lumens	Power (W)	LPW
RL560WH9827	80	2700	1000	13.5	74
RL560WH9830	80	3000	1030	13.5	76
RL560WH9835	80	3500	1080	13.5	80
RL560WH9840	80	4000	1100	13.5	81
RL560WH9927	90	2700	850	13.5	63
RL560WH9930	90	3000	885	13.5	66
RL560WH9935	90	3500	910	13.5	67
RL560WH9940	90	4000	930	13.5	69

RL56-900 Series Photometric*

RL560WH9830		
Luminaire lumens		1030
Input watts		13.5
LER (LPW)		76
Spacing Criteria	0-180	1.28
	90-270	1.28
	Diagonal	1.36
Beam angle (degrees)		102
Field angle (degrees)		145
Zonal lumen	Lumens	% Lumens
0-30	334	32%
0-40	545	53%
0-60	908	88%
0-90	1030	100%

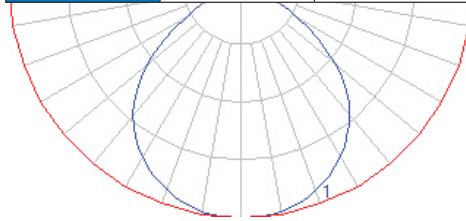

* Tested in accordance with IES LM63. Field results may vary.

Description

The Halo RL560 is a complete LED Baffle-Trim Module for 5" and 6" aperture recessed downlights; suitable for new construction, remodel and retrofit installation. The RL560 is cULus Listed for use with Halo and All-Pro, and is UL Classified for use with other compatible 5" and 6" housings. The RL560 with integral LED driver offers 120 volt dimming capability. The RL560 lens provides uniform illumination and wet location listing. Precision construction makes any housing AIR-TITE for added HVAC savings and code compliance. Compliant with NFPA 70, NEC section 410.16 (A)(1) and 410.16 (C)(3).

Catalog #		Type
Project		
Comments		Date
Prepared by		

Specification Features

MECHANICAL

Module - Trim

- Module construction includes LED, heat sink, reflector, lens, baffle and trim ring
- Regressed baffle
- Heat sink designed to conduct heat away from the LED keeping the junction temperatures below specified maximums, even when installed in insulated ceiling environments
- Designer trim finish options (sold separately)
 - White (Paintable) Trim Ring
 - Satin Nickel Trim Ring
 - Tuscan Bronze Trim Ring

Lens

- Regressed lens
- Impact-resistant polycarbonate
- Convex form for lamp-like appearance
- High lumen transmission
- Diffusing for even illumination

Mounting

- Integral torsion springs and Push-N-Twist clips offer two mounting options
 - Torsion springs are pre-installed and adjust to fit 5" or 6" compatible housings
 - Push-N-Twist universal installation clips are pre-installed and designed to fit 5" or 6" compatible housings

Housing Compatibility

See Housing Compatibility

LED

- Color Temperature (CCT)* Options: 2700K, 3000K, 3500K, and 4000K
- CRI options: 80 and 90†
 - 90 CRI can be used for California Title 24 compliance/certified to Title 20
 - 80 CRI can be used to comply with California Title 24 Non-Residential Lighting Controls requirements as an LED luminaire

LED Chromaticity

- A tight chromaticity specification ensures LED color uniformity, sustainable Color Rendering Index (CRI) and Correlated Color Temperature (CCT) over the useful life of the LED
- LED chromaticity of 3 SDCM exceeds ENERGY STAR® color standards per ANSI C78.377-2008
- 90 CRI model features high color performance with R9 greater than 50
- Every Halo LED is quality tested, measured, and serialized in a permanent record to register lumens, wattage, CRI and CCT
- Halo LED serialized testing and measurement ensures color and lumen consistency on a per-unit basis, and validates long-term product consistency over time

ELECTRICAL

Power Connections

- LED connector is a non-screw base luminaire disconnect offering easy installation with the matching Halo 5" and 6" LED housings
- LED Connector meets California Title-24 high efficacy luminaire requirement for a non-screw base socket, and where required to qualify as a high efficacy luminaire
- The included E26 medium screw-base Edison adapter provides easy retrofit of incandescent housings (see Housing Compatibility)

Ground Connection

Separate grounding cable included on the module for attachment to the housing during installation.

LED Driver

- Dimmable driver is a 120 Volt, high efficiency, electronic power supply providing DC power to the LED
- Driver meets FCC EMI/RFI Consumer Level limits for use in residential and commercial installations

- Driver features high power factor, low THD, and has integral thermal protection in the event of over temperature or internal failure

Dimming

- Designed for continuous dimming capability to nominally 5% with many 120V Leading Edge (LE) and Trailing Edge (TE) Phase Control dimmers. (Dimmers with low end trim adjustment offer greater assurance of achieving 5% level.)
- Consult dimmer manufacturer for compatibility and conditions of use

Note: some dimmers require a neutral in the wallbox.

Warranty

Cooper Lighting provides a five year limited warranty on RL56 LED.

Compliance Labels

- UL/cUL Listed 1598 Luminaire (with listed housings)
- UL Classified (with other housings - see Housing Compatibility)
- UL/cUL Listed for Damp Location
- UL/cUL Listed for Wet Location – Shower Applications
- IP56 Ingress Protection rated
- May be installed in housings in direct contact with insulation** and combustible material

Compliance

- Airtight certified per ASTM E283 (not exceeding 2.0 CFM under 75 Pascals pressure difference)
- 90 CRI: Can be used to comply with California Title 24 High Efficacy requirements. Certified to California Title 20 Appliance Efficiency Database.*
- 80 CRI: Can be used to comply with California Title 24 Non-Residential Lighting Controls requirements as an LED luminaire
- Can be used for International Energy Conservation Code (IECC) high efficiency luminaire compliance



RL560WH9†

White

**900 Series
5/6-Inch LED
Recessed Retrofit
Module-Trim**

**80CRI
2700K, 3000K,
3500K, 4000K**

**90CRI
2700K, 3000K,
3500K, 4000K**

**FOR USE IN
INSULATED CEILING
AND NON- INSULATED
CEILING RATED
HOUSINGS**

**HIGH EFFICACY LED
WITH INTEGRAL
DRIVER - DIMMABLE**

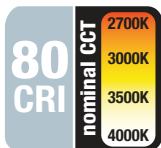

Refer to ENERGY STAR® Certified Products List.

Can be used to comply with California Title 24 Non-Residential Lighting Controls requirements as a LED Luminaire.

* Refer to ENERGY STAR® Certified Products List and CEC (T20) Appliance Database for listings.

** Not for use with housings in direct contact with spray foam insulation.

† See ordering information table for available models.



Refer to ENERGY STAR® Certified Products List.

Can be used to comply with California Title 24 High Efficacy requirements.

Certified to California Title 20 Appliance Efficiency Database.

Specification Features (continued)

- Can be used for Washington State Energy Code compliance
- ENERGY STAR® Certified luminaire - consult ENERGY STAR® Certified Product List*
- EMI/RFI per FCC 47CFR Part 15 Class B Consumer limits, suitable for use in residential and commercial installations
- Contains no mercury or lead and RoHS compliant
- Photometric testing in accordance with IES LM-79
- Lumen maintenance projections in accordance with IES LM-80 and TM-21
- Suitable for use in closets. Compliant with NFPA 70, NEC Sec. 410.16 (A)(1) and 410.16 (C)(3).

RL56 Dimensions

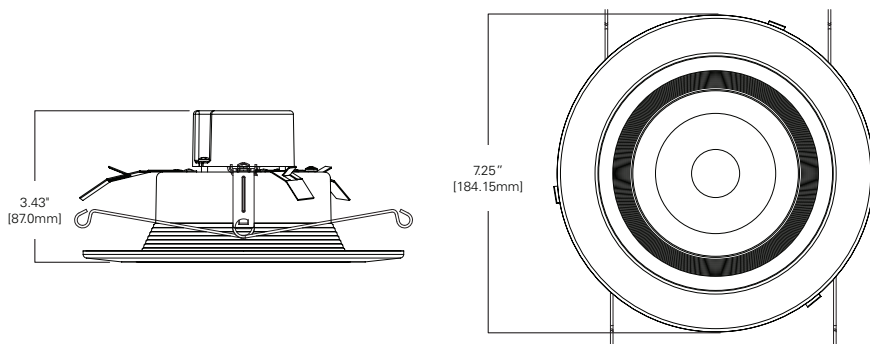

Energy Data

RL56 Series (Values at non-dimming line voltage)

Minimum Starting Temp: -30°C (-22°F)
EMI/RFI: FCC Title 47 CFR, Part 15, Class B (Consumer)
Sound Rating: Class A
Input Voltage: 120V
Power Factor: >0.90
Input Frequency: 60Hz
THD: <20%
Input Power: 13.5W
Input Current: 0.15A
Maximum IC (Insulated Ceiling) Ambient Continuous Operating Temperature: 25°C (77°F)
Maximum Non-IC Ambient Continuous Operating Temperature 40°C (104°F)

Designer Trim Dimensions

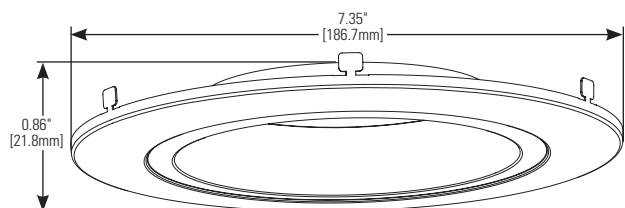

RL56TRMWH
White (Paintable)

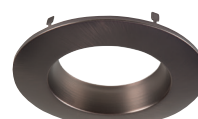

RL56TRMTBZ
Tuscan Bronze

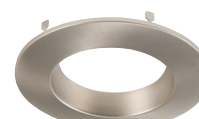

RL56TRMSN
Satin Nickel

Performance Data

Catalog #	CRI	Lumens	LPW	Watts	CCT
RL560WH9827	80	1000	74	13.5	2700K
RL560WH9830	80	1030	76	13.5	3000K
RL560WH9835	80	1080	80	13.5	3500K
RL560WH9840	80	1100	81	13.5	4000K
RL560WH9927	90	850	63	13.5	2700K
RL560WH9930	90	885	66	13.5	3000K
RL560WH9935	90	910	67	13.5	3500K
RL560WH9940	90	930	69	13.5	4000K

Ordering Information

Sample Number: **RL560WH9827-RL56TRMSN**

Complete unit includes a RL56 Baffle-Trim LED Module and a 5" and 6" compatible housing (ordered separately). Optional accessory designer trim ring ordered separately.

RL56 900 Series

- 80 CRI**
RL560WH9827=5"/6" Retrofit Baffle - Trim LED Module, 80CRI, 2700K, Matte White
RL560WH9830=5"/6" Retrofit Baffle - Trim LED Module, 80CRI, 3000K, Matte White
RL560WH9835=5"/6" Retrofit Baffle - Trim LED Module, 80CRI, 3500K, Matte White
RL560WH9840=5"/6" Retrofit Baffle - Trim LED Module, 80CRI, 4000K, Matte White

- 90 CRI**
RL560WH9927=5"/6" Retrofit Baffle - Trim LED Module, 90CRI, 2700K, Matte White
RL560WH9930=5"/6" Retrofit Baffle - Trim LED Module, 90CRI, 3000K, Matte White
RL560WH9935=5"/6" Retrofit Baffle - Trim LED Module, 90CRI, 3500K, Matte White
RL560WH9940=5"/6" Retrofit Baffle - Trim LED Module, 90CRI, 4000K, Matte White

Accessory (Order Separately)

- RL56TRMSN**=5/6" Satin Nickel Trim Ring
RL56TRMTBZ=5/6" Tuscan Bronze Trim Ring
RL56TRMWH=5/6" White Paintable Trim Ring
OT400P=Oversize Flat White Metal Trim Ring 6" I.D. x 9-1/4" O.D. (ring slips behind RL560 ring, in stepped configuration)
OT403P=Oversize White Plastic Trim Ring 6" I.D. x 8" O.D. (ring slips behind RL560 ring, in stepped configuration)
TRM690WH=Oversize Matte White Metal Trim Ring. Designed for RL560 ring to inset into oversize ring for an even (non-stepped) trim surface
HE26LED=Replacement screw base adapter (one included with unit)



E26 Screw base adapter for retrofit (included)

Housing Compatibility

Compatible Halo LED Housings with LED luminaire connector (high-efficacy compliant)

HALO LED	Recessed Can Size	Catalog Number
	5"	H550ICAT, H550RICAT
	6"	H750ICAT, H750RICAT, H750T, H750RINTD010, H750TCP, H2750ICAT

Halo LED Retrofit Enclosures

HALO	6"	ML7BXRFK, ML7E26RFK
------	----	---------------------

Compatible Halo Incandescent E26 Screwbase Housings

HALO	5"	H5ICAT, H5RICAT, H5T, H5RT, H5TM, H25ICAT
	6"	H7ICAT, H7RICAT, H7ICT, H7RICT, H7ICATNB, H7ICTNB, H7T, H7RT, H7TNB, H7TCP, H7UICAT, H7UICAT, H27ICAT, H27RICAT, H27ICT, H27RICT, H27T, H27RT

Compatible All-Pro Incandescent E26 Screwbase Housings

ALL-PRO	5"	EI500AT, EI500RAT, ET500, ET500R
	6"	EI700AT, EI700RAT, EI700, EI700R, EI700ATNB, EI700NB, EI700U, EI700UAT, ET700, ET700R, EI2700AT, EI2700, EI2700R, ET2700, ET2700R

RL56 Series LED Retrofit is UL Classified for retrofit in the follow 5/6" recessed housings:

The RL Series LED light module - trim combination is cULus Listed or UL Classified for use with any 5"/6" diameter recessed housing constructed of steel or aluminum with an internal volume that exceeds 107.9 in³ in addition to those noted above.

LIGHTING FACTS

RL560WH9827
2700K Source

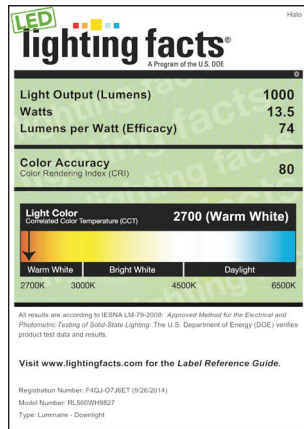

RL560WH9830
3000K Source

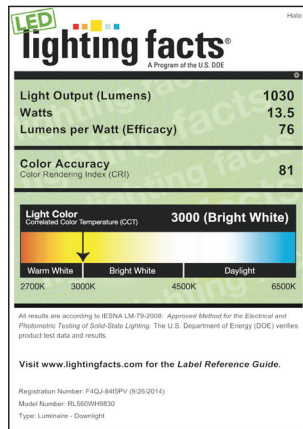

RL560WH9835
3500K Source

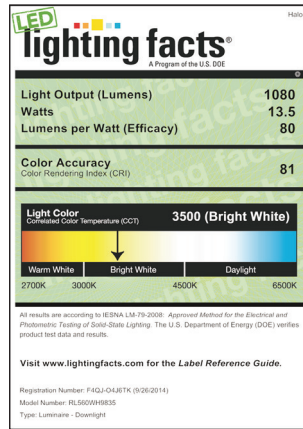

RL560WH9840
4000K Source

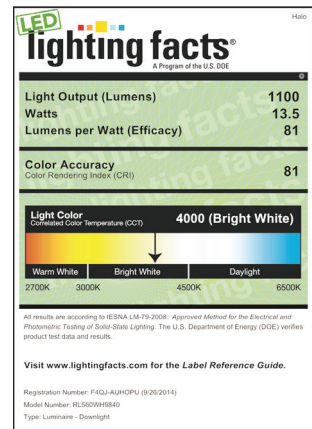

RL560WH9927
2700K Source

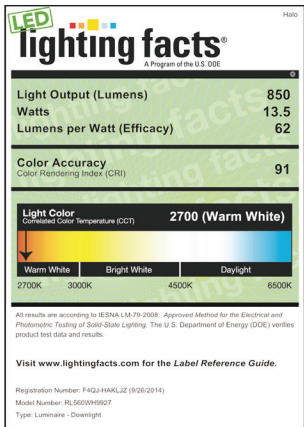

RL560WH9930
3000K Source

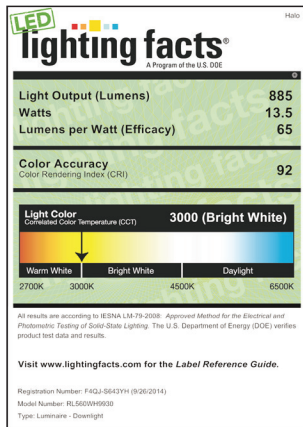

RL560WH9935
3500K Source

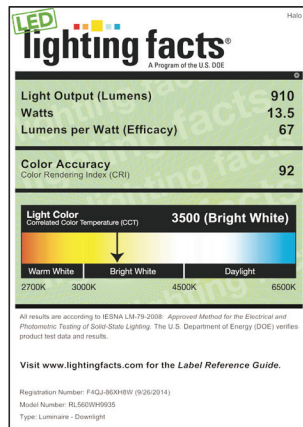

RL560WH9940
4000K Source

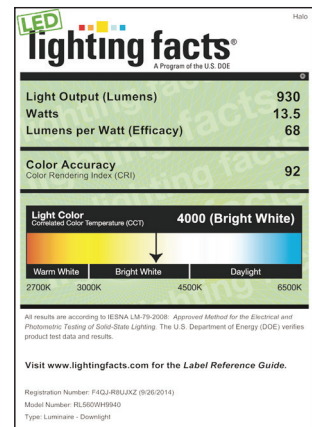

Product and Photometric Data

RL56 - 900 SERIES

Cat No.	CRI	CCT	Lumens	Power (W)	LPW
RL560WH9827	80	2700	1000	13.5	74
RL560WH9830	80	3000	1030	13.5	76
RL560WH9835	80	3500	1080	13.5	80
RL560WH9840	80	4000	1100	13.5	81
RL560WH9927	90	2700	850	13.5	63
RL560WH9930	90	3000	885	13.5	66
RL560WH9935	90	3500	910	13.5	67
RL560WH9940	90	4000	930	13.5	69

RL56-900 Series Photometric*

RL560WH9830		
Luminaire lumens		1030
Input watts		13.5
LER (LPW)		76
Spacing Criteria	0-180	1.28
	90-270	1.28
	Diagonal	1.36
Beam angle (degrees)		102
Field angle (degrees)		145
Zonal lumen	Lumens	% Lumens
0-30	334	32%
0-40	545	53%
0-60	908	88%
0-90	1030	100%

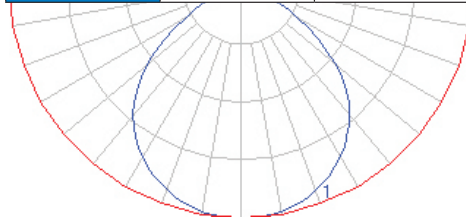

* Tested in accordance with IES LM63. Field results may vary.