

MAXI-BEAM[®] Sensor Heads



Banner MAXI-BEAM[®] sensors are highly versatile, self-contained, modularized photoelectric sensing controls that are ideally suited to industrial environments. The basic MAXI-BEAM is an ON/OFF switch consisting of three modules (sensor head, power block, and wiring base) and a unique, patented, rotatable "programming ring" that enables you to program your choice of "light" or "dark" operate mode, sensing range, and response time.

MAXI-BEAM sensor heads have an easily-accessible multi-turn SENSITIVITY control for precise adjustment of system gain. Interchangeable sensor heads are rotatable in 90-degree increments and are available in retroreflective, diffuse, opposed, convergent, fixed-field proximity, and fiberoptic sensing modes. Each sensor head also includes Banner's exclusive, patented AID[™] circuit (Alignment Indicating Device*), which features an LED alignment indicator that lights whenever the sensor "sees" its own modulated light source, and pulses at a rate proportional to the strength of the received light signal.

A wide selection of MAXI-BEAM power block modules is available to interface the sensor head to the circuit to be controlled. The plug-in design of the wiring base enables easy exchange of the entire sensing electronics without disturbing field wiring.

Optional customer-installable logic modules easily convert the basic ON/OFF MAXI-BEAM into either a one-shot or delay logic function control, with several programmable timing ranges for each function.

MAXI-BEAM sensors are ruggedly constructed of molded VALOX[®] to NEMA standards 1, 3, 4, 12, and 13, and have interchangeable molded acrylic lenses. Modules simply snap and bolt together, with no interwiring necessary. Module interfaces are o-ring and quad-ring sealed for the ultimate in dust, dirt, and moisture resistance.

To order a MAXI-BEAM, follow these steps:

- 1) Select a sensor head module,
- 2) Select a power block module,
- 3) Select a wiring base,
- 4) Select a logic module (if needed),
- 5) Select accessories as needed (see Banner product catalog).

Sensor Head Modules (described in this data sheet, P/N 03416)

RSBE & RSBR	opposed mode	range to 300'
RSBESR & RSBRSR	opposed mode (short range; narrow beam)	range to 15'
RSBLV	retroreflective mode	range to 30'
RSBLVAG	retroreflective mode (anti-glare filter)	range to 15'
RSBD	long range diffuse proximity mode	range to 5'
RSBDSR	short-range diffuse proximity mode	range to 30"
RSBCV	visible red convergent mode, focus at:	1.5"
RSBC	infrared convergent mode, focus at:	1.5"
RSBF	infrared fiber optic; for glass fibers	
RSBFV	visible red fiber optic; for glass fibers	
RSBEF & RSBRF	infrared fiber optic opposed mode; for glass fibers	
RSBFP	visible red fiber optic; for plastic fibers	
RSBFF50, RSBFF100	fixed-field proximity; sharp far-limit cutoff at 50 or 100 mm	

Power Block Modules (see data sheet P/N 03418)

RPBT	10-30V dc; one sinking and one sourcing solid-state output
RPBT-1	10-30V dc; for use with RSBE, ESR, EF emitters (no output circuit)
RPBTLM	10-30V dc low-profile power block (requires no RWB4 wiring base)
RPBA	105-130V ac (50/60Hz); SPST solid-state output
RPBA-1	105-130V ac (50/60Hz); for use with emitter (no output circuit)
R2PBA	2-wire operation; 105-130V ac (50/60Hz); SPST solid-state output
RPBB	210-250V ac (50/60Hz); SPST solid-state output
RPBB-1	210-250V ac (50/60Hz); use with emitter (no output circuit)
R2PBB	2-wire operation; 210-250V ac (50/60Hz); SPST solid-state output
RPBU	12-250V ac or 12-30V dc; SPST solid-state output (ac or dc)
RPBR	12-250V ac (50/60Hz) or 12-30V dc; SPST E/M relay output
RPBR2	12-250V ac (50/60Hz) or 12-30V dc; SPDT E/M relay output

Wiring Base (see data sheet P/N 03418)

RWB4 4-terminal wiring base for all models (except RPBTLM)

Logic Modules (see data sheet P/N 03417)

RLM5 ON/OFF delay (both functions adjustable up to 15 seconds)
RLM8 DELAYED ONE-SHOT (delay and pulse adjustable up to 15 seconds)

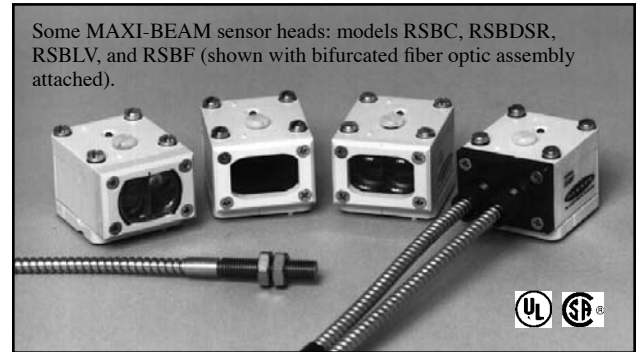

General Specifications

Construction: Reinforced molded VALOX[®] housing, molded acrylic lenses, o-ring and quad-ring gasketed components. Electronic components are fully epoxy encapsulated. NEMA 1, 3, 4, 12, and 13.

Operating Temperature: -40 to +70°C (-40 to +158°F).

Sensitivity Adjustment: Easily accessible, located on top of the sensor head beneath a watertight gasketed screw-cover. 15-turn clutched control; rotate clockwise to increase sensitivity.

Alignment Indicator: Red LED on top of sensor head. Banner's exclusive AID[™] circuit (*US patent no. 4356393) lights the LED whenever the sensor sees its own modulated light source, and pulses the LED at a rate proportional to the strength of the received light signal.

False Pulse Suppression on Power-up: 100ms delay on power-up.

Response Time and Repeatability: Specifications to follow in individual product descriptions are independent of signal strength.

VALOX[®] is a registered trademark of General Electric Co.

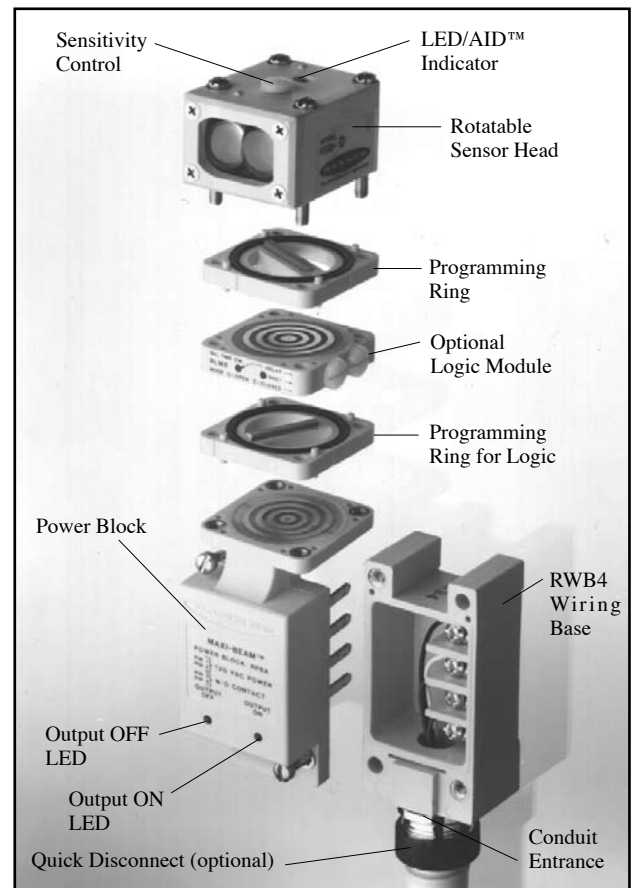

MAXI-BEAM Sensor Heads

Sensing Mode

Models

Excess Gain

Beam Pattern



RSBE & RSBR

Range: 300 feet (90 m) in "HP" (high power) and 2W (2 wire) modes
Beam: infrared, 880nm; visible red tracer beam
Effective Beam: 0.5" dia.
Response:
 HP, 2W mode: 10ms on/5 off
 HS mode: 1ms on/0.5 off
 SP mode: 0.3ms on/off
Repeatability: HP, 2W= 1.4ms; HS = 0.1ms; SP = 0.04ms

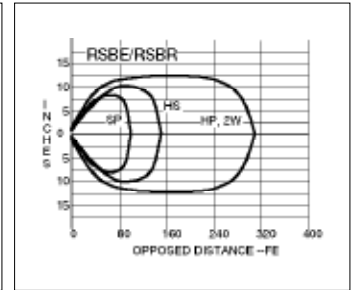
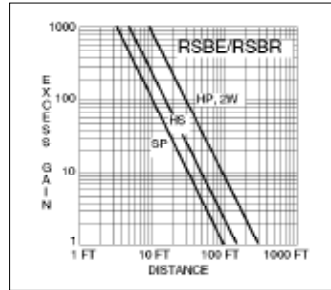

OPPOSED Mode



RSBESR & RSBRSR

Range: 15 feet (4.5m) in "HP" (high power) and 2W (2 wire) modes
Beam: infrared, 880nm
Response:
 HP, 2W modes: 10ms on/5 off
 HS mode: 1ms on/0.5 off
 SP mode: 0.3ms on/off
Repeatability: HP, 2W= 1.4ms; HS = 0.1ms; SP = 0.04ms

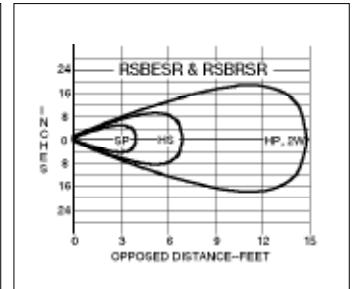
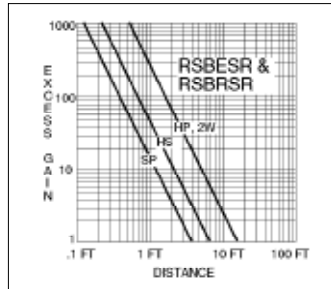

MAXI-BEAM emitters have a visible red "tracer beam". This beam is non-active, and is used as a means of visual alignment during installation. A retroreflector temporarily attached to the receiver lens provides an effective target for the tracer beam during alignment. The narrow beam of the RSBESR/RSBRSR pair is ideal for sensing small parts (effective beam diameter is 0.14 inch).



RSBEF & RSBRF

Range: see excess gain curves
Beam: infrared, 880nm.
Response:
 HP, 2W modes: 10ms
 HS mode: 1ms
 SP mode: 0.3ms on/off
Repeatability: HP, 2W= 3.3ms; HS = 0.3ms; SP = 0.1ms

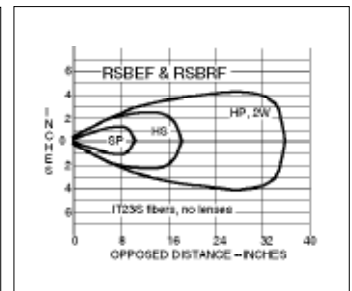
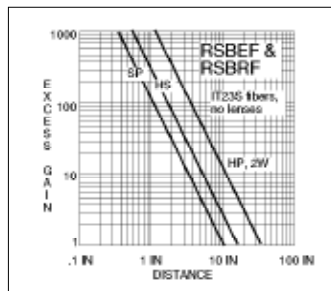

OPPOSED FIBER OPTIC Mode (glass fibers)

This sensor pair is designed for opposed mode operation using Banner glass fiber optics. Maximum range (HP mode) using L9 lenses is 12 feet. Maximum range using L16F lenses is 50 feet.



RSBLV

Range: 6 inches to 30 feet (9 m) in all program modes
Beam: visible red, 650nm
Response:
 HP, 2W, SP modes: 4ms
 HS mode: 1ms
Repeatability:
 HP, 2W, SP = 1.3ms; HS = 0.3ms

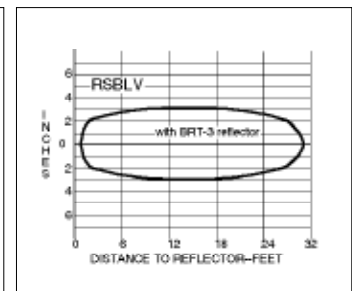
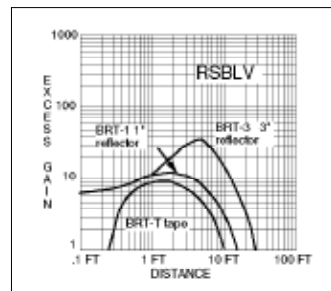

RETROREFLECTIVE Mode



RSBLVAG (anti-glare filter)

Range: 1 to 15 feet (4.5 m) in all program modes
Beam: visible red, 650nm; with polarizing filter
Response:
 HP, 2W, SP modes: 4ms
 HS mode: 1ms
Repeatability: HP, 2W, SP = 1.3ms; HS = 0.3ms

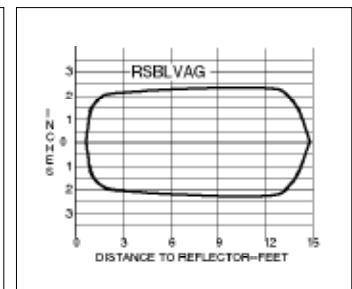
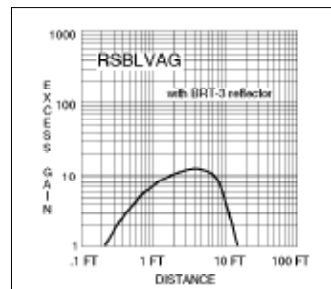

MAXI-BEAM Sensor Heads

Sensing Mode

Models

Excess Gain

Beam Pattern



RSBD

Range: 5 feet (1.5 m) in HP and 2W modes

Beam: infrared, 880nm

Response:

HP, 2W modes: 10ms

HS mode: 1ms

SP mode: 0.3ms

Repeatability: HP, 2W= 3.3ms; **HS =** 0.3ms; **SP =** 0.1ms

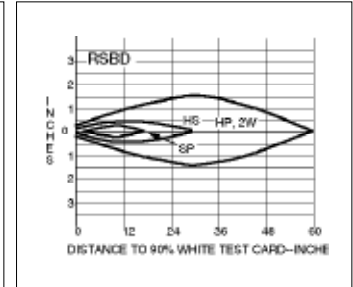
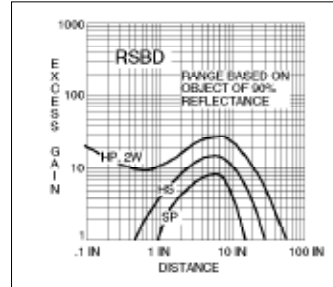

DIFFUSE Mode



RSBDSR

(short range)

Range: 30 inches (76cm) in HP and 2W modes

Beam: infrared, 880nm

Response:

HP, 2W modes: 10ms

HS mode: 1ms

SP mode: 0.3ms

Repeatability: HP, 2W= 3.3ms; **HS =** 0.3ms; **SP =** 0.1ms

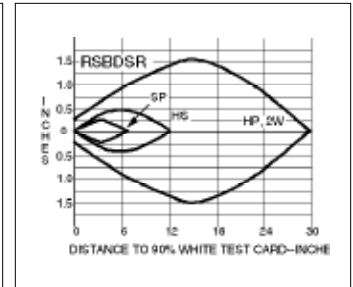
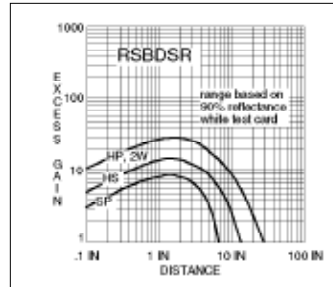

RSBC

Focus at 1.5 in. (38mm)

Beam: infrared, 940nm

Response:

HP, 2W modes: 10ms

HS mode: 1ms

SP mode: 0.3ms

Repeatability: HP, 2W= 3.3ms; **HS =** 0.3ms; **SP =** 0.1ms

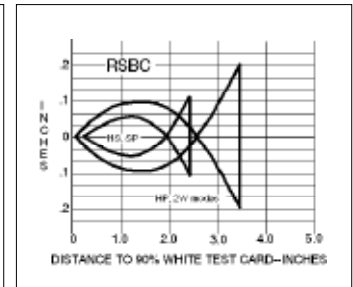
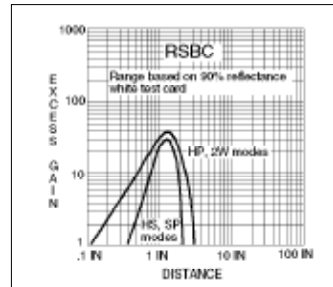

CONVERGENT Mode



RSBVCV

Focus at 1.5 in. (38mm); performance equal in all program modes.

Beam: visible red, 650nm.

Response:

HP, 2W, SP modes: 4ms

HS mode: 1ms

Repeatability: HP, 2W, SP= 1.3ms; **HS =** 0.3ms

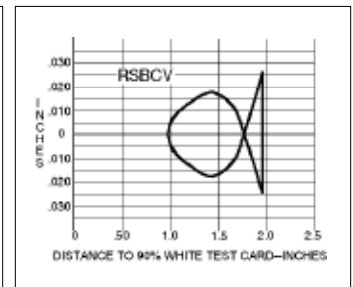
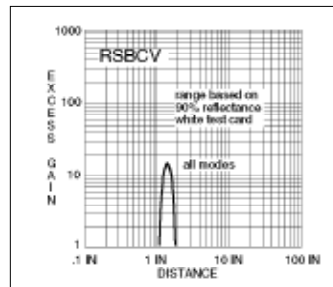

Powerful visible red beam with precise .06" diameter sensing spot. Useful in many high-contrast color registration applications.

FIXED-FIELD Mode



RSBFF models

Far limit cutoff at: 50mm (model RSBFF50) or 100mm (model RSBFF100)

Beam: infrared, 880nm.

Response:

HP mode: 10ms

Repeatability: HP mode: 3.3ms

Fixed-field sensor heads have an emitter element and two differently-aimed receiver elements. This creates a high-gain sensing field able to detect objects of low reflectivity, and a sharp far-limit sensing cutoff of 50mm (2 inches) or 100mm (4 inches) which ignores backgrounds beyond cutoff.

These sensors are ideal for detecting a part or surface that is only a fraction of an inch in front of another surface.

RSBFFs may not be used with 2-wire power blocks.

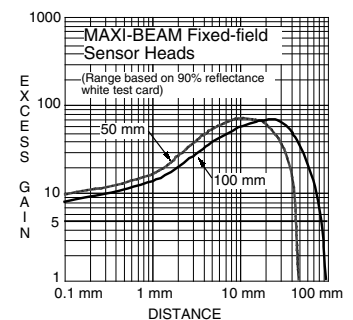

MAXI-BEAM Sensor Heads

Sensing Mode

Models

Excess Gain

Beam Pattern

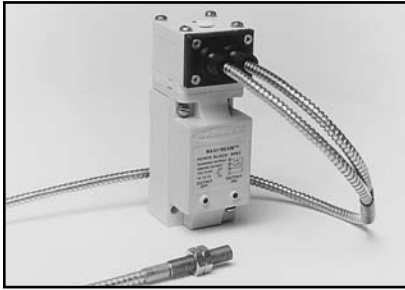

RSBF

Range: see excess gain curves

Beam: infrared, 880nm

Response:

HP, 2W modes: 10ms

HS mode: 1ms

SP mode: 0.3ms

Repeatability:

HP, 2W = 3.3ms;

HS = 0.3ms;

SP = 0.1ms

FIBER OPTIC Mode

(glass fibers)

OPPOSED MODE

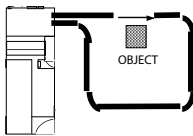

RETRO MODE

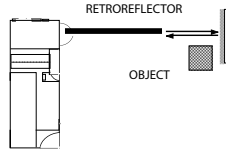

DIFFUSE MODE

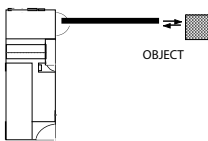

NOTE: if the retroreflective sensing mode is used in conjunction with the HP or 2W program mode, the GAIN control must be reduced from the factory setting in order to avoid optical feedback from the lens assembly.

For information on the complete line of Banner glass fiber optics, see Banner product catalog.

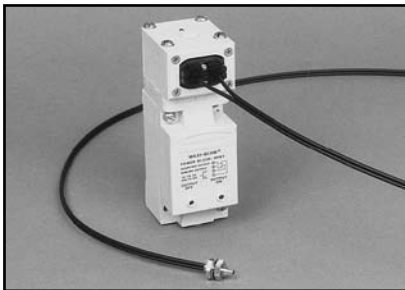
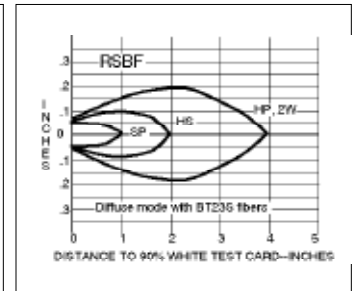
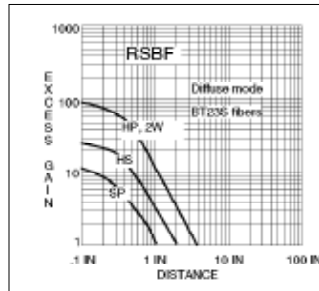
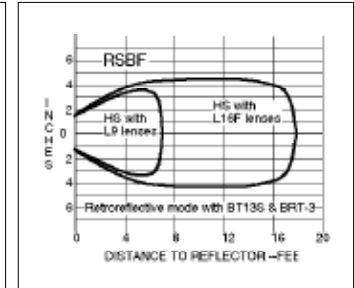
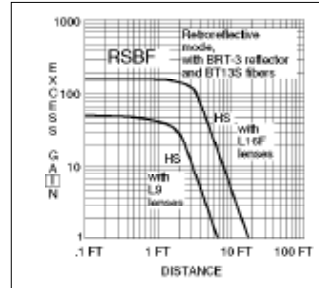
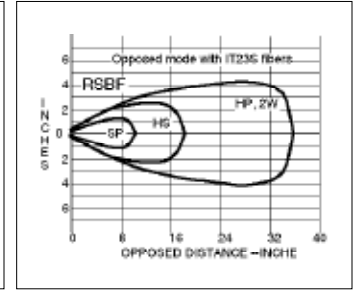
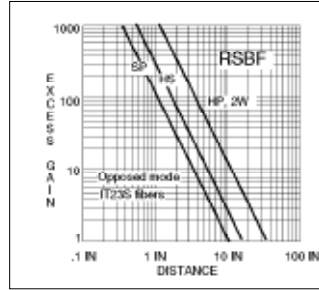

RSBFP

Range: see excess gain curves

Beam: visible red, 650nm.

Response:

HS mode only: 1ms on/off

Repeatability:

HS = 0.3ms

FIBER OPTIC Mode

OPPOSED MODE

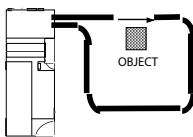

DIFFUSE MODE

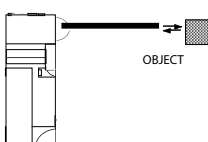

The model RSBFP will function only when programmed for the "HS" response mode.

The model RSBFP will not operate with 2-wire power blocks (models R2PBA and R2PBB).

For information on the complete line of Banner plastic fiber optics, see Banner product catalog.

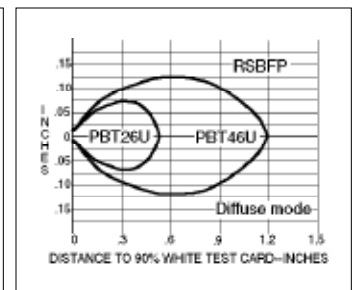
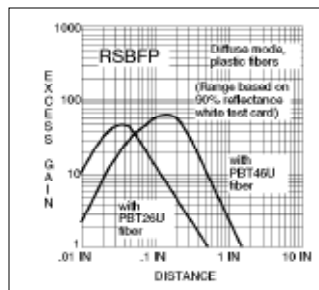
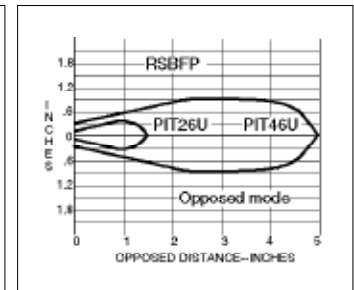
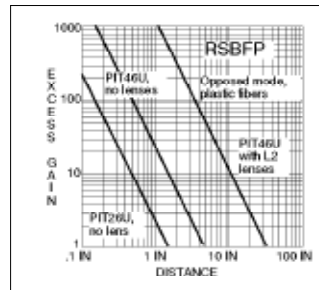

Model RSBFP is a visible-light sensor head designed for use with plastic fiber optics. It is compatible with all standard Banner plastic fiber optic assemblies (see Banner product catalog). In order to function properly, the RSBFP must be programmed for the "HS" response mode. The RSBFP is not for use with glass fiber optics (instead use model RSBF or RSBFV).

MAXI-BEAM Sensor Heads

Sensing Mode

Models

Excess Gain

Beam Pattern

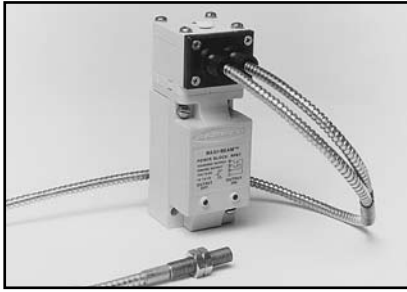

RSBFV

Range: see excess gain curves
 Beam: visible red, 650nm.
 Response:
 HS mode only, 1ms on/off
 Repeatability:
 HS = 0.3ms

The model RSBFV will function only when programmed for the "HS" response mode.

The model RSBFV will not operate with 2-wire power blocks (models R2PBA and R2PBB).

Model RSBFV is a visible-light sensor head designed for use with glass fiber optics. It is compatible with all standard Banner glass fiber optic assemblies (see Banner product catalog). In order to function properly, the RSBFV must be programmed for the "HS" response mode. The RSBFV is not for use with plastic fiber optics (instead use RSBFP).

FIBER OPTIC Mode (glass fibers)

OPPOSED MODE

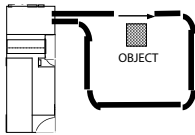

RETRO MODE

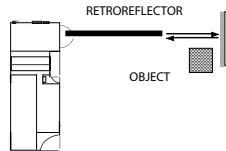

DIFFUSE MODE

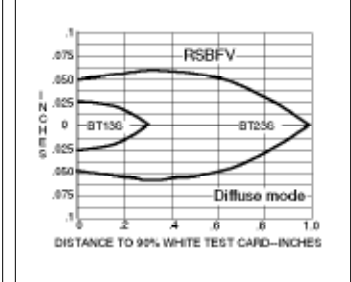
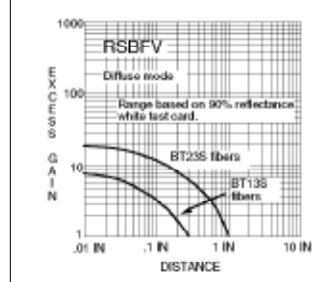
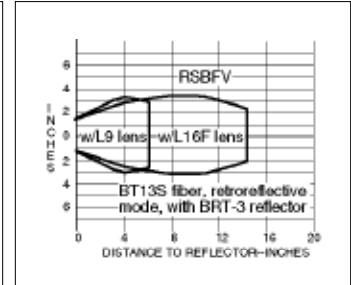
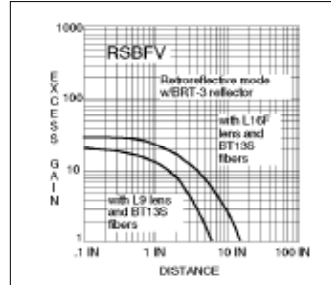
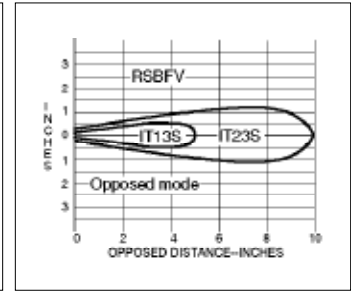
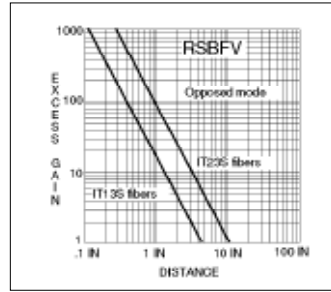
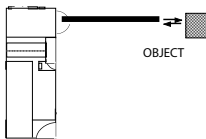

Programming the MAXI-BEAM Sensor Head

MAXI-BEAM sensor heads may be programmed for sensor response time (and range) and for LIGHT/DARK operate. Each sensor head is supplied with a programming ring which attaches below the the sensor head by a system of pegs. There are four programming notches around the perimeter of the ring. To program the sensor head, simply find the notch which will line up with the desired program combination (see diagram, right). NOTE: the programming ring may have to be turned upside-down in order to line up the notch with the program. If LIGHT OPERATE is selected, the MAXI-BEAM output will energize on a dark-to-light transition. If DARK OPERATE is selected, the MAXI BEAM output will energize on a light-to-dark transition. In the illustration, the MAXI-BEAM is set for high speed (HS) operation in the LIGHT OPERATE output state. See the information about each individual sensor head for the response time and range associated with each setting (HP, 2W, HS, SP). NOTE: when programming the RSBE, RSBSER, or RSBEF emitter, select the mode which is programmed for the receiver. EXCEPTION: if the receiver is programmed for the 2-wire (2W) mode, select high power (HP) on the emitter.

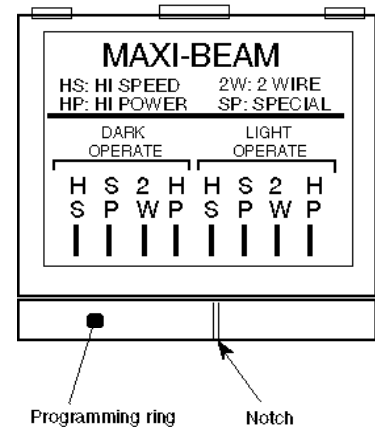

WARNING

MAXI-BEAM photoelectric presence sensors do NOT include the self-checking redundant circuitry necessary to allow their use in personnel safety applications. A sensor failure or malfunction can result in either an energized or de-energized sensor output condition. Never use these products as sensing devices for personnel protection. Their use as safety devices may create an unsafe condition which could lead to serious injury or death. Only MACHINE- GUARD and PERIMETER- GUARD Systems, and other systems so designated, are designed to meet OSHA and ANSI machine safety standards for point- of -operation guarding devices. No other Banner sensors or controls are designed to meet these standards, and they must NOT be used as sensing devices for personnel protection.

Dimension Drawing

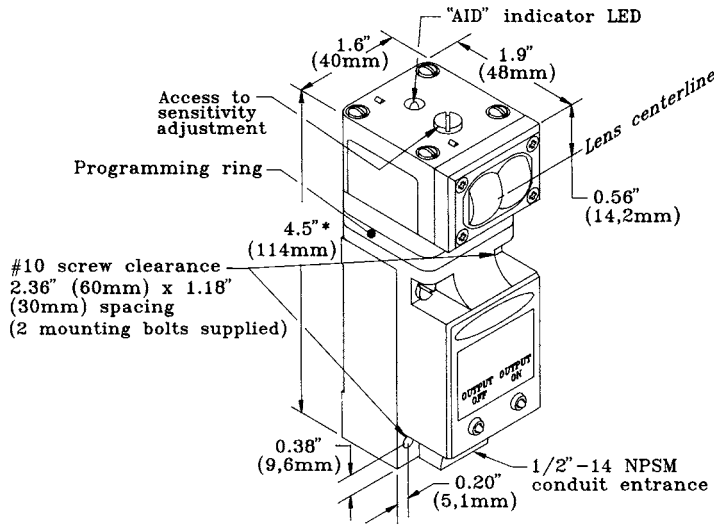

* 5.0" (127mm) with logic module and second programming ring installed.

Functional Schematic, MAXI-BEAM Sensor Heads

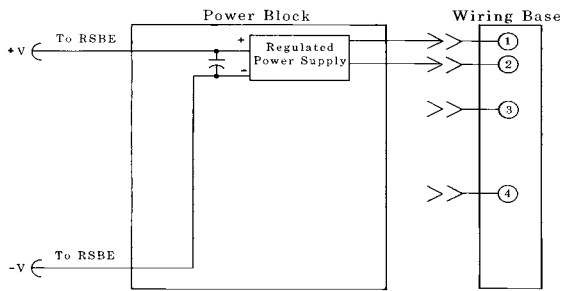

Composite Functional Schematic, MAXI-BEAM Sensors

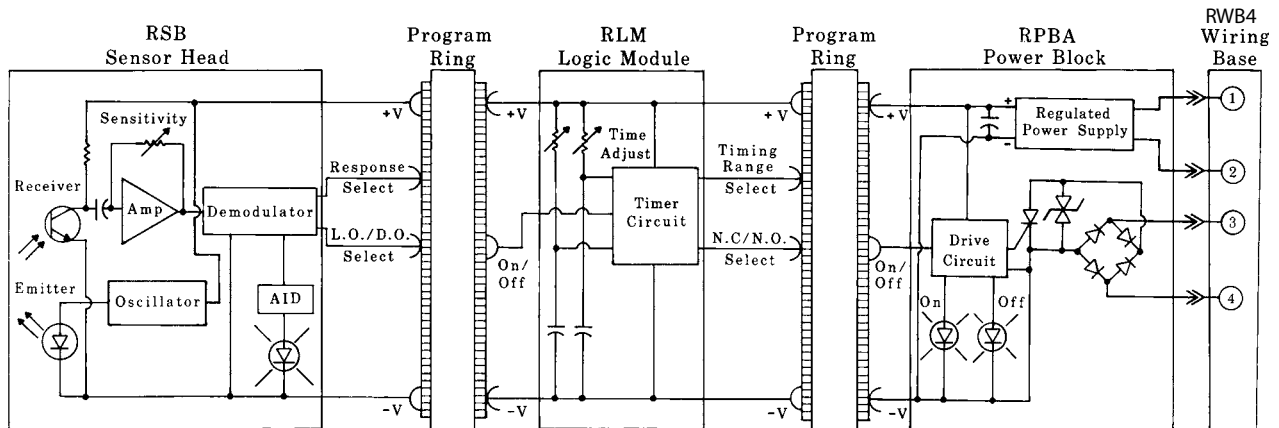

Banner Engineering Corp Limited Warranty

Banner Engineering Corp. warrants its products to be free from defects in material and workmanship for one year following the date of shipment. Banner Engineering Corp. will repair or replace, free of charge, any product of its manufacture which, at the time it is returned to the factory, is found to have been defective during the warranty period. This warranty does not cover damage or liability for misuse, abuse, or the improper application or installation of the Banner product.

THIS LIMITED WARRANTY IS EXCLUSIVE AND IN LIEU OF ALL OTHER WARRANTIES WHETHER EXPRESS OR IMPLIED (INCLUDING, WITHOUT LIMITATION, ANY WARRANTY OF MERCHANTABILITY OR FITNESS FOR A PARTICULAR PURPOSE), AND WHETHER ARISING UNDER COURSE OF PERFORMANCE, COURSE OF DEALING OR TRADE USAGE.

This Warranty is exclusive and limited to repair or, at the discretion of Banner Engineering Corp., replacement. **IN NO EVENT SHALL BANNER ENGINEERING CORP. BE LIABLE TO BUYER OR ANY OTHER PERSON OR ENTITY FOR ANY EXTRA COSTS, EXPENSES, LOSSES, LOSS OF PROFITS, OR ANY INCIDENTAL, CONSEQUENTIAL OR SPECIAL DAMAGES RESULTING FROM ANY PRODUCT DEFECT OR FROM THE USE OR INABILITY TO USE THE PRODUCT, WHETHER ARISING IN CONTRACT OR WARRANTY, STATUTE, TORT, STRICT LIABILITY, NEGLIGENCE, OR OTHERWISE.**

Banner Engineering Corp. reserves the right to change, modify or improve the design of the product without assuming any obligations or liabilities relating to any product previously manufactured by Banner Engineering Corp.

MAXI-BEAM[®] Sensor Heads



Banner MAXI-BEAM[®] sensors are highly versatile, self-contained, modularized photoelectric sensing controls that are ideally suited to industrial environments. The basic MAXI-BEAM is an ON/OFF switch consisting of three modules (sensor head, power block, and wiring base) and a unique, patented, rotatable "programming ring" that enables you to program your choice of "light" or "dark" operate mode, sensing range, and response time.

MAXI-BEAM sensor heads have an easily-accessible multi-turn SENSITIVITY control for precise adjustment of system gain. Interchangeable sensor heads are rotatable in 90-degree increments and are available in retroreflective, diffuse, opposed, convergent, fixed-field proximity, and fiberoptic sensing modes. Each sensor head also includes Banner's exclusive, patented AID[™] circuit (Alignment Indicating Device*), which features an LED alignment indicator that lights whenever the sensor "sees" its own modulated light source, and pulses at a rate proportional to the strength of the received light signal.

A wide selection of MAXI-BEAM power block modules is available to interface the sensor head to the circuit to be controlled. The plug-in design of the wiring base enables easy exchange of the entire sensing electronics without disturbing field wiring.

Optional customer-installable logic modules easily convert the basic ON/OFF MAXI-BEAM into either a one-shot or delay logic function control, with several programmable timing ranges for each function.

MAXI-BEAM sensors are ruggedly constructed of molded VALOX[®] to NEMA standards 1, 3, 4, 12, and 13, and have interchangeable molded acrylic lenses. Modules simply snap and bolt together, with no interwiring necessary. Module interfaces are o-ring and quad-ring sealed for the ultimate in dust, dirt, and moisture resistance.

To order a MAXI-BEAM, follow these steps:

- 1) Select a sensor head module,
- 2) Select a power block module,
- 3) Select a wiring base,
- 4) Select a logic module (if needed),
- 5) Select accessories as needed (see Banner product catalog).

Sensor Head Modules (described in this data sheet, P/N 03416)

RSBE & RSBR	opposed mode	range to 300'
RSBESR & RSBRSR	opposed mode (short range; narrow beam)	range to 15'
RSBLV	retroreflective mode	range to 30'
RSBLVAG	retroreflective mode (anti-glare filter)	range to 15'
RSBD	long range diffuse proximity mode	range to 5'
RSBDSR	short-range diffuse proximity mode	range to 30"
RSBCV	visible red convergent mode, focus at:	1.5"
RSBC	infrared convergent mode, focus at:	1.5"
RSBF	infrared fiber optic; for glass fibers	
RSBFV	visible red fiber optic; for glass fibers	
RSBEF & RSBRF	infrared fiber optic opposed mode; for glass fibers	
RSBFP	visible red fiber optic; for plastic fibers	
RSBFF50, RSBFF100	fixed-field proximity; sharp far-limit cutoff at 50 or 100 mm	

Power Block Modules (see data sheet P/N 03418)

RPBT	10-30V dc; one sinking and one sourcing solid-state output
RPBT-1	10-30V dc; for use with RSBE, ESR, EF emitters (no output circuit)
RPBTLM	10-30V dc low-profile power block (requires no RWB4 wiring base)
RPBA	105-130V ac (50/60Hz); SPST solid-state output
RPBA-1	105-130V ac (50/60Hz); for use with emitter (no output circuit)
R2PBA	2-wire operation; 105-130V ac (50/60Hz); SPST solid-state output
RPBB	210-250V ac (50/60Hz); SPST solid-state output
RPBB-1	210-250V ac (50/60Hz); use with emitter (no output circuit)
R2PBB	2-wire operation; 210-250V ac (50/60Hz); SPST solid-state output
RPBU	12-250V ac or 12-30V dc; SPST solid-state output (ac or dc)
RPBR	12-250V ac (50/60Hz) or 12-30V dc; SPST E/M relay output
RPBR2	12-250V ac (50/60Hz) or 12-30V dc; SPDT E/M relay output

Wiring Base (see data sheet P/N 03418)

RWB4	4-terminal wiring base for all models (except RPBTLM)
-------------	---

Logic Modules (see data sheet P/N 03417)

RLM5	ON/OFF delay (both functions adjustable up to 15 seconds)
RLM8	DELAYED ONE-SHOT (delay and pulse adjustable up to 15 seconds)

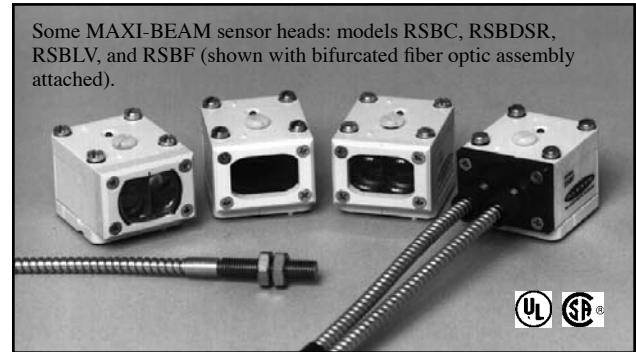

General Specifications

Construction: Reinforced molded VALOX[®] housing, molded acrylic lenses, o-ring and quad-ring gasketed components. Electronic components are fully epoxy encapsulated. NEMA 1, 3, 4, 12, and 13.

Operating Temperature: -40 to +70°C (-40 to +158°F).

Sensitivity Adjustment: Easily accessible, located on top of the sensor head beneath a watertight gasketed screw-cover. 15-turn clutched control; rotate clockwise to increase sensitivity.

Alignment Indicator: Red LED on top of sensor head. Banner's exclusive AID[™] circuit (*US patent no. 4356393) lights the LED whenever the sensor sees its own modulated light source, and pulses the LED at a rate proportional to the strength of the received light signal.

False Pulse Suppression on Power-up: 100ms delay on power-up.

Response Time and Repeatability: Specifications to follow in individual product descriptions are independent of signal strength.

VALOX[®] is a registered trademark of General Electric Co.

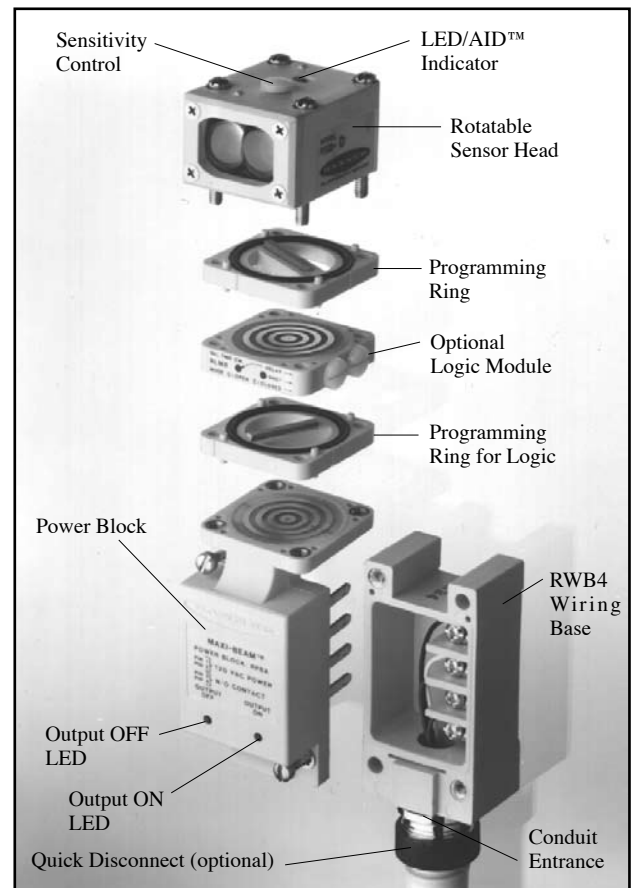

MAXI-BEAM Sensor Heads

Sensing Mode

Models

Excess Gain

Beam Pattern



RSBE & RSBR

Range: 300 feet (90 m) in "HP" (high power) and 2W (2 wire) modes
Beam: infrared, 880nm; visible red tracer beam
Effective Beam: 0.5" dia.
Response:
 HP, 2W mode: 10ms on/5 off
 HS mode: 1ms on/0.5 off
 SP mode: 0.3ms on/off
Repeatability: HP, 2W= 1.4ms; HS = 0.1ms; SP = 0.04ms

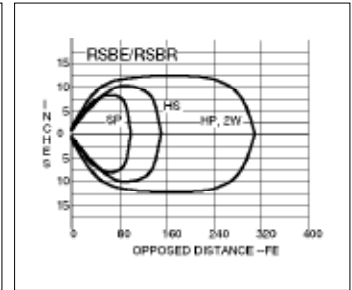
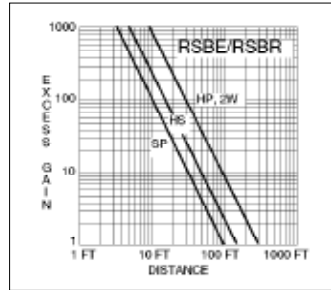

OPPOSED Mode



RSBESR & RSBRSR

Range: 15 feet (4.5m) in "HP" (high power) and 2W (2 wire) modes
Beam: infrared, 880nm
Response:
 HP, 2W modes: 10ms on/5 off
 HS mode: 1ms on/0.5 off
 SP mode: 0.3ms on/off
Repeatability: HP, 2W= 1.4ms; HS = 0.1ms; SP = 0.04ms

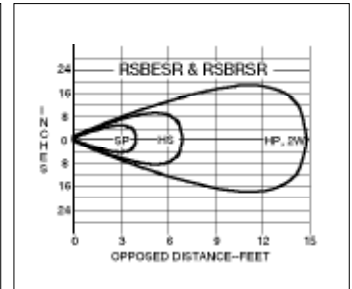
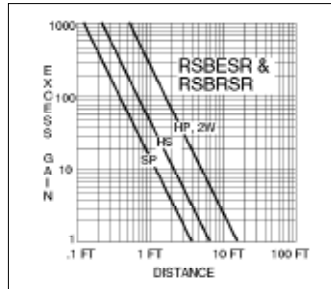

MAXI-BEAM emitters have a visible red "tracer beam". This beam is non-active, and is used as a means of visual alignment during installation. A retroreflector temporarily attached to the receiver lens provides an effective target for the tracer beam during alignment. The narrow beam of the RSBESR/RSBRSR pair is ideal for sensing small parts (effective beam diameter is 0.14 inch).



RSBEF & RSBRF

Range: see excess gain curves
Beam: infrared, 880nm.
Response:
 HP, 2W modes: 10ms
 HS mode: 1ms
 SP mode: 0.3ms on/off
Repeatability: HP, 2W= 3.3ms; HS = 0.3ms; SP = 0.1ms

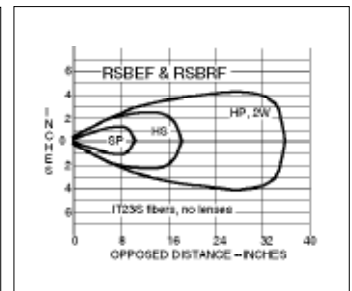
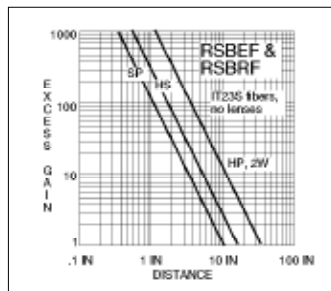

OPPOSED FIBER OPTIC Mode (glass fibers)

This sensor pair is designed for opposed mode operation using Banner glass fiber optics. Maximum range (HP mode) using L9 lenses is 12 feet. Maximum range using L16F lenses is 50 feet.



RSBLV

Range: 6 inches to 30 feet (9 m) in all program modes
Beam: visible red, 650nm
Response:
 HP, 2W, SP modes: 4ms
 HS mode: 1ms
Repeatability:
 HP, 2W, SP = 1.3ms; HS = 0.3ms

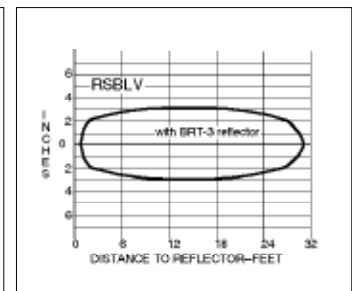
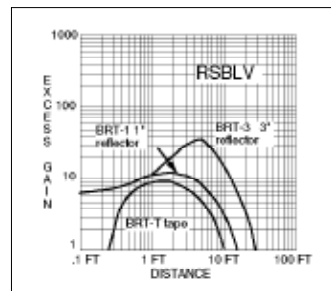

RETROREFLECTIVE Mode



RSBLVAG (anti-glare filter)

Range: 1 to 15 feet (4.5 m) in all program modes
Beam: visible red, 650nm; with polarizing filter
Response:
 HP, 2W, SP modes: 4ms
 HS mode: 1ms
Repeatability: HP, 2W, SP = 1.3ms; HS = 0.3ms

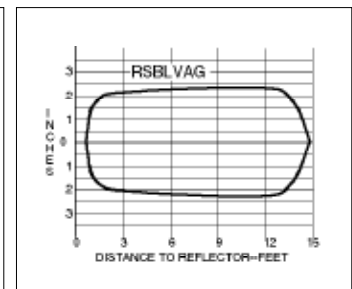
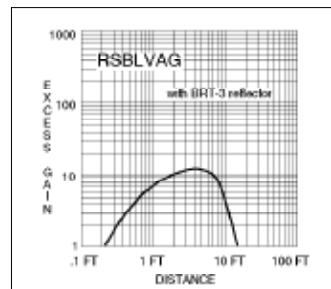

MAXI-BEAM Sensor Heads

Sensing Mode

Models

Excess Gain

Beam Pattern



RSBD

Range: 5 feet (1.5 m) in HP and 2W modes

Beam: infrared, 880nm

Response:

HP, 2W modes: 10ms

HS mode: 1ms

SP mode: 0.3ms

Repeatability: **HP, 2W**= 3.3ms; **HS** = 0.3ms; **SP** = 0.1ms

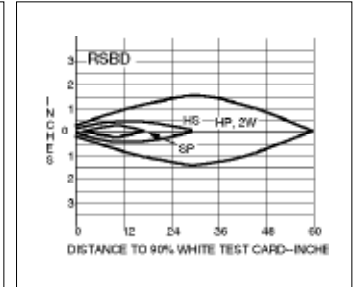
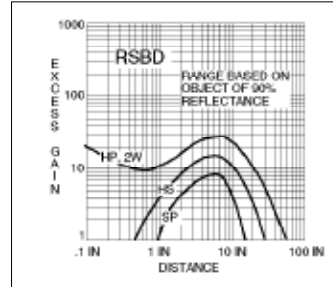

DIFFUSE Mode



RSBDSR

(short range)

Range: 30 inches (76cm) in HP and 2W modes

Beam: infrared, 880nm

Response:

HP, 2W modes: 10ms

HS mode: 1ms

SP mode: 0.3ms

Repeatability: **HP, 2W**= 3.3ms; **HS** = 0.3ms; **SP** = 0.1ms

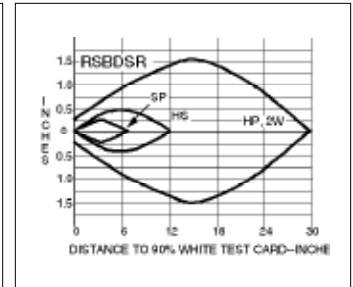
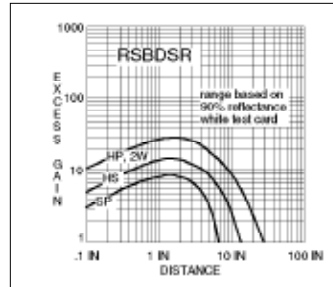

RSBC

Focus at 1.5 in. (38mm)

Beam: infrared, 940nm

Response:

HP, 2W modes: 10ms

HS mode: 1ms

SP mode: 0.3ms

Repeatability: **HP, 2W**= 3.3ms;

HS = 0.3ms;

SP = 0.1ms

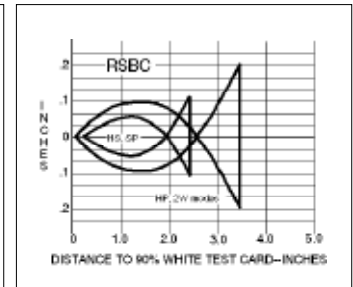
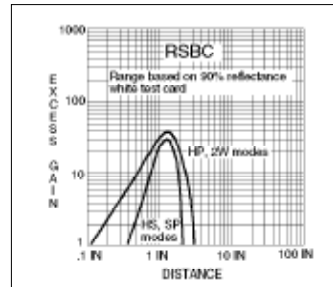

CONVERGENT Mode



RSBVCV

Focus at 1.5 in. (38mm); performance equal in all program modes.

Beam: visible red, 650nm.

Response:

HP, 2W, SP modes: 4ms

HS mode: 1ms

Repeatability: **HP, 2W, SP**= 1.3ms;

HS = 0.3ms

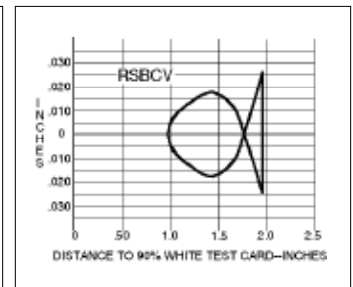
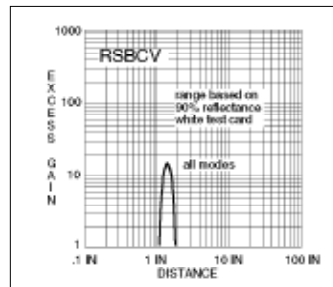

Powerful visible red beam with precise .06" diameter sensing spot. Useful in many high-contrast color registration applications.

FIXED-FIELD Mode



RSBFF models

Far limit cutoff at: 50mm (model RSBFF50) or 100mm (model RSBFF100)

Beam: infrared, 880nm.

Response:

HP mode: 10ms

Repeatability: **HP** mode: 3.3ms

Fixed-field sensor heads have an emitter element and two differently-aimed receiver elements. This creates a high-gain sensing field able to detect objects of low reflectivity, and a sharp far-limit sensing cutoff of 50mm (2 inches) or 100mm (4 inches) which ignores backgrounds beyond cutoff.

These sensors are ideal for detecting a part or surface that is only a fraction of an inch in front of another surface.

RSBFFs may not be used with 2-wire power blocks.

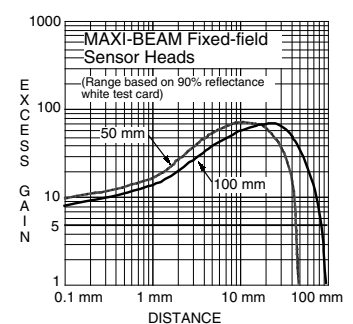

MAXI-BEAM Sensor Heads

Sensing Mode

Models

Excess Gain

Beam Pattern

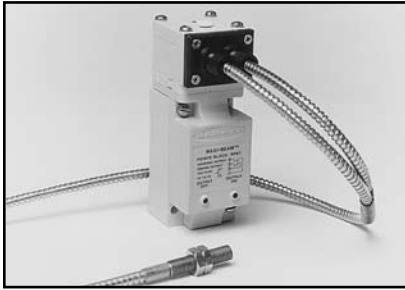

RSBF

Range: see excess gain curves

Beam: infrared, 880nm

Response:

HP, 2W modes: 10ms

HS mode: 1ms

SP mode: 0.3ms

Repeatability:

HP, 2W = 3.3ms;

HS = 0.3ms;

SP = 0.1ms

FIBER OPTIC Mode

(glass fibers)

OPPOSED MODE

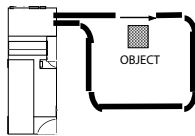

RETRO MODE

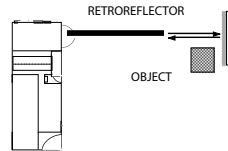

DIFFUSE MODE

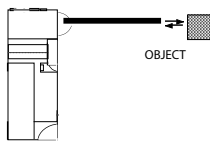

NOTE: if the retroreflective sensing mode is used in conjunction with the HP or 2W program mode, the GAIN control must be reduced from the factory setting in order to avoid optical feedback from the lens assembly.

For information on the complete line of Banner glass fiber optics, see Banner product catalog.

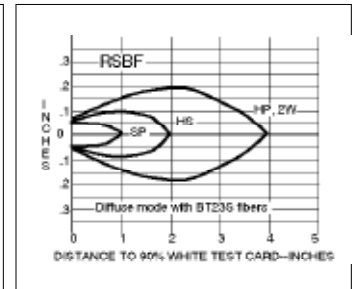
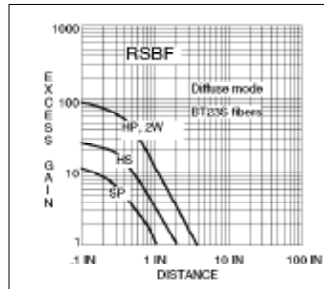
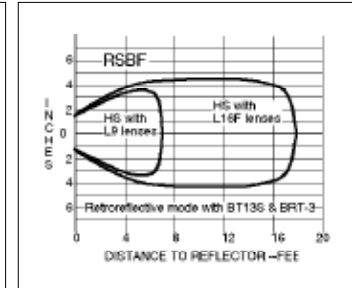
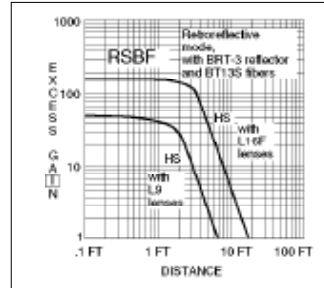
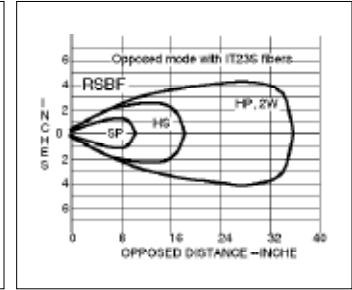
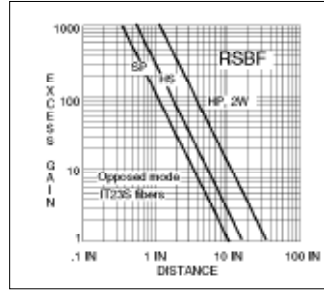

RSBFP

Range: see excess gain curves

Beam: visible red, 650nm.

Response:

HS mode only, 1ms on/off

Repeatability:

HS = 0.3ms

FIBER OPTIC Mode

OPPOSED MODE

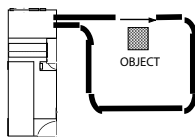

DIFFUSE MODE

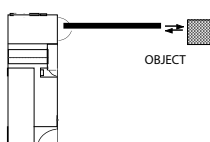

The model RSBFP will function only when programmed for the "HS" response mode.

The model RSBFP will not operate with 2-wire power blocks (models R2PBA and R2PBB).

For information on the complete line of Banner plastic fiber optics, see Banner product catalog.

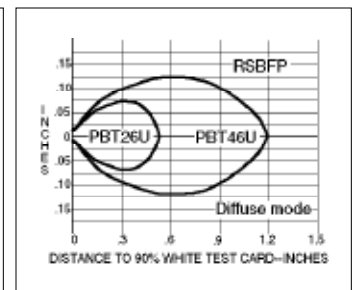
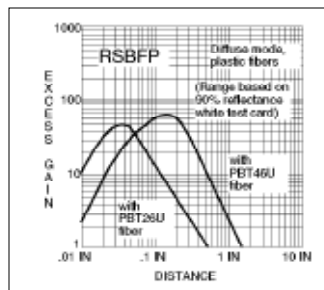
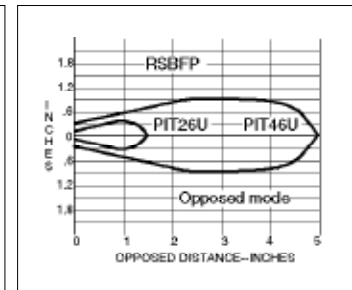
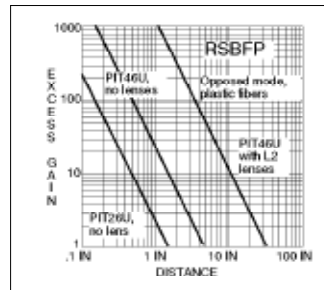

Model RSBFP is a visible-light sensor head designed for use with plastic fiber optics. It is compatible with all standard Banner plastic fiber optic assemblies (see Banner product catalog). In order to function properly, the RSBFP must be programmed for the "HS" response mode. The RSBFP is not for use with glass fiber optics (instead use model RSBF or RSBFV).

MAXI-BEAM Sensor Heads

Sensing Mode

Models

Excess Gain

Beam Pattern

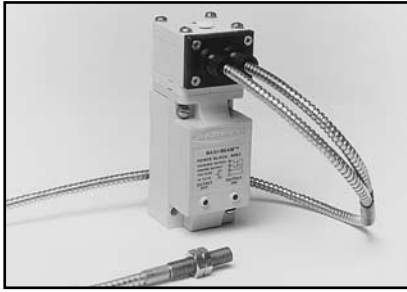

RSBFV

Range: see excess gain curves
 Beam: visible red, 650nm.
 Response:
 HS mode only, 1ms on/off
 Repeatability:
 HS = 0.3ms

The model RSBFV will function only when programmed for the "HS" response mode.

The model RSBFV will not operate with 2-wire power blocks (models R2PBA and R2PBB).

Model RSBFV is a visible-light sensor head designed for use with glass fiber optics. It is compatible with all standard Banner glass fiber optic assemblies (see Banner product catalog). In order to function properly, the RSBFV must be programmed for the "HS" response mode. The RSBFV is not for use with plastic fiber optics (instead use RSBFP).

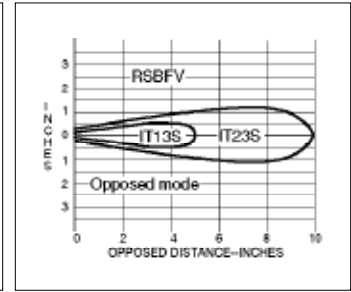
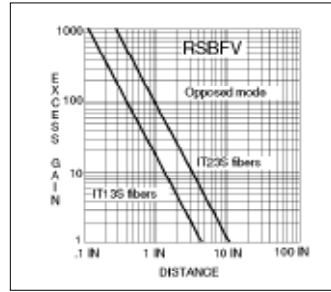

FIBER OPTIC Mode (glass fibers)

OPPOSED MODE

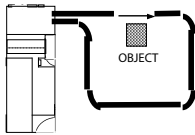

RETRO MODE

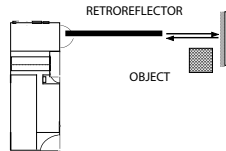

DIFFUSE MODE

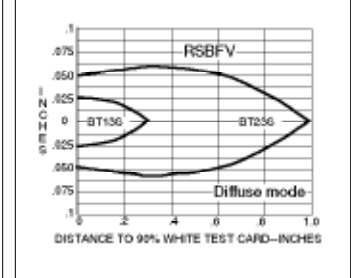
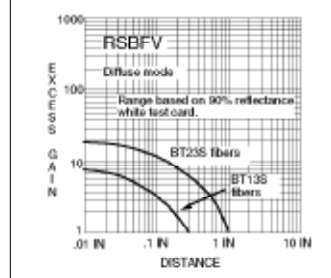
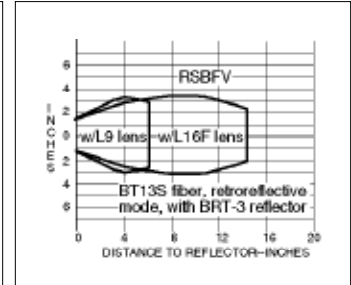
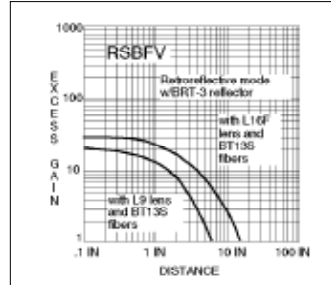
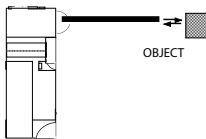

Programming the MAXI-BEAM Sensor Head

MAXI-BEAM sensor heads may be programmed for sensor response time (and range) and for LIGHT/DARK operate. Each sensor head is supplied with a programming ring which attaches below the the sensor head by a system of pegs. There are four programming notches around the perimeter of the ring. To program the sensor head, simply find the notch which will line up with the desired program combination (see diagram, right). NOTE: the programming ring may have to be turned upside-down in order to line up the notch with the program. If LIGHT OPERATE is selected, the MAXI-BEAM output will energize on a dark-to-light transition. If DARK OPERATE is selected, the MAXI BEAM output will energize on a light-to-dark transition. In the illustration, the MAXI-BEAM is set for high speed (HS) operation in the LIGHT OPERATE output state. See the information about each individual sensor head for the response time and range associated with each setting (HP, 2W, HS, SP). NOTE: when programming the RSBE, RSBSER, or RSBEF emitter, select the mode which is programmed for the receiver. EXCEPTION: if the receiver is programmed for the 2-wire (2W) mode, select high power (HP) on the emitter.

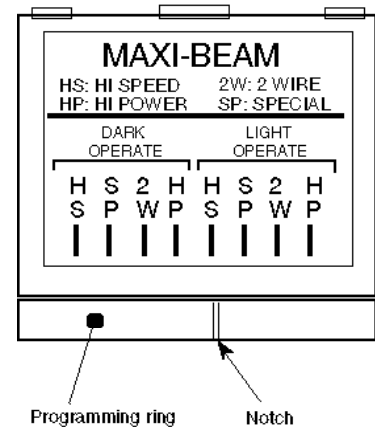

WARNING

MAXI-BEAM photoelectric presence sensors do NOT include the self-checking redundant circuitry necessary to allow their use in personnel safety applications. A sensor failure or malfunction can result in either an energized or de-energized sensor output condition. Never use these products as sensing devices for personnel protection. Their use as safety devices may create an unsafe condition which could lead to serious injury or death. Only MACHINE- GUARD and PERIMETER- GUARD Systems, and other systems so designated, are designed to meet OSHA and ANSI machine safety standards for point- of -operation guarding devices. No other Banner sensors or controls are designed to meet these standards, and they must NOT be used as sensing devices for personnel protection.

Dimension Drawing

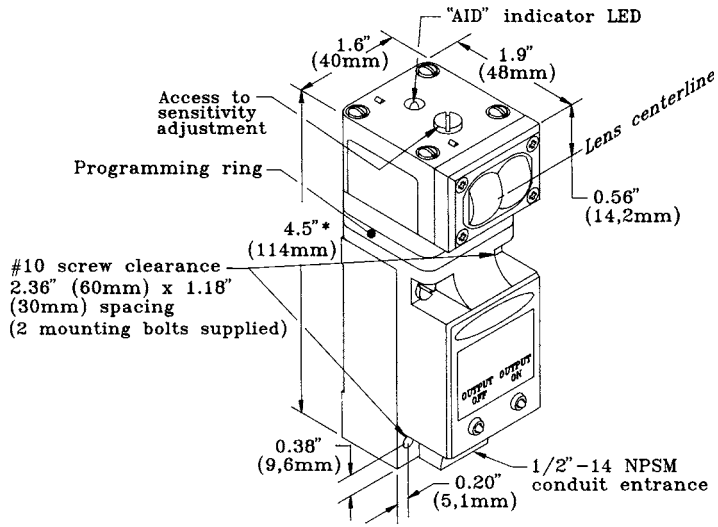

* 5.0" (127mm) with logic module and second programming ring installed.

Functional Schematic, MAXI-BEAM Sensor Heads

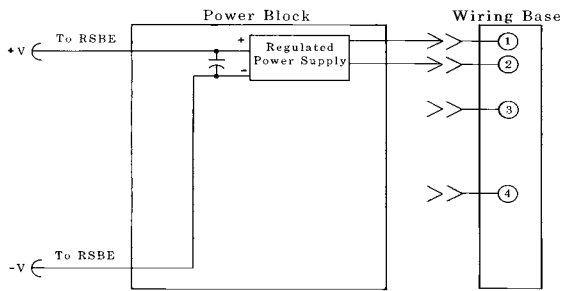

Composite Functional Schematic, MAXI-BEAM Sensors

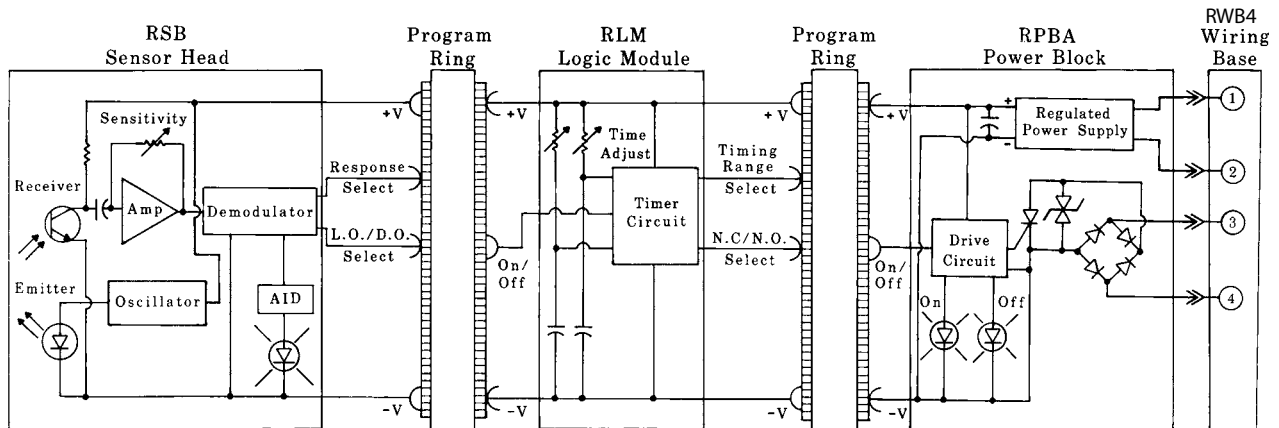

Banner Engineering Corp Limited Warranty

Banner Engineering Corp. warrants its products to be free from defects in material and workmanship for one year following the date of shipment. Banner Engineering Corp. will repair or replace, free of charge, any product of its manufacture which, at the time it is returned to the factory, is found to have been defective during the warranty period. This warranty does not cover damage or liability for misuse, abuse, or the improper application or installation of the Banner product.

THIS LIMITED WARRANTY IS EXCLUSIVE AND IN LIEU OF ALL OTHER WARRANTIES WHETHER EXPRESS OR IMPLIED (INCLUDING, WITHOUT LIMITATION, ANY WARRANTY OF MERCHANTABILITY OR FITNESS FOR A PARTICULAR PURPOSE), AND WHETHER ARISING UNDER COURSE OF PERFORMANCE, COURSE OF DEALING OR TRADE USAGE.

This Warranty is exclusive and limited to repair or, at the discretion of Banner Engineering Corp., replacement. **IN NO EVENT SHALL BANNER ENGINEERING CORP. BE LIABLE TO BUYER OR ANY OTHER PERSON OR ENTITY FOR ANY EXTRA COSTS, EXPENSES, LOSSES, LOSS OF PROFITS, OR ANY INCIDENTAL, CONSEQUENTIAL OR SPECIAL DAMAGES RESULTING FROM ANY PRODUCT DEFECT OR FROM THE USE OR INABILITY TO USE THE PRODUCT, WHETHER ARISING IN CONTRACT OR WARRANTY, STATUTE, TORT, STRICT LIABILITY, NEGLIGENCE, OR OTHERWISE.**

Banner Engineering Corp. reserves the right to change, modify or improve the design of the product without assuming any obligations or liabilities relating to any product previously manufactured by Banner Engineering Corp.