

Catalog #		Date		Prepared by	
Project		Type		Notes	

HALO™

OUTDOOR LIGHTING



SBL SOLAR AREA LIGHT | HIGH OUTPUT

WITH ALL-IN-TWO DESIGN AND 3 MODES OF OPERATION

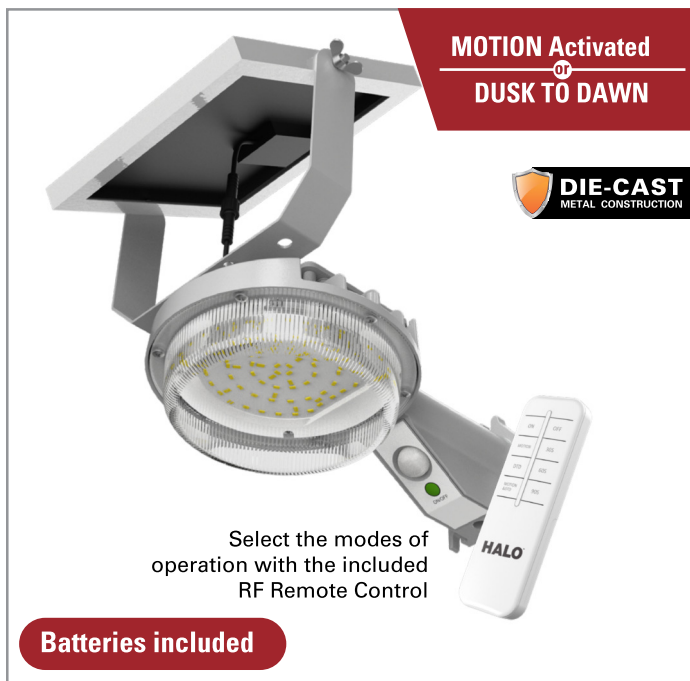

Illuminate your outdoor space with ease using our Solar Area Light. Featuring a robust die-cast housing that is resistant to harsh outdoor elements, this light will stand the test of time. The integrated LED with a traditional area light form factor provides ample brightness, with two high-output lumen packages available: 5,000 or 10,000 lumens. You can mount the solar panel in one of three ways: on top of the fixture, on a wall, or pole-mounted with 3ft of cable provided. And with the ability to mount up to 25ft, it's perfect for large outdoor areas.

TOP PRODUCT FEATURES



INTERACTIVE MENU

- [Order Information](#) page 5
- [Product Specification](#) page 6
- [Product Warranty](#) page 6
- [Product Dimensions](#) page 5
- [Photometric Data](#) page 6

- Off-Grid – completely free to operate, plus no expensive wiring required
- All-in-Two design with LED, Solar Panel, and LFP Battery requires no wiring making installation a breeze.
- Solar panel can be mounted three ways-wall, pole, or on top of fixture.
- Two High-Output lumen packages at 5000K available. (5,000 & 10,000 lumens)
- Can be mounted up to 25ft on a pole or to a wall
- Three selectable modes of operation with remote control including Motion, Dusk-to-dawn and Motion + Dusk-to-dawn.
- Premium PIR motion sensor with 180° detection range
- 3-year warranty for added peace of mind
- 60-minute run time on a full battery charge
- 8-hour recharge time to 100%
- 3ft (1M) of cable included in the box, 16FT extension cable sold separately.

PRODUCT CERTIFICATION



TYPICAL APPLICATIONS



COMMERCIAL & RESIDENTIAL OUTDOOR

- Garages
- Barns & Workshops
- Out Buildings
- Driveways
- Loading Areas
- Rural Areas
- Parks & Walkways
- Warehouses
- General Security Lighting

Or anywhere where trenching wire is cost prohibited.
Put light anywhere simply and easily with Solar Power!

MOUNTING LOCATION BEST PRACTICES

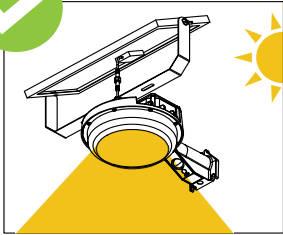

Most hours of direct sunlight, unblocked by trees or buildings

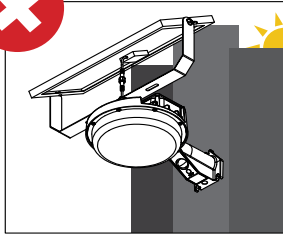

Limited or no direct sunlight, shaded or blocked by trees or buildings

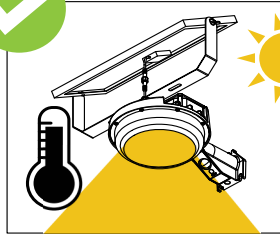

Warmer location with predominant sunshine = Maximum performance

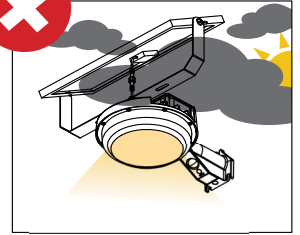

Cold location with consecutive cloud covered days = Possible inconsistent performance

PRODUCT FEATURE HIGHLIGHTS

ALL IN 1 DESIGN WITH REMOTE CONTROL

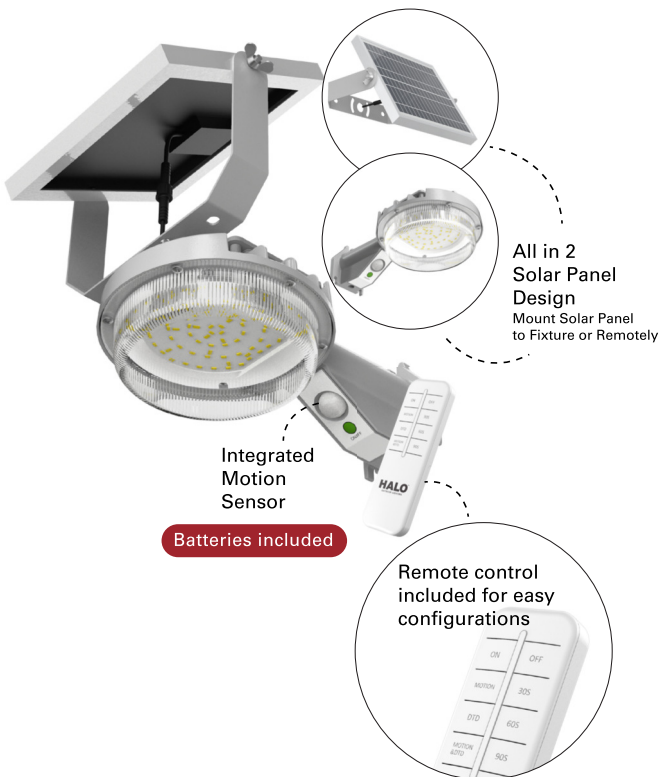

MULTIPLE WAYS TO MOUNT



WALL MOUNT
Mount light fixture to wall using included lag screws

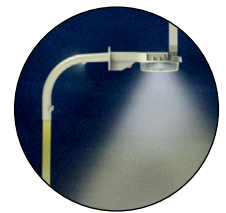

POLE MOUNT
Pole Mount (pole sold separately) by using included hardware

MULTIPLE WAYS TO MOUNT THE SOLAR PANEL



Mount Solar Panel directly on fixture



Mount Solar Panel Remotely on a wall



Mount solar panel remotely on a pole
With optional 16FT of cable to Mount Solar Panel far away from fixture for better performance

PRODUCT FEATURE HIGHLIGHTS (CONTINUATION)

INTEGRATED MOTION SENSOR

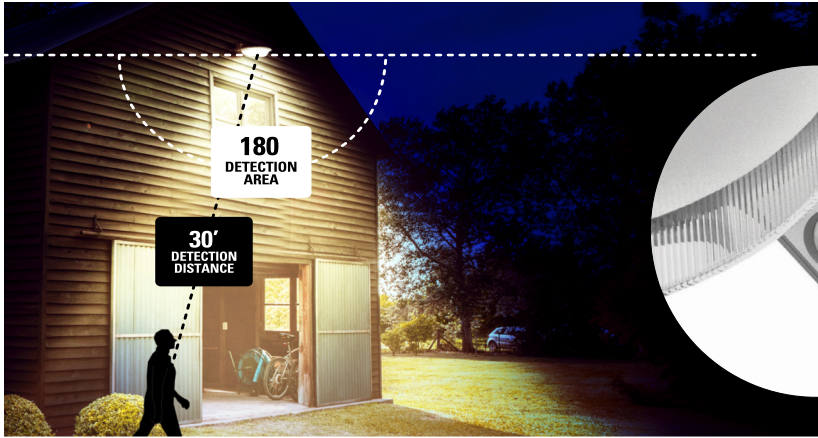

Fixture can be mounted 25' and motion sensor has a detection angle(range) of 180 Degrees and can detect people up to 30' away.

REMOTE CONTROL SETTINGS

Modes of operation

- Motion: Light flashes 1X
- Dusk to Dawn : Light flashes 2X
- Motion + Dusk to Dawn : Light flashes 3X

Manual ON

Manual OFF

Motion Mode auto time out settings

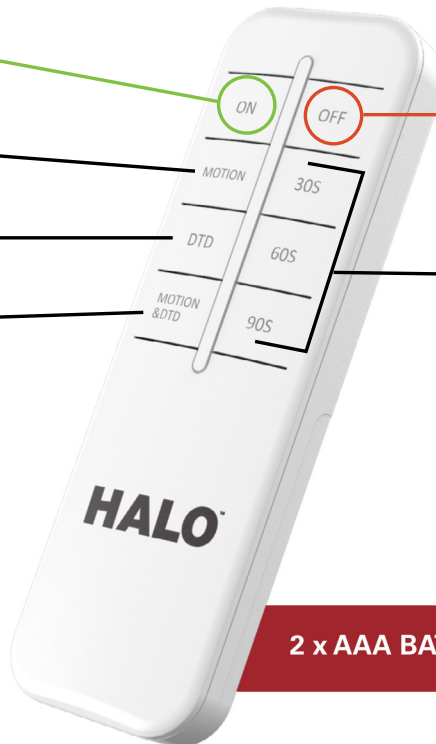

2 x AAA BATTERIES INCLUDED

MODES OF OPERATION

 **After sun down**
Fixture turns on

 **At sunrise**
Fixture turns off

DUSK to DAWN MODE



MOTION ACTIVATED MODE

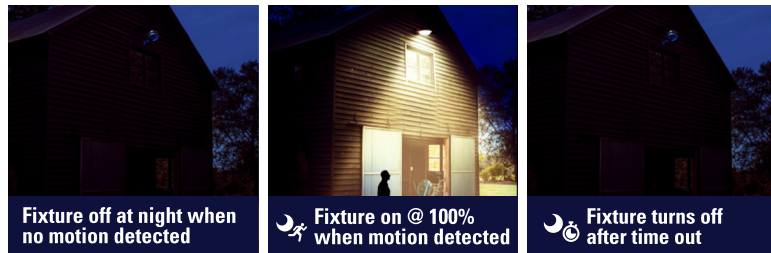

DUSK to DAWN + MOTION ACTIVATED MODE



Catalog Number	Initial Lumen Output	Operation Mode	Lumens in Motion Mode	Lumens in D2D Mode	Initial Lumen	Runtime	Final Lumen
SBL50A50GY	5000LM	Motion	5000	NA	5000	60 Min	2000
		Motion + D2D	1500 (30min)	400	400	11 Hrs 30 Min	0
		D2D	NA	600	600	12 hrs	0
SBL100A50GY	10000LM	Motion	10000	NA	10000	60 Min	2000
		Motion + D2D	3000 (30 min)	800	800	11 Hrs 30 Min	0
		D2D	NA	1200	1200	12 hrs	0

ORDER INFORMATION

Catalog Number	Description	Material No.	UPC	Case Qty	Case Dimensions (in.)			Weight (lbs)
					L	W	H	
SBL50A50GY	SOLAR BARN LIGHT,5000LM,5000K,MTN+D2D,GY	13604694	080083260522	2	11.73	9.49	5.04	4.86
SBL100A50GY	SOLAR BARN LIGHT,10000LM,5000K,MTN+D2D,GY	13604695	080083260546	2	17.32	9.06	6.58	8.07
SBL-EXTCBL-16	SOLAR BARN LIGHT 16FT EXT CBL 5KLM 10KLM	13634772	080083276653	100	17.72	12.80	10.43	30.00

PRODUCT DIMENSIONS

SBL50A50GY

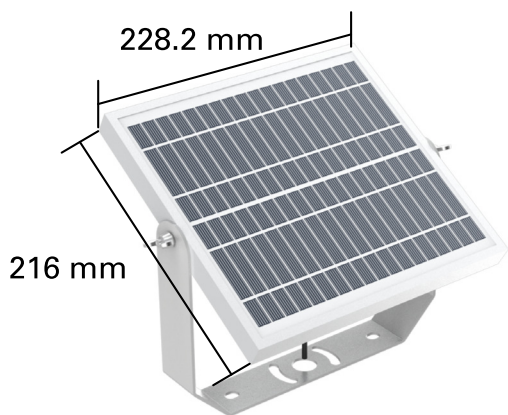
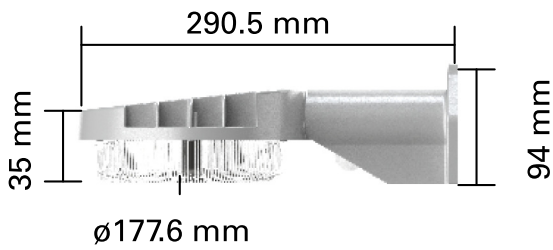

SBL100A50GY

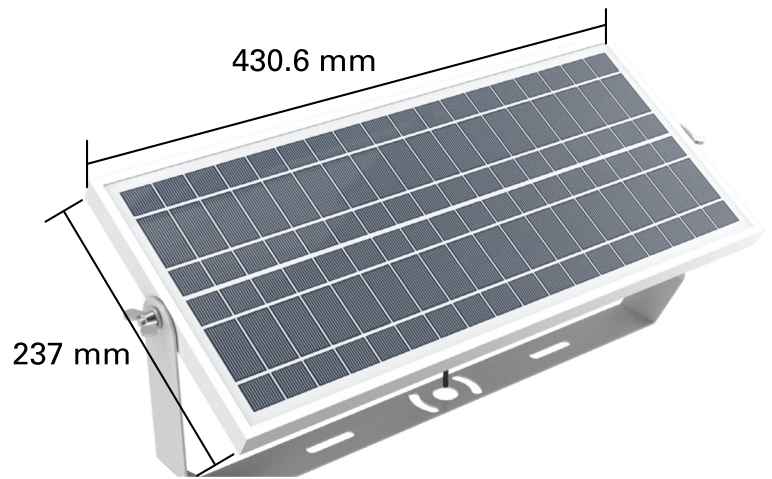
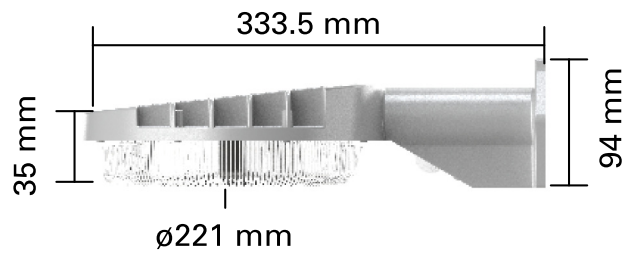

PRODUCT SPECIFICATIONS

Construction

- Robust Die-Cast housing.
- Housing suitable for wet locations and is resistant to harsh outdoor conditions.
- All-in-two design that includes fixture housing, mountable solar panel, battery, remote and LED light source
- UV & impact resistant prismatic drop lens provides diffuse and wide light distribution
- Powder coated textured gray finish.
- LED indicator light provides battery charging & discharging status

Controls

- 3 different operating modes configurable with included RF Remote control and also including standard On/Off functionality.
 - Motion Mode
 - Dusk to Dawn Mode
 - Motion + Dusk to Dawn Mode
- Auto Time Out settings of 30S, 60S & 90S when using a motion mode before light turns off
- Dimming levels determined by selected mode of operation.
- Remote Control Range: 32ft to 49ft

Motion Sensor

- Passive Infrared motion sensor with a 180° detection range.
- Maximum detection distance of 30'.

Mounting

- Wall mount using included (3) lag screws and washers.
- Pole mount to any standard 2" curved pole (sold separately)
- Mounting hardware included in packaging.

Electrical

- 5000K bright cool white light is optimal for security lighting .
- Maintenance - free LEDs with estimated 50,000 hours lifespan based on LM-80 results and TM-21 calculations.
- Rated for ambient operating temperature range from -4°F (-20°C) to 104°F (40°C)
- CRI >70

Compliance

- UL certified for USA and Canada for wet locations.
- Contains no mercury or lead - RoHS compliant (RoHS 2.0)
- UL Wet location
- UN38.3 transportation certified

Battery

- Total battery capacity of 60 minutes if run continuously at full brightness.
- Battery recharge time of 8 hours in full direct sunlight
- Batteries are not removable or replaceable from the fixture
- Battery optimal charging temperature range of 32F(0C) to 113F(45C)

Warranty

- Three year limited warranty, consult website for details. www.cooperlighting.com

OPTIONAL ACCESSORIES (SOLD SEPARATELY)



SBL-EXTCBL-16
Solar Barn Light
16FT Extension
Cable



SBL-RC
Solar Barn Light,
Remote Control



EA24
24in Mounting
Arm for Area
Lights

PHOTOMETRIC DATA

Catalog Number	CCT	Watts	Initial Lumens	CRI
SBL50A50GY	5000K	33.5W	5000	73.37
SBL100A50GY	5000K	79.5W	10000	74.1

SUGGESTED MOUNTING HEIGHT

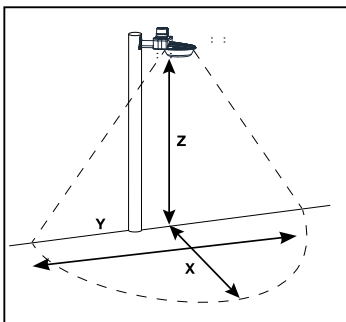

Minimum Footcandles (FC)		0.50 FC							
Mounting Height (Z)		8'		10'		15'		20'	
Catalog Number	Lumens	X	Y	X	Y	X	Y	X	Y
SBL50A50GY	5000	18	37	21	41	24	49	27	53
SBL100A50GY	10000	22	44	25	50	30	61	34	68

X = Forward Throw
Y = Wall Spread
Z = Mounting Heights

Notes:
Forward throw X = 1/2 Y for wall-mount applications only
See IES files for detailed photometry

Catalog #		Date		Prepared by	
Project		Type		Notes	

HALO™

OUTDOOR LIGHTING



SBL SOLAR AREA LIGHT | HIGH OUTPUT

WITH ALL-IN-TWO DESIGN AND 3 MODES OF OPERATION

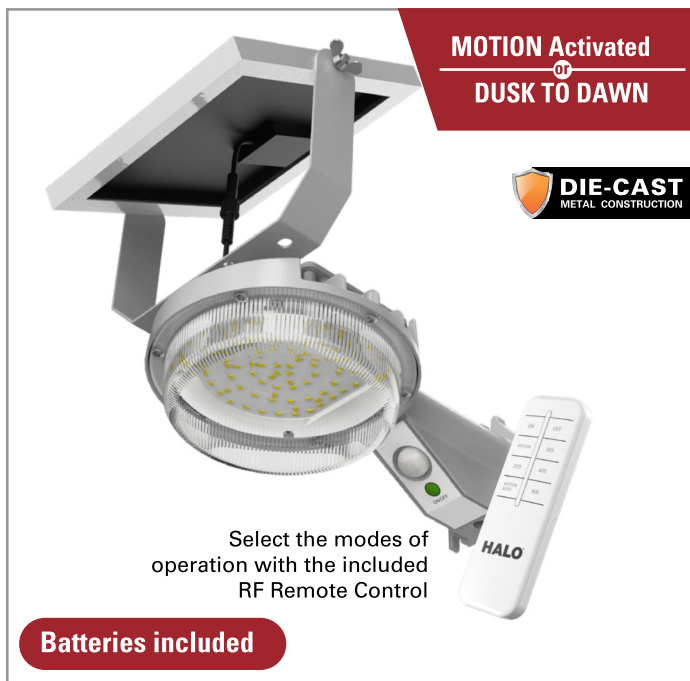

Illuminate your outdoor space with ease using our Solar Area Light. Featuring a robust die-cast housing that is resistant to harsh outdoor elements, this light will stand the test of time. The integrated LED with a traditional area light form factor provides ample brightness, with two high-output lumen packages available: 5,000 or 10,000 lumens. You can mount the solar panel in one of three ways: on top of the fixture, on a wall, or pole-mounted with 3ft of cable provided. And with the ability to mount up to 25ft, it's perfect for large outdoor areas.

TOP PRODUCT FEATURES



INTERACTIVE MENU

- [Order Information](#) page 5
- [Product Specification](#) page 6
- [Product Warranty](#) page 6
- [Product Dimensions](#) page 5
- [Photometric Data](#) page 6

- Off-Grid – completely free to operate, plus no expensive wiring required
- All-in-Two design with LED, Solar Panel, and LFP Battery requires no wiring making installation a breeze.
- Solar panel can be mounted three ways-wall, pole, or on top of fixture.
- Two High-Output lumen packages at 5000K available. (5,000 & 10,000 lumens)
- Can be mounted up to 25ft on a pole or to a wall
- Three selectable modes of operation with remote control including Motion, Dusk-to-dawn and Motion + Dusk-to-dawn.
- Premium PIR motion sensor with 180° detection range
- 3-year warranty for added peace of mind
- 60-minute run time on a full battery charge
- 8-hour recharge time to 100%
- 3ft (1M) of cable included in the box, 16FT extension cable sold separately.

PRODUCT CERTIFICATION



TYPICAL APPLICATIONS



COMMERCIAL & RESIDENTIAL OUTDOOR

- Garages
- Barns & Workshops
- Out Buildings
- Driveways
- Loading Areas
- Rural Areas
- Parks & Walkways
- Warehouses
- General Security Lighting

Or anywhere where trenching wire is cost prohibited.
Put light anywhere simply and easily with Solar Power!

MOUNTING LOCATION BEST PRACTICES

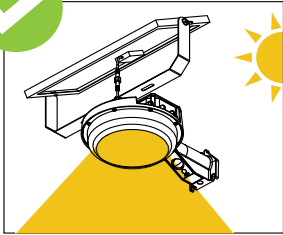

Most hours of direct sunlight, unblocked by trees or buildings

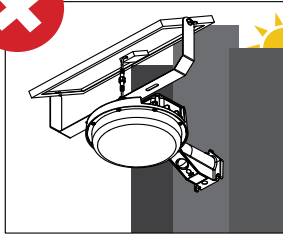

Limited or no direct sunlight, shaded or blocked by trees or buildings

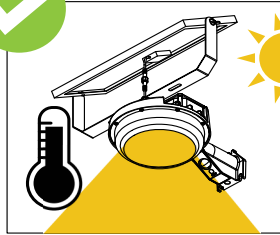

Warmer location with predominant sunshine = Maximum performance

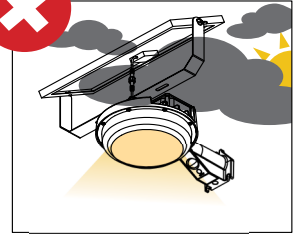

Cold location with consecutive cloud covered days = Possible inconsistent performance

PRODUCT FEATURE HIGHLIGHTS

ALL IN 1 DESIGN WITH REMOTE CONTROL

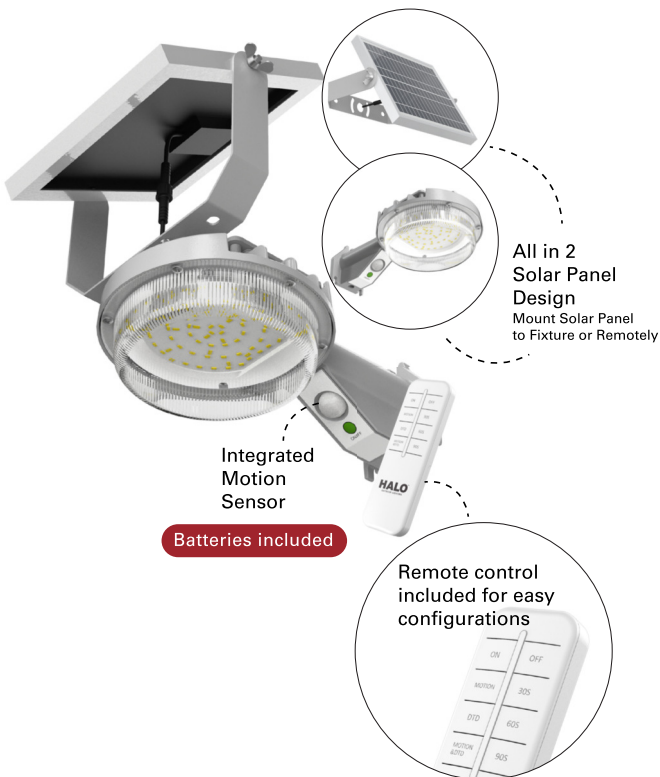

MULTIPLE WAYS TO MOUNT



WALL MOUNT
Mount light fixture to wall using included lag screws

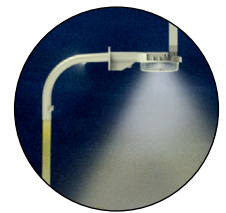

POLE MOUNT
Pole Mount (pole sold separately) by using included hardware

MULTIPLE WAYS TO MOUNT THE SOLAR PANEL



Mount Solar Panel directly on fixture



Mount Solar Panel Remotely on a wall

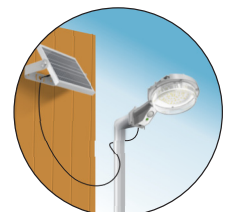

Mount solar panel remotely on a pole
With optional 16FT of cable to Mount Solar Panel far away from fixture for better performance

PRODUCT FEATURE HIGHLIGHTS (CONTINUATION)

INTEGRATED MOTION SENSOR



Fixture can be mounted 25' and motion sensor has a detection angle(range) of 180 Degrees and can detect people up to 30' away.

REMOTE CONTROL SETTINGS

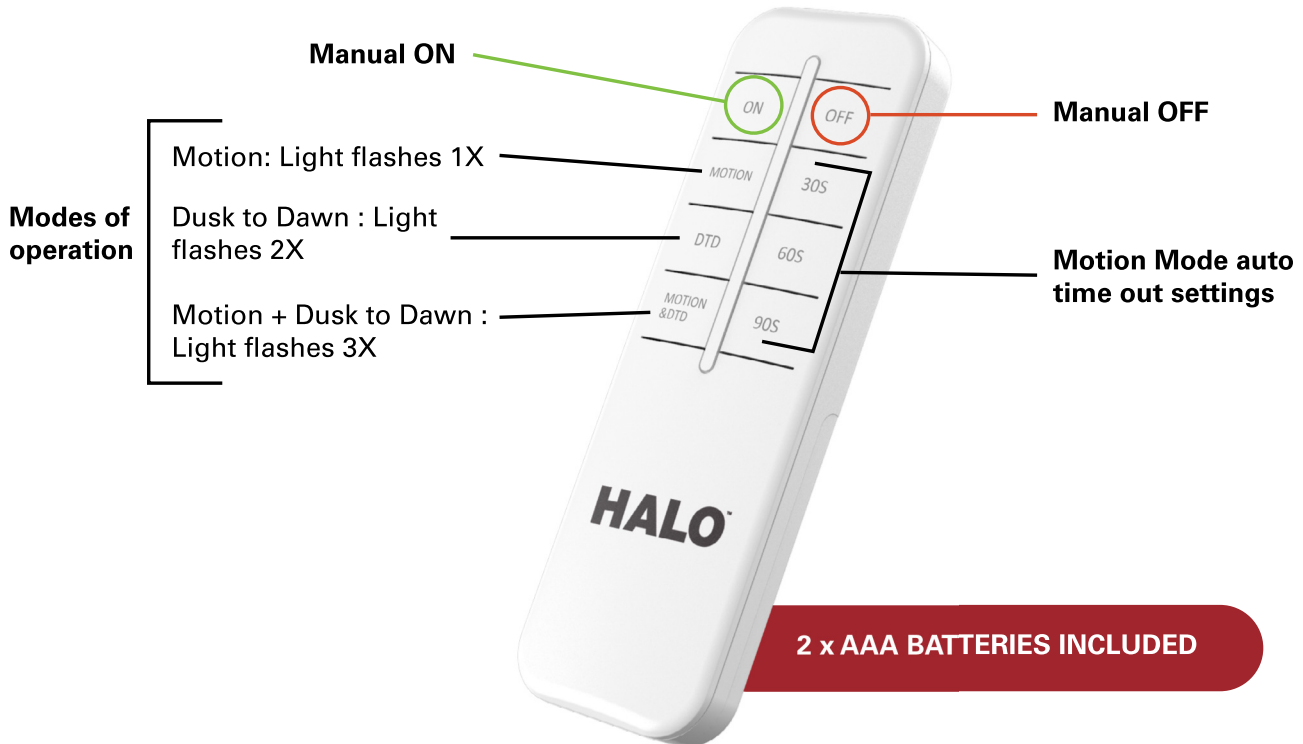

MODES OF OPERATION



After sun down
 Fixture turns on

At sunrise
 Fixture turns off

DUSK to DAWN MODE

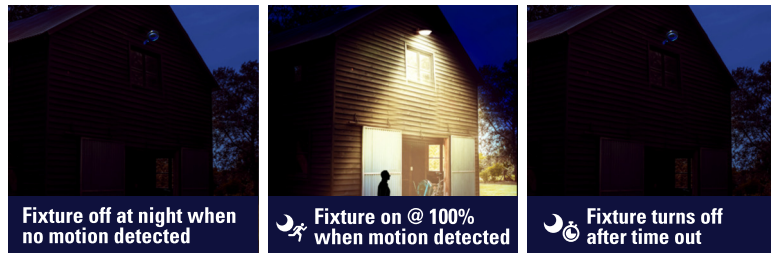

MOTION ACTIVATED MODE



DUSK to DAWN + MOTION ACTIVATED MODE



Catalog Number	Initial Lumen Output	Operation Mode	Lumens in Motion Mode	Lumens in D2D Mode	Initial Lumen	Runtime	Final Lumen
SBL50A50GY	5000LM	Motion	5000	NA	5000	60 Min	2000
		Motion + D2D	1500 (30min)	400	400	11 Hrs 30 Min	0
		D2D	NA	600	600	12 hrs	0
SBL100A50GY	10000LM	Motion	10000	NA	10000	60 Min	2000
		Motion + D2D	3000 (30 min)	800	800	11 Hrs 30 Min	0
		D2D	NA	1200	1200	12 hrs	0

ORDER INFORMATION

Catalog Number	Description	Material No.	UPC	Case Qty	Case Dimensions (in.)			Weight (lbs)
					L	W	H	
SBL50A50GY	SOLAR BARN LIGHT,5000LM,5000K,MTN+D2D,GY	13604694	080083260522	2	11.73	9.49	5.04	4.86
SBL100A50GY	SOLAR BARN LIGHT,10000LM,5000K,MTN+D2D,GY	13604695	080083260546	2	17.32	9.06	6.58	8.07
SBL-EXTCBL-16	SOLAR BARN LIGHT 16FT EXT CBL 5KLM 10KLM	13634772	080083276653	100	17.72	12.80	10.43	30.00

PRODUCT DIMENSIONS

SBL50A50GY

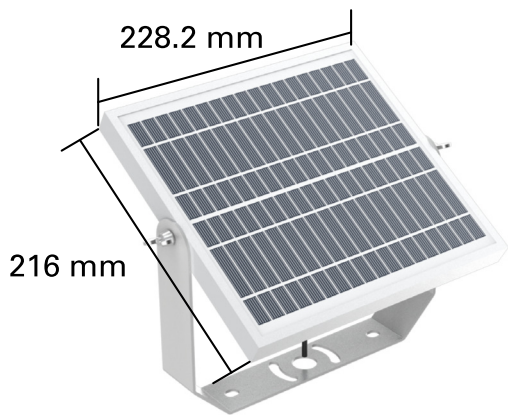
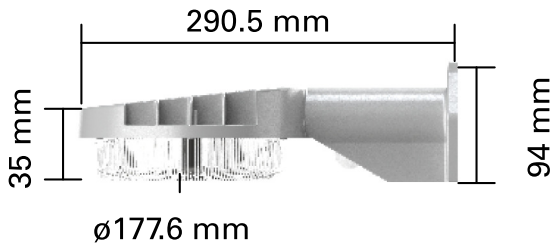

SBL100A50GY

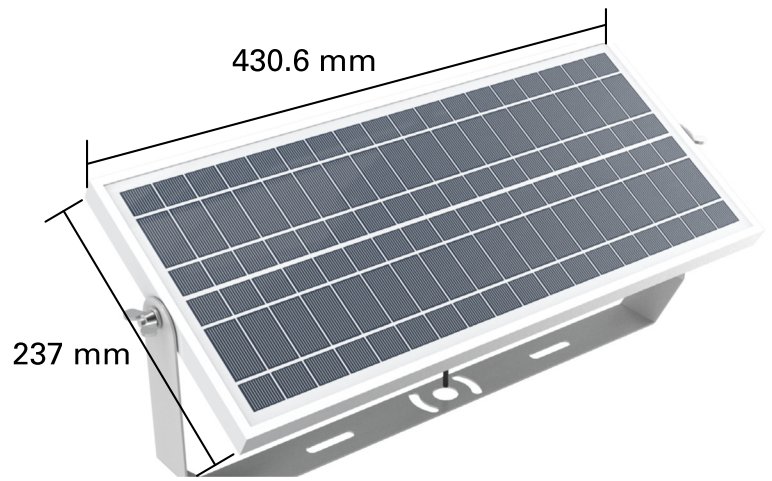
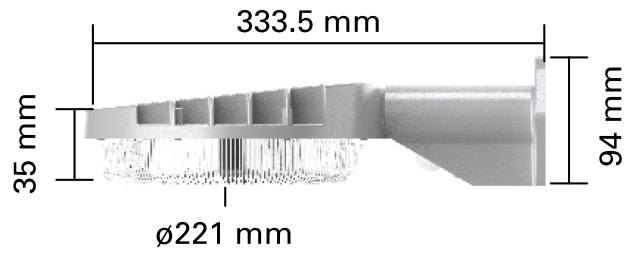

PRODUCT SPECIFICATIONS

Construction

- Robust Die-Cast housing.
- Housing suitable for wet locations and is resistant to harsh outdoor conditions.
- All-in-two design that includes fixture housing, mountable solar panel, battery, remote and LED light source
- UV & impact resistant prismatic drop lens provides diffuse and wide light distribution
- Powder coated textured gray finish.
- LED indicator light provides battery charging & discharging status

Controls

- 3 different operating modes configurable with included RF Remote control and also including standard On/Off functionality.
 - Motion Mode
 - Dusk to Dawn Mode
 - Motion + Dusk to Dawn Mode
- Auto Time Out settings of 30S, 60S & 90S when using a motion mode before light turns off
- Dimming levels determined by selected mode of operation.
- Remote Control Range: 32ft to 49ft

Motion Sensor

- Passive Infrared motion sensor with a 180° detection range.
- Maximum detection distance of 30'.

Mounting

- Wall mount using included (3) lag screws and washers.
- Pole mount to any standard 2" curved pole (sold separately)
- Mounting hardware included in packaging.

Electrical

- 5000K bright cool white light is optimal for security lighting .
- Maintenance - free LEDs with estimated 50,000 hours lifespan based on LM-80 results and TM-21 calculations.
- Rated for ambient operating temperature range from -4°F (-20°C) to 104°F (40°C)
- CRI >70

Compliance

- UL certified for USA and Canada for wet locations.
- Contains no mercury or lead - RoHS compliant (RoHS 2.0)
- UL Wet location
- UN38.3 transportation certified

Battery

- Total battery capacity of 60 minutes if run continuously at full brightness.
- Battery recharge time of 8 hours in full direct sunlight
- Batteries are not removable or replaceable from the fixture
- Battery optimal charging temperature range of 32F(0C) to 113F(45C)

Warranty

- Three year limited warranty, consult website for details. www.cooperlighting.com

OPTIONAL ACCESSORIES (SOLD SEPARATELY)



SBL-EXTCBL-16
Solar Barn Light
16FT Extension
Cable



SBL-RC
Solar Barn Light,
Remote Control



EA24
24in Mounting
Arm for Area
Lights

PHOTOMETRIC DATA

Catalog Number	CCT	Watts	Initial Lumens	CRI
SBL50A50GY	5000K	33.5W	5000	73.37
SBL100A50GY	5000K	79.5W	10000	74.1

SUGGESTED MOUNTING HEIGHT

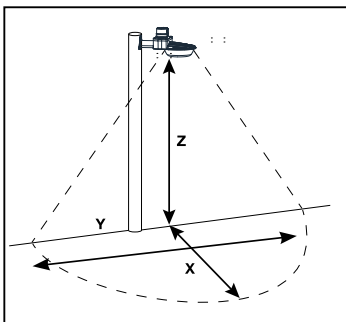

Minimum Footcandles (FC)		0.50 FC							
Mounting Height (Z)		8'		10'		15'		20'	
Catalog Number	Lumens	X	Y	X	Y	X	Y	X	Y
SBL50A50GY	5000	18	37	21	41	24	49	27	53
SBL100A50GY	10000	22	44	25	50	30	61	34	68

X = Forward Throw
Y = Wall Spread
Z = Mounting Heights

Notes:
Forward throw X = 1/2 Y for wall-mount applications only
See IES files for detailed photometry