



LIGHTING FIXTURES



Friendly Service... Powerful Solutions™

About Topaz

Our Business

A family-owned, U.S.-based company, Topaz manufactures lamps, fixtures and electrical supplies for commercial and residential, indoor and outdoor applications. From stadium to specialty lighting, we deliver a world-class selection of the most energy efficient products on the market today.

What Have We Learned?

With over 30 years of experience in the lighting industry, Topaz knows a thing or two about what issues are important to our customers. We believe in offering an inventory of quality, energy efficient products with versatile applications at fair prices. We work hard to offer the most professional and friendliest customer service to all of our valued clients.

Staying Current in Today's Always-Evolving Marketplace

As the shape of the lighting industry continues to evolve, Topaz is firmly committed to staying ahead of the technological power curve. We are proud to showcase our updated and comprehensive line of fixtures and lighting products. Have questions? Our friendly and knowledgeable sales team will be happy to help you. Ready to place an order? Contact your Topaz representative today to see how Topaz products can work for you.





Table of Contents

LED Indoor Lighting

Flat Panels	6-7
Volumetric Troffers.....	8-11
Linear 36W Luminaire.....	12-13
Linear Strip and Wrap	14-15
Linear High Bay	16-17
UFO High Bay Lighting.....	18-19
Residential Flush Mount Fixtures	20-21
Surface Mount Disk Lights.....	22-23
Retrofit Units.....	24-27
New Construction/Remodel Housings.....	28-29

LED Outdoor Lighting

Compact Flood Light.....	32-33
Low Profile Flood Lights.....	34-35
Architectural Wall Pack/Flood Lights.....	36-37
Traditional Wall Packs	38-39
Architectural Slim Wall Packs	40-41
Full Cutoff Wall Pack.....	42-43
Small Wall Packs.....	44-45
Canopy and Parking Garage Lights	46-47
Round Canopy Lights	48-49
Dusk-to-Dawn.....	50-51
Parking Lot/Area Lights.....	52-53

Line Voltage Recessed Downlighting

4" Line Voltage	56-59
5" Line Voltage	60-61
6" Line Voltage	62-71
6" Line Voltage for Sloped Ceilings	72-75
4" GU10	76-79
4" and 6" GU24	80-85

Low Voltage Recessed Downlighting

3" and 4" Low Voltage	88-95
-----------------------------	-------

Accessories	96-97
--------------------------	-------

Nomenclature	98
---------------------------	----

Index	100-101
--------------------	---------

Warranty	102-103
-----------------------	---------



LED Indoor Lighting

Topaz's indoor LED fixtures are the perfect long life alternative to traditional lighting technologies. By reducing energy and maintenance costs, they offer a lower cost of ownership. Commercial options include flat panels, architectural style troffers and stylish linear luminaires. Residential products include a line of LED retrofits for recessed applications, flush mount ceiling fixtures and disk lights—all featured in attractive designs and finishes. Topaz's LED commercial and residential fixtures are available with either DLC® or ENERGY STAR® qualification.



LED Flat Panels

With edge-to-edge, evenly diffused, glare-free light, Topaz's LED Flat Panels provide a contemporary solution to replace inefficient fluorescent fixtures. Available in 3000K (warm white), 3500K (neutral white), 4000K (cool white) and 5000K (daylight) correlated color temperatures, our LED Flat Panels cast the right light in any commercial setting. Designed for drop-in ceilings or surface mount installations, the slim profile fixtures are available in 1' x 4', 2' x 2' or 2' x 4' sizes and can save up to 50% of energy usage compared to traditional fluorescent fixtures. Standard 0-10V dimming capability allows greater energy-savings and optional emergency backup available for 90 minutes of uninterrupted service during a power loss.



1' x 4'

2' x 2'

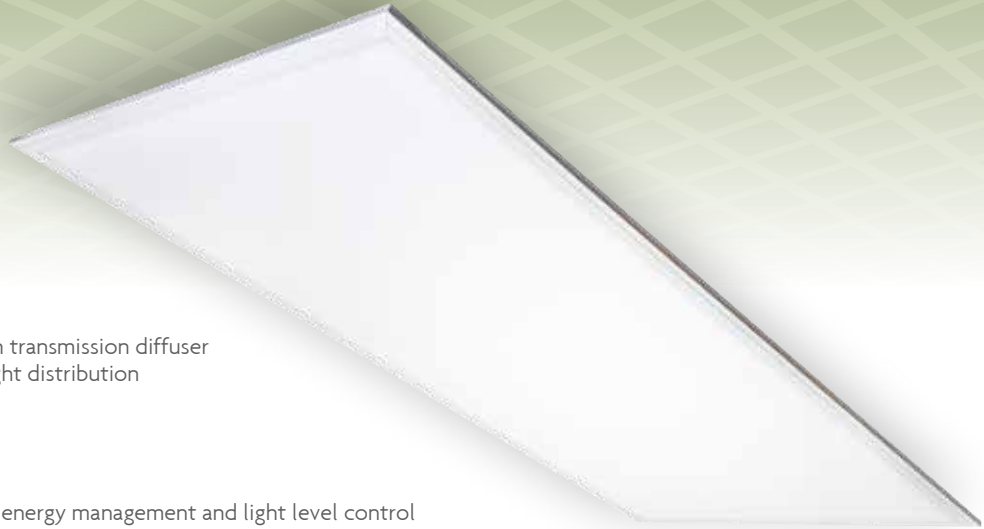

2' x 4'

Features

- LED edge lit design with high transmission diffuser providing even, glare-free light distribution
- PMMA light guide
- White frame construction
- PF >0.9 and THD <15%
- Standard 0-10V dimming for energy management and light level control
- Luminous efficacy of up to 130 Lumens/Watt
- Emergency back-up options available
- Applications: Schools, hospitals and offices

Item #	Order Code	Size (ft)	Volts	Watts	Lumens	LPW	CCT (Kelvin)	CRI	Beam Angle	Dimmable	DLC
High Performance 1' x 4'											
F-L14/32/830/D/HP	72800	1' x 4'	120-277VAC	32	3,400	106	3000	80	150°	0-10V	Y
F-L14/32/835/D/HP	72802	1' x 4'	120-277VAC	32	3,450	108	3500	80	150°	0-10V	Y
F-L14/32/840/D/HP	72804	1' x 4'	120-277VAC	32	3,550	111	4000	80	150°	0-10V	Y
F-L14/32/850/D/HP	72806	1' x 4'	120-277VAC	32	3,600	113	5000	80	150°	0-10V	Y
High Performance 2' x 2'											
F-L22/32/830/D/HP	70944	2' x 2'	120-277VAC	32	3,400	106	3000	80	150°	0-10V	Y
F-L22/32/835/D/HP	70945	2' x 2'	120-277VAC	32	3,450	108	3500	80	150°	0-10V	Y
F-L22/32/840/D/HP	70946	2' x 2'	120-277VAC	32	3,550	111	4000	80	150°	0-10V	Y
F-L22/32/850/D/HP	70947	2' x 2'	120-277VAC	32	3,600	113	5000	80	150°	0-10V	Y
High Performance 2' x 4'											
F-L24/38/830/D/HP	70948	2' x 4'	120-277VAC	38	4,200	111	3000	80	150°	0-10V	Y
F-L24/38/835/D/HP	70949	2' x 4'	120-277VAC	38	4,250	112	3500	80	150°	0-10V	Y
F-L24/38/840/D/HP	70950	2' x 4'	120-277VAC	38	4,350	114	4000	80	150°	0-10V	Y
F-L24/38/850/D/HP	70951	2' x 4'	120-277VAC	38	4,400	116	5000	80	150°	0-10V	Y
High Efficiency 2' x 2'											
F-L22/40/835/D/HE	73347	2' x 2'	120-277VAC	40	4,800	120	3500	80	150°	0-10V	Y
F-L22/40/840/D/HE	73348	2' x 2'	120-277VAC	40	5,200	130	4000	80	150°	0-10V	Y
F-L22/40/850/D/HE	73349	2' x 2'	120-277VAC	40	5,200	130	5000	80	150°	0-10V	Y
High Efficiency 2' x 4'											
F-L24/50/835/D/HE	73350	2' x 4'	120-277VAC	50	6,000	120	3500	80	150°	0-10V	Y
F-L24/50/840/D/HE	73351	2' x 4'	120-277VAC	50	6,500	130	4000	80	150°	0-10V	Y
F-L24/50/850/D/HE	73352	2' x 4'	120-277VAC	50	6,500	130	5000	80	150°	0-10V	Y

Mounting Accessories (Sold separately)

Frame - Surface Mount Application

F-L1X4-FRAME	78628	1' x 4'	48" x 12" x 2.6"
F-L2X2-FRAME	78630	2' x 2'	24" x 24" x 2.6"
F-L2X4-FRAME	78631	2' x 4'	48" x 24" x 2.6"

Pendant Mount Cable

F-LED-CABLE 4PK	72710	2 x 2'
F-LED-CABLE 6PK	72712	1' x 4'

Emergency LED Driver

BEL12/12-48V	EL-1248-XXU
--------------	-------------

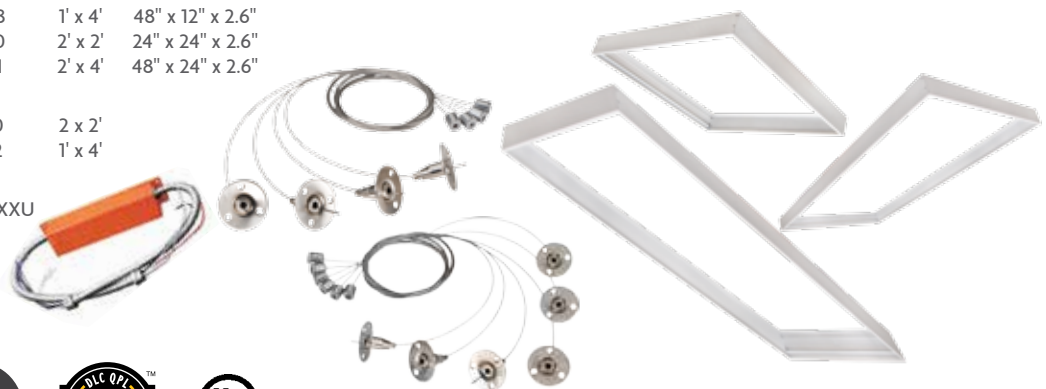



2' x 2'

LED Volumetric Troffers Architectural

Topaz's architectural style LED troffers are a high performance, optically efficient replacement to traditional fluorescent troffers. The aesthetically appealing design has been engineered to perform, delivering up to 110 lumens per watt (LPW) with a glare-free lens ideal for new construction or remodeling of commercial facilities. These troffers are DLC 4.1 Qualified and are available with standard 0-10V dimming. Perfect for offices, hospitals, schools and commercial applications.



2' x 4'

Features

- Architectural modern style with glare-free lens
- Center LED illumination with angled volumetric features for exceptional light distribution
- DLC 4.1 Qualified (4000K, 5000K) providing 110 LPW
- Compatible with 0-10V dimmers or control systems
- New construction or Retrofit for T-Grid installations
- Optional emergency backup available provides 90 minutes of temporary lighting

Item #	Order Code	Size (ft)	Volts	Watts	Lumens	LPW	CCT (Kelvin)	CRI	L70 Life	Beam Angle	Dimmable	DLC
2' x 2'												
F-VTA22/40/835/D	70934	2' x 2'	120-277V	40	4,000	100	3500	80	50,000	90°	0-10V	Pending
F-VTA22/40/840/D	70935	2' x 2'	120-277V	40	4,400	110	4000	80	50,000	90°	0-10V	Y
F-VTA22/40/850/D	70936	2' x 2'	120-277V	40	4,400	110	5000	80	50,000	90°	0-10V	Y
2' x 4'												
F-VTA24/65/835/D	70937	2' x 4'	120-277V	65	6,500	100	3500	80	50,000	90°	0-10V	Pending
F-VTA24/65/840/D	70938	2' x 4'	120-277V	65	7,150	110	4000	80	50,000	90°	0-10V	Y
F-VTA24/65/850/D	70939	2' x 4'	120-277V	65	7,150	110	5000	80	50,000	90°	0-10V	Y





2' x 2'

LED Volumetric Troffers Center Basket

Topaz's volumetric ARC style LED troffers are a high performance, optically efficient replacement to traditional fluorescent. The aesthetically appealing curved lens fills the room with unobstructed light. Engineered to perform, the glare-free lens delivers up to 130 LPW. These fixtures are ideal for new construction or remodeling of commercial facilities. DLC 4.1 Premium Qualified and with standard 0-10V dimming, these troffers are perfect for offices, hospitals, schools and commercial applications.



2' x 4'

Features

- Heavy duty steel construction with gloss white enamel finish
- Center LED illumination with ARC shape volumetric features for exceptional light distribution
- DLC 4.1 Premium Qualified providing up to 130 LPW
- Compatible with 0-10V dimmers or control systems
- New construction or retrofit for T-Grid installations
- Optional emergency backup available provides 90 minutes of temporary lighting
- Ideal for use in offices, schools, hospitals and other commercial applications

Item #	Order Code	Size (ft)	CCT (Kelvin)	Volts	Watts	Lumens	LPW	CRI	Avg. Rated Life	Beam Angle	Dimmable	DLC
2' x 2'												
F-VTC22/30/835/D	72741	2' x 2'	3500	120-277V	30	3,750	125	80	50,000	110°	0-10V	Y
F-VTC22/30/840/D	72742	2' x 2'	4000	120-277V	30	3,800	130	80	50,000	110°	0-10V	Y
F-VTC22/30/850/D	72743	2' x 2'	5000	120-277V	30	3,900	130	80	50,000	110°	0-10V	Y
2' x 4'												
F-VTC24/45/835/D	72745	2' x 4'	3500	120-277V	45	5,625	125	80	50,000	110°	0-10V	Y
F-VTC24/45/840/D	72746	2' x 4'	4000	120-277V	45	5,700	130	80	50,000	110°	0-10V	Y
F-VTC24/45/850/D	72747	2' x 4'	5000	120-277V	45	5,850	130	80	50,000	110°	0-10V	Y





LED Linear 36W Luminaire

The Topaz LED linear 36W luminaire is a new generation of eco-friendly LED linear lights. With 4,400 lumens achieving over 120 lumens per watt, this lamp offers exceptional light output, illumination and energy-savings. Ideally suited for commercial applications including offices, classrooms, garages, hallways, health care and storage facilities, it can easily be surface mounted or suspended, providing additional savings in time and labor costs. UL Listed, DLC Qualified, and rated for 50,000 hours providing virtually maintenance-free service. Standard 0-10V dimming capability and leads the industry with a 5-year warranty.



Features

- Compact and stylish design
- High efficiency 120 lumens/watt
- >80 CRI
- UL, DLC, FCC
- Surface or suspended mount
- 0-10V dimmable
- Universal voltage (100-277V)
- 5-Year limited warranty

Item #	Order Code	Watts	Volts	CRI	CCT (Kelvin)	Lumens	Avg. Rated Life	MOL	DLC	Dimmable
F-LED/4/36W/40/D	79858	36	100-277V	>80	4000	4,400	50,000	47.3"	Y	0-10V



LED Linear Strip and Wrap

Topaz's Linear LED Wrap-Around and Strip Luminaires are the best energy efficient alternative solution for linear fluorescent fixtures. Standard size of 4 feet and designed to open up the room and distribute light spaciouly along both the vertical and horizontal work space. Provides suitable light without any of the maintenance issues associated with fluorescent tubes and ballasts. The Superior LED technology delivers consistent color and CRI for uniform and comfortable lighting. Installation is quick and simple when mounting onto the surface of the ceiling. Constructed with a durable steel housing body and LED lifetime rating of at least 50,000 hours.



Features

- Replacement for 2x32W T8
- 131 Lumens per watt (LPW)
- 120° Beam angle
- Steel housing with UV resistant powder coat finish
- 0-10V dimmable
- 5-Year limited warranty
- Ideal for retail, supermarket, industrial/warehouses, government, hospitals, school/institutions

Linear Strip (Available June 2017)

Item #	Order Code	Watts	Volts	CRI	CCT (Kelvin)	Total Lumens	Avg. Rated Life (L70)	MOL	DLC	Dimmable
F-L4/40W/40K/D	74191	40	100-277V	80	4000	5,240	50,000	48.35"	Pending	0-10V
F-L4/40W/50K/D	74192	40	100-277V	80	5000	5,240	50,000	48.35"	Pending	0-10V





Features

- Replacement for 2x32W T8
- 100 Lumens per watt (LPW)
- 120° Beam angle
- Steel housing with UV resistant powder coat finish
- Chain or surface mount
- Equipped with heat resistant prismatic lens
- 5-Year limited warranty
- Ideal for retail, supermarket, industrial/warehouses, government, hospitals, school/institutions

Linear Wrap (Available June 2017)

Item #	Order Code	Watts	Volts	CRI	CCT (Kelvin)	Lumens	Avg. Rated Life (L70)	MOL	DLC	Dimmable
F-LWRAP/42W/40K	74193	42	100-277V	80	4000	4,200	50,000	47.1"	Y	-
F-LWRAP/42W/50K	74194	42	100-277V	80	5000	4,200	50,000	47.1"	Y	-





LED Linear High Bay

Our Linear High Bay offers high performance at a great value. The linear high bay is a simple, streamlined design for replacement of fluorescent or HID high bay luminaires. This 4 foot linear high bay will save up to 75% power, delivers 20K lumens and is DLC qualified. Suitable for mounting heights up to 25 feet and equipped with hook and chains for mounting. Offered with standard universal voltage 120-277VAC or 480VAC and can be used with standard high bay motion sensors.



Features

- Replacement for 400W metal halide fixture
- 125 Lumens per watt (LPW)
- 0-10V Dimmable*
- Mounting includes V hook and 36" chain
- Stem, chain or pendant mount
- Steel housing with UV resistant powder coat finish
- Equipped with heat resistant clear acrylic lens
- 5-Year limited warranty

Optional Accessory



OCCUPANCY SENSOR

Item #: WD-OS
Order Code: 72700

Item #: WD-OS/480V
Order Code: 75100

Item #	Order Code	Watts	Volts	CRI	CCT (Kelvin)	Lumens	Avg. Rated Life (L70)	MOL	DLC	Dimmable
F-LHB160/50K/UNV	72726	160	100-277VAC	>70	5000	20,060	50,000	47.2"	Y	0-10V
F-LHB160/50K/480V	72724	160	480V	>70	5000	20,060	50,000	47.2"	Y	0-10V

*Dimming with standard 0-10V dimmer, such as Leviton IP710, DS710 or Lutron DVSTV



LED UFO High Bay Lighting

Upgrade your facility in style with Topaz's UFO style High Bay LED luminaires. Compact, lightweight for easy install and suitable for up to 25 foot mounting heights. DLC premium qualified and deliver approximately 19K lumens. The UFO is offered in two styles; an economical version or in high ambient temperature. Perfect for warehouses, gymnasiums and production assembly areas.



Features

- Replacement for 400W metal halide fixture
- Suitable for ambient temperature of -40 to 104°F
- 130 Lumens per watt (LPW)
- Ring mount included for chain or hook installation
- 0-10 Dimmable
- Polycarbonate impact resistant lens
- Material AL1070
- Includes 6 ft power and low voltage cable
- 110° beam angle
- 5-Year limited warranty

High Bay

Item #	Order Code	Watts	Volts	CRI	CCT (Kelvin)	Lumens	Avg. Rated Life (L70)	MOL	DLC	Dimmable
F-LUHB/150/50K	74130	150	100-277V	>80	5000	19,500	50,000	12.8"	Y	0-10V





Features

- Suitable for high temperature applications up to 140°F
- Suitable for food service and NSF certified
- Built-in cooling fins provide maximum heat dissipation
- Replacement for 400W metal halide fixture
- 127 Lumens per watt (LPW)
- Hook mount standard for ease of installation
- Polycarbonate heat and impact resistant lens
- Motion sensor version HTS available
- 5-Year limited warranty

High Bay - High Ambient Temperature (Available June 2017)

Item #	Order Code	Watts	Volts	CRI	CCT (Kelvin)	Lumens	Avg. Rated Life (L70)	MOL	DLC	Dimmable
F-LUHB150/50/HT	74132	150	100-277V	70	5000	19,113	50,000	18"	Pending	0-10V
F-LUHB150/50/HTS	74138	150	100-277V	70	5000	19,113	50,000	18"	Pending	0-10V
F-LUHB150/50/HT/480V	74137	150	480V	70	5000	19,113	50,000	18"	Pending	0-10V
F-LUHB150/50/HTS/480	74139	150	480V	70	5000	19,113	50,000	18"	Pending	0-10V



LED Residential Flush Mount Fixtures

Topaz's residential/multi-family flush mount ceiling fixtures are the perfect choice for illuminating hallways, bedrooms, kitchen, utility rooms and closets. Available in several attractive designs and finishes, these fixtures are an attractive and energy efficient choice over incandescent or compact fluorescent fixtures. LED flush mounts are ENERGY STAR Listed, and available in sizes of 6 inch through 14 inch in diameter.



F-FM11/15/FN/G/30/BN



F-FM11/15/RN/P/30/WH



F-FM10/15/DC/P/30/BN



F-FM12/20/DC/P/30/BN

F-FM14/22/DC/P/30/BN

F-FM8/12/RN/P/30/WH

F-FM6/10/RN/P/30/WH

F-FM11/15/TL/G/30/BN

F-FM11/15/TL/G/30/WH

Features

- Modern and attractive design offered in several finishes and lens options
- Suitable for residential and multi-unit settings
- New construction or replacement and compatible with standard dimming controls*
- Available in 3000K CCT and 80 CRI
- Ideal for use in hallways, kitchens, bedrooms in residential, hospitality and multi-unit complexes

*Compatible with standard forward phase line voltage dimmers. For best results use a dimmer that is designed for LED. For a complete list of recommended dimmers visit www.topaz-usa.com.

Item #	Order Code	Finish	Watts	Volts	CRI	CCT (Kelvin)	Lumens	MOD	Avg. Rated Life	ENERGY STAR	Dimmable	Incand. Equiv.
F-FM6/10/RN/P/30/WH	79013	White Polycarbonate	10	120V	80	3000	600	6"	50,000	Y	Y	60W
F-FM8/12/RN/P/30/WH	79015	White Polycarbonate	12	120V	80	3000	800	8"	50,000	Y	Y	75W
F-FM11/15/RN/P/30/WH	79004	White Polycarbonate	15	120V	80	3000	1,100	11"	50,000	Y	Y	100W
F-FM11/15/TL/G/30/WH	79024	White Frosted Glass, Twist Lock	15	120V	80	3000	1,000	11"	50,000	Y	Y	75W
F-FM11/15/TL/G/30/BN	79006	Brushed Nickel Frosted Glass, Twist Lock	15	120V	80	3000	1,000	11"	50,000	Y	Y	75W
F-FM11/15/FN/G/30/BN	79009	Brushed Nickel Frosted Glass	15	120V	80	3000	850	11"	50,000	Y	Y	100W
F-FM10/15/DC/P/30/BN	79021	Brushed Nickel Polycarbonate	15	120V	80	3000	1,100	10"	50,000	Y	Y	100W
F-FM12/20/DC/P/30/BN	79012	Brushed Nickel Polycarbonate	20	120V	80	3000	1,500	12"	50,000	Y	Y	(2) 60W
F-FM14/22/DC/P/30/BN	71002	Brushed Nickel Polycarbonate	22	120V	80	3000	1,540	14"	50,000	Y	Y	(2) 60W





6"
SDL6

LED Surface Mount Disk Lights

An easy-to-install downlight solution for new construction as well as retrofit applications, Topaz's surface mount LEDs are offered in standard 4" or 6" sizes and are designed to be mounted to most standard 4" J-boxes. Perfect for residential or commercial applications including bathrooms, closets, storage areas, hallways and living areas, they offer exceptional color rendering of 90 CRI and are available in 3000K and 4000K color temperatures. Dimmable down to 5% with standard incandescent or LED style leading edge dimmers, their optical design provides a wide beam greater than 105° with low glare. With a life rating of at least 36K hours, these fixtures greatly minimize the cost of ownership through reduced maintenance and lower utility costs. California Title 24 and ENERGY STAR Listed, these fixtures are wet location rated.



4"
SDL4

Features

- Surface mount to most 4" J-boxes
- Driver-on-board technology eliminates an external power supply
- Power factor >.99
- Dimmable down to 5%
- Suitable for damp or wet locations for shower or outdoor enclosed locations
- Color temperature 3000K and 4000K
- Up to 75% energy-savings over traditional incandescent sources
- Select models California JA8-2016 Compliant*

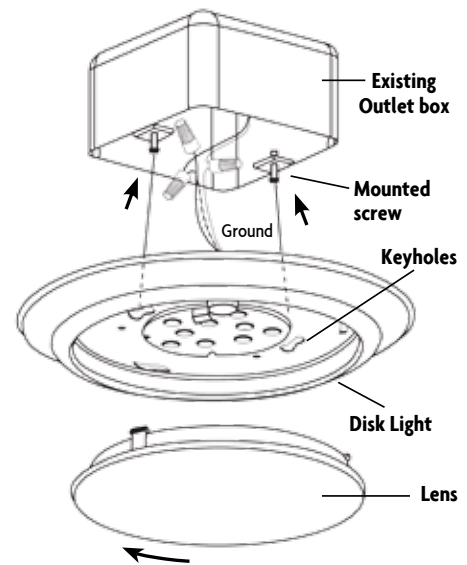

Item #	Order Code	Finish	Watts	Volts	CRI	CCT (Kelvin)	Lumens	Beam Angle	CBCP (cd)	MOD	Avg. Rated Life (L70)	ENERGY STAR	Dimmable	CA JA8
SDL4/12/930/D	70681	White	12	120V	90	3000	840	105°	223	5.8"	50,000	Y	Y	-
SDL4/12/940/D	70682	White	12	120V	90	4000	910	105°	223	5.8"	50,000	Y	Y	-
SDL6/15/930/D	70685	White	15	120V	90	3000	1,050	105°	342	7.4"	50,000	Y	Y	-
SDL6/15/940/D	70686	White	15	120V	90	4000	1,090	105°	342	7.4"	50,000	Y	Y	-
SDL4/12/930/D/CC*	74176	White	12	120V	90	3000	834	110°	223	5.9"	36,000	Y	Y	Y
SDL4/12/940/D/CC*	74177	White	12	120V	90	4000	834	110°	223	5.9"	36,000	Y	Y	Y
SDL6/15/930/D/CC*	74174	White	15	120V	90	3000	1,070	105°	342	7.4"	36,000	Y	Y	Y
SDL6/15/940/D/CC*	74175	White	15	120V	90	4000	1,070	105°	342	7.4"	36,000	Y	Y	Y



LED Retrofit Units

Topaz provides a high performance and easy-to-install retrofit solution for standard recessed housings. Models are available in 4" and 6" sizes for downlighting or directional applications. The units are dimmable down to 5% for optimal control and offer 90+ CRI for exceptional color rendering in 2700K-5000K. Constructed with advanced thermal management and optics, each unit is equipped with a power connector system for ease of installation. All units are ENERGY STAR and UL Listed for wet and/or damp locations. Topaz LED retrofit units are designed for reduced cost of ownership through lower energy and maintenance costs and have a life rating up to 50K hours.



Square

Item #	Order Code	Size	Voltage	Watts	CCT (Kelvin)	CRI	Lumens	Avg. Rated Life	ENERGY STAR	Dimmable	Wet Location
RTL/43SQ/WH/90/D	79715	4"	120V	10	3000	>90	715	50,000	Y	Y	Y
RTL/44SQ/WH/90/D	79717	4"	120V	10	4000	>90	760	50,000	Y	Y	Y
RTL/63SQ/WH/90/D	79263	6"	120V	16	3000	>90	1,000	50,000	Y	Y	Y
RTL/64SQ/WH/90/D	79265	6"	120V	16	4000	>90	1,100	50,000	Y	Y	Y





4"



5"/6"

Features

- Direct retrofit for existing trim/bulb combinations
- 90+ CRI models for exceptional color rendering
- Easy installation: unit screws into socket
- Dimmable down to 5% of total light output
- Available in different sizes and color temperatures for every application
- ENERGY STAR Listed
- Contains NO mercury

Gimbal

Item #	Order Code	Size	Voltage	Watts	CCT (Kelvin)	CRI	Lumens	Avg. Rated Life	ENERGY STAR	Dimmable	Damp Location
RTL/437WH/90/D	79707	4"	120V	8	3000	>90	620	50,000	Y	Y	Y
RTL/447WH/90/D	79709	4"	120V	8	4000	>90	690	50,000	Y	Y	Y
RTL/637WH/90/D	79711	5"/6"	120V	12	3000	>90	1,025	50,000	Y	Y	Y
RTL/647WH/90/D	79713	5"/6"	120V	12	4000	>90	1,100	50,000	Y	Y	Y



LED Retrofit Units



Baffles

Item #	Order Code	Size	Voltage	Watts	CCT (Kelvin)	CRI	Lumens	Avg. Rated Life	ENERGY STAR	Dimmable	Wet Location
RTL/423WH/90/D	79706	4"	120V	11	2700	>90	625	50,000	Y	Y	Y
RTL/433WH/90/D	79719	4"	120V	11	3000	>90	750	50,000	Y	Y	Y
RTL/443WH/90/D	79721	4"	120V	11	4000	>90	765	50,000	Y	Y	Y
RTL/623WH/90/D	79710	5"/6"	120V	15	2700	>90	1,020	50,000	Y	Y	Y
RTL/633WH/90/D	79723	5"/6"	120V	16	3000	>90	1,155	50,000	Y	Y	Y
RTL/643WH/90/D	79725	5"/6"	120V	15	4000	>90	1,250	50,000	Y	Y	Y





Smooth Eco

Item #	Order Code	Size	Voltage	Watts	CCT (Kelvin)	CRI	Lumens	Avg. Rated Life	ENERGY STAR	Dimmable	Damp Location
RTL/420WH/ECO/D	70940	4"	120V	10	2700	>90	600	35,000	Y	Y	Y
RTL/430WH/ECO/D	70941	4"	120V	10	3000	>90	620	35,000	Y	Y	Y
RTL/440WH/ECO/D	70942	4"	120V	10	4000	>90	645	35,000	Y	Y	Y
RTL/450WH/ECO/D	70643	4"	120V	10	5000	>90	670	35,000	Y	Y	Y
RTL/620WH/ECO/D	70687	5"/6"	120V	12	2700	>90	720	35,000	Y	Y	Y
RTL/630WH/ECO/D	70688	5"/6"	120V	12	3000	>90	740	35,000	Y	Y	Y
RTL/640WH/ECO/D	79347	5"/6"	120V	12	4000	>90	770	35,000	Y	Y	Y
RTL/650WH/ECO/D	79370	5"/6"	120V	12	5000	>90	800	35,000	Y	Y	Y



LED New Construction/ Remodel Housings

Topaz's new construction and remodel LED recessed housings are the perfect choice for LED trim kits. Offered in both 4" and 5/6" housing sizes, these line voltage housings are the perfect choice for new and remodel construction. The recessed housings are standard IC rated and Airtight to meet local building code requirements. The housings feature a quick connect for fast install of a wide array of Topaz LED trim kits.



Remodel

Item #	Order Code	Size	Description
RH4/RLED/IC/AT (shown)	79991	4"	IC/AT - Remodel
RH5/RLED/IC/AT	79997	5"	IC/AT - Remodel
RH6/RLED/IC/AT	79993	6"	IC/AT - Remodel

Optional GU24 Socket Adapter:

Item # RTLED/RETRO/GU24
Order Code: 79560



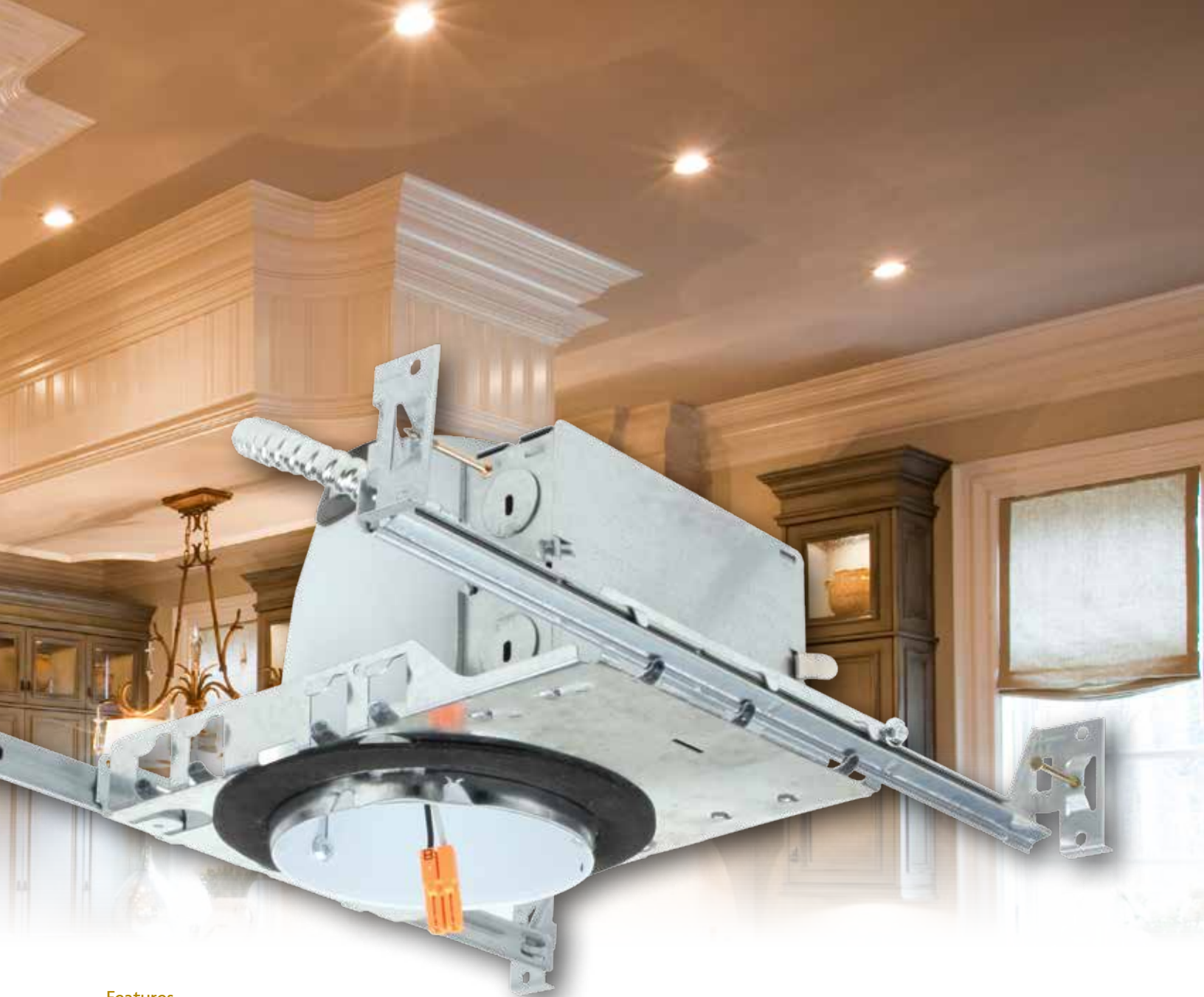

Features

- Steel housing construction
- IC Rated and Airtight to meet local building codes
- Quick connect for ease of connection to LED trim kits
- Available in new and remodel construction

New Construction

Item #	Order Code	Size	Description
RH4/NLED/IC/AT (shown)	79990	4"	IC/AT - New Construction
RH5/NLED/IC/AT	79996	5"	IC/AT - New Construction
RH6/NLED/IC/AT	79992	6"	IC/AT - New Construction

Optional GU24 Socket Adapter:
 Item # RTLED/RETRO/GU24
 Order Code: 79560





LED Outdoor Lighting

The Topaz line of outdoor LED fixtures feature attractive and contemporary designs with the latest advances in LED technology. Constructed of sturdy die-cast aluminum and finished with UV resistant powder coating, our fixtures deliver even more energy-savings compared to traditional lighting and reduce maintenance costs through long life.

With the Topaz speed-to-market, speed-to-innovation approach, our customers always benefit from the latest proven LED technologies at an unbeatable value.





Compact Flood Light

Topaz's small but powerful design for light commercial and residential applications. Highly efficient LED light engine in a compact housing unit fits the bill for smaller scale illumination such as façade, landscape, sign and instant-on security lighting. Enhanced precise optic control offers a superior light output that is glare-free. Easily installs to a standard J-box with 1/2" NPS swivel fitter for ground or wall mounting.

Our new UL Listed Compact Flood Light is engineered to maximize light output while offering a highly energy efficient operation. IP65 rated to withstand damaging weather conditions without performance interruption.



F-FLC-20WLED

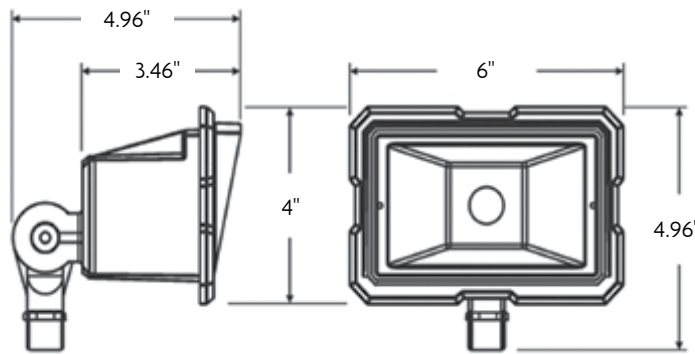

Features

- Advanced thermal management ensures a longer LED and driver lifespan
- Built to last, die-cast aluminum construction with UV stabilized, powder coat finish that withstands inclement weather conditions
- 50K hours operational life rating translates into 10 YEARS of maintenance free usage
- High quality lighting properties with less energy usage—superior LED, optical and thermal engineering provides >90 LPW and offers up to an 80% savings in energy use versus comparable HID luminaires or halogens
- Strong, tempered glass lens with integral glare shield produces glare-free, natural light
- PF >0.9 and THD <15%

Markets

- Commercial and residential

Applications

- General illumination of walkways, landscape lighting, building façades, security areas

Item #	Order Code	Input Voltage	Input Current Amps	Input Power Watts	Lumens	CCT (Kelvin)	CRI	IES Type Distribution	Equivalent Wattage*
F-FLC-20WLED	79795	120VAC	0.17	20	1,861	5000K	>70	II	200W Halogen/70W-100W MH

*Equivalent wattage dependent on fixture, reflectance and lumen maintenance of lamp



Low Profile Flood Lights

Topaz's low profile flood lights are perfect for landscape lighting and bright enough to illuminate building façades. These powerful flood lights deliver a wide angle NEMA 7Hx7V light distribution providing maximum light spread when lighting signs and washing walls or façades. Trunnion mounted flood makes it easy to replace wall mount applications for walkway illumination, or areas requiring security lighting. These fixtures are DLC qualified and are an economical option to replace standard HID floods saving up to 75% energy and providing up to 50,000 hours of life.





F-FL-13/50K/KN/BZ



F-FL-50/50K/TR/BZ

F-FL-30/50K/KN/BZ

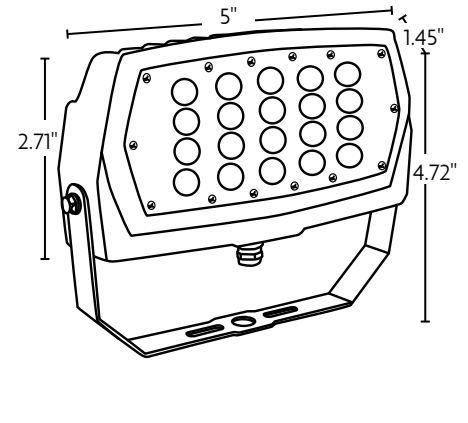
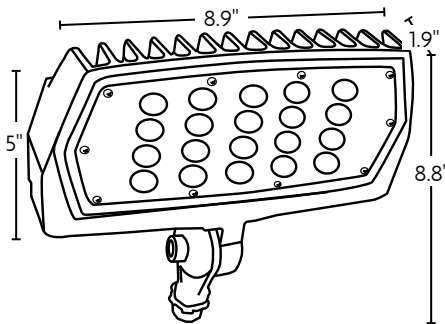
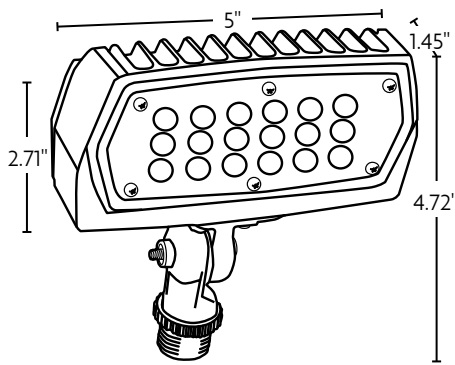

Features

- Built to last, die-cast aluminum construction with UV stabilized, powder coat finish that withstands inclement weather conditions
- Bronze finish
- Wide beam, NEMA 7Hx7V distribution
- Shock and impact resistant polycarbonate lens
- Perfect for applications requiring wide coverage
- Over 110 lumens per watt
- 1/2 NPS swivel mount or trunion mount

Applications

- Building façade, security, landscape, signs and display illumination
- Trunion mount for wall mount applications

(Available June 2017)

Item #	Input Order Code	Input Voltage	Input Current Amps	Power Watts	Lumens	CCT (Kelvin)	CRI	NEMA Type Distribution	Equivalent Wattage*	DLC
F-FL-13/50K/KN/BZ	74185	120-277V	0.40-0.17	13	1,474	5000K	80	7Hx7V	50-70W MH	Pending
F-FL-30/50K/KN/BZ	74183	120-277V	0.24-0.10	30	3,307	5000K	80	7Hx7V	70-150W MH	Pending
F-FL-50/50K/TR/BZ	74181	120-277V	0.10-0.04	50	5,562	5000K	80	7Hx7V	150-250W MH	Pending

*Equivalent wattage dependent on fixture, reflectance and lumen maintenance of lamp



Architectural Wall Pack/Flood Lights

Topaz's Architectural Wall Pack/Flood Light series combine style with high performance. With a housing design that optimizes the LED performance, these models offer an architecturally appealing look that also provides the best optic, thermal and LED design for enhanced performance versus traditional fixtures.

Our IP65 rated fixtures are designed for use in shopping malls, office complexes, hotels and parks where exceptional light output is required to ensure continuous ease of movement and safety at any hour, regardless of the forecast. With five different mounting options including trunion, large slip fit, knuckle mount and up and down wall mount, this high performing, versatile series can be effortlessly installed in almost any location.

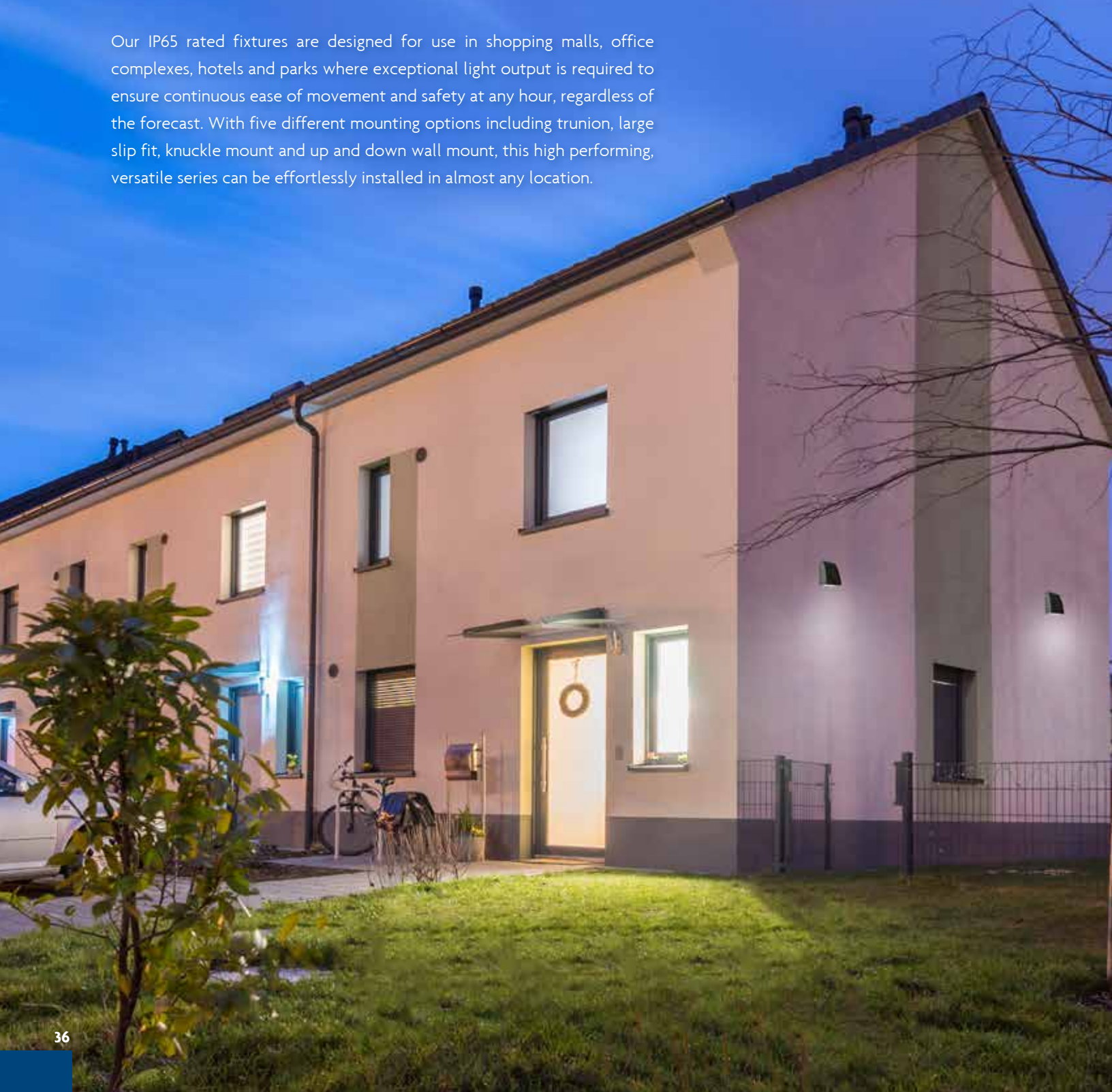

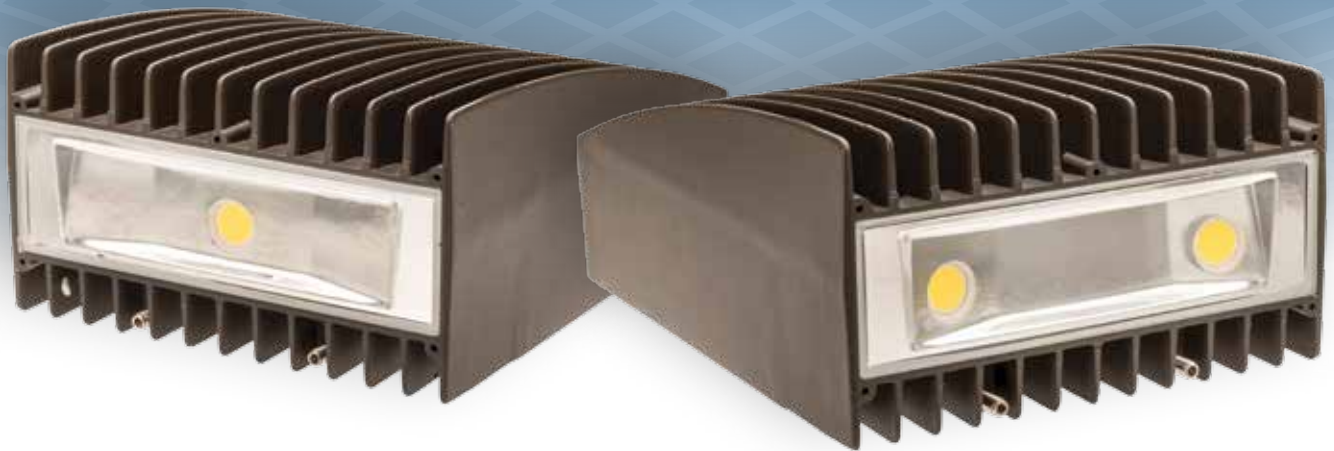

F-FL/WP-40WLED

F-FL/WP-60WLED



(Mounting brackets are sold separately)

Features

- Advanced thermal management ensures a longer LED and driver lifespan
- Built to last, die-cast aluminum construction with UV stabilized, powder coat finish that withstands inclement weather conditions
- 50K hours operational life rating translates into 10 YEARS of maintenance free usage
- High quality lighting properties with less energy usage—superior LED, optical and thermal engineering provides >100 LPW and offers up to an 80% savings in energy use versus comparable HID luminaires
- Strong, tempered glass lens with integral glare shield produces a focused throw forward, glare-free natural light
- Can be used with photocells for additional light control

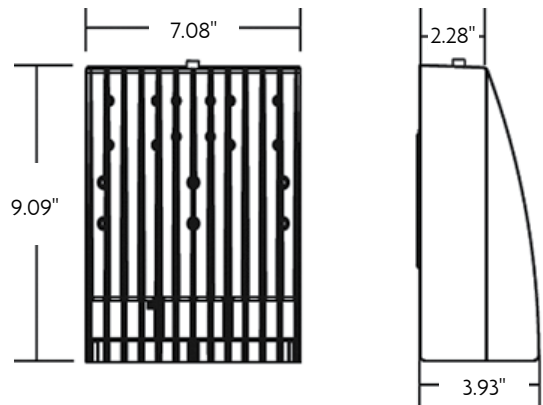

Markets

- Commercial and light industrial

Applications

- General illumination of walkways, areas of ingress, building façades, security areas

Item #	Order Code	Input Voltage	Input Current Amps	Input Power Watts	Lumens	CCT (Kelvin)	CRI	IES Type Distribution	Equivalent Wattage*	DLC
F-FL/WP-40WLED	79797	100-277V	0.36 - 0.15	40	4,211	5000K	>70	II	200W MH	Y
F-FL/WP-60WLED	79798	100-277V	0.54 - 0.22	60	6,659	5000K	>70	II	250W MH	Y
F-FL-KNMOUNT	70660									
F-FL-SFMOUNT	70662									
F-FL-TRMOUNT	70664									

*Equivalent wattage dependent on fixture, reflectance and lumen maintenance of lamp



Traditional Wall Packs

For general area lighting, Topaz's LED Wall Packs are a highly efficient solution. These lamps provide a long-lasting, cost-efficient option to high pressure sodium, metal halide and other traditional lights. Designed with a prismatic lens, these fixtures make the most of their highly efficient LEDs and create a widely distributed light to illuminate large areas. Constructed with a rugged, powder coated die-cast aluminum housing and featuring an operating expectancy of greater than 50,000 hours, these lights can last for years in all types of environments including warehouses, factories, restaurants, shopping areas and parks. The housing is designed to be mounted on junction boxes or direct wall mounts with feed-through conduit access for easy installation. An optional photocell can be installed for additional energy control.



F-WP-90LED/50K
F-WP-135LED/50K

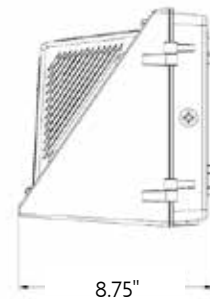
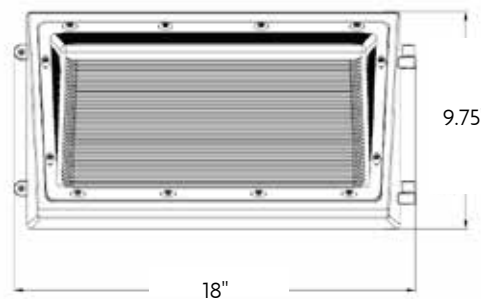



F-WPS-29WLED



F-WP-45LED/50K
F-WP-70LED/50K

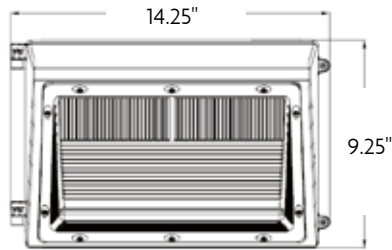
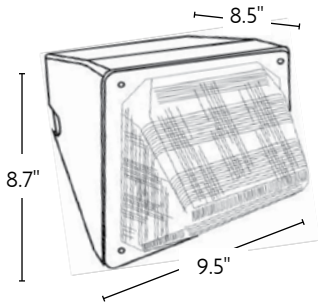

Features

- Die-cast housing with UV resistant powder coat finish
- High impact polycarbonate diffuser
- -40°C to 40°C ambient rating
- Universal voltage 100-277V
- THD: <20%; Power Factor: >0.9
- Life: >50K hours (L70)
- Photocell included with 45W, 70W, 90W and 135W wall pack



EMERGENCY LED DRIVER

(Sold separately)



WD-SP

(Sold separately)



F-WP-PHOTOCELL

(Sold separately)

Markets

- Outdoor commercial and residential

Can be used with 45W, 70W, 90W and 135W wall packs

Item #	Code	Input Voltage	Input Current Amps	Input Power Watts	Lumens	CCT (Kelvin)	CRI	IES Type Distribution	Equivalent Wattage*	DLC
F-WPS-29WLED	78790	100-277V	0.3 - 0.12	29	2,600	5000K	>70	IV	100W MH	-
F-WP-45LED/50K	74481	100-277V	0.17-0.38	45	5,300	5000K	>70	IV	175W MH	Y
F-WP-70LED/50K	74483	100-277V	0.26-0.59	70	8,100	5000K	>70	IV	250W MH	Y
F-WP-90LED/50K	74485	100-277V	0.34-0.75	90	11,200	5000K	>70	IV	320W MH	Y
F-WP-135LED/50K	74487	100-277V	0.50-1.13	135	16,400	5000K	>70	IV	400W MH	Y

BEL12/12-48V EL-1248-XXU Emergency LED Driver

WD-SP 79200 Surge Protector

F-WP-PHOTOCELL 72767 Photocell (120V)

*Equivalent wattage dependent on fixture, reflectance and lumen maintenance of lamp





Architectural Slim Wall Packs

Topaz's LED adjustable slim wall packs deliver full cutoff or semi cutoff light distribution. The innovative pivoting head design aims the light precisely and adjusts up to 20 degrees for forward throw illumination. Suitable for up to 25 foot mounting for applications including pathways, perimeter lighting and building entryways. Available in 30W, 40W (small), and 70W, 90W (large) with CCT of 5000K and DLC qualified.



F-AWP/30/50K/BZ
F-AWP/40/50K/BZ

F-AWP/70/50K/BZ
F-AWP/90/50K/BZ

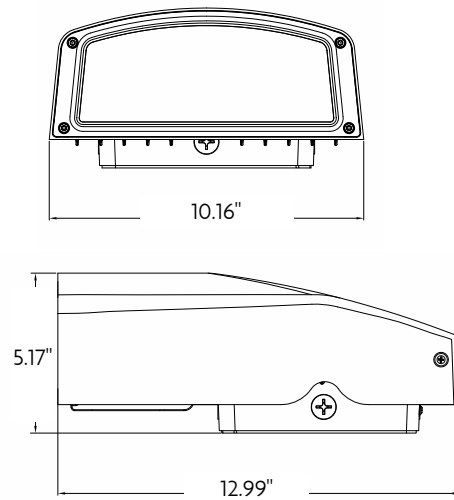
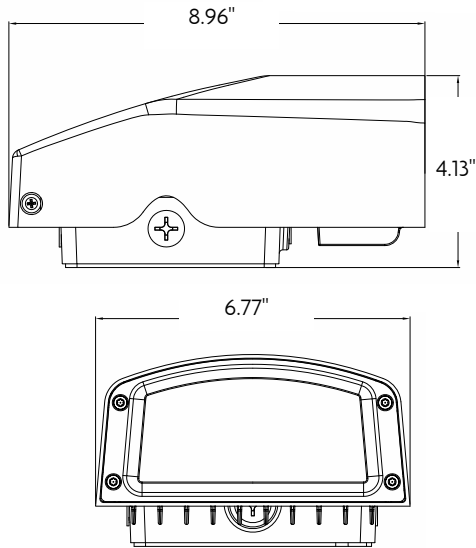

Features

- Adjustable head provides full cutoff and semi cutoff IES type III light distribution
- Light heads adjust up to 20 degrees for greater forward light distribution
- Built in 120-277VAC photocell
- Easy mounting system
- Life rating 50K hours (L70)

Applications

- Security, pathway and perimeter lighting, building entryways and walkways

Item #	Code	Input Voltage	Input Current Amps	Input Power Watts	Lumens	CCT (Kelvin)	CRI	IES Type Distribution	Equivalent Wattage*	DLC
F-AWP-30/50K/BZ	70743	100-277V	0.28-0.12	30	3,000	5000K	70	III	100W MH	Y
F-AWP-40/50K/BZ	70744	100-277V	0.37-0.16	40	4,500	5000K	70	III	175W MH	Y
F-AWP-70/50K/BZ	70745	100-277V	0.65-0.28	70	7,800	5000K	70	III	250W MH	Y
F-AWP-90/50K/BZ	70746	100-277V	0.83-0.36	90	10,500	5000K	70	III	320W MH	Y

*Equivalent wattage dependent on fixture, reflectance and lumen maintenance of lamp





Full Cutoff Wall Pack

Topaz's LED Full Cutoff Wall Pack is a highly efficient lighting solution that provides a long-lasting, energy-saving and cost-efficient alternative to high pressure sodium, metal halide and other traditional lights. The environmentally friendly, full cutoff wall mount design utilizes highly reliable, high power LEDs to minimize energy usage while maximizing directed light distribution, eliminating any upward illumination. Constructed with a rugged, powder coated die-cast aluminum housing and featuring an operating expectancy of greater than 50,000 hours, this fixture is sure to last for years and is suitable for outdoor applications including warehouses, factories, restaurants, shopping areas and parks. An optional photocell can be installed for additional energy control.



F-WPM-40WLED-FC

Features

- Die-cast housing with UV resistant powder coat finish
- Tempered glass lens
- -20°C to 50°C ambient rating
- Universal voltage 100-277V
- THD: <20%; Power Factor: >0.9
- Life: >50K hours (L70)
- Dark sky compliant

Markets

- Outdoor commercial and residential

Applications

- Warehouses
- Factories
- Loading docks

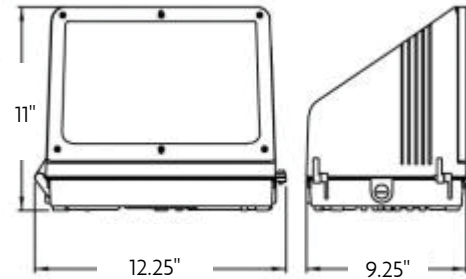

Item #	Order Code	Input Voltage	Input Current Amps	Input Power Watts	Lumens	CCT (Kelvin)	CRI	IES Type Distribution	Equivalent Wattage*	DLC
F-WPM-40WLED-FC	78804	100-277V	0.4 - 0.14	37	3,000	4700K	>70	VS	175W MH	Y

*Equivalent wattage dependent on fixture, reflectance and lumen maintenance of lamp



Small Wall Packs

Topaz's LED Small Wall Packs are a compact light source with a diffused prismatic lens providing uniform and efficient lighting. As an energy-saving and long life alternative to traditional light sources, they deliver incredible efficiency without sacrificing performance. Rated for greater than 50,000 hours of operation and constructed of rugged die-cast aluminum with a high impact polycarbonate lens, these wall packs are guaranteed to stand up to the harshest of elements for many years. Ideal for outdoor illumination of stairwells, pathways and entryways in commercial and residential settings.





F-WPS-17WLED



F-WPS-17WLED-WH

Features

- Die-cast housing with UV resistant powder coat finish
- High impact polycarbonate diffuser
- -20°C to 50°C ambient rating
- 120VAC, 50/60 Hz
- THD: <20%; Power Factor: >0.9
- Life: >50K hours (L70)
- Photocell included

Markets

- Outdoor commercial and residential

Applications

- Entryways
- Stairwells
- Hallways

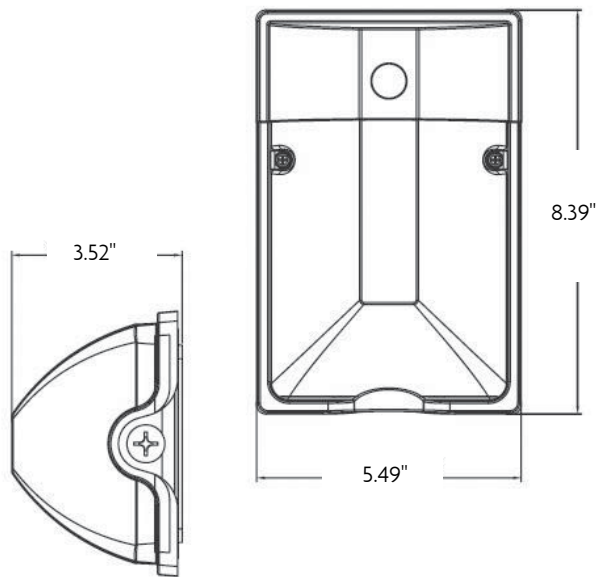

Item #	Order Code	Input Voltage	Input Current Amps	Input Power Watts	Lumens	CCT (Kelvin)	CRI	IES Type Distribution	Equivalent Wattage*	DLC
F-WPS-17WLED	73463	120VAC	0.20	17	1,700	5000K	>80	I	120W Incand., 50W MH	Y
F-WPS-17WLED-WH	73467	120VAC	0.20	17	1,700	5000K	>80	I	120W Incand., 50W MH	Y

*Equivalent wattage dependent on fixture, reflectance and lumen maintenance of lamp





Canopy and Parking Garage Lights

Our ruggedly designed LED Canopy and Parking Garage Lights promote safety and security in outdoor commercial and industrial environments while providing a long-lasting and energy-saving alternative to traditional HID lighting. These low profile fixtures feature a highly reliable LED light engine and an impact resistant polycarbonate optical diffuser. Suitable for outdoor or indoor applications, they are the perfect fit for garages, underground passage ways, corridors and fuel stations. Additionally, the low profile design offers an architectural appeal and is ideal for applications with limited space. With an expected operating life of greater than 50,000 hours and a 65% energy-savings compared to traditional HID lamps, these fixtures are sure to outlast the competition.



F-CNPY-45WLED-LP F-CNPY-70WLED-LP

Features

- Die-cast housing with UV resistant powder coat finish
- High impact polycarbonate diffuser
- Minimum starting temperature: -25°C
- Universal voltage 100-277V
- Quick mount installation
- THD: <20%; Power Factor: >0.9
- Life: >50K hours (L70)

Markets

- Outdoor and indoor commercial and hospitality

Applications

- Parking garages, stairwells, exterior canopy lighting.
Typically mounts up to 15'. Single gang, 3-1/2" octagonal, 4" square, 4" octagonal junction box

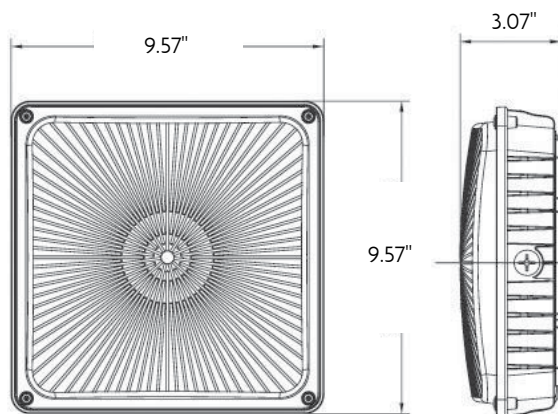

Item #	Order Code	Input Voltage	Input Current Amps	Input Power Watts	Lumens	CCT (Kelvin)	CRI	IES Type Distribution	Equivalent Wattage*	DLC
F-CNPY-45WLED-LP	73464	120-277V	0.52 - 0.2	45	4,050	5000K	>70	VS	175W MH	Y
F-CNPY-70WLED-LP	73465	120-277V	0.80 - 0.3	70	5,900	5000K	>70	VS	250W MH	Y

*Equivalent wattage dependent on fixture, reflectance and lumen maintenance of lamp



Round Canopy Lights

Our round canopies are the perfect alternative to the typical square. With a sleek appearance, frosted lens and powerful lumen output it's the best match to replace HID luminaires. DLC qualified and suitable for garages, perimeter lighting and entryways. Available in 40W and 60W and can be mounted up to 15 feet. The round canopy lights feature an easy mount system for connection to a junction box.

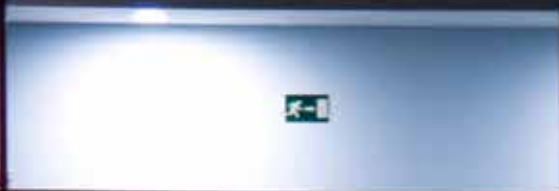



F-CNPY-RND40W/50K-BZ
F-CNPY-RND60W/50K-BZ



F-CNPY-RND40W/50K-WH
F-CNPY-RND60W/50K-WH

Features

- Die-cast housing with impact resistant polycarbonate lens
- Low profile suitable for parking garage, exterior canopies, commercial applications
- Pendant mount or surface mount to J Box
- -40°C to 45C ambient temp
- Universal voltage 100-277V/60Hz
- IES Distribution Type V
- Life: >50K hours (L70)

Applications

- Parking garages, stairwells, exterior canopy lighting.
 Typically mounts up to 15'. Single gang, 3-1/2" octagonal, 4" square, 4" octagonal junction box

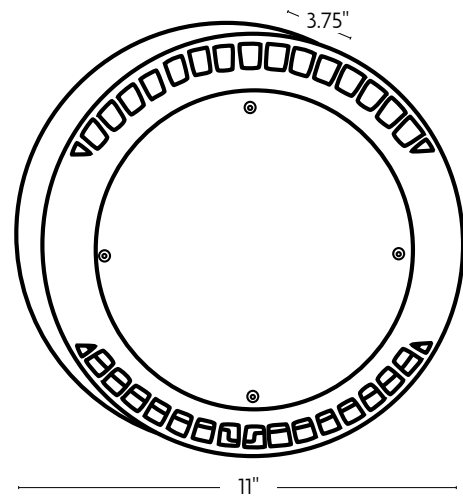

Item #	Order Code	Input Voltage	Input Current Amps	Input Power Watts	Lumens	CCT (Kelvin)	CRI	Equivalent Wattage*	DLC
F-CNPY-RND40W/50K-BZ	70763	120-277V	0.33-0.15	40	3,845	5000K	70	175W MH	Y
F-CNPY-RND40W/50K-WH	70761	120-277V	0.33-0.15	40	3,845	5000K	70	175W MH	Y
F-CNPY-RND60W/50K-BZ	70767	120-277V	0.5-0.22	60	5,770	5000K	70	250W MH	Y
F-CNPY-RND60W/50K-WH	70765	120-277V	0.5-0.22	60	5,770	5000K	70	250W MH	Y

*Equivalent wattage dependent on fixture, reflectance and lumen maintenance of lamp



Dusk-to-Dawn

Utilizing a single source LED, Topaz's Dusk-to-Dawn fixture with its NEMA approved photocell provides prismatic designed light output for any environment. A long-lasting alternative to traditional lights with a life rating of greater than 50,000 hours, this fixture features chip on board (COB) LED technology and advanced thermal management and offers energy-savings of up to 80% compared to typical fixtures. Fabricated with a heavy duty, corrosion resistant cast aluminum housing and designed to be installed on a wall or pole, this fixture is ideal for parking lots, warehouses, farm applications and factory loading docks.





F-D2D-45WLED KIT F-D2D-70WLED KIT

(Also available in gray)

Features

- Die-cast housing with UV resistant powder coat finish
- Highly efficient LED light source up to 110 lumens/watt
- Minimum starting temperature: -25°C
- Full cutoff optical design
- THD: <20%; Power Factor: >0.9
- Life: >50K hours, up to 3X longer than traditional HID sources
- 120-227V photocell included
- Mounting pole and hardware included

Markets

- Outdoor commercial and residential

Applications

- Barn lighting
- Area lighting
- Loading docks
- Parking lots

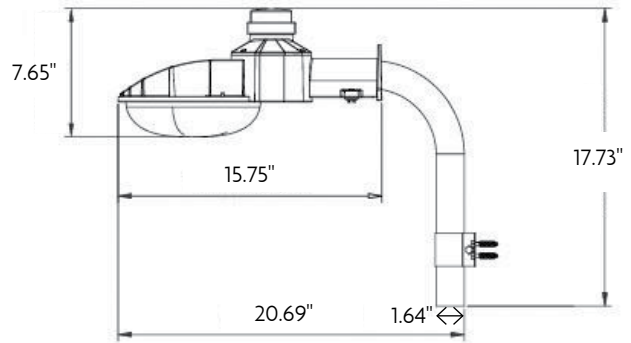

Item #	Order Code	Input Voltage	Input Current Amps	Input Power Watts	Lumens	CCT (Kelvin)	CRI	IES Type Distribution	Equivalent Wattage*	DLC
F-D2D-45WLED KIT	73461	120-277V	0.52 - 0.2	45	5,000	5000K	>70	VS	175W MH	Y
F-D2D-70WLED KIT	73462	120-277V	0.80 - 0.3	70	7,000	5000K	>70	VS	250W MH	Y
F-D2D-70WLED KIT (GRAY)	73470	120-277V	0.80 - 0.3	70	7,000	5000K	>70	VS	250W MH	Y

*Equivalent wattage dependent on fixture, reflectance and lumen maintenance of lamp



Parking Lot/Area Lights

Topaz's Area Lights feature outstanding photometric performance, uniform illumination, low-profile design, high efficacy, long lifespan, and easy installation. The one-piece die-cast aluminum housing with UV resistant powder coat finish offers outstanding corrosion protection. Ideal for use in various commercial environments such as auto dealerships, parking lots, walkways, roadways, campuses, façade lighting, grocery stores and other public areas.





F-ARL/150W/50K/SF



F-ARL/150W/50K/TR



F-ARL/300W/50K/SF

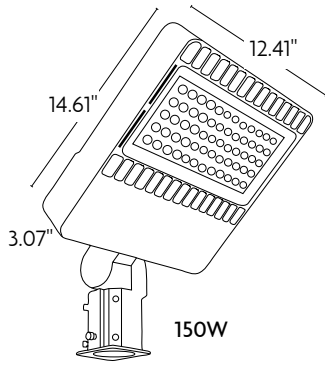

150W

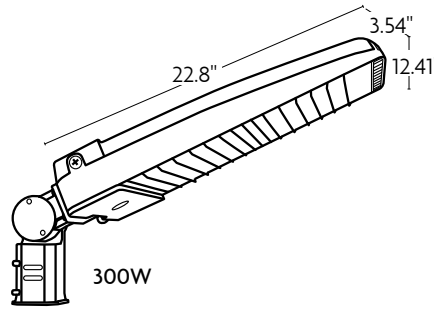

300W



F-ARL/300W/50K/TR

Features

- One piece die-cast aluminum housing with UV resistant polycarbonate optical lens
- 2" slipfitter mounting or trunion mount options
- 130 Lumens per watt (LPW)
- Suitable for mounting heights ranging from 18-36' in area lighting applications
- Silicone rubber included to create a weatherproof seal
- Twist-lock photocell included
- Ambient temperature range: -40°F to 113°F

Applications

- Parking lots, area lighting, illumination of areas of ingress, security lighting



F-FL/PL-ADPT-90DEG



F-FL/PL-POLE MOUNT



F-FL/PL-ADPT-SQ-RND

Item #	Order Code	Input Voltage	Input Current Amps	Input Watts	Lumens	CCT (Kelvin)	CRI	Avg. Rated Life	Equivalent Wattage*	DLC
F-ARL/150W/50K/SF	74470	120-277V	1.39-0.60	150	20,000	5000K	>70	50,000	400W MH	Y
F-ARL/300W/50K/SF	74471	120-277V	2.78-1.20	300	39,000	5000K	>70	50,000	1,000W MH	Y
F-ARL/150W/50K/TR	74474	120-277V	1.39-0.60	150	21,000	5000K	>70	50,000	400W MH	Y
F-ARL/300W/50K/TR	74475	120-277V	2.78-1.20	300	40,000	5000K	>70	50,000	1,000W MH	Y
F-FL/PL-ADPT-90DEG	73380	90° Adapter								
F-FL/PL-ADPT-SQ-RND	73382	4" Square to Round Pole Adapter								
F-FL/PL-POLE MOUNT	74220	4" Pole mounting kit for square or round pole								

*Equivalent wattage dependent on fixture, reflectance and lumen maintenance of lamp





Line Voltage Recessed Downlighting

Topaz's residential/commercial line voltage housings and trims are the perfect choice for new and remodel construction. Available in 4", 5" and 6" diameter openings to accommodate a wide array of trims to complement any style. Offered in both IC and Non-IC rated fixtures to meet local building code requirements. For applications with restricted space, Topaz carries a line of shallow housings as well as housings for sloped ceilings.



4" Line Voltage New Construction Housing

Features

- 50 watt max PAR/R20
- Plaster frame: Galvanized steel construction. Housing can be removed from plaster frame to provide access to the junction box
- Thermal protector: Self resetting thermal protector deactivates fixture if overheating occurs due to improper lamping or misapplied insulation
- UL Listed for damp location
- UL Listed for feed through wiring
- Certified under ASTM-E283 for airtight construction (RH4/N/IC/AT only)

Installation

- Bar hanger: Pre-installed nails easily install in regular or engineered lumber. Bar hangers are adjustable from 13-5/8" to 25" and can be repositioned 90 degree on plaster frame
- Junction box: Listed for through branch circuit wiring. Contains seven 7/8" knockouts and four Romex pryouts with strain relief



Non-IC

Item #: RH4/N

Order Code: 78080



IC Airtight

Item #: RH4/N/IC/AT

Order Code: 79437

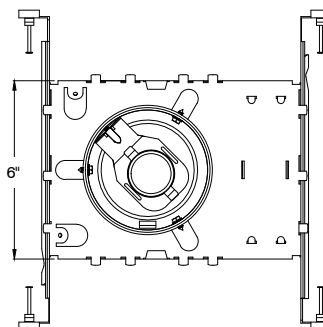
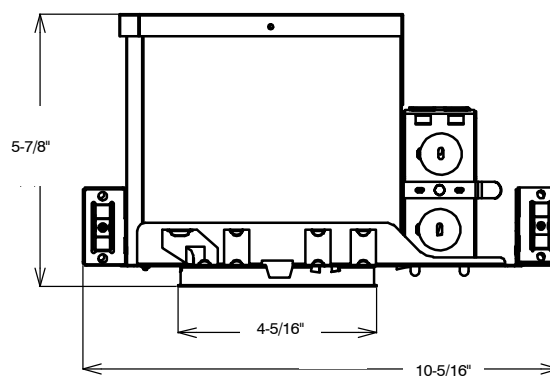
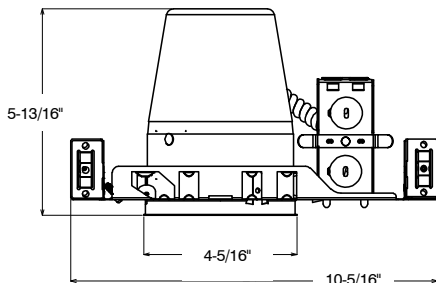
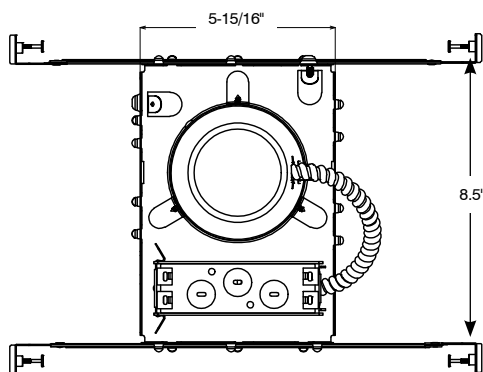

4" Line Voltage Remodel Construction Housing

Features

- 50 watt max PAR/R20
- Thermal protector: Self resetting thermal protector deactivates fixture if overheating occurs due to improper lamping or misapplied insulation
- Remodel clips: Four remodel clips secure housing and accommodates 1/2" and 5/8" ceiling materials
- UL Listed for damp location
- UL Listed for feed through wiring
- Certified under ASTM-E283 for airtight construction

Installation

- Junction box: Listed for through branch circuit wiring. Contains seven 7/8" knockouts and four Romex pryouts with strain relief



Non-IC Airtight

Item #: RH4/R/AT

Order Code: 78280

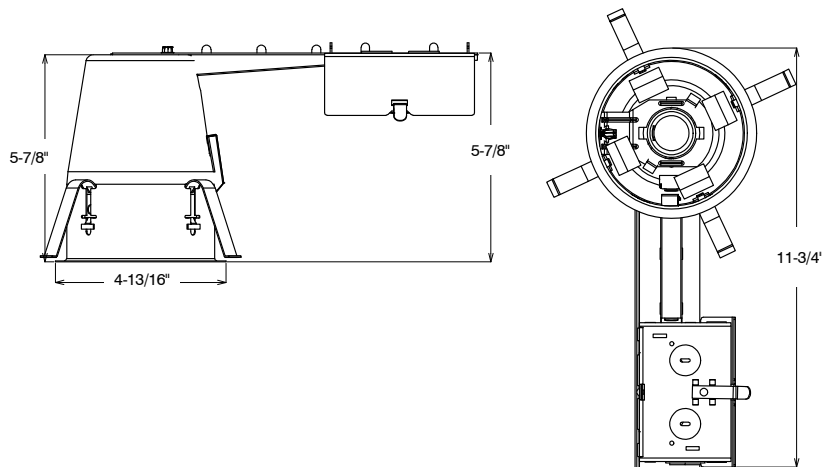

4" Line Voltage Trims



RT400CL/WH
 Clear Reflector with White Ring
 Uses 50W R20, PAR20 Lamps
 Order Code: 77671

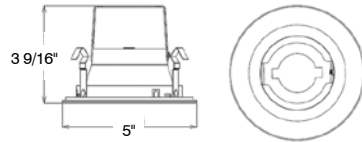

RT401BL/PB
 Black Reflector with Polished Brass Ring
 Uses 50W R20, PAR20 Lamps
 Order Code: 78732

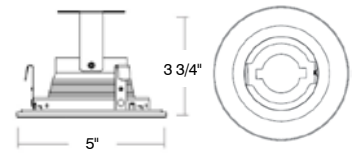

RT400WH
 White Reflector with White Ring
 Uses 50W R20, PAR20 Lamps
 Order Code: 79555

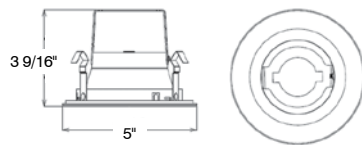

RT401BL/BAFF
 Black Metal Baffle (Only)
 Uses 50W R20, PAR20 Lamps
 Order Code: 78738

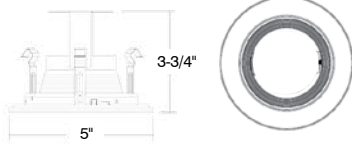

RT401BL
 Black Baffle with Black Ring
 Uses 50W R20, PAR20 Lamps
 Order Code: 79170

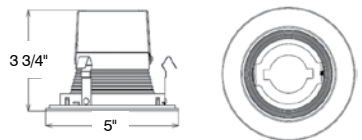

RT401BL/WH
 Black Baffle with White Ring
 Uses 50W R20, PAR20 Lamps
 Order Code: 70052

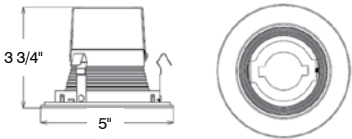

RT401BL/CH
 Black Reflector with Chrome Ring
 Uses 50W R20, PAR20 Lamps
 Order Code: 78733

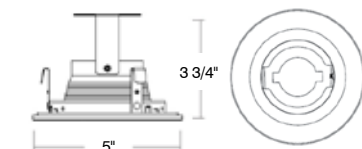

RT401WH
 White Baffle with White Ring
 Uses 50W R20, PAR20 Lamps
 Order Code: 79129

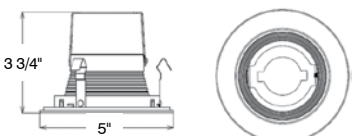

4" Line Voltage Trims



RT403BL
Black Eyeball
Uses 50W R20, PAR20 Lamps
Order Code: 78094

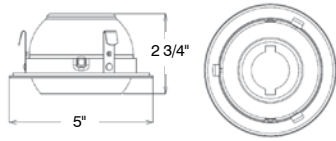

RT409WH/A
Albalite Lens White Shower Trim
Uses 50W R20, PAR20 Lamps
Order Code: 77605

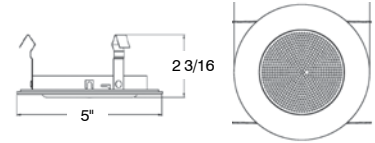

RT403WH
White Eyeball
Uses 50W R20, PAR20 Lamps
Order Code: 77606

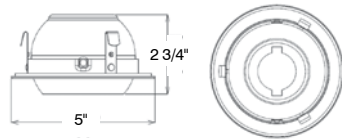

RT409WH/FL
Fresnel Glass White Shower Trim
Uses 50W R20, PAR20 Lamps
Order Code: 77672

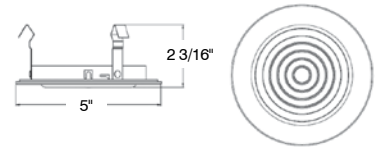

RT406BL
Open Black Gimbal with Black Ring
Uses 50W R20, PAR20 Lamps
Order Code: 79190

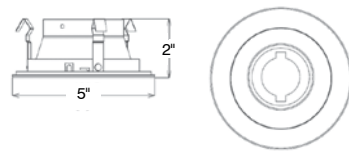

RT421WH
White Baffle with White Wall Wash
Uses 50W R20, PAR20 Lamps
Order Code: 77607

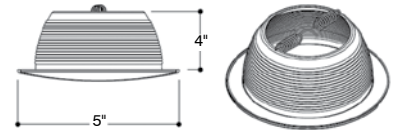

RT406WH
Open White Gimbal with White Ring
Uses 50W R20, PAR20 Lamps
Order Code: 78342

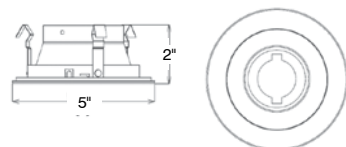

RT429WH
4" White Square Cover with
White Round Gimbal
Uses 50W R20, PAR20 Lamps
Order Code: 77608

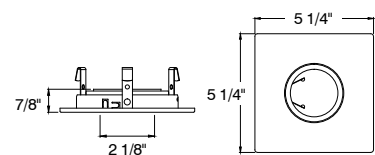

5" Line Voltage New Construction Housing

Features

- 75 watt PAR/BR30
- Plaster frame: Galvanized steel construction. The housing can be removed from plaster frame to provide access to the junction box.
- Thermal protector: Self resetting thermal protector deactivates fixture if overheating occurs due to improper lamping or misapplied insulation
- UL Listed for damp location
- UL Listed for feed through wiring
- Certified under ASTM-E283 for airtight construction

Installation

- Bar hanger: Pre-installed nails easily install in regular or engineered lumber. Bar hangers are adjustable from 13-5/8" to 25" and can be repositioned 90 degree on plaster frame
- Junction box: Listed for through branch circuit wiring. Contains seven 7/8" knockouts and four Romex pryouts with strain relief



IC Airtight

Item #: RH5/N/IC/AT

Order Code: 77604

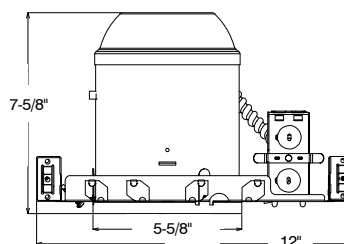
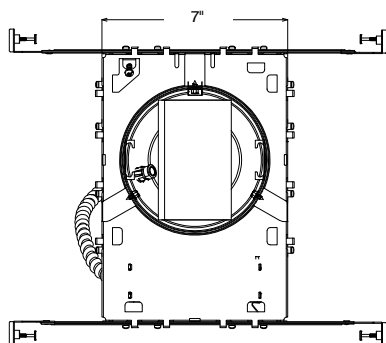

5" Line Voltage Remodel Construction Housing

Features

- 75 watt PAR/BR30
- Thermal protector: Self resetting thermal protector deactivates fixture if overheating occurs due to improper lamping or misapplied insulation
- Remodel clips: Four remodel clips secure housing and accommodates 1/2" and 5/8" ceiling materials
- UL Listed for damp location
- UL Listed for feed through wiring
- Certified under ASTM-E283 for airtight construction

Installation

- Junction box: Listed for through branch circuit wiring. Contains seven 7/8" knockouts and four Romex pryouts with strain relief



IC Airtight

Item #: RH5/R/IC/AT

Order Code: 77603

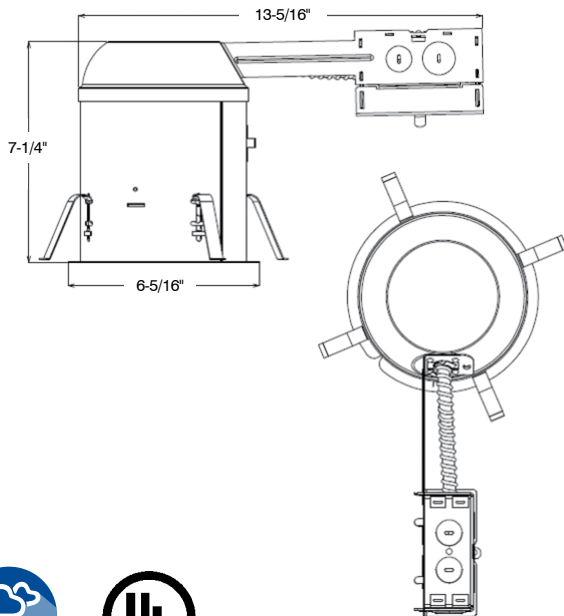

5" Line Voltage Trims



RT500CL/WH

Deep Clear Reflector with White Ring
Uses 75W Max BR30, PAR30 Lamps
Order Code: 79163

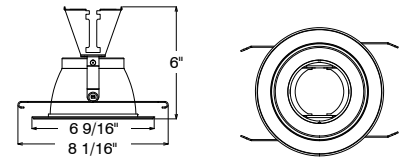

RT501WH

White Shallow Baffle Trim
Uses 75W Max BR30, PAR30 Lamps
Order Code: 77601

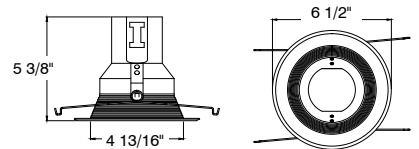

RT502WH

White Step Baffle with White Ring
Uses 75W Max BR30, PAR30 Lamps
Order Code: 79164

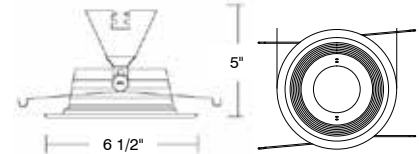

RT509WH/A

Albalite Glass Lens with White Ring
Uses 40W A19, 50W PAR20 Lamps
Order Code: 79410

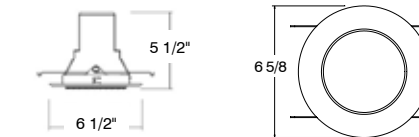

RT509WH/FL

Fresnel Shower Trim with White Ring
Uses 40W A19, 50W PAR20 Lamps
Order Code: 77602

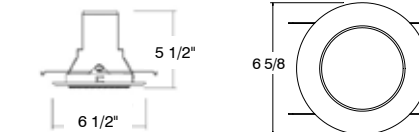

6" Line Voltage New Construction Housing

Features

- 75 watt max
- Plaster frame: Galvanized steel construction. Housing can be removed from plaster frame to provide access to the junction box.
- Thermal protector: Self resetting thermal protector deactivates fixture if overheating occurs due to improper lamping or misapplied insulation
- UL Listed for damp location
- UL Listed for feed through wiring
- Certified under ASTM-E283 for airtight construction

Installation

- Bar hanger: Pre-installed nails easily install in regular or engineered lumber. Bar hangers are adjustable from 13-5/8" to 25" and can be repositioned 90 degree on plaster frame
- Junction box: Listed for through branch circuit wiring. Contains seven 7/8" knockouts and four Romex pryouts with strain relief



IC Airtight

Item #: RH6/N/IC/ATS

Order Code: 78516



IC/AT Airtight with Floating Socket

Item #: RH6/N/IC/ATS/FL

Order Code: 77841

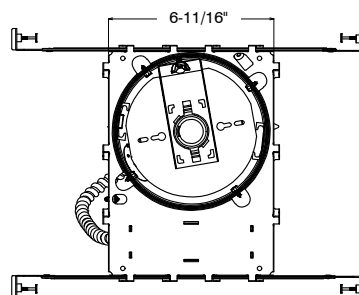
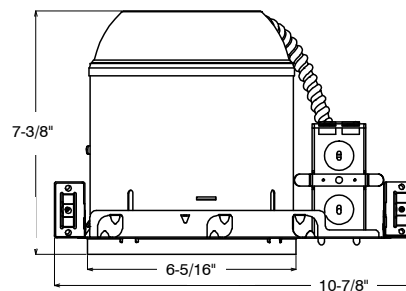
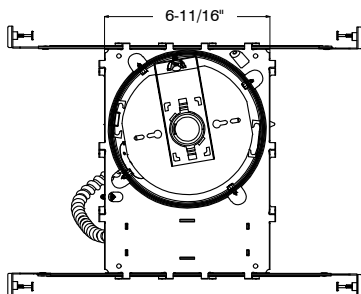
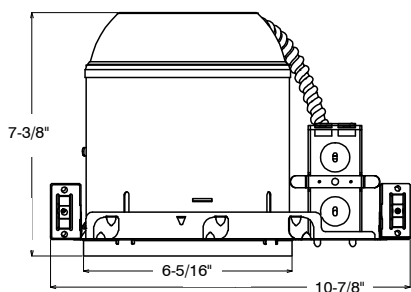

6" Line Voltage New Construction Housing

Features

- 75 watt max
- Plaster frame: Galvanized steel construction. Housing can be removed from plaster frame to provide access to the junction box
- Thermal protector: Self resetting thermal protector deactivates fixture if overheating occurs due to improper lamping or misapplied insulation
- UL Listed for damp location
- UL Listed for feed through wiring

Installation

- Bar hanger: Pre-installed nails easily install in regular or engineered lumber. Bar hangers are adjustable from 13-5/8" to 25" and can be repositioned 90 degree on plaster frame
- Junction box: Listed for through branch circuit wiring. Contains seven 7/8" knockouts and four Romex pryouts with strain relief
- Housing: Galvanized steel construction



IC Steel

Item #: RH6/N/ICS

Order Code: 78521

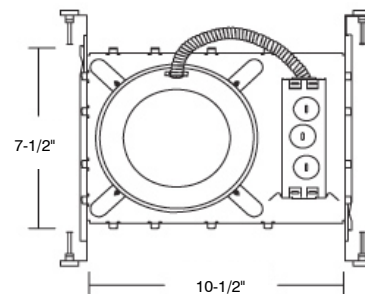
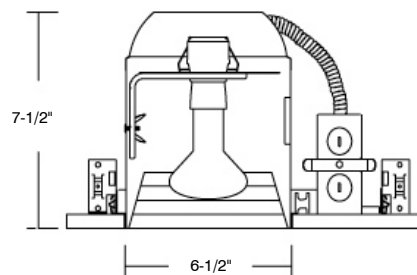

6" Line Voltage New Construction Housing

Features

- 75 watt max
- Plaster frame: Galvanized steel construction. Housing can be removed from plaster frame to provide access to the junction box.
- Thermal protector: Self resetting thermal protector deactivates fixture if overheating occurs due to improper lamping or misapplied insulation
- UL Listed for damp location
- UL Listed for feed through wiring
- Certified under ASTM-E283 for airtight construction (RH6/N/IC/AT only)

Installation

- Bar hanger: Pre-installed nails easily install in regular or engineered lumber. Bar hangers are adjustable from 13-5/8" to 25" and can be repositioned 90 degree on plaster frame
- Junction box: Listed for through branch circuit wiring. Contains seven 7/8" knockouts and four Romex pryouts with strain relief

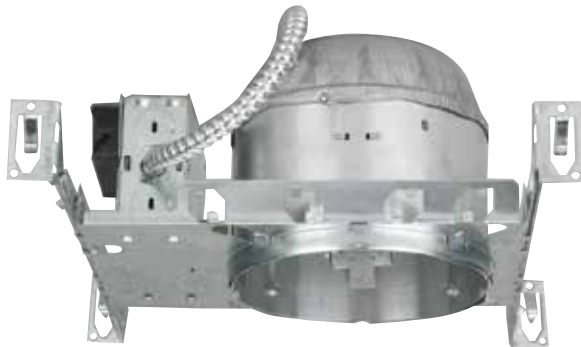

Shallow IC

Item #: RH6/N/S/IC

Order Code: 77664



Shallow IC Airtight

Item #: RH6/N/S/IC/AT

Order Code: 78532

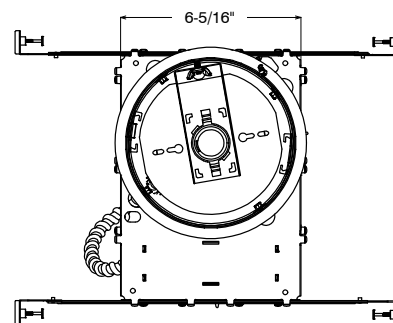
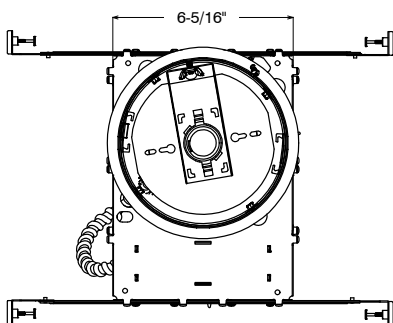
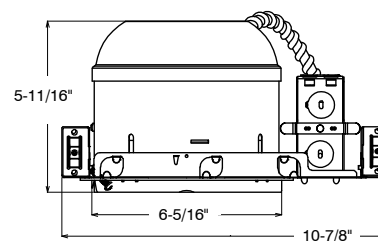
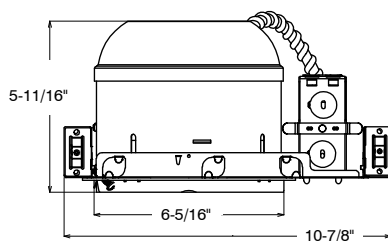

6" Line Voltage Remodel Construction Housing

Features

- 75 watt max
- Remodel clips: Four remodel clips secure housing and accommodates 1/2" and 5/8" ceiling materials
- Thermal protector: Self resetting thermal protector deactivates fixture if overheating occurs due to improper lamping or misapplied insulation
- UL Listed for damp location
- UL Listed for feed through wiring
- Certified under ASTM-E283 for airtight construction (RH6/R/IC/AT only)

Installation

- Junction box: Listed for through branch circuit wiring. Contains six 7/8", one 1-1/8" knockouts and four Romex pryouts with strain relief



IC

Item #: RH6/R/IC

Order Code: 77661



IC Airtight

Item #: RH6/R/IC/AT

Order Code: 79415

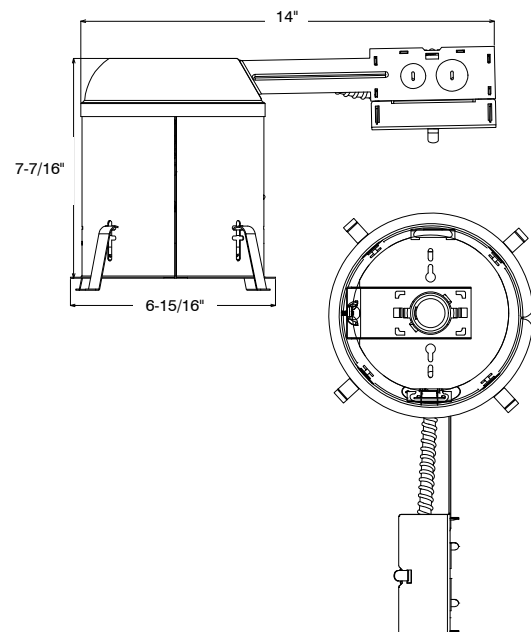
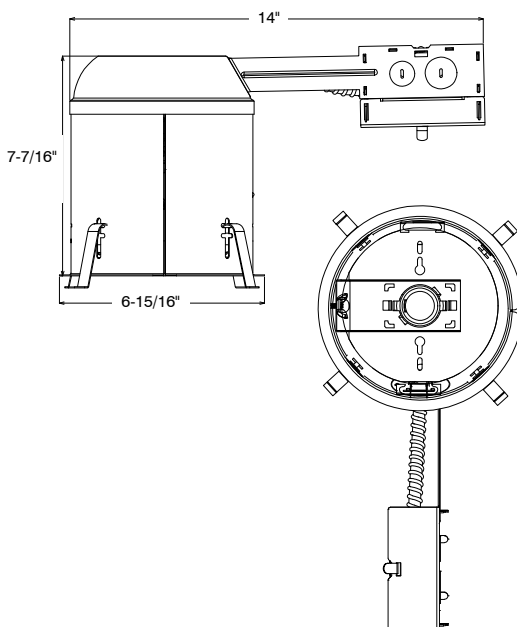

6" Line Voltage Remodel Construction Housing

Features

- 75 watt max
- Remodel clips: Four remodel clips secure housing and accommodates 1/2" and 5/8" ceiling materials
- Thermal protector: Self resetting thermal protector deactivates fixture if overheating occurs due to improper lamping or misapplied insulation
- UL Listed for damp location
- UL Listed for feed through wiring

Installation

- Junction box: Listed for through branch circuit wiring. Contains six 7/8", one 1-1/8" knockouts and four Romex pryouts with strain relief



Shallow Non-IC

Item #: RH6/R/S

Order Code: 77665

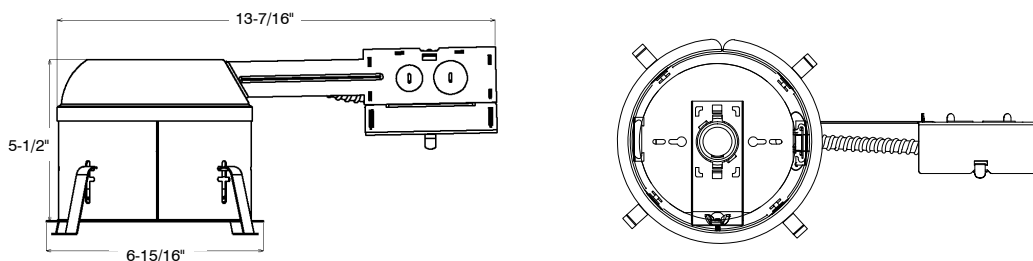

6" Line Voltage Remodel Construction Housing

Features

- 75 watt max
- Remodel clips: Four remodel clips secure housing and accommodates 1/2" and 5/8" ceiling materials
- Thermal protector: Self resetting thermal protector deactivates fixture if overheating occurs due to improper lamping or misapplied insulation
- UL Listed for damp location
- UL Listed for feed through wiring
- Certified under ASTM-E283 for airtight construction (RH6/R/S/IC/AT only)

Installation

- Junction box: Listed for through branch circuit wiring. Contains six 7/8", one 1-1/8" knockouts and four Romex pryouts with strain relief



Shallow IC

Item #: RH6/R/S/IC

Order Code: 77662



Shallow IC Airtight

Item #: RH6/R/S/IC/AT

Order Code: 78534

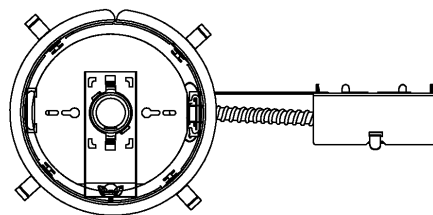
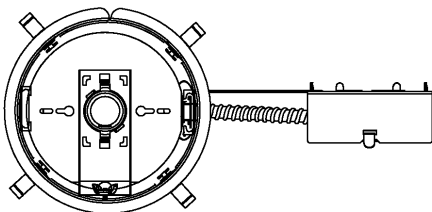
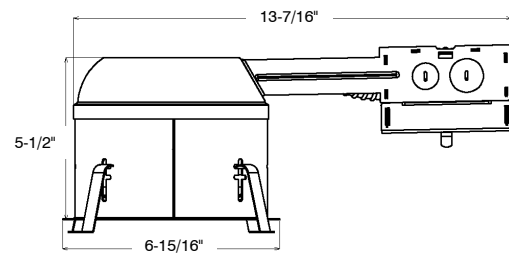
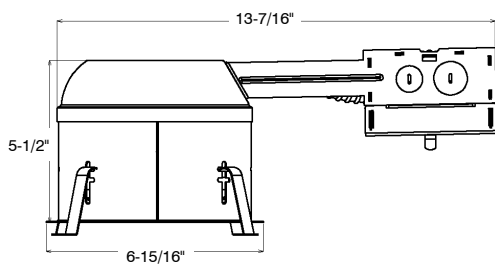

6" Line Voltage Trims



RT600CL/CH/R30
Clear Reflector with Chrome Ring
Uses BR/PAR30 Lamps
Order Code: 71902

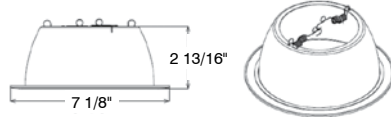

RT601BL
Black Step Baffle with Black Ring
Uses BR/PAR30 Lamps
Order Code: 79604

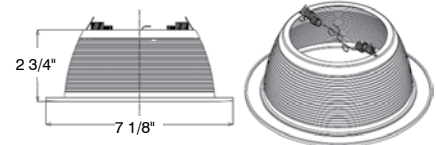

RT600CL/WH/R30
Clear Reflector with White Ring
Uses BR/PAR30 Lamps
Order Code: 77703

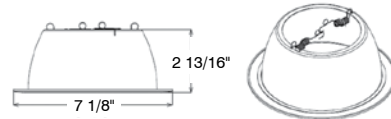

RT601BL/WH
Black Step Baffle with White Ring
Uses BR/PAR30 Lamps
Order Code: 77102

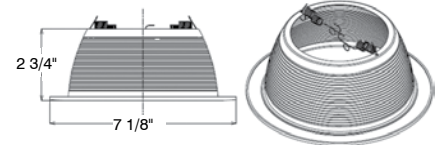

RT600CL/WH/R40
Clear Reflector with White Ring
Uses R40/PAR38 Lamps
Order Code: 78366

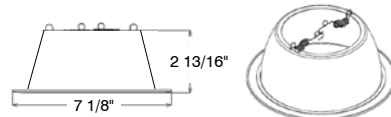

RT601SCH
All Satin Chrome Step Baffle
Uses BR/PAR30 Lamps
Order Code: 70960

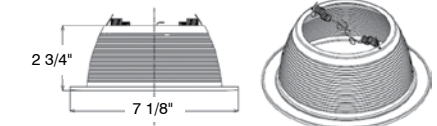

RT600GO/WH/R30
Gold Reflector with White Ring
Uses BR/PAR30 Lamps
Order Code: 79552

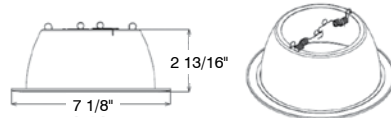

RT601WH
White Step Baffle with White Ring
Uses BR/PAR30 Lamps
Order Code: 79135

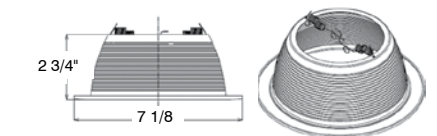

RT600WH/R30
White Reflector with White Ring
Uses BR/PAR30 Lamps
Order Code: 79162

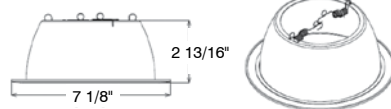

RT602BL
Black Step Baffle with Black Ring
Uses R40/PAR38 Lamps
Order Code: 78102

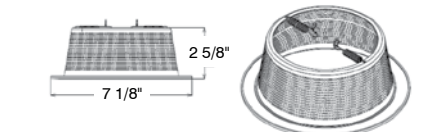

6" Line Voltage Trims



RT602BL/WH

Black Step Baffle with White Ring
Uses R40/PAR38 Lamps
Order Code: 79179

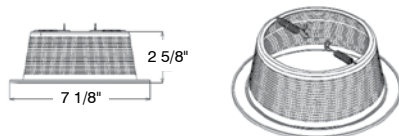

RT602WH

White Step Baffle with White Ring
Uses R40, PAR38 Lamps
Order Code: 77673

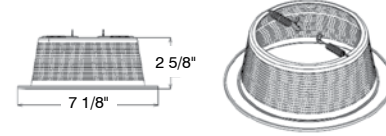

RT602BL/WH/AT

Socket Supporting Black Step Baffle with White Ring, Airtight, Torsion Springs, for Floating Medium Base Socket
Uses BR/PAR30 Lamps
Order Code: 79610

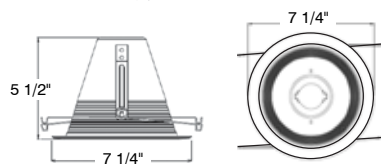

RT602WH/AT

Socket Supporting Matte White Step Baffle with White Ring, Airtight, Torsion Springs, for Floating Medium Base Socket
Uses BR/PAR30 Lamps
Order Code: 77598

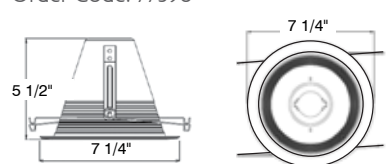

RT602GW/AT

Socket Supporting Gloss White Step Baffle with White Ring, Airtight, Torsion Springs, for Floating Medium Base Socket
Uses BR/PAR30 Lamps
Order Code: 77565

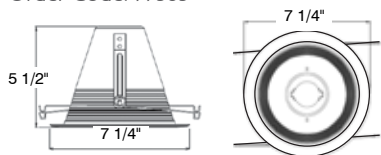

RT603BL

Black Eyeball
Uses BR/PAR30 Lamps
Order Code: 79573

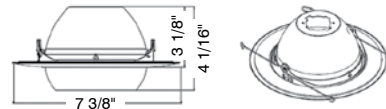

RT602GW/AT/FS

Socket Supporting Gloss White Step Baffle with White Ring, Airtight, Friction Springs, for Floating Medium Base Socket
Uses BR/PAR30 Lamps
Order Code: 77564

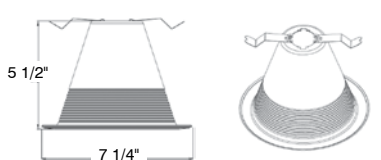

RT603WH

White Eyeball
Uses BR/PAR30 Lamps
Order Code: 79551

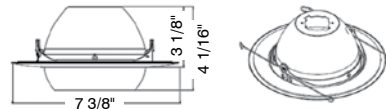

RT602SCH

Satin Chrome Step Baffle with Satin Chrome Ring
Uses R40, PAR38 Lamps
Order Code: 78103

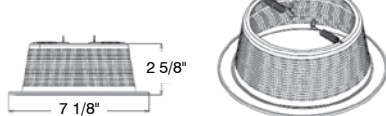

RT604SCH

Open Satin Chrome Trim
Uses BR/PAR30 Lamps
Order Code: 78107



6" Line Voltage Trims



RT604WH
Open White Trim
Uses BR/PAR30 Lamps
Order Code: 78762



RT609WH/FL/P
Fresnel Glass Lens with White Plastic Ring Shower Trim
Uses 40W A19 Lamps
Order Code: 79160



RT605WH
Open White Ring
Uses R40/PAR38 Lamps
Order Code: 70959



RT609WH/FR/P
Frosted Glass Lens with White Plastic Ring Shower Trim
Uses 40W A19 Lamps
Order Code: 79160

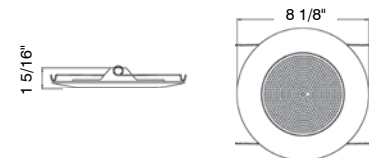

RT609WH/A
Albalite Lens Shower Trim with Metal Ring
Uses 40W A19 Lamps
Order Code: 79136

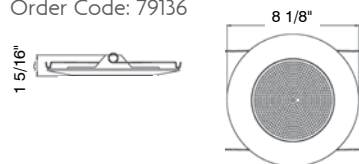

RT610CL/WH
Clear Deep Reflector with White Ring
Uses 60W A19 Lamps
Order Code: 79156

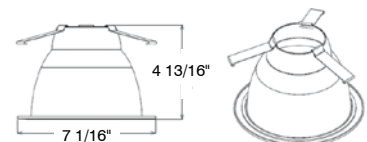

RT609WH/A/P
Albalite Lens Shower Trim with Plastic Ring
Uses 40W A19 Lamps
Order Code: 79137

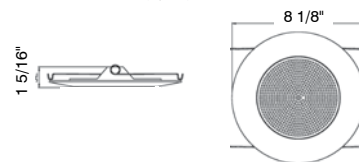

RT611WH
Clear Deep Reflector with White Step Baffle and White Ring
Uses 60W A19
Order Code: 79158

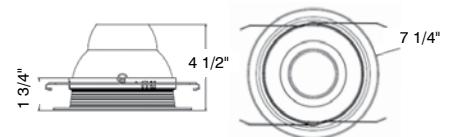

RT609WH/FL
Fresnel Glass Lens with White Metal Ring Shower Trim
Uses 40W A19 Lamps
Order Code: 77559



RT612WH
White Step Baffle with White Ring
Uses BR/PAR30 Lamps
Order Code: 79159

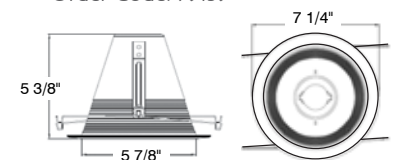



RT613WH/R

White Baffle with White Regressed Eyeball
 Uses BR/PAR30 Lamps
 Order Code: 77599

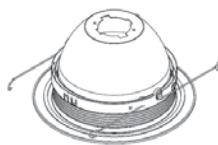
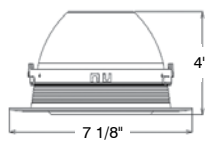

RT614GW

Gloss White Deep Smooth Cone
 Uses BR/PAR30 Lamps
 Order Code: 79850

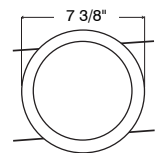
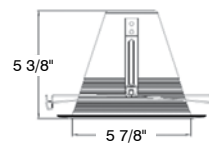

6" Line Voltage New Construction Housing for Sloped Ceilings

Features

- 75 watt max
- Housing: Designed for use in ceiling with slopes from 2/12 to 6/12
- Socket: The socket aiming mechanism allows the lamp to be aimed straight down regardless of ceiling pitch
- Thermal protector: Self resetting thermal protector deactivates fixture if overheating occurs due to improper lamping or misapplied insulation
- UL Listed for damp location
- UL Listed for feed through wiring
- Certified under ASTM-E283 for airtight construction

Installation

- Bar hanger: Pre-installed nails easily install in regular or engineered lumber. Bar hangers are adjustable from 13-5/8" to 25" and can be repositioned 90 degree on plaster frame
- Junction box: Listed for through branch circuit wiring. Contains seven 7/8" knockouts and four Romex pryouts with strain relief



IC Airtight

Item #: RH6/NSL/IC/AT

Order Code: 78515

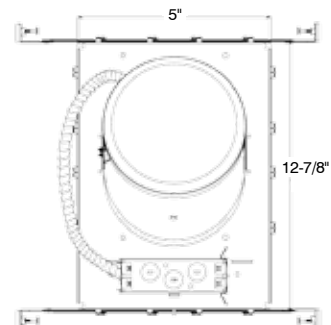
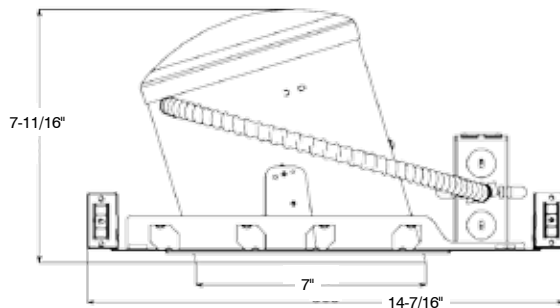

6" Line Voltage New Construction Housing for Sloped Ceilings

Features

- 150 watt max
- Housing: Designed for use in ceiling with slopes from 2/12 to 6/12
- Socket: The socket aiming mechanism allows the lamp to be aimed straight down regardless of ceiling pitch
- Thermal protector: Self resetting thermal protector deactivates fixture if overheating occurs due to improper lamping or misapplied insulation
- UL Listed for damp location
- UL Listed for feed through wiring

Installation

- Bar hanger: Pre-installed nails easily install in regular or engineered lumber. Bar hangers are adjustable from 13-5/8" to 25" and can be repositioned 90 degree on plaster frame
- Junction box: Listed for through branch circuit wiring. Contains seven 7/8" knockouts and four Romex pryouts with strain relief



IC

Item #: RH6/NSL/IC/BOX

Order Code: 78119

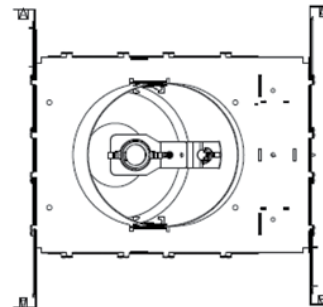
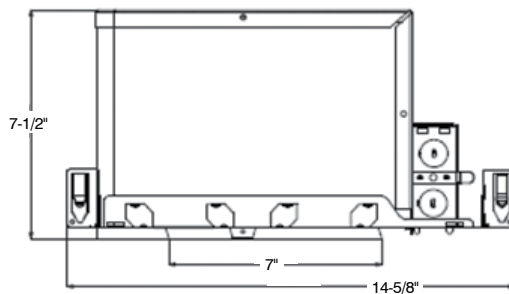

6" Line Voltage Remodel Housing for Sloped Ceilings

Features

- 75 watt max
- Housing: Designed for use in ceiling with slopes from 2/12 to 6/12
- Socket: The socket aiming mechanism allows the lamp to be aimed straight down regardless of ceiling pitch
- Thermal protector: Self resetting thermal protector deactivates fixture if overheating occurs due to improper lamping or misapplied insulation
- UL Listed for damp location
- UL Listed for feed through wiring
- Certified under ASTM-E283 for airtight construction

Installation

- Junction box: Listed for through branch circuit wiring. Contains six 7/8", one 1-1/8" knockouts and four Romex pryouts with strain relief



IC Airtight

Item #: RH6/RSL/IC/AT

Order Code: 79536

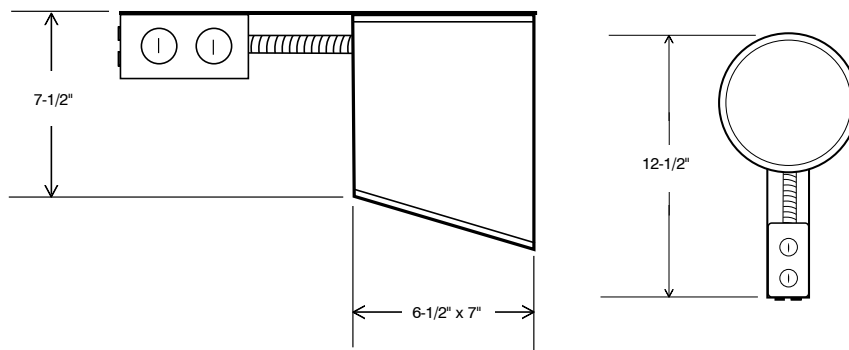

6" Line Voltage Trims for Sloped Ceilings



RT600CL/WH/SC

Clear Reflector with White Ring
Uses BR40, PAR38 Lamps
Order Code: 70026

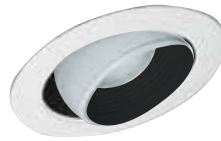
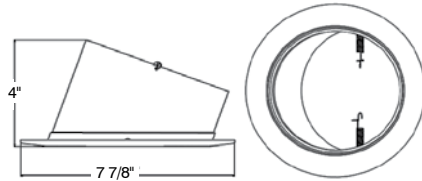

RT604BL/WH/SC

Black Baffle with White Eyeball
Uses BR/PAR30 Lamps
Order Code: RT604BL/WH/SC

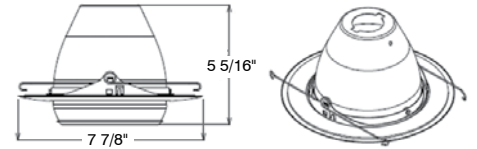

RT602BL/WH/SC

Black Baffle with White Ring
Uses BR40, PAR38 Lamps
Order Code: 70025

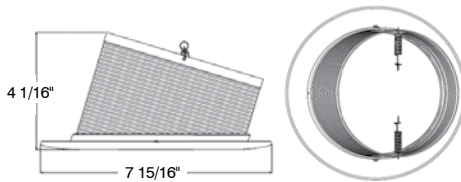

RT604WH/SC

White Baffle with White Eyeball
Uses BR/PAR30 Lamps
Order Code: 78129

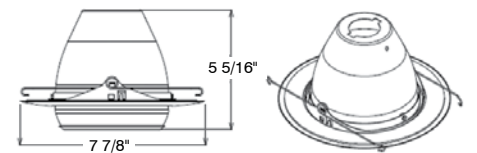

RT602WH/SC

White Baffle with White Ring
Uses BR40, PAR38 Lamps
Order Code: 78154

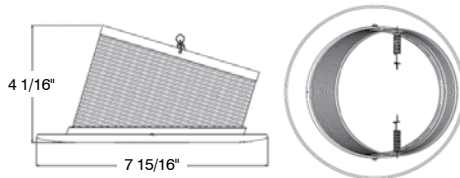

RT603WH/WH/SC

White Baffle with White Eyeball
Uses BR/PAR30 Lamps
Order Code: 78129

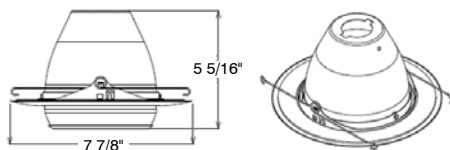

4" GU10 New Construction Housing

Features

- 50 watt max 120V GU10 MR16
- Thermal protector: Self resetting thermal protector deactivates fixture if overheating occurs due to improper lamping or misapplied insulation
- Plaster frame: Galvanized steel construction. The housing can be removed from plaster frame to provide access to the junction box
- UL Listed for damp location
- UL Listed for feed through wiring
- Certified under ASTM-E283 for airtight construction (RH4/NG/IC/AT only)

Installation

- Bar hanger: Pre-installed nails easily install in regular or engineered lumber. Bar hangers are adjustable from 13-5/8" to 25" and can be repositioned 90 degree on plaster frame
- Junction box: Listed for through branch circuit wiring. Contains seven 7/8" knockouts, and four Romex pryouts with strain relief



Non-IC

Item #: RH4/NG

Order Code: 79550



IC Airtight

Item #: RH4/NG/IC/AT

Order Code: 77704

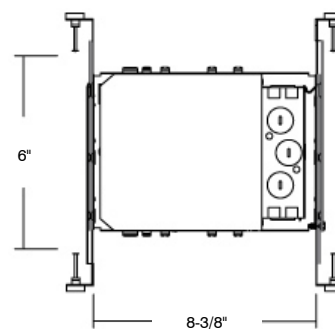
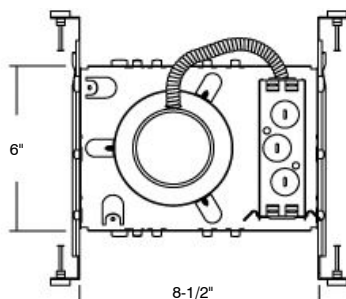
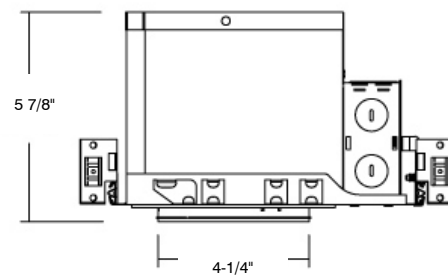
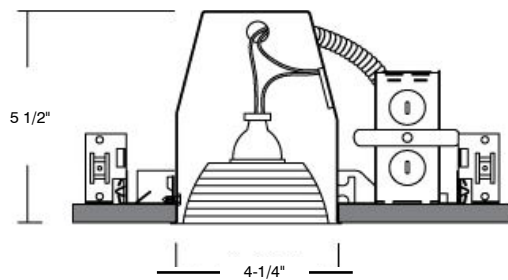

4" GU10 Remodel Construction Housing

Features

- 50 watt max 120V GU10 MR16
- Thermal protector: Self resetting thermal protector deactivates fixture if overheating occurs due to improper lamping or misapplied insulation.
- Remodel clips: Four remodel clips secure housing and accommodates 1/2" and 5/8" ceiling materials.
- UL Listed for damp location
- UL Listed for feed through wiring

Installation

- Junction box: Listed for through branch circuit wiring. Contains seven 7/8" knockouts and four Romex pryouts with strain relief.



Non-IC

Item #: RH4/RG

Order Code: 78282

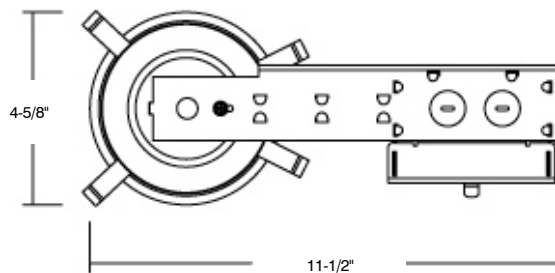
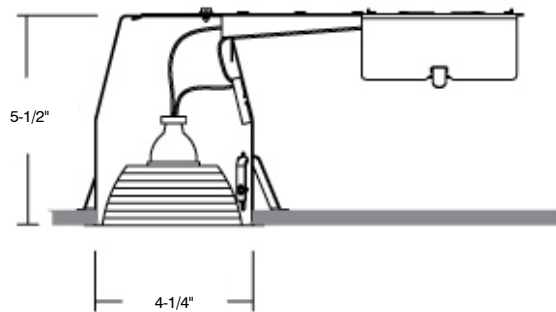

4" GU10 Line Voltage Recessed Trims



RT400CL/WH/LV
 Clear Reflector with White Ring
 Uses 50W 120V GU10 Lamps
 Order Code: 78356

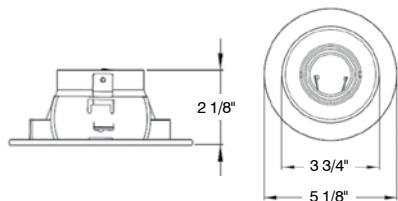

RT401WH/LV
 All Steel White Baffle with White Ring
 Uses 50W 120V GU10 Lamps
 Order Code: 79127

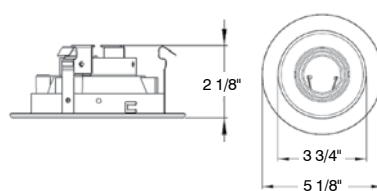

RT400WH/LV
 White Reflector with White Ring
 Uses 50W 120V GU10 Lamps
 Order Code: 79128

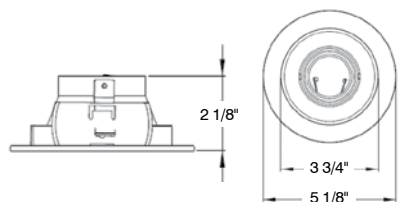

RT408BL/LV
 Black Slot Aperture
 Uses 50W 120V GU10 Lamps
 Order Code: 78166

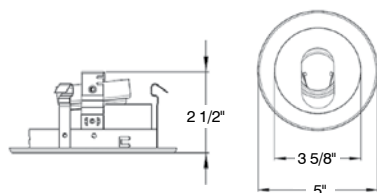

RT401BL/LV
 All Steel Black Baffle with Black Ring
 Uses 50W 120V GU10 Lamps
 Order Code: 78156

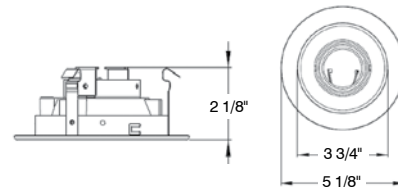

RT408WH/LV
 White Slot Aperture
 Uses 50W 120V GU10 Lamps
 Order Code: 78165

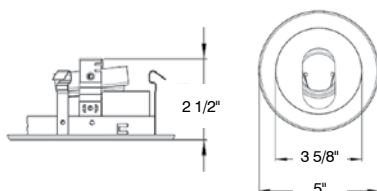

RT401BL/WH/LV
 All Steel Black Baffle with White Ring
 Uses 50W 120V GU10 Lamps
 Order Code: 71910

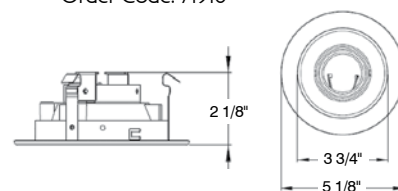

RT413WH/LV
 Deep Step Baffle with White Eyeball
 Uses 50W 120V GU10 Lamps
 Order Code: 78362

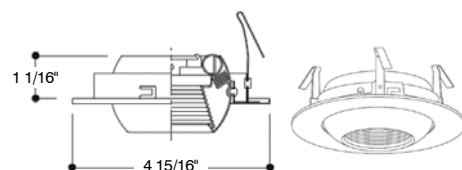

4" GU10 Line Voltage Recessed Trims



RT422CH/LV

Chrome Square Gimbal with
Chrome Square Body
Uses 50W 120V GU10 Lamps
Order Code: 78171

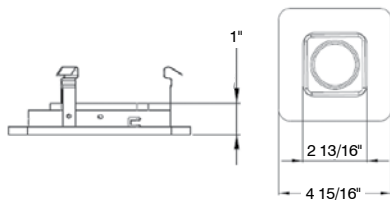

RT432CH/LV

Round Chrome Gimbal
Uses 50W 120V GU10 Lamps
Order Code: RT432CH/LV

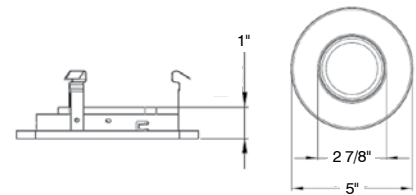

RT422WH/LV

White Square Gimbal with
White Square Body
Uses 50W 120V GU10 Lamps
Order Code: 77534

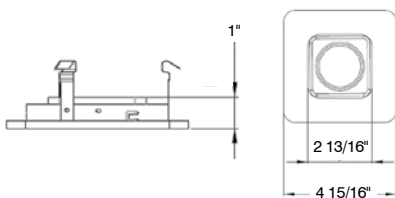

RT432WH/LV

Round White Gimbal
Uses 50W 120V GU10 Lamps
Order Code: 79169

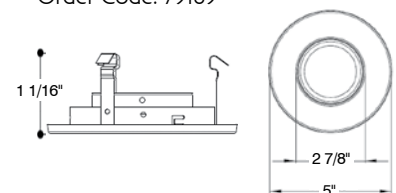

GU24 New Construction Housing

Features

- Socket for one 11-18W GU24 120V (RH4/NG/118/IC/AT)
- Socket for one 11-27W GU24 120V (RH6/NG/126/IC/AT)
- Housing: Single wall aluminum
- UL Listed for damp location
- UL Listed for feed through wiring
- Certified under ASTM-E283 for airtight construction
- ENERGY STAR qualified
- Meets TITLE 24 requirements

Installation

- Bar hanger: Pre-installed nails easily install in regular or engineered lumber. Bar hangers are adjustable from 13-5/8" to 25" and can be repositioned 90 degree on plaster frame
- Junction box: Listed for through branch circuit wiring. Contains seven 7/8" knockouts and four Romex pryouts with strain relief



4" IC Airtight

Item #: RH4/NG/118/IC/AT

Order Code: 79424

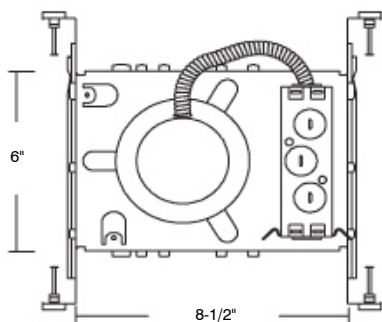
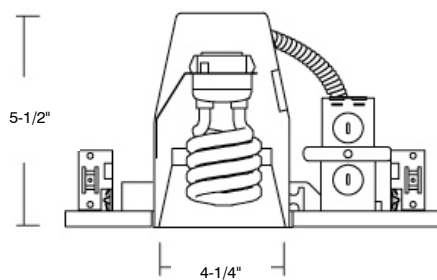

6" IC Airtight

Item #: RH6/NG/126/IC/AT

Order Code: 79425

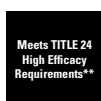
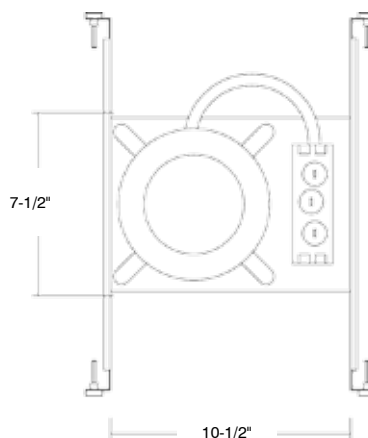
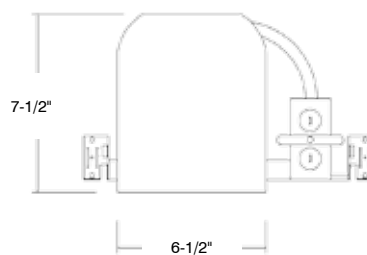

GU24 Remodel Housing

Features

- Socket for one 11-27W GU24 120V
- Housing: Single wall aluminum housing
- Remodel clips: Four remodel clips secure housing and accommodates 1/2" and 5/8" ceiling materials.
- UL Listed for damp location
- UL Listed for Feed Through wiring
- Certified under ASTM-E283 for Airtight construction
- ENERGY STAR qualified
- Meets TITLE 24 requirements

Installation

- Junction box: Listed for through branch circuit wiring. Contains seven 7/8", one 1-1/8" knockouts and four Romex pryouts with strain relief.



4" IC Airtight

Item #: RH4/RG/118/IC/AT

Order Code: 79416

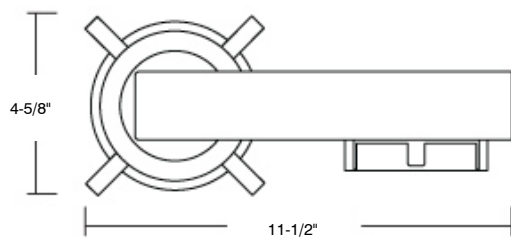
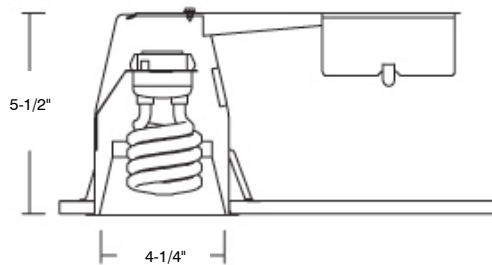

6" IC Airtight Vertical Mount

Item #: RH6/RG/126/IC/AT

Order Code: 79417

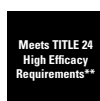
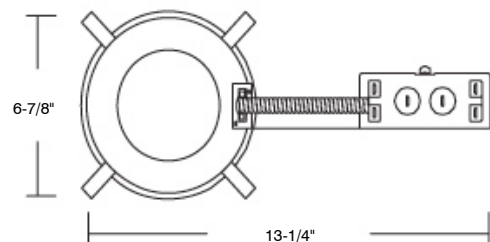
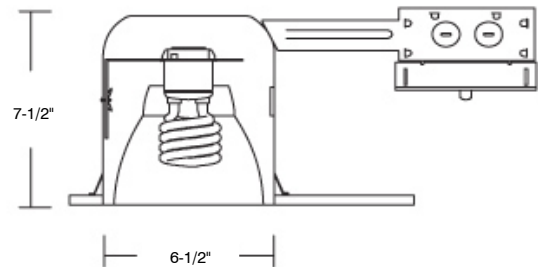

4" GU24 Recessed Trims



RT410CL/WH/G

White GU24 Trim with
Clear Deep Reflector
Uses 11-18W GU24 Lamps
Order Code: 79448

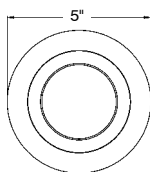
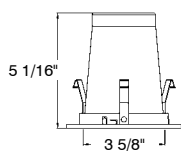

RT412WH/G

White Deep GU24 Stepped Baffle with
White Ring
Uses 11-18W GU24 Lamps
Order Code: 79447

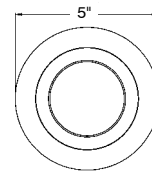
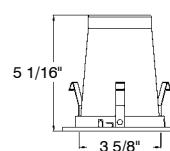

6" GU24 Recessed Trims



RT600WH/R30
 White Reflector with White Ring
 Uses 11-27W GU24 Lamps
 Order Code: 79162

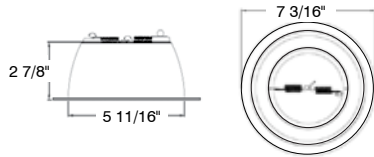

RT601WH
 White Step Baffle with White Ring
 Uses 11-27W GU24 Lamps
 Order Code: 79135

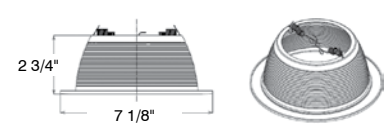

RT601BL
 Black Step Baffle with Black Ring
 Uses 11-27W GU24 Lamps
 Order Code: 79604

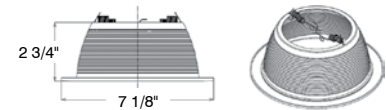

RT601BL/WH
 Black Step Baffle with White Ring
 Uses 11-27W GU24 Lamps
 Order Code: 77102

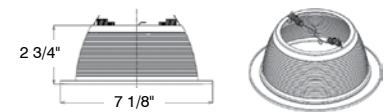

RT601SCH
 All Satin Chrome Step Baffle
 Uses 11-27W GU24 Lamps
 Order Code: 70960

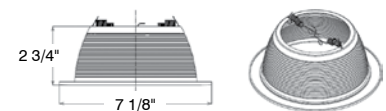

6" GU24 Recessed Trims



RT609WH/A
 Albalite Lens Shower Trim with
 White Metal Ring
 Uses 11-27W GU24 Lamps
 Order Code: 79136

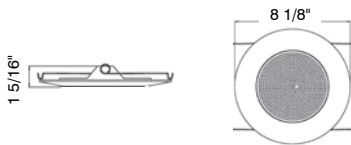

RT609WH/FL/P
 Fresnel Glass Lens with White Plastic Ring
 Uses 18-26W Quad/Triple Tube Lamps
 Order Code: 79160

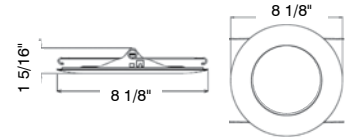

RT609WH/A/P
 Albalite Lens Shower Trim with
 White Plastic Ring
 Uses 11-27W GU24 Lamps
 Order Code: 79137

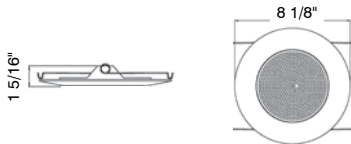

RT609WH/FR/P
 Frosted Glass Lens with White Plastic Ring
 Uses 11-27W GU24 Lamps
 Order Code: 79155

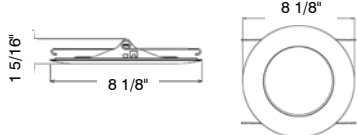

RT609WH/DO/P
 Drop Opal Lens with White Plastic Ring
 Uses 11-27W GU24 Lamps
 Order Code: 75971

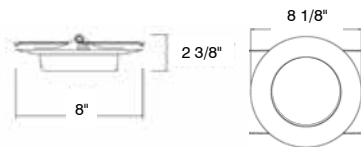

RT610CL/WH
 Clear Deep Reflector with White Ring
 Uses 11-27W GU24 Lamps
 Order Code: 79156

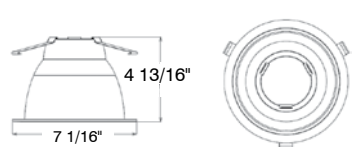

RT609WH/FL
 Fresnel Glass Lens with White Metal Ring
 Uses 11-27W GU24 Lamps
 Order Code: 77559

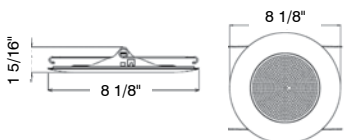

RT611BL/WH
 Clear Deep Reflector with Black Step
 Baffle and White Ring
 Uses 11-27W GU24 Lamps
 Order Code: 79157

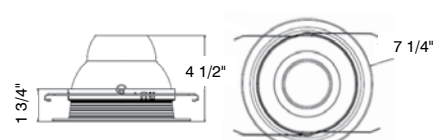

6" GU24 Recessed Trims



RT611WH

Clear Deep Reflector with White Step Baffle and White Ring
Uses 11-27W GU24 Lamps
Order Code: 79158

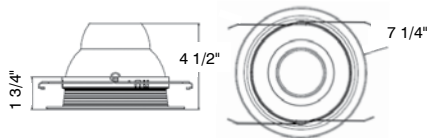

RT612WH

White Step Baffle with White Ring
Uses 11-27W GU24 Lamps
Order Code: 79159

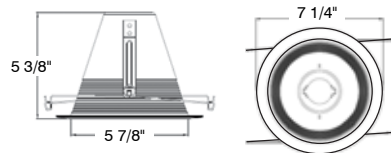

RT619WH/A/P

Albalite Shower Trim with Clear Deep Reflector and White Plastic Ring
Uses 11-27W GU24 Lamps
Order Code: 77572

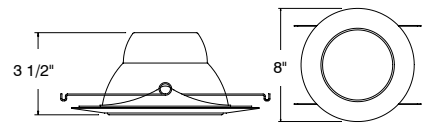

RT614C

Clear Deep Smooth Cone w/White Ring
Uses 11-27W GU24 Lamps
Order Code: 79851

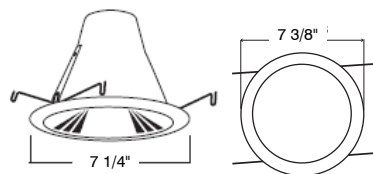

RT620WH

White Wall Wash
Uses 11-27W GU24 Lamps
Order Code: 78077

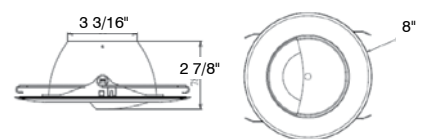

RT614GW

Gloss White Deep Smooth Cone
Uses 11-27W GU24 Lamps
Order Code: 79850

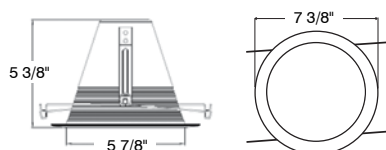

RT621WH

White Baffle with White Wall Wash
Uses 11-27W GU24 Lamps
Order Code: 77600

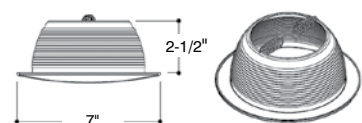



Low Voltage Recessed Downlighting

Topaz's residential/commercial low voltage housings and trims are the perfect choice for new and remodel construction. Available in 3 and 4 inch diameter openings to accommodate a wide array of 12V, MR16 trims to complement any style. Offered in both IC and Non-IC rated fixtures to meet local building code requirements. Topaz low voltage trims are available in 50W or 75W configurations.

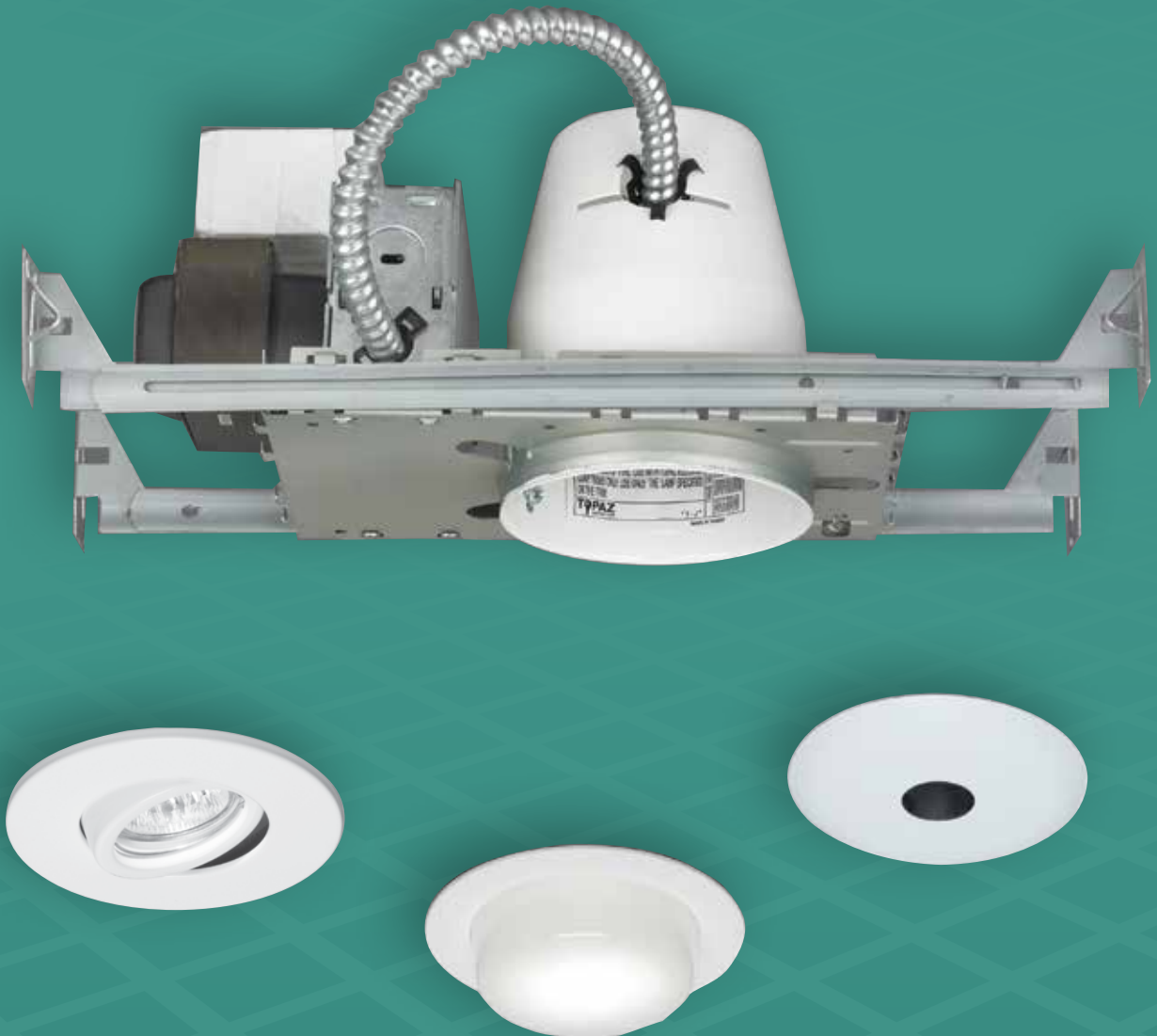

3" Low Voltage Remodel and New Construction Housings

Features

- 50 watt max. 12V MR16
- Plaster frame: Galvanized steel construction. The housing can be removed from plaster frame to provide access to the junction box
- Housing (RH3/NLV/IC/AT only): Double wall aluminum construction for greater heat dissipation. Housing adjusts for ceiling up to 1-1/4" thick
- Transformer: 120V Integral magnetic transformer steps line voltage down to lamp operating voltage. For lamps up to 50W.
- Thermal protector: Self resetting thermal protector deactivates fixture if overheating occurs due to improper lamping or misapplied insulation
- UL Listed for damp location
- UL Listed for feed through wiring
- Certified under ASTM-E283 for airtight construction (RH3/NLV/IC/AT only)

Installation

- Bar hanger: Pre-installed nails easily install in regular, or engineered lumber. Bar hangers are adjustable from 13-5/8" to 25" and can be repositioned 90 degrees on plaster frame
- Junction box: Listed for through branch circuit wiring. Contains six 7/8", one 1-1/8" knockouts and four Romex pryouts with strain relief



Non-IC

Item #: RH3/NLV

Order Code: 78339

(Remodel version available: Item # RH3/RLV/AT. Order Code: 78370)



IC Airtight

Item #: RH3/NLV/IC/AT

Order Code: 77531

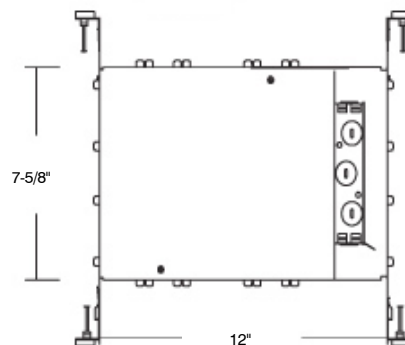
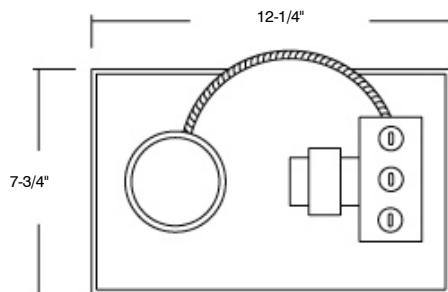
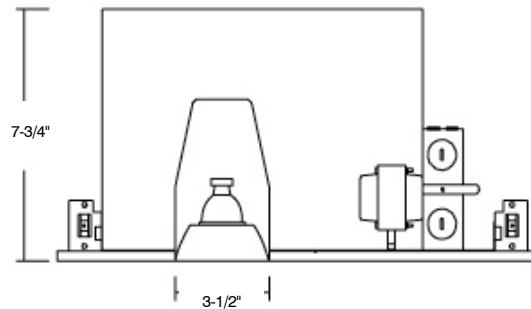
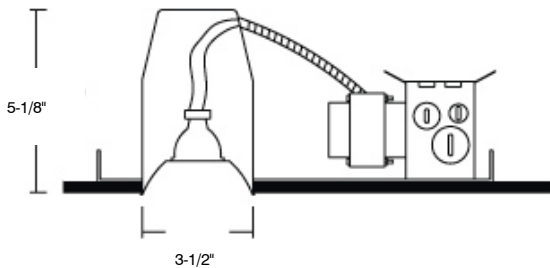

3" Low Voltage Remodel and New Construction Housings

Features

- 50 watt max. 12V MR16
- Plaster frame: (RH3/NLV/S) Galvanized steel construction. Housing can be removed from plaster frame to provide access to the junction box
- Thermal protector: Self resetting thermal protector deactivates fixture if overheating occurs due to improper lamping or misapplied insulation
- Remodel clips and support spring (RH3/RLV/S): Three remodel clips secure housing and accommodates 1/2" and 5/8" ceiling materials and support spring helps support weight of junction box and transformer. Automatically adjusts for different ceiling materials
- Transformer: 120V Integral magnetic transformer steps line voltage down to lamp operating voltage
- UL Listed for damp location
- UL Listed for feed through wiring
- Certified under ASTM-E283 for airtight construction

Installation

- Junction box: Listed for through branch circuit wiring. (RH3/NLV/S) contains three 7/8" knockouts, three 1-1/8" and four Romex pryouts with strain relief. (RH3/RLV/S) contains four 7/8" knockouts with strain relief
- Bar hanger: (RH3/NLV/S) Pre-installed nails easily install in regular, or engineered lumber. Bar hangers are adjustable from 13-5/8" to 25" and can be repositioned 90 degrees on plaster frame



Shallow Non-IC

Item #: RH3/NLV/S

Order Code: 79974

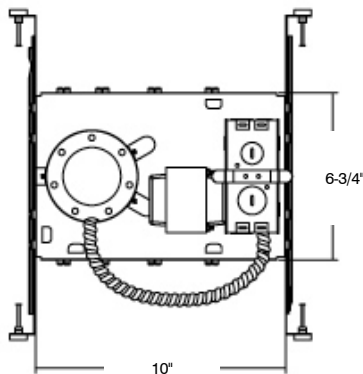
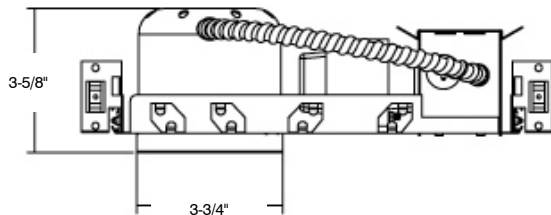

Shallow Non-IC

Item #: RH3/RLV/S

Order Code: 79975

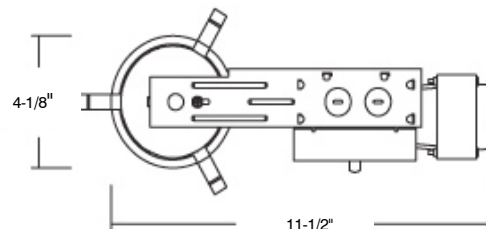
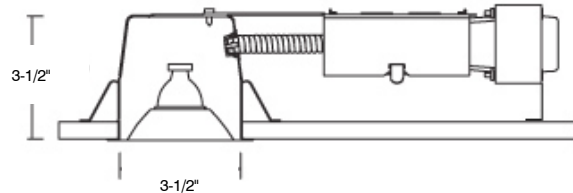

4" Low Voltage New Construction Housing

Features

- 50 watt max. 12V MR16 (RH4/NLV and RH4/NLV/S)
75 watt max. 12V MR16 (RH4/NLV/HW)
- Plaster frame: Galvanized steel construction. Housing can be removed from plaster frame to provide access to the junction box
- Transformer: 120V Integral magnetic transformer steps line voltage down to lamp operating voltage. For lamps up to 50W (RH4/NLV and RH4/NLV/S), and up to 75W (RH4/NLV/HW)
- Thermal Protector: Self resetting thermal protector deactivates fixture if overheating occurs due to improper lamping or misapplied insulation
- UL Listed for damp location
- UL Listed for feed through wiring

Installation

- Bar hanger: Pre-installed nails easily install in regular, or engineered lumber. Bar hangers are adjustable from 13-5/8" to 25" and can be repositioned 90 degrees on plaster frame
- Junction box: Listed for through branch circuit wiring. (RH4/NLV and RH4/NLV/HW) contain seven 7/8" knockouts and four Romex pryouts with strain relief. (RH4/NLV/S) contains one 1-1/8", one 5/8", and three 7/8" knockouts and four Romex pryouts with strain relief



Non-IC Non-IC High Wattage

Item #: RH4/NLV

Order Code: 77667

Item #: RH4/NLV/HW

Order Code: 78340



Shallow Non-IC

Item #: RH4/NLV/S

Order Code: 78340

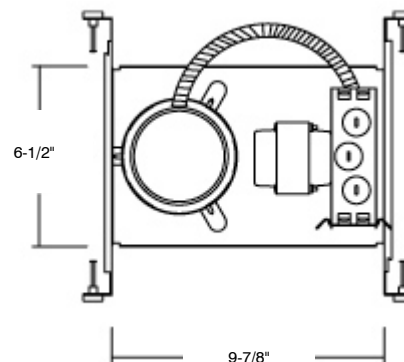
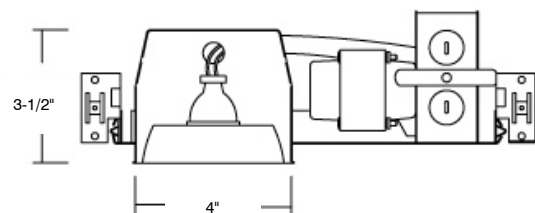
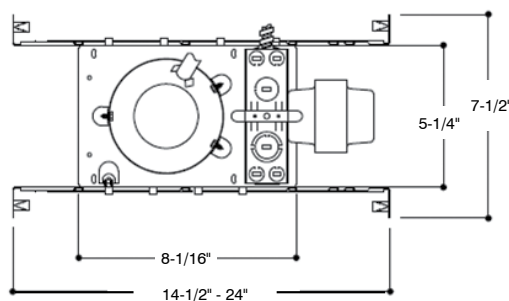
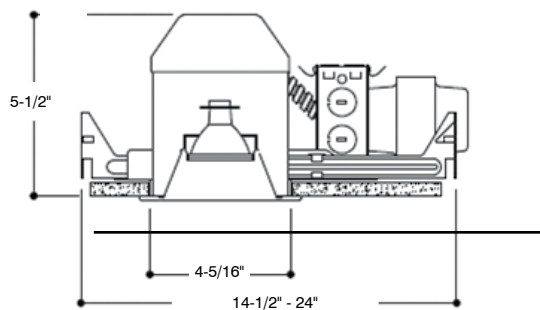

4" Low Voltage New Construction Housing

Features

- 50 watt max. 12V MR16
- Plaster frame: Galvanized steel construction. Housing can be removed from plaster frame to provide access to the junction box
- Housing: Double wall aluminum construction for greater heat dissipation. Gasketed to prevent airflow from heated or air conditioned space. Housing adjusts for ceiling up to 1-1/4" thick
- Transformer: 120V Integral magnetic transformer steps line voltage down to lamp operating voltage. For lamps up to 50W
- Thermal protector: Self resetting thermal protector deactivates fixture if overheating occurs due to improper lamping or misapplied insulation
- UL Listed for damp location
- UL Listed for feed through wiring
- Certified under ASTM-E283 for airtight construction

Installation

- Bar hanger: Pre-installed nails easily install in regular, or engineered lumber. Bar hangers are adjustable from 13-5/8" to 25" and can be repositioned 90 degrees on plaster frame
- Junction box: Listed for through branch circuit wiring. Contains seven 7/8" knockouts and four Romex pryouts with strain relief



IC Airtight

Item #: RH4/NLV/IC/AT

Order Code: 79138

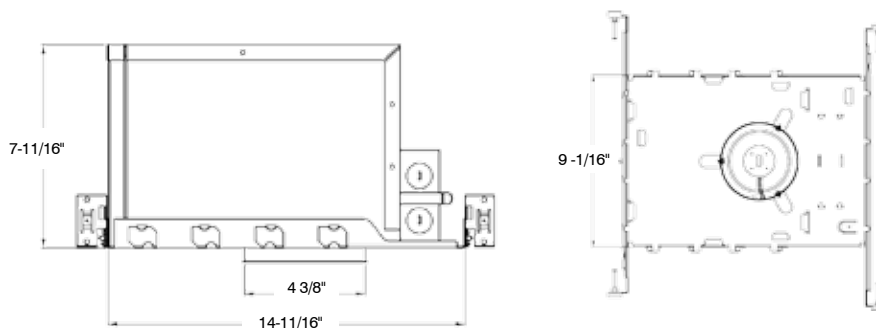

4" Low Voltage Remodel Construction Housing

Features

- 50 watt max 12V MR16 (RH4/RLV and RH4/RLV/S), 75 watt max 12V MR16 (RH4/RLV/HW)
- Thermal protector: Self resetting thermal protector deactivates fixture if overheating occurs due to improper lamping or misapplied insulation
- Remodel clips: Four remodel clips secure housing and accommodates 1/2" and 5/8" ceiling materials.
- Support spring: Support spring helps support weight of junction box and transformer. Automatically adjusts for different ceiling materials
- Transformer: 120V Integral magnetic transformer steps line voltage down to lamp operating voltage. For lamps up to 50W (RH4/RLV and RH4/RLV/S), and up to 75W (RH4/RLV/HW)
- UL Listed for damp location
- UL Listed for feed through wiring

Installation

- Junction box: Listed for through branch circuit wiring. (RH4/RLV) contains seven 7/8" knockouts and four Romex pryouts with strain relief. (RH4/RLV/HW and RH4/RLV/S) contains six 7/8" knockouts and four Romex pryouts with strain relief



Non-IC

Item #: RH4/RLV

Order Code: 77532

Non-IC High Wattage

Item #: RH4/RLV/HW

Order Code: 77668



Shallow Non-IC

Item #: RH4/RLV/S

Order Code: 79977

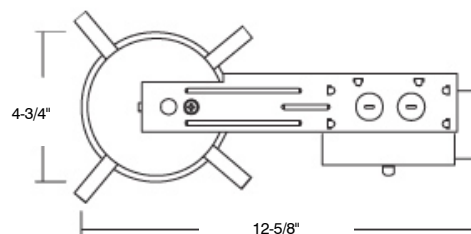
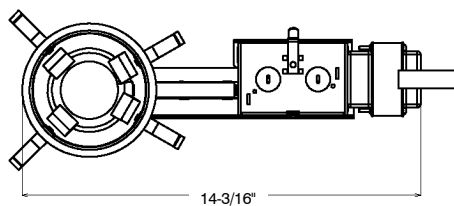
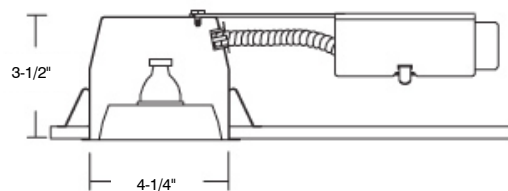
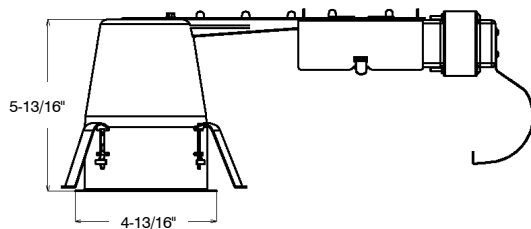

3" and 4" Low Voltage Trims

3" Trims



RT301SN

All Satin Nickel Baffle Trim
Uses 50W 12V MR16 Lamps
Order Code: 79950

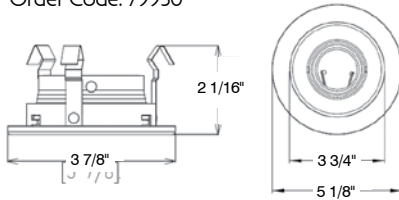

4" Trims



RT400CL/CH/LV

Clear Reflector with Chrome Ring
Uses 50W 12V MR16 Lamps
Order Code: 78161

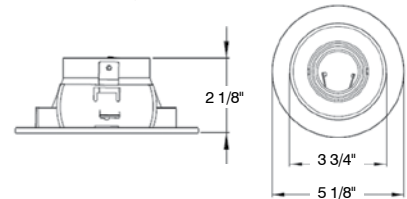

RT332WH

Round White Gimbal
Uses 50W 12V MR16 Lamps
Order Code: 78131

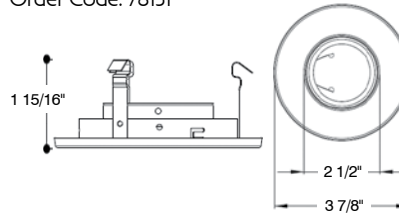

RT400CL/WH/LV

Clear Reflector with White Ring
Uses 50W 12V MR16 Lamps
Order Code: 78356

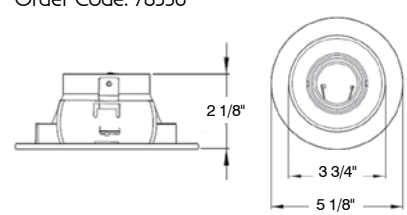

RT301WH

White Baffle with White Ring
Uses 50W 12V MR16 Lamps
Order Code: 79611

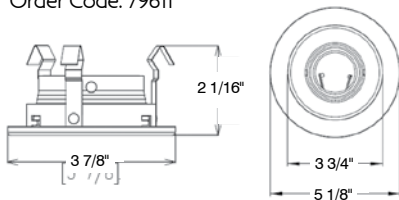

RT400WH/LV

White Reflector with White Ring
Uses 50W 12V MR16 Lamps
Order Code: 79128

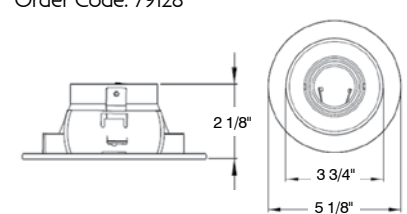

RT332SN

Round Satin Nickel Gimbal
Uses 50W 12V MR16 Lamps
Order Code: 79952

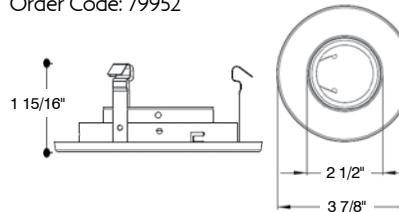

RT401BL/LV

All Steel Black Baffle with Black Ring
Uses 50W 12V MR16 Lamps
Order Code: 78729

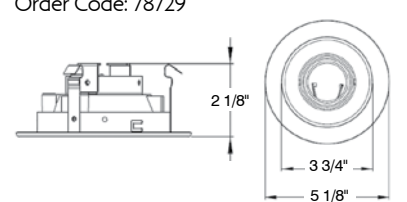

4" Low Voltage Trims



RT401BL/WH/LV

All Steel Black Baffle with White Ring
Uses 50W 12V MR16 Lamps
Order Code: 79262

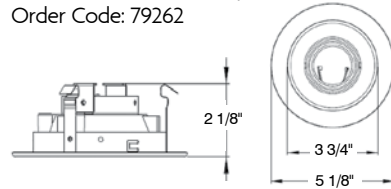

RT408BL/LV

Black Slot Aperture
Uses 50W 12V MR16 Lamps
Order Code: 78166

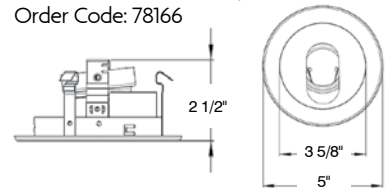

RT401SCH/LV

All Steel Satin Baffle with Satin Ring
Uses 50W 12V MR16 Lamps
Order Code: 78159

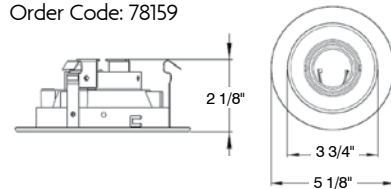

RT408WH/LV

White Slot Aperture
Uses 50W 12V MR16 Lamps
Order Code: 78165

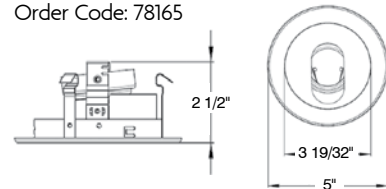

RT401WH/LV

All Steel White Baffle with White Ring
Uses 50W 12V MR16 Lamps
Order Code: 79127

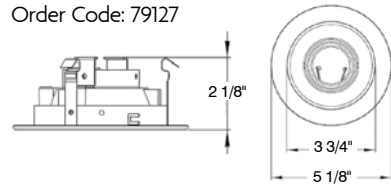

RT409WH/DO/LV

Drop Opal Shower Trim
Uses 50W 12V MR16 Lamps
Order Code: 78178

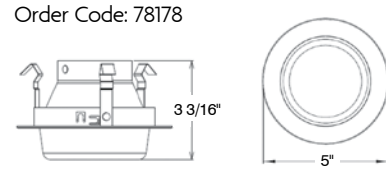

RT406WH/LV

Shallow White Baffle with White Gimbal
Uses 50W 12V MR16 Lamps
Order Code: 77669

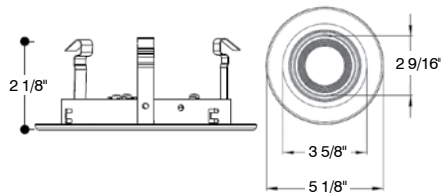

RT409WH/FL/LV

Fresnel Glass with White Trim
Uses 50W 12V MR16 Lamps
Order Code: 77670

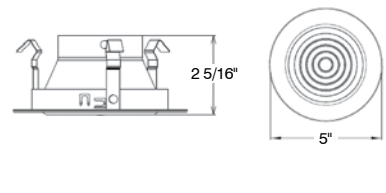

RT407WH/LV

White Pin Hole
Uses 50W 12V MR16 Lamps
Order Code: 72020

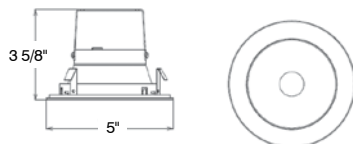

RT413BL/BL/LV

Deep Black Baffle with Black Eyeball
Uses 50W 12V MR16 Lamps
Order Code: RT413BL/BL/LV

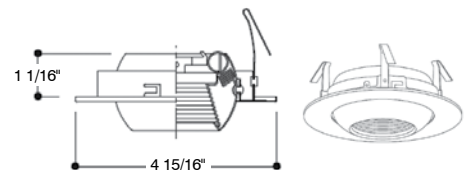

4" Low Voltage Trims



RT413WH/LV

Deep White Baffle with White Eyeball
Uses 50W 12V MR16 Lamps
Order Code: 78362

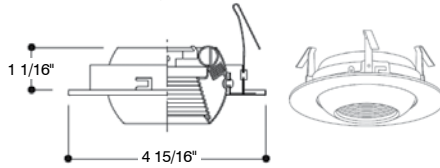

RT431WH/LV

Deep White Baffle with Round White Gimbal
Uses 50W 12V MR16 Lamps
Order Code: 431WH/LV

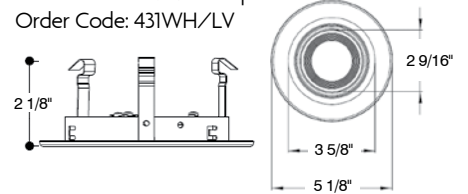

RT421WH/LV

All White Baffle Wall Wash
Uses 50W 12V MR16 Lamps
Order Code: 78279

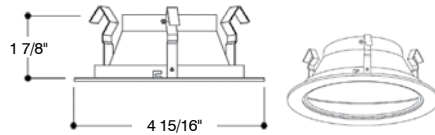

RT432NK/LV

Round Brushed Nickel Gimbal
Uses 50W 12V MR16 Lamps
Order Code: 78176

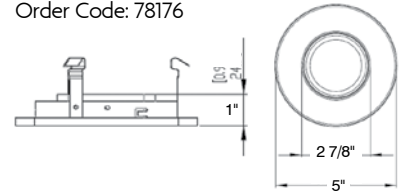

RT422CH/LV

Chrome Square Gimbal with Chrome Square Body
Uses 50W 12V MR16 Lamps
Order Code: 78171

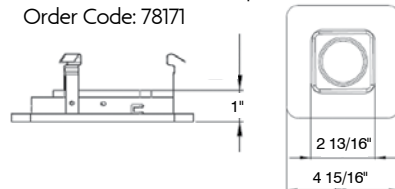

RT432WH/LV

Round White Gimbal
Uses 50W 12V MR16 Lamps
Order Code: 79169

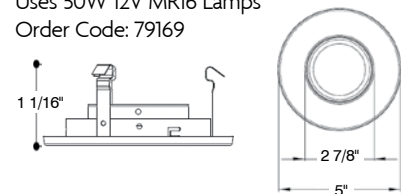

RT422WH/LV

White Square Gimbal with White Square Body
Uses 50W 12V MR16 Lamps
Order Code: 77534

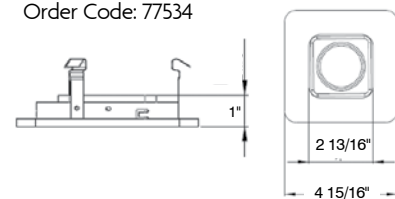

RT436NK/LV

Die-cast Nickel Rotating Beacon
Uses 50W 12V MR16 Lamps
Order Code: RT436NK/LV

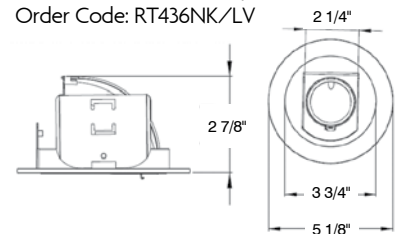

RT431BL/LV

Deep Black Baffle with Round Black Gimbal
Uses 50W 12V MR16 Lamps
Order Code: RT431BL/LV

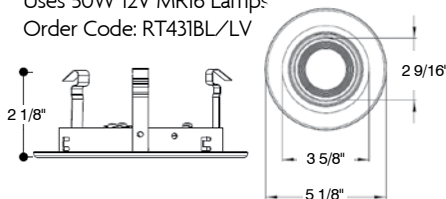

RT436WH/LV

Die-cast White Rotating Beacon
Uses 50W 12V MR16 Lamps
Order Code: 79554

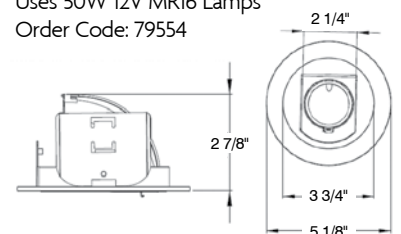

Accessories



RFA-ADPT-E26-E26
Ceramic Extension Socket (E26-E26)
Order Code: 78230



RFA-C-HB
2 piece set of C-Channel Hanger Bars
Order Code: 77966



RFA-ADPT-E26-GU24
Socket Adapter (E26-GU24)
Order Code: 78228



RFA-LV-XFMR-50
120V to 12VAC/50W
Magnetic Replacement Transformer
Mounted on J-box Cover
(For use with recessed housings
RH4/NLV and RH4/RLV)
Order Code: 77530



RFA-CLIP
Universal Remodel Clips (Set)
Order Code: 78218

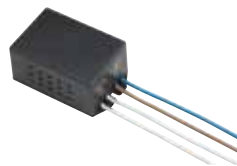

RFA-LV-XFMR-50EL/220
220V to 12VAC/50W
Electronic Replacement Transformer
(Not for use with recessed housings)
Order Code: 78227



RFA-LV-GC
Glass Cover for Louver Trim
Order Code: 72111



RFA-LV-XFMR-50EL
120V to 12VAC/50W
Electronic Replacement Transformer
(Not for use with recessed housings)
Order Code: 78225



RFA-HB
1 Set Male-Female Hanger Bar
Order Code: 75099



RFA-LV-XFMR-75EL
120V to 12VAC/75W
Electronic Replacement Transformer
(Not for use with recessed housings)
Order Code: 78226

Accessories



RFA-SKT-GU10
GU10 Socket
Order Code: 78219



RFA-SPRING
Straight Coil Spring
Order Code: 74100

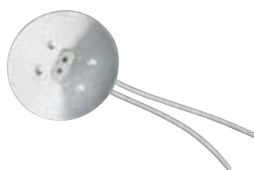

RFA-SKT-GU5.3
MR16 Socket with Heat Shield
Order Code: 72110



RFA-TR-OV6-BL
8-1/2" Black Ring
Order Code: 78221



RFA-SKT-TP-E26
Base Plate with Removable Socket
and Thermal Protector
Order Code: 78215



RFA-TR-OV6-BR
8-1/2" Brass Ring
Order Code: 78223



RFA-SPR-V
Torsion Spring
Order Code: 78217



RFA-TR-OV6-C
8-1/2" Chrome Ring
Order Code: 78222

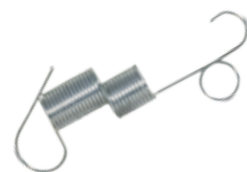

RFA-SPR-COIL
Split Coil Spring
Order Code: 74101



RFA-TR-OV6-W
8-1/2" White Ring
Order Code: 74104

Nomenclature

Housings

Series	Aperture Size	Lamp Orientation	Construction	Lamp Style	# of Lamps	Lamp Wattage	Insulation Contact	Airtight	Voltage	Options
RH = Recessed Housing	3	Blank = Vert	Blank = Standard Depth Housing	Blank = Incand.	1 or 2	Blank = Incand.	Blank = Non-IC	Blank = Non-AT	Blank = 120	Any
	4	H = Hor	R = Remodel	C = CFL		Insert wattages for CFL, GU	IC = IC	AT = AT	H = 120/277	Modifications
	5		N = New	G = GU					HW = High Wattage	
	6		S = Shallow SL = Slope SSL = Super Slope	LV = Low Voltage						

Trims

Series	Aperture Size	2X #	Trim Color	Ring Color	Lamp Type/ Wattage	Airtight	Options
RT = Recessed Trim	3	See Below	WH = White	Blank = Same color as trim	Blank = Incandescent	Blank = Non-AT or insert 'AT'	Used for trims with both plastic and metal rings, different lensing, etc
	4		BL = Black	WH = White	C = CFL		
	5		CH = Chrome	BL = Black	G = GU		
	6		NK = Satin Nickel CL = Clear GO = Gold	CH = Chrome NK = Satin Nickel	LV = Low Voltage		

Trim Numbering System

00 = Smooth Reflector	04 = Open Ring	08 = Slot	12 = Deep Baffle	16 = Deep Gimbal	20 = Wall Wash
01 = Baffle	05 = Open Ring	09 = Shower	13 = Baffle Eyeball	17 = Shallow Baffle	21 = Baffle Wall Wash
02 = Baffle	06 = Gimbal	10 = Deep Smooth Reflector	14 = OPEN	18 = OPEN	
03 = Eyeball	07 = Pin Hole	11 = Deep Reflector w/Baffle	15 = OPEN	19 = Deep Shower	



The Topaz Difference

At Topaz you get a personal assistant assigned to your account—a single point of contact to rely on to get 100% of your needs met...fast. In addition to our award winning service, we are committed to providing you with:

VALUE PRICING – As a manufacturer, we believe in providing you with quality products, value priced, so that both you and your customers can benefit and grow your businesses.

DIRECT SHIPMENTS – There are times when your customer may need a product in a hurry. At your request, we will ship directly to your customers from our warehouse.

Topaz also delivers key value-added services to make sure you can serve your customers better.



We are well known for the depth and breadth of our inventory. FullFill reflects our promise that we can fill over 99% of the orders we receive from existing inventory.



Just give us your order by 4PM and in most cases, we will get your order out before 5PM on the same day.

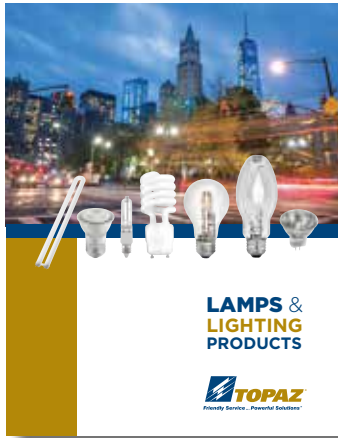

To see our complete product line visit us at ...

www.topaz-usa.com



Index

BEL12/12-48V	7, 39	F-L22/40/835/D/HE	7	RFA-ADPT-E26-GU24	96
F-ARL/150W/50K/SF	53	F-L22/40/840/D/HE	7	RFA-C-HB	96
F-ARL/300W/50K/SF	53	F-L22/40/850/D/HE	7	RFA-CLIP	96
F-ARL/150W/50K/TR	53	F-L24/38/830/D/HP	7	RFA-LV-GC	96
F-ARL/300W/50K/TR	53	F-L24/38/835/D/HP	7	RFA-HB	96
F-AWP-30/50K/BZ	41	F-L24/38/840/D/HP	7	RFA-LV-XFMR-50	96
F-AWP-40/50K/BZ	41	F-L24/38/850/D/HP	7	RFA-LV-XFMR-50EL	96
F-AWP-70/50K/BZ	41	F-L24/50/835/D/HE	7	RFA-LV-XFMR-50EL/220	96
F-AWP-90/50K/BZ	41	F-L24/50/840/D/HE	7	RFA-LV-XFMR-75EL	96
F-CNPY-45WLED-LP	47	F-L24/50/850/D/HE	7	RFA-SKT-GU10	97
F-CNPY-70WLED-LP	47	F-L2X2-FRAME	7	RFA-SKT-GU5.3	97
F-CNPY-RND40W/50K-BZ	49	F-L2X4-FRAME	7	RFA-SKT-TP-E26	97
F-CNPY-RND40W/50K-WH	49	F-L4/40W/40K/D	14	RFA-SPR-COIL	97
F-CNPY-RND60W/50K-BZ	49	F-L4/40W/50W/D	14	RFA-SPRING	97
F-CNPY-RND60W/50K-WH	49	F-LED/4/36W/40/D	13	RFA-SPR-V	97
F-D2D-45WLED KIT	51	F-LED-CABLE 4PK	7	RFA-TR-OV6-BL	97
F-D2D-70WLED KIT	51	F-LED-CABLE 6PK	7	RFA-TR-OV6-BR	97
F-D2D-70WLED KIT-80G	51	F-LHB160/50K/480V	17	RFA-TR-OV6-C	97
F-FL/PL-ADPT-90DEG	53	F-LHB160/50K/UNV	17	RFA-TR-OV6-W	97
F-FL/PL-ADPT-SQ-RND	53	F-LUHB/150/50K	18	RH3/NLV	88
F-FL/PL-POLE MOUNT	53	F-LUHB150/50/HT	19	RH3/NLV/IC/AT	88
F-FL/WP-40WLED	37	F-LUHB150/50/HT/480V	19	RH3/NLV/S	89
F-FL/WP-60WLED	37	F-LUHB150/50/HTS	19	RH3/RLV/S	89
F-FL-13/50K/KN/BZ	35	F-LUHB150/50/HTS/480	19	RH4/N	56
F-FL-30/50K/KN/BZ	35	F-LWRAP/42W/40K	15	RH4/N/IC/AT	56
F-FL-50/50K/TR/BZ	35	F-LWRAP/42W/50K	15	RH4/NG	76
F-FLC-20WLED	33	F-VTA22/40/835/D	9	RH4/NG/118/IC/AT	80
F-FL-KNMOUNT	37	F-VTA22/40/840/D	9	RH4/NG/IC/AT	76
F-FL-SFMOUNT	37	F-VTA22/40/850/D	9	RH4/NLED/IC/AT	29
F-FL-TRMOUNT	37	F-VTA24/65/835/D	9	RH4/NLV	90
F-FM6/10/RN/P/30/WH	21	F-VTA24/65/840/D	9	RH4/NLV/HW	90
F-FM8/12/RN/P/30/WH	21	F-VTA24/65/850/D	11	RH4/NLV/IC/AT	91
F-FM10/15/DC/P/30/BN	21	F-VTC22/30/835/D	11	RH4/NLV/S	90
F-FM11/15/FN/G/30/BN	21	F-VTC22/30/840/D	11	RH4/R/AT	57
F-FM11/15/RN/P/30/WH	21	F-VTC22/30/850/D	11	RH4/RG	77
F-FM11/15/TL/G/30/BN	21	F-VTC24/45/835/D	11	RH4/RG/118/IC/AT	81
F-FM11/15/TL/G/30/WH	21	F-VTC24/45/840/D	11	RH4/RLED/IC/AT	28
F-FM12/20/DC/P/30/BN	21	F-VTC24/45/850/D	11	RH4/RLV	92
F-FM14/22/DC/P/30/BN	21	F-WP-135LED/50K	39	RH4/RLV/HW	92
F-L14/32/830/D/HP	7	F-WP-45LED/50K	39	RH4/RLV/S	92
F-L14/32/835/D/HP	7	F-WP-70LED/50K	39	RH5/N/IC/AT	60
F-L14/32/840/D/HP	7	F-WP-90LED/50K	39	RH5/NLED/IC/AT	29
F-L14/32/850/D/HP	7	F-WPM-40WLED-FC	43	RH5/R/IC/AT	61
F-L1X4-FRAME	7	F-WP-PHOTOCCELL	39	RH5/RLED/IC/AT	28
F-L22/32/830/D/HP	7	F-WPS-17WLED	45	RH6/N/IC/ATS	62
F-L22/32/835/D/HP	7	F-WPS-17WLED-WH	45	RH6/N/IC/ATS/FL	62
F-L22/32/840/D/HP	7	F-WPS-29WLED	39	RH6/N/ICS	63
F-L22/32/850/D/HP	7	RFA-ADPT-E26-E26	96	RH6/N/S/IC	64

Index

RH6/N/S/IC/AT	64	RT421WH	59	RT609WH/FL	70, 84
RH6/NG/126/IC/AT	80	RT421WH/LV	95	RT609WH/FL/P	70, 84
RH6/NLED/IC/AT	29	RT422CH/LV	79, 95	RT609WH/FR/P	70, 84
RH6/NSL/IC/AT	72	RT422WH/LV	79, 95	RT610CL/WH	70, 84
RH6/NSL/IC/BOX	73	RT429WH	59	RT611BL/WH	84
RH6/R/IC	65	RT431BL/LV	95	RT611WH	70, 85
RH6/R/IC/AT	65	RT431WH/LV	95	RT612WH	70, 85
RH6/R/S	66	RT432CH/LV	79	RT613WH/R	71
RH6/R/S/IC	67	RT432NK/LV	95	RT614C	85
RH6/R/S/IC/AT	67	RT432WH/LV	79, 95	RT614GW	71, 85
RH6/RG/126/IC/AT	81	RT436NK/LV	95	RT619WH/A/P	85
RH6/RLED/IC/AT	28	RT436WH/LV	95	RT620WH	85
RH6/RSL/IC/AT	74	RT500CL/WH	61	RT621WH	85
RT301SN	93	RT501WH	61	RTL/420WH/ECO/D	27
RT301WH	93	RT502WH	61	RTL/423WH/90/D	26
RT332SN	93	RT509WH/A	61	RTL/430WH/ECO/D	27
RT332WH	93	RT509WH/FL	61	RTL/433WH/90/D	26
RT400CL/CH/LV	93	RT600CL/CH/R30	68	RTL/437WH/90/D	25
RT400CL/WH	58	RT600CL/WH/R30	68	RTL/43SQ/WH/90/D	24
RT400CL/WH/LV	78, 93	RT600CL/WH/R40	68	RTL/440WH/ECO/D	27
RT400WH	58	RT600CL/WH/SC	75	RTL/443WH/90/D	26
RT400WH/LV	78, 93	RT600GO/WH/R30	68	RTL/447WH/90/D	25
RT401BL	58	RT600WH/R30	68, 83	RTL/445SQ/WH/90/D	24
RT401BL/BAFF	58	RT601BL	68, 83	RTL/450WH/ECO/D	27
RT401BL/CH	58	RT601BL/WH	68, 83	RTL/620WH/ECO/D	27
RT401BL/LV	78, 93	RT601SCH	68, 83	RTL/623WH/90/D	26
RT401BL/PB	58	RT601WH	68, 83	RTL/630WH/ECO/D	27
RT401BL/WH	58	RT602BL	68	RTL/633WH/90/D	26
RT401BL/WH/LV	78, 94	RT602BL/WH	69	RTL/637WH/90/D	25
RT401SCH/LV	94	RT602BL/WH/AT	69	RTL/635SQ/WH/90/D	24
RT401WH	58	RT602BL/WH/SC	75	RTL/640WH/ECO/D	27
RT401WH/LV	78, 94	RT602GW/AT	69	RTL/643WH/90/D	26
RT403BL	59	RT602GW/AT/FS	69	RTL/647WH/90/D	25
RT403WH	59	RT602SCH	69	RTL/645SQ/WH/90/D	24
RT406BL	59	RT602WH	69	RTL/650WH/ECO/D	27
RT406WH	59	RT602WH/AT	69	RTLED/RETRO/GU24	28
RT406WH/LV	94	RT602WH/SC	75	SDL4/12/930/D	23
RT407WH/LV	94	RT603BL	69	SDL4/12/930/D/CC	23
RT408BL/LV	78, 94	RT603WH	69	SDL4/12/940/D	23
RT408WH/LV	78, 94	RT603WH/WH/SC	75	SDL4/12/940/D/CC	23
RT409WH/A	59	RT604BL/WH/SC	75	SDL6/15/930/D	23
RT409WH/DO/LV	94	RT604SCH	69	SDL6/15/930/D/CC	23
RT409WH/FL	59	RT604WH	70	SDL6/15/940/D	23
RT409WH/FL/LV	94	RT604WH/SC	75	SDL6/15/940/D/CC	23
RT410CL/WH/G	82	RT605WH	70	WD-SP	39
RT412WH/G	82	RT609WH/A	70, 84		
RT413BL/BL/LV	94	RT609WH/A/P	70, 84		
RT413WH/LV	78, 95	RT609WH/DO/P	84		

Topaz Limited Warranty

Topaz Lighting Corp. (hereinafter called "Topaz"), 925 Waverly Avenue, Holtsville, NY 11742, warrants to the purchaser that Topaz lamps will be free from defect in material and/or workmanship from the date of purchase for the following time periods:

Category	Warranty*
Compact Fluorescent	2 Years
LED A19 ECO:	3 Years
LED Filament:	3 Years
LED A-Shape:	5 Years
LED Globe:	5 Years
LED Indoor Reflector:	5 Years
LED Linear:	5 Years
LED Luminaire:	5 Years
LED Mini-Reflector:	5 Years
LED PAR:	5 Years
LED Plug-in Style:	5 Years
LED Post Top Light:	5 Years
LED Retrofit Unit:	5 Years
LED Surface Mount Light:	5 Years

All other lamps are covered under our Quality Policy.

LIMITED WARRANTY: Topaz Lighting Corp. warrants to the original purchaser that Topaz lamps shall be free from defects of material and workmanship for a period as stated above from the date of purchase. Topaz Lighting Corp. will, at its option, repair or replace without charge a defective lamp that has not been misused, carelessly handled or improperly installed. Repair or replacement, as stated above, shall constitute the purchaser's exclusive warranty, which does not extend to transportation, installation, labor or any other incidental or consequential charges. www.topaz-usa.com.

*Based on maximum operating hours @ 12 hours/day

This warranty is not applicable to any lamp, which is not installed and operated in accordance with the current edition of the National Electric Code (NEC), the Standards for Safety of Underwriters Laboratory, Inc. (UL), the Standards for the American National Standards Institute (ANSI) and with Topaz instructions and guidelines for the lamp. This warranty is not applicable to any lamp subjected to abnormal stresses and operating conditions. Use of occupancy sensors, dimmers or programmable systems with some lamp types may void the warranty.

Topaz reserves the right to examine all lamps prior to the determination of warranty status. All lamps must be retained for warranty claims. The warranty period starts on the date of installation. If the date of installation cannot be determined or is unknown, the warranty period will start with the date of the original purchase from Topaz.

Warranty Exclusion Clause for Products Exported:

This warranty shall be void for products that are exported outside the U.S. and its territories. The distributor, private labeler or OEM assumes all responsibility imposed by statute, regulation or law on product sold into those markets.

NO IMPLIED STATUTORY WARRANTY OF MERCHANTABILITY OR FITNESS FOR A PARTICULAR PURPOSE SHALL APPLY BEYOND THE AFOREMENTIONED WARRANTY PERIOD.

The foregoing warranty is exclusive of all other statutory, written or oral warranties, and no other warranties of any kind, statutory or otherwise, are given or herein expressed. The warranty sets forth Topaz's responsibilities regarding the lamp and claimant's exclusive remedy.

LIMITATION OF LIABILITY: Topaz will not under any circumstances, whether as a result of breach of contract, breach of warranty, tort, strict liability or otherwise, be liable for consequential, incidental, special or exemplary damages including, but not limited to, loss of profits or revenues, loss of use of lamp or any other goods or associated equipment or damage to any associated equipment, cost of capital, cost of substitute products, facilities of service, down time cost, or claims of claimant's customers. Topaz's liability on any claim of any kind for any loss or damages arising out of, resulting from or concerning any aspect of this agreement from the products or services furnished hereunder shall not exceed the price of the specific lamp or lamps which gives rise to the claim. Some states do not allow the exclusion or limitation of damages or the length of time for an implied warranty. Therefore, the limitations or exclusions of consequential or incidental damages and implied warranties may not apply to certain claimants. This warranty gives the claimant specific legal rights. The claimant may also have other rights, which vary from state to state.

QUALITY POLICY: Topaz is committed to providing excellent service and high quality products that fully meet and exceed established requirements. We are committed to continually improving the effectiveness of the overall Quality Management System. We will achieve this through the process of defining, understanding, as well as agreeing and conforming to customer requirements. Topaz proudly stands behind its motto "*Friendly Service ... Powerful Solutions.*"



Topaz is committed to providing excellent service and high quality products that fully meet and exceed established requirements. We will achieve this through the process of defining, understanding, as well as agreeing and conforming to customer requirements. Topaz proudly stands behind its motto "Friendly Service ... Powerful Solutions."

©2017 Topaz Lighting Corp. All rights reserved. All sizes and specifications are subject to change.



NY Office

925 Waverly Avenue
Holtsville, NY 11742
800.666.2852
Fax | 631.758.8026

CA Office

225 Parkside Drive
San Fernando, CA 91340
888.551.2852 or 818.838.3123
Fax | 888.690.2852 or 818.838.3102

FL Office

3850 20th Street, Ste 600
Vero Beach, FL 32960
800.338.2852
Fax | 772.778.5386

info@topaz-usa.com | www.topaz-usa.com



LIGHTING FIXTURES



Friendly Service... Powerful Solutions™

About Topaz

Our Business

A family-owned, U.S.-based company, Topaz manufactures lamps, fixtures and electrical supplies for commercial and residential, indoor and outdoor applications. From stadium to specialty lighting, we deliver a world-class selection of the most energy efficient products on the market today.

What Have We Learned?

With over 30 years of experience in the lighting industry, Topaz knows a thing or two about what issues are important to our customers. We believe in offering an inventory of quality, energy efficient products with versatile applications at fair prices. We work hard to offer the most professional and friendliest customer service to all of our valued clients.

Staying Current in Today's Always-Evolving Marketplace

As the shape of the lighting industry continues to evolve, Topaz is firmly committed to staying ahead of the technological power curve. We are proud to showcase our updated and comprehensive line of fixtures and lighting products. Have questions? Our friendly and knowledgeable sales team will be happy to help you. Ready to place an order? Contact your Topaz representative today to see how Topaz products can work for you.





Table of Contents

LED Indoor Lighting

Flat Panels	6-7
Volumetric Troffers.....	8-11
Linear 36W Luminaire.....	12-13
Linear Strip and Wrap	14-15
Linear High Bay	16-17
UFO High Bay Lighting.....	18-19
Residential Flush Mount Fixtures	20-21
Surface Mount Disk Lights.....	22-23
Retrofit Units.....	24-27
New Construction/Remodel Housings.....	28-29

LED Outdoor Lighting

Compact Flood Light.....	32-33
Low Profile Flood Lights.....	34-35
Architectural Wall Pack/Flood Lights.....	36-37
Traditional Wall Packs	38-39
Architectural Slim Wall Packs	40-41
Full Cutoff Wall Pack.....	42-43
Small Wall Packs.....	44-45
Canopy and Parking Garage Lights	46-47
Round Canopy Lights	48-49
Dusk-to-Dawn.....	50-51
Parking Lot/Area Lights.....	52-53

Line Voltage Recessed Downlighting

4" Line Voltage	56-59
5" Line Voltage	60-61
6" Line Voltage	62-71
6" Line Voltage for Sloped Ceilings	72-75
4" GU10	76-79
4" and 6" GU24	80-85

Low Voltage Recessed Downlighting

3" and 4" Low Voltage	88-95
-----------------------------	-------

Accessories	96-97
--------------------------	-------

Nomenclature	98
---------------------------	----

Index	100-101
--------------------	---------

Warranty	102-103
-----------------------	---------



LED Indoor Lighting

Topaz's indoor LED fixtures are the perfect long life alternative to traditional lighting technologies. By reducing energy and maintenance costs, they offer a lower cost of ownership. Commercial options include flat panels, architectural style troffers and stylish linear luminaires. Residential products include a line of LED retrofits for recessed applications, flush mount ceiling fixtures and disk lights—all featured in attractive designs and finishes. Topaz's LED commercial and residential fixtures are available with either DLC® or ENERGY STAR® qualification.



LED Flat Panels

With edge-to-edge, evenly diffused, glare-free light, Topaz's LED Flat Panels provide a contemporary solution to replace inefficient fluorescent fixtures. Available in 3000K (warm white), 3500K (neutral white), 4000K (cool white) and 5000K (daylight) correlated color temperatures, our LED Flat Panels cast the right light in any commercial setting. Designed for drop-in ceilings or surface mount installations, the slim profile fixtures are available in 1' x 4', 2' x 2' or 2' x 4' sizes and can save up to 50% of energy usage compared to traditional fluorescent fixtures. Standard 0-10V dimming capability allows greater energy-savings and optional emergency backup available for 90 minutes of uninterrupted service during a power loss.



1' x 4'

2' x 2'

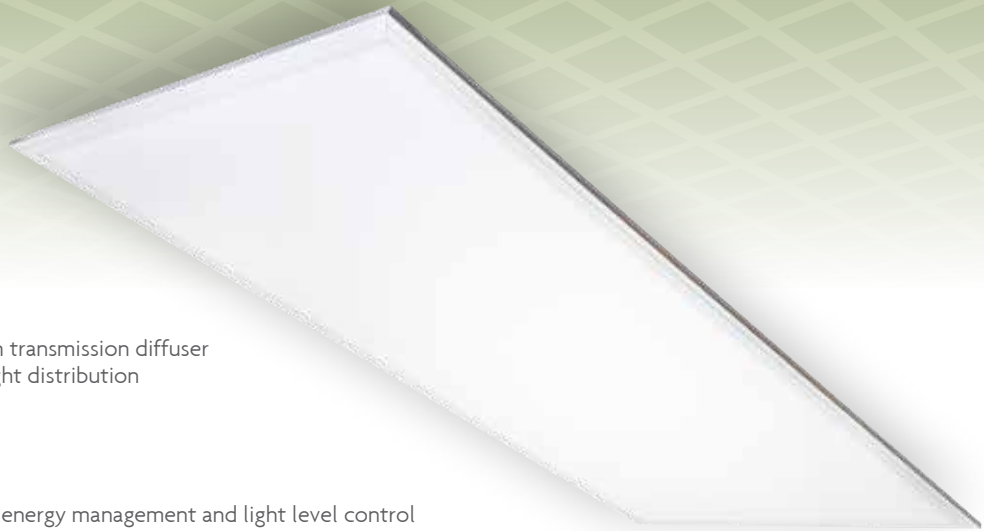

2' x 4'

Features

- LED edge lit design with high transmission diffuser providing even, glare-free light distribution
- PMMA light guide
- White frame construction
- PF >0.9 and THD <15%
- Standard 0-10V dimming for energy management and light level control
- Luminous efficacy of up to 130 Lumens/Watt
- Emergency back-up options available
- Applications: Schools, hospitals and offices

Item #	Order Code	Size (ft)	Volts	Watts	Lumens	LPW	CCT (Kelvin)	CRI	Beam Angle	Dimmable	DLC
High Performance 1' x 4'											
F-L14/32/830/D/HP	72800	1' x 4'	120-277VAC	32	3,400	106	3000	80	150°	0-10V	Y
F-L14/32/835/D/HP	72802	1' x 4'	120-277VAC	32	3,450	108	3500	80	150°	0-10V	Y
F-L14/32/840/D/HP	72804	1' x 4'	120-277VAC	32	3,550	111	4000	80	150°	0-10V	Y
F-L14/32/850/D/HP	72806	1' x 4'	120-277VAC	32	3,600	113	5000	80	150°	0-10V	Y
High Performance 2' x 2'											
F-L22/32/830/D/HP	70944	2' x 2'	120-277VAC	32	3,400	106	3000	80	150°	0-10V	Y
F-L22/32/835/D/HP	70945	2' x 2'	120-277VAC	32	3,450	108	3500	80	150°	0-10V	Y
F-L22/32/840/D/HP	70946	2' x 2'	120-277VAC	32	3,550	111	4000	80	150°	0-10V	Y
F-L22/32/850/D/HP	70947	2' x 2'	120-277VAC	32	3,600	113	5000	80	150°	0-10V	Y
High Performance 2' x 4'											
F-L24/38/830/D/HP	70948	2' x 4'	120-277VAC	38	4,200	111	3000	80	150°	0-10V	Y
F-L24/38/835/D/HP	70949	2' x 4'	120-277VAC	38	4,250	112	3500	80	150°	0-10V	Y
F-L24/38/840/D/HP	70950	2' x 4'	120-277VAC	38	4,350	114	4000	80	150°	0-10V	Y
F-L24/38/850/D/HP	70951	2' x 4'	120-277VAC	38	4,400	116	5000	80	150°	0-10V	Y
High Efficiency 2' x 2'											
F-L22/40/835/D/HE	73347	2' x 2'	120-277VAC	40	4,800	120	3500	80	150°	0-10V	Y
F-L22/40/840/D/HE	73348	2' x 2'	120-277VAC	40	5,200	130	4000	80	150°	0-10V	Y
F-L22/40/850/D/HE	73349	2' x 2'	120-277VAC	40	5,200	130	5000	80	150°	0-10V	Y
High Efficiency 2' x 4'											
F-L24/50/835/D/HE	73350	2' x 4'	120-277VAC	50	6,000	120	3500	80	150°	0-10V	Y
F-L24/50/840/D/HE	73351	2' x 4'	120-277VAC	50	6,500	130	4000	80	150°	0-10V	Y
F-L24/50/850/D/HE	73352	2' x 4'	120-277VAC	50	6,500	130	5000	80	150°	0-10V	Y

Mounting Accessories (Sold separately)

Frame - Surface Mount Application

F-L1X4-FRAME	78628	1' x 4'	48" x 12" x 2.6"
F-L2X2-FRAME	78630	2' x 2'	24" x 24" x 2.6"
F-L2X4-FRAME	78631	2' x 4'	48" x 24" x 2.6"

Pendant Mount Cable

F-LED-CABLE 4PK	72710	2 x 2'
F-LED-CABLE 6PK	72712	1' x 4'

Emergency LED Driver

BEL12/12-48V	EL-1248-XXU
--------------	-------------

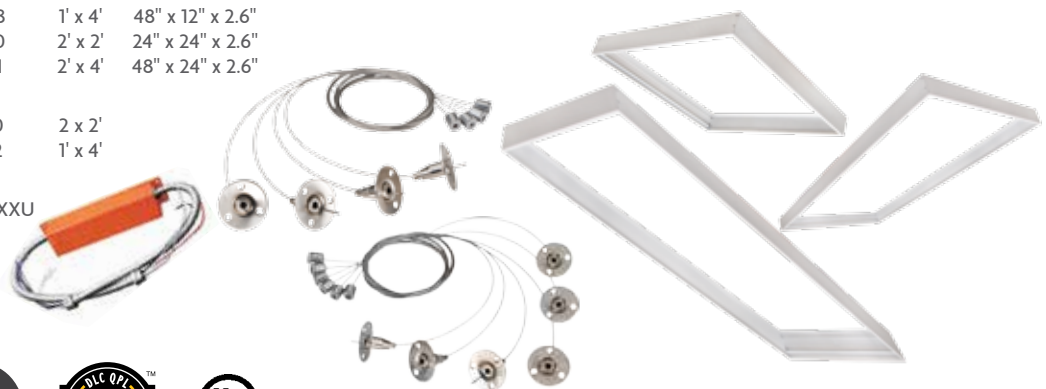



2' x 2'

LED Volumetric Troffers Architectural

Topaz's architectural style LED troffers are a high performance, optically efficient replacement to traditional fluorescent troffers. The aesthetically appealing design has been engineered to perform, delivering up to 110 lumens per watt (LPW) with a glare-free lens ideal for new construction or remodeling of commercial facilities. These troffers are DLC 4.1 Qualified and are available with standard 0-10V dimming. Perfect for offices, hospitals, schools and commercial applications.



2' x 4'

Features

- Architectural modern style with glare-free lens
- Center LED illumination with angled volumetric features for exceptional light distribution
- DLC 4.1 Qualified (4000K, 5000K) providing 110 LPW
- Compatible with 0-10V dimmers or control systems
- New construction or Retrofit for T-Grid installations
- Optional emergency backup available provides 90 minutes of temporary lighting

Item #	Order Code	Size (ft)	Volts	Watts	Lumens	LPW	CCT (Kelvin)	CRI	L70 Life	Beam Angle	Dimmable	DLC
2' x 2'												
F-VTA22/40/835/D	70934	2' x 2'	120-277V	40	4,000	100	3500	80	50,000	90°	0-10V	Pending
F-VTA22/40/840/D	70935	2' x 2'	120-277V	40	4,400	110	4000	80	50,000	90°	0-10V	Y
F-VTA22/40/850/D	70936	2' x 2'	120-277V	40	4,400	110	5000	80	50,000	90°	0-10V	Y
2' x 4'												
F-VTA24/65/835/D	70937	2' x 4'	120-277V	65	6,500	100	3500	80	50,000	90°	0-10V	Pending
F-VTA24/65/840/D	70938	2' x 4'	120-277V	65	7,150	110	4000	80	50,000	90°	0-10V	Y
F-VTA24/65/850/D	70939	2' x 4'	120-277V	65	7,150	110	5000	80	50,000	90°	0-10V	Y





2' x 2'

LED Volumetric Troffers Center Basket

Topaz's volumetric ARC style LED troffers are a high performance, optically efficient replacement to traditional fluorescent. The aesthetically appealing curved lens fills the room with unobstructed light. Engineered to perform, the glare-free lens delivers up to 130 LPW. These fixtures are ideal for new construction or remodeling of commercial facilities. DLC 4.1 Premium Qualified and with standard 0-10V dimming, these troffers are perfect for offices, hospitals, schools and commercial applications.



2' x 4'

Features

- Heavy duty steel construction with gloss white enamel finish
- Center LED illumination with ARC shape volumetric features for exceptional light distribution
- DLC 4.1 Premium Qualified providing up to 130 LPW
- Compatible with 0-10V dimmers or control systems
- New construction or retrofit for T-Grid installations
- Optional emergency backup available provides 90 minutes of temporary lighting
- Ideal for use in offices, schools, hospitals and other commercial applications

Item #	Order Code	Size (ft)	CCT (Kelvin)	Volts	Watts	Lumens	LPW	CRI	Avg. Rated Life	Beam Angle	Dimmable	DLC
2' x 2'												
F-VTC22/30/835/D	72741	2' x 2'	3500	120-277V	30	3,750	125	80	50,000	110°	0-10V	Y
F-VTC22/30/840/D	72742	2' x 2'	4000	120-277V	30	3,800	130	80	50,000	110°	0-10V	Y
F-VTC22/30/850/D	72743	2' x 2'	5000	120-277V	30	3,900	130	80	50,000	110°	0-10V	Y
2' x 4'												
F-VTC24/45/835/D	72745	2' x 4'	3500	120-277V	45	5,625	125	80	50,000	110°	0-10V	Y
F-VTC24/45/840/D	72746	2' x 4'	4000	120-277V	45	5,700	130	80	50,000	110°	0-10V	Y
F-VTC24/45/850/D	72747	2' x 4'	5000	120-277V	45	5,850	130	80	50,000	110°	0-10V	Y





LED Linear 36W Luminaire

The Topaz LED linear 36W luminaire is a new generation of eco-friendly LED linear lights. With 4,400 lumens achieving over 120 lumens per watt, this lamp offers exceptional light output, illumination and energy-savings. Ideally suited for commercial applications including offices, classrooms, garages, hallways, health care and storage facilities, it can easily be surface mounted or suspended, providing additional savings in time and labor costs. UL Listed, DLC Qualified, and rated for 50,000 hours providing virtually maintenance-free service. Standard 0-10V dimming capability and leads the industry with a 5-year warranty.



Features

- Compact and stylish design
- High efficiency 120 lumens/watt
- >80 CRI
- UL, DLC, FCC
- Surface or suspended mount
- 0-10V dimmable
- Universal voltage (100-277V)
- 5-Year limited warranty

Item #	Order Code	Watts	Volts	CRI	CCT (Kelvin)	Lumens	Avg. Rated Life	MOL	DLC	Dimmable
F-LED/4/36W/40/D	79858	36	100-277V	>80	4000	4,400	50,000	47.3"	Y	0-10V



LED Linear Strip and Wrap

Topaz's Linear LED Wrap-Around and Strip Luminaires are the best energy efficient alternative solution for linear fluorescent fixtures. Standard size of 4 feet and designed to open up the room and distribute light spaciouly along both the vertical and horizontal work space. Provides suitable light without any of the maintenance issues associated with fluorescent tubes and ballasts. The Superior LED technology delivers consistent color and CRI for uniform and comfortable lighting. Installation is quick and simple when mounting onto the surface of the ceiling. Constructed with a durable steel housing body and LED lifetime rating of at least 50,000 hours.



Features

- Replacement for 2x32W T8
- 131 Lumens per watt (LPW)
- 120° Beam angle
- Steel housing with UV resistant powder coat finish
- 0-10V dimmable
- 5-Year limited warranty
- Ideal for retail, supermarket, industrial/warehouses, government, hospitals, school/institutions

Linear Strip (Available June 2017)

Item #	Order Code	Watts	Volts	CRI	CCT (Kelvin)	Total Lumens	Avg. Rated Life (L70)	MOL	DLC	Dimmable
F-L4/40W/40K/D	74191	40	100-277V	80	4000	5,240	50,000	48.35"	Pending	0-10V
F-L4/40W/50K/D	74192	40	100-277V	80	5000	5,240	50,000	48.35"	Pending	0-10V





Features

- Replacement for 2x32W T8
- 100 Lumens per watt (LPW)
- 120° Beam angle
- Steel housing with UV resistant powder coat finish
- Chain or surface mount
- Equipped with heat resistant prismatic lens
- 5-Year limited warranty
- Ideal for retail, supermarket, industrial/warehouses, government, hospitals, school/institutions

Linear Wrap (Available June 2017)

Item #	Order Code	Watts	Volts	CRI	CCT (Kelvin)	Lumens	Avg. Rated Life (L70)	MOL	DLC	Dimmable
F-LWRAP/42W/40K	74193	42	100-277V	80	4000	4,200	50,000	47.1"	Y	-
F-LWRAP/42W/50K	74194	42	100-277V	80	5000	4,200	50,000	47.1"	Y	-





LED Linear High Bay

Our Linear High Bay offers high performance at a great value. The linear high bay is a simple, streamlined design for replacement of fluorescent or HID high bay luminaires. This 4 foot linear high bay will save up to 75% power, delivers 20K lumens and is DLC qualified. Suitable for mounting heights up to 25 feet and equipped with hook and chains for mounting. Offered with standard universal voltage 120-277VAC or 480VAC and can be used with standard high bay motion sensors.



Features

- Replacement for 400W metal halide fixture
- 125 Lumens per watt (LPW)
- 0-10V Dimmable*
- Mounting includes V hook and 36" chain
- Stem, chain or pendant mount
- Steel housing with UV resistant powder coat finish
- Equipped with heat resistant clear acrylic lens
- 5-Year limited warranty

Optional Accessory



OCCUPANCY SENSOR

Item #: WD-OS
Order Code: 72700

Item #: WD-OS/480V
Order Code: 75100

Item #	Order Code	Watts	Volts	CRI	CCT (Kelvin)	Lumens	Avg. Rated Life (L70)	MOL	DLC	Dimmable
F-LHB160/50K/UNV	72726	160	100-277VAC	>70	5000	20,060	50,000	47.2"	Y	0-10V
F-LHB160/50K/480V	72724	160	480V	>70	5000	20,060	50,000	47.2"	Y	0-10V

*Dimming with standard 0-10V dimmer, such as Leviton IP710, DS710 or Lutron DVSTV



LED UFO High Bay Lighting

Upgrade your facility in style with Topaz's UFO style High Bay LED luminaires. Compact, lightweight for easy install and suitable for up to 25 foot mounting heights. DLC premium qualified and deliver approximately 19K lumens. The UFO is offered in two styles; an economical version or in high ambient temperature. Perfect for warehouses, gymnasiums and production assembly areas.



Features

- Replacement for 400W metal halide fixture
- Suitable for ambient temperature of -40 to 104°F
- 130 Lumens per watt (LPW)
- Ring mount included for chain or hook installation
- 0-10 Dimmable
- Polycarbonate impact resistant lens
- Material AL1070
- Includes 6 ft power and low voltage cable
- 110° beam angle
- 5-Year limited warranty

High Bay

Item #	Order Code	Watts	Volts	CRI	CCT (Kelvin)	Lumens	Avg. Rated Life (L70)	MOL	DLC	Dimmable
F-LUHB/150/50K	74130	150	100-277V	>80	5000	19,500	50,000	12.8"	Y	0-10V





Features

- Suitable for high temperature applications up to 140°F
- Suitable for food service and NSF certified
- Built-in cooling fins provide maximum heat dissipation
- Replacement for 400W metal halide fixture
- 127 Lumens per watt (LPW)
- Hook mount standard for ease of installation
- Polycarbonate heat and impact resistant lens
- Motion sensor version HTS available
- 5-Year limited warranty

High Bay - High Ambient Temperature (Available June 2017)

Item #	Order Code	Watts	Volts	CRI	CCT (Kelvin)	Lumens	Avg. Rated Life (L70)	MOL	DLC	Dimmable
F-LUHB150/50/HT	74132	150	100-277V	70	5000	19,113	50,000	18"	Pending	0-10V
F-LUHB150/50/HTS	74138	150	100-277V	70	5000	19,113	50,000	18"	Pending	0-10V
F-LUHB150/50/HT/480V	74137	150	480V	70	5000	19,113	50,000	18"	Pending	0-10V
F-LUHB150/50/HTS/480	74139	150	480V	70	5000	19,113	50,000	18"	Pending	0-10V



LED Residential Flush Mount Fixtures

Topaz's residential/multi-family flush mount ceiling fixtures are the perfect choice for illuminating hallways, bedrooms, kitchen, utility rooms and closets. Available in several attractive designs and finishes, these fixtures are an attractive and energy efficient choice over incandescent or compact fluorescent fixtures. LED flush mounts are ENERGY STAR Listed, and available in sizes of 6 inch through 14 inch in diameter.



F-FM11/15/FN/G/30/BN



F-FM11/15/RN/P/30/WH



F-FM10/15/DC/P/30/BN



F-FM12/20/DC/P/30/BN

F-FM14/22/DC/P/30/BN

F-FM8/12/RN/P/30/WH

F-FM6/10/RN/P/30/WH

F-FM11/15/TL/G/30/BN

F-FM11/15/TL/G/30/WH

Features

- Modern and attractive design offered in several finishes and lens options
- Suitable for residential and multi-unit settings
- New construction or replacement and compatible with standard dimming controls*
- Available in 3000K CCT and 80 CRI
- Ideal for use in hallways, kitchens, bedrooms in residential, hospitality and multi-unit complexes

*Compatible with standard forward phase line voltage dimmers. For best results use a dimmer that is designed for LED. For a complete list of recommended dimmers visit www.topaz-usa.com.

Item #	Order Code	Finish	Watts	Volts	CRI	CCT (Kelvin)	Lumens	MOD	Avg. Rated Life	ENERGY STAR	Dimmable	Incand. Equiv.
F-FM6/10/RN/P/30/WH	79013	White Polycarbonate	10	120V	80	3000	600	6"	50,000	Y	Y	60W
F-FM8/12/RN/P/30/WH	79015	White Polycarbonate	12	120V	80	3000	800	8"	50,000	Y	Y	75W
F-FM11/15/RN/P/30/WH	79004	White Polycarbonate	15	120V	80	3000	1,100	11"	50,000	Y	Y	100W
F-FM11/15/TL/G/30/WH	79024	White Frosted Glass, Twist Lock	15	120V	80	3000	1,000	11"	50,000	Y	Y	75W
F-FM11/15/TL/G/30/BN	79006	Brushed Nickel Frosted Glass, Twist Lock	15	120V	80	3000	1,000	11"	50,000	Y	Y	75W
F-FM11/15/FN/G/30/BN	79009	Brushed Nickel Frosted Glass	15	120V	80	3000	850	11"	50,000	Y	Y	100W
F-FM10/15/DC/P/30/BN	79021	Brushed Nickel Polycarbonate	15	120V	80	3000	1,100	10"	50,000	Y	Y	100W
F-FM12/20/DC/P/30/BN	79012	Brushed Nickel Polycarbonate	20	120V	80	3000	1,500	12"	50,000	Y	Y	(2) 60W
F-FM14/22/DC/P/30/BN	71002	Brushed Nickel Polycarbonate	22	120V	80	3000	1,540	14"	50,000	Y	Y	(2) 60W





6"
SDL6

LED Surface Mount Disk Lights

An easy-to-install downlight solution for new construction as well as retrofit applications, Topaz's surface mount LEDs are offered in standard 4" or 6" sizes and are designed to be mounted to most standard 4" J-boxes. Perfect for residential or commercial applications including bathrooms, closets, storage areas, hallways and living areas, they offer exceptional color rendering of 90 CRI and are available in 3000K and 4000K color temperatures. Dimmable down to 5% with standard incandescent or LED style leading edge dimmers, their optical design provides a wide beam greater than 105° with low glare. With a life rating of at least 36K hours, these fixtures greatly minimize the cost of ownership through reduced maintenance and lower utility costs. California Title 24 and ENERGY STAR Listed, these fixtures are wet location rated.



4"
SDL4

Features

- Surface mount to most 4" J-boxes
- Driver-on-board technology eliminates an external power supply
- Power factor >.99
- Dimmable down to 5%
- Suitable for damp or wet locations for shower or outdoor enclosed locations
- Color temperature 3000K and 4000K
- Up to 75% energy-savings over traditional incandescent sources
- Select models California JA8-2016 Compliant*

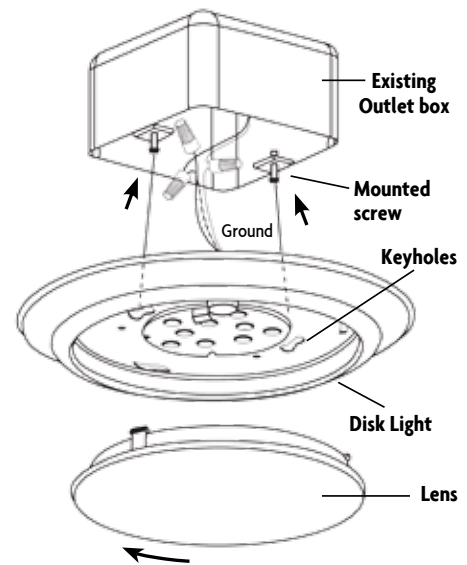

Item #	Order Code	Finish	Watts	Volts	CRI	CCT (Kelvin)	Lumens	Beam Angle	CBCP (cd)	MOD	Avg. Rated Life (L70)	ENERGY STAR	Dimmable	CA JA8
SDL4/12/930/D	70681	White	12	120V	90	3000	840	105°	223	5.8"	50,000	Y	Y	-
SDL4/12/940/D	70682	White	12	120V	90	4000	910	105°	223	5.8"	50,000	Y	Y	-
SDL6/15/930/D	70685	White	15	120V	90	3000	1,050	105°	342	7.4"	50,000	Y	Y	-
SDL6/15/940/D	70686	White	15	120V	90	4000	1,090	105°	342	7.4"	50,000	Y	Y	-
SDL4/12/930/D/CC*	74176	White	12	120V	90	3000	834	110°	223	5.9"	36,000	Y	Y	Y
SDL4/12/940/D/CC*	74177	White	12	120V	90	4000	834	110°	223	5.9"	36,000	Y	Y	Y
SDL6/15/930/D/CC*	74174	White	15	120V	90	3000	1,070	105°	342	7.4"	36,000	Y	Y	Y
SDL6/15/940/D/CC*	74175	White	15	120V	90	4000	1,070	105°	342	7.4"	36,000	Y	Y	Y



LED Retrofit Units

Topaz provides a high performance and easy-to-install retrofit solution for standard recessed housings. Models are available in 4" and 6" sizes for downlighting or directional applications. The units are dimmable down to 5% for optimal control and offer 90+ CRI for exceptional color rendering in 2700K-5000K. Constructed with advanced thermal management and optics, each unit is equipped with a power connector system for ease of installation. All units are ENERGY STAR and UL Listed for wet and/or damp locations. Topaz LED retrofit units are designed for reduced cost of ownership through lower energy and maintenance costs and have a life rating up to 50K hours.



Square

Item #	Order Code	Size	Voltage	Watts	CCT (Kelvin)	CRI	Lumens	Avg. Rated Life	ENERGY STAR	Dimmable	Wet Location
RTL/43SQ/WH/90/D	79715	4"	120V	10	3000	>90	715	50,000	Y	Y	Y
RTL/44SQ/WH/90/D	79717	4"	120V	10	4000	>90	760	50,000	Y	Y	Y
RTL/63SQ/WH/90/D	79263	6"	120V	16	3000	>90	1,000	50,000	Y	Y	Y
RTL/64SQ/WH/90/D	79265	6"	120V	16	4000	>90	1,100	50,000	Y	Y	Y





4"



5"/6"

Features

- Direct retrofit for existing trim/bulb combinations
- 90+ CRI models for exceptional color rendering
- Easy installation: unit screws into socket
- Dimmable down to 5% of total light output
- Available in different sizes and color temperatures for every application
- ENERGY STAR Listed
- Contains NO mercury

Gimbal

Item #	Order Code	Size	Voltage	Watts	CCT (Kelvin)	CRI	Lumens	Avg. Rated Life	ENERGY STAR	Dimmable	Damp Location
RTL/437WH/90/D	79707	4"	120V	8	3000	>90	620	50,000	Y	Y	Y
RTL/447WH/90/D	79709	4"	120V	8	4000	>90	690	50,000	Y	Y	Y
RTL/637WH/90/D	79711	5"/6"	120V	12	3000	>90	1,025	50,000	Y	Y	Y
RTL/647WH/90/D	79713	5"/6"	120V	12	4000	>90	1,100	50,000	Y	Y	Y



LED Retrofit Units



Baffles

Item #	Order Code	Size	Voltage	Watts	CCT (Kelvin)	CRI	Lumens	Avg. Rated Life	ENERGY STAR	Dimmable	Wet Location
RTL/423WH/90/D	79706	4"	120V	11	2700	>90	625	50,000	Y	Y	Y
RTL/433WH/90/D	79719	4"	120V	11	3000	>90	750	50,000	Y	Y	Y
RTL/443WH/90/D	79721	4"	120V	11	4000	>90	765	50,000	Y	Y	Y
RTL/623WH/90/D	79710	5"/6"	120V	15	2700	>90	1,020	50,000	Y	Y	Y
RTL/633WH/90/D	79723	5"/6"	120V	16	3000	>90	1,155	50,000	Y	Y	Y
RTL/643WH/90/D	79725	5"/6"	120V	15	4000	>90	1,250	50,000	Y	Y	Y





Smooth Eco

Item #	Order Code	Size	Voltage	Watts	CCT (Kelvin)	CRI	Lumens	Avg. Rated Life	ENERGY STAR	Dimmable	Damp Location
RTL/420WH/ECO/D	70940	4"	120V	10	2700	>90	600	35,000	Y	Y	Y
RTL/430WH/ECO/D	70941	4"	120V	10	3000	>90	620	35,000	Y	Y	Y
RTL/440WH/ECO/D	70942	4"	120V	10	4000	>90	645	35,000	Y	Y	Y
RTL/450WH/ECO/D	70643	4"	120V	10	5000	>90	670	35,000	Y	Y	Y
RTL/620WH/ECO/D	70687	5"/6"	120V	12	2700	>90	720	35,000	Y	Y	Y
RTL/630WH/ECO/D	70688	5"/6"	120V	12	3000	>90	740	35,000	Y	Y	Y
RTL/640WH/ECO/D	79347	5"/6"	120V	12	4000	>90	770	35,000	Y	Y	Y
RTL/650WH/ECO/D	79370	5"/6"	120V	12	5000	>90	800	35,000	Y	Y	Y



LED New Construction/ Remodel Housings

Topaz's new construction and remodel LED recessed housings are the perfect choice for LED trim kits. Offered in both 4" and 5/6" housing sizes, these line voltage housings are the perfect choice for new and remodel construction. The recessed housings are standard IC rated and Airtight to meet local building code requirements. The housings feature a quick connect for fast install of a wide array of Topaz LED trim kits.



Remodel

Item #	Order Code	Size	Description
RH4/RLED/IC/AT (shown)	79991	4"	IC/AT - Remodel
RH5/RLED/IC/AT	79997	5"	IC/AT - Remodel
RH6/RLED/IC/AT	79993	6"	IC/AT - Remodel

Optional GU24 Socket Adapter:

Item # RTLED/RETRO/GU24
Order Code: 79560



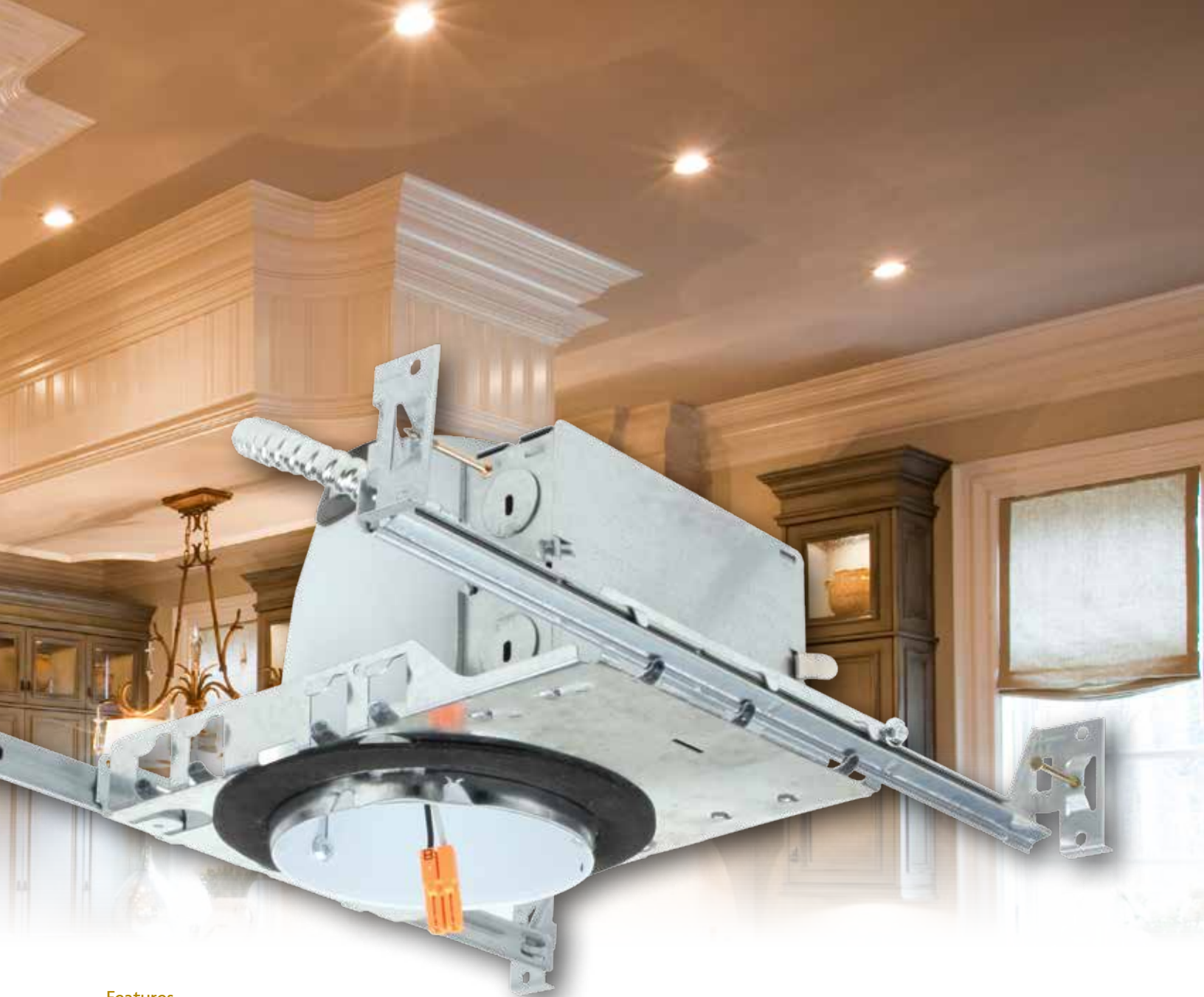

Features

- Steel housing construction
- IC Rated and Airtight to meet local building codes
- Quick connect for ease of connection to LED trim kits
- Available in new and remodel construction

New Construction

Item #	Order Code	Size	Description
RH4/NLED/IC/AT (shown)	79990	4"	IC/AT - New Construction
RH5/NLED/IC/AT	79996	5"	IC/AT - New Construction
RH6/NLED/IC/AT	79992	6"	IC/AT - New Construction

Optional GU24 Socket Adapter:
 Item # RTLED/RETRO/GU24
 Order Code: 79560





LED Outdoor Lighting

The Topaz line of outdoor LED fixtures feature attractive and contemporary designs with the latest advances in LED technology. Constructed of sturdy die-cast aluminum and finished with UV resistant powder coating, our fixtures deliver even more energy-savings compared to traditional lighting and reduce maintenance costs through long life.

With the Topaz speed-to-market, speed-to-innovation approach, our customers always benefit from the latest proven LED technologies at an unbeatable value.





Compact Flood Light

Topaz's small but powerful design for light commercial and residential applications. Highly efficient LED light engine in a compact housing unit fits the bill for smaller scale illumination such as façade, landscape, sign and instant-on security lighting. Enhanced precise optic control offers a superior light output that is glare-free. Easily installs to a standard J-box with 1/2" NPS swivel fitter for ground or wall mounting.

Our new UL Listed Compact Flood Light is engineered to maximize light output while offering a highly energy efficient operation. IP65 rated to withstand damaging weather conditions without performance interruption.



F-FLC-20WLED

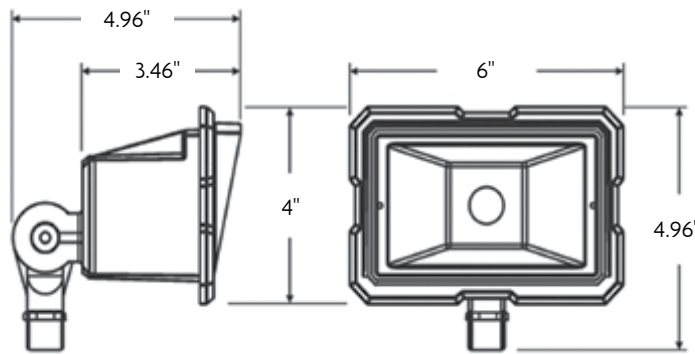

Features

- Advanced thermal management ensures a longer LED and driver lifespan
- Built to last, die-cast aluminum construction with UV stabilized, powder coat finish that withstands inclement weather conditions
- 50K hours operational life rating translates into 10 YEARS of maintenance free usage
- High quality lighting properties with less energy usage—superior LED, optical and thermal engineering provides >90 LPW and offers up to an 80% savings in energy use versus comparable HID luminaires or halogens
- Strong, tempered glass lens with integral glare shield produces glare-free, natural light
- PF >0.9 and THD <15%

Markets

- Commercial and residential

Applications

- General illumination of walkways, landscape lighting, building façades, security areas

Item #	Order Code	Input Voltage	Input Current Amps	Input Power Watts	Lumens	CCT (Kelvin)	CRI	IES Type Distribution	Equivalent Wattage*
F-FLC-20WLED	79795	120VAC	0.17	20	1,861	5000K	>70	II	200W Halogen/70W-100W MH

*Equivalent wattage dependent on fixture, reflectance and lumen maintenance of lamp



Low Profile Flood Lights

Topaz's low profile flood lights are perfect for landscape lighting and bright enough to illuminate building façades. These powerful flood lights deliver a wide angle NEMA 7Hx7V light distribution providing maximum light spread when lighting signs and washing walls or façades. Trunnion mounted flood makes it easy to replace wall mount applications for walkway illumination, or areas requiring security lighting. These fixtures are DLC qualified and are an economical option to replace standard HID floods saving up to 75% energy and providing up to 50,000 hours of life.





F-FL-13/50K/KN/BZ

F-FL-30/50K/KN/BZ



F-FL-50/50K/TR/BZ

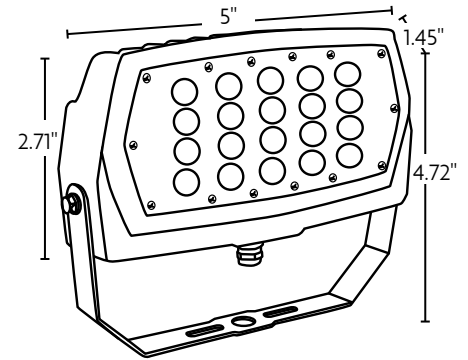
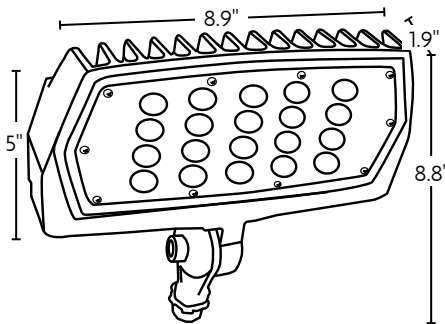
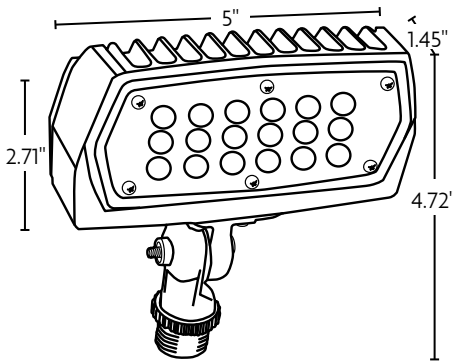

Features

- Built to last, die-cast aluminum construction with UV stabilized, powder coat finish that withstands inclement weather conditions
- Bronze finish
- Wide beam, NEMA 7Hx7V distribution
- Shock and impact resistant polycarbonate lens
- Perfect for applications requiring wide coverage
- Over 110 lumens per watt
- 1/2 NPS swivel mount or trunion mount

Applications

- Building façade, security, landscape, signs and display illumination
- Trunion mount for wall mount applications

(Available June 2017)

Item #	Input Order Code	Input Voltage	Input Current Amps	Power Watts	Lumens	CCT (Kelvin)	CRI	NEMA Type Distribution	Equivalent Wattage*	DLC
F-FL-13/50K/KN/BZ	74185	120-277V	0.40-0.17	13	1,474	5000K	80	7Hx7V	50-70W MH	Pending
F-FL-30/50K/KN/BZ	74183	120-277V	0.24-0.10	30	3,307	5000K	80	7Hx7V	70-150W MH	Pending
F-FL-50/50K/TR/BZ	74181	120-277V	0.10-0.04	50	5,562	5000K	80	7Hx7V	150-250W MH	Pending

*Equivalent wattage dependent on fixture, reflectance and lumen maintenance of lamp



Architectural Wall Pack/Flood Lights

Topaz's Architectural Wall Pack/Flood Light series combine style with high performance. With a housing design that optimizes the LED performance, these models offer an architecturally appealing look that also provides the best optic, thermal and LED design for enhanced performance versus traditional fixtures.

Our IP65 rated fixtures are designed for use in shopping malls, office complexes, hotels and parks where exceptional light output is required to ensure continuous ease of movement and safety at any hour, regardless of the forecast. With five different mounting options including trunion, large slip fit, knuckle mount and up and down wall mount, this high performing, versatile series can be effortlessly installed in almost any location.

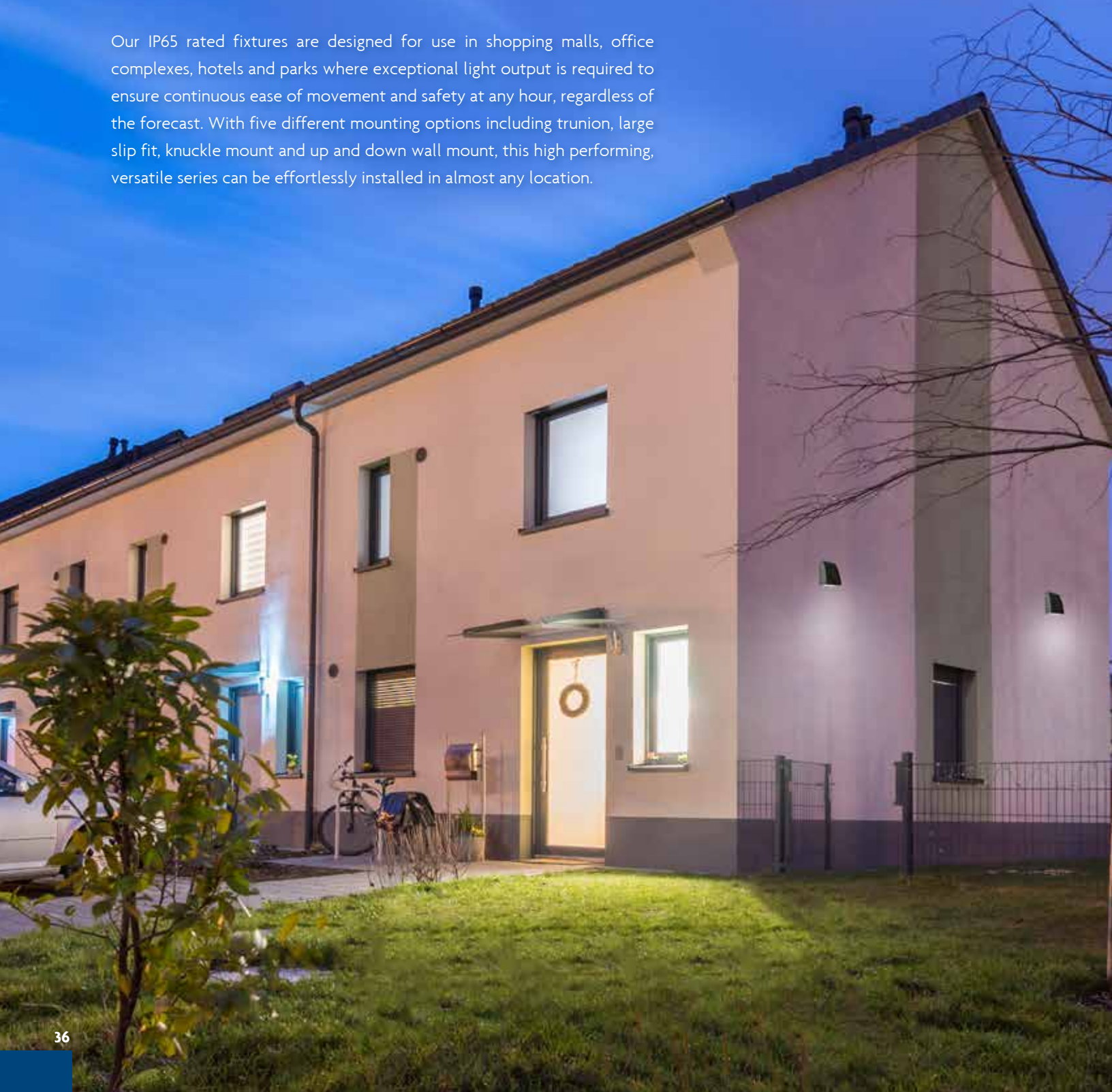

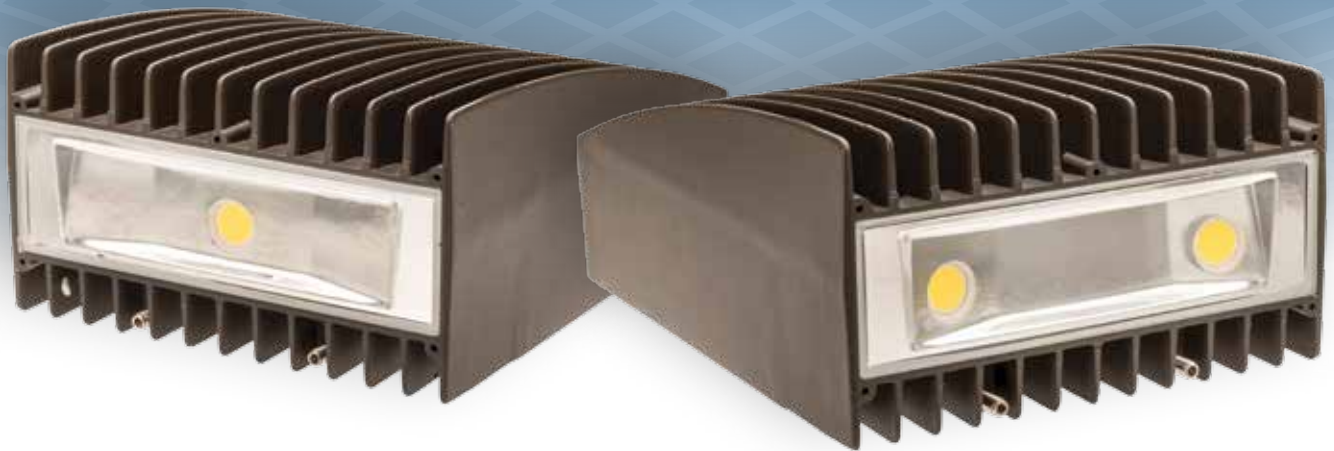

F-FL/WP-40WLED

F-FL/WP-60WLED



(Mounting brackets are sold separately)

Features

- Advanced thermal management ensures a longer LED and driver lifespan
- Built to last, die-cast aluminum construction with UV stabilized, powder coat finish that withstands inclement weather conditions
- 50K hours operational life rating translates into 10 YEARS of maintenance free usage
- High quality lighting properties with less energy usage—superior LED, optical and thermal engineering provides >100 LPW and offers up to an 80% savings in energy use versus comparable HID luminaires
- Strong, tempered glass lens with integral glare shield produces a focused throw forward, glare-free natural light
- Can be used with photocells for additional light control

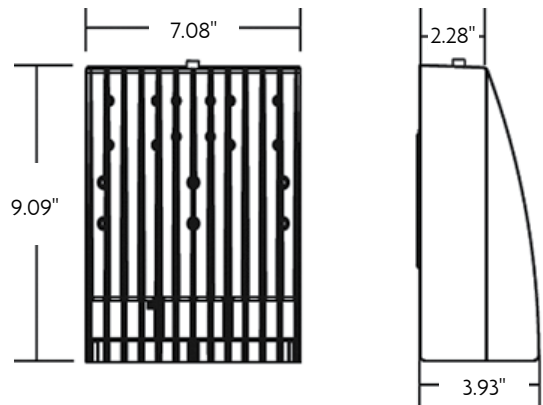

Markets

- Commercial and light industrial

Applications

- General illumination of walkways, areas of ingress, building façades, security areas

Item #	Order Code	Input Voltage	Input Current Amps	Input Power Watts	Lumens	CCT (Kelvin)	CRI	IES Type Distribution	Equivalent Wattage*	DLC
F-FL/WP-40WLED	79797	100-277V	0.36 - 0.15	40	4,211	5000K	>70	II	200W MH	Y
F-FL/WP-60WLED	79798	100-277V	0.54 - 0.22	60	6,659	5000K	>70	II	250W MH	Y
F-FL-KNMOUNT	70660									
F-FL-SFMOUNT	70662									
F-FL-TRMOUNT	70664									

*Equivalent wattage dependent on fixture, reflectance and lumen maintenance of lamp



Traditional Wall Packs

For general area lighting, Topaz's LED Wall Packs are a highly efficient solution. These lamps provide a long-lasting, cost-efficient option to high pressure sodium, metal halide and other traditional lights. Designed with a prismatic lens, these fixtures make the most of their highly efficient LEDs and create a widely distributed light to illuminate large areas. Constructed with a rugged, powder coated die-cast aluminum housing and featuring an operating expectancy of greater than 50,000 hours, these lights can last for years in all types of environments including warehouses, factories, restaurants, shopping areas and parks. The housing is designed to be mounted on junction boxes or direct wall mounts with feed-through conduit access for easy installation. An optional photocell can be installed for additional energy control.



F-WP-90LED/50K
F-WP-135LED/50K

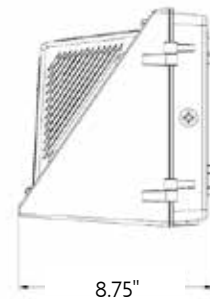
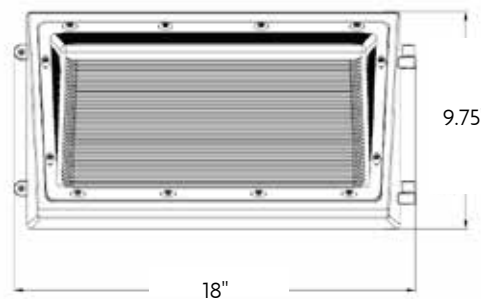



F-WPS-29WLED



F-WP-45LED/50K
F-WP-70LED/50K

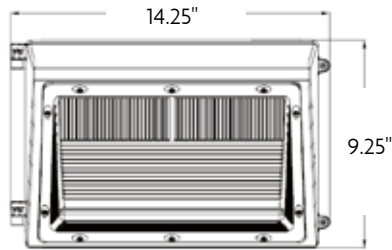
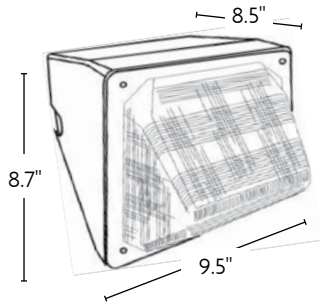

Features

- Die-cast housing with UV resistant powder coat finish
- High impact polycarbonate diffuser
- -40°C to 40°C ambient rating
- Universal voltage 100-277V
- THD: <20%; Power Factor: >0.9
- Life: >50K hours (L70)
- Photocell included with 45W, 70W, 90W and 135W wall pack



EMERGENCY LED DRIVER

(Sold separately)



WD-SP

(Sold separately)



F-WP-PHOTOCELL

(Sold separately)

Markets

- Outdoor commercial and residential

Can be used with 45W, 70W, 90W and 135W wall packs

Item #	Code	Input Voltage	Input Current Amps	Input Power Watts	Lumens	CCT (Kelvin)	CRI	IES Type Distribution	Equivalent Wattage*	DLC
F-WPS-29WLED	78790	100-277V	0.3 - 0.12	29	2,600	5000K	>70	IV	100W MH	-
F-WP-45LED/50K	74481	100-277V	0.17-0.38	45	5,300	5000K	>70	IV	175W MH	Y
F-WP-70LED/50K	74483	100-277V	0.26-0.59	70	8,100	5000K	>70	IV	250W MH	Y
F-WP-90LED/50K	74485	100-277V	0.34-0.75	90	11,200	5000K	>70	IV	320W MH	Y
F-WP-135LED/50K	74487	100-277V	0.50-1.13	135	16,400	5000K	>70	IV	400W MH	Y

BEL12/12-48V EL-1248-XXU Emergency LED Driver

WD-SP 79200 Surge Protector

F-WP-PHOTOCELL 72767 Photocell (120V)

*Equivalent wattage dependent on fixture, reflectance and lumen maintenance of lamp





Architectural Slim Wall Packs

Topaz's LED adjustable slim wall packs deliver full cutoff or semi cutoff light distribution. The innovative pivoting head design aims the light precisely and adjusts up to 20 degrees for forward throw illumination. Suitable for up to 25 foot mounting for applications including pathways, perimeter lighting and building entryways. Available in 30W, 40W (small), and 70W, 90W (large) with CCT of 5000K and DLC qualified.



F-AWP/30/50K/BZ
F-AWP/40/50K/BZ

F-AWP/70/50K/BZ
F-AWP/90/50K/BZ

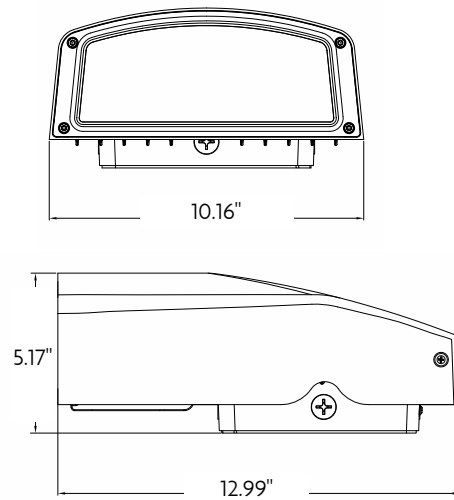
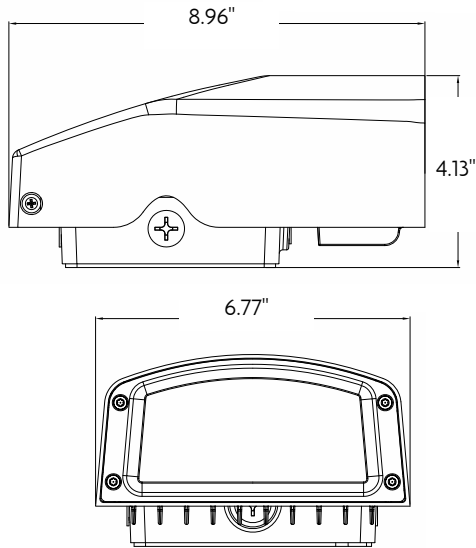

Features

- Adjustable head provides full cutoff and semi cutoff IES type III light distribution
- Light heads adjust up to 20 degrees for greater forward light distribution
- Built in 120-277VAC photocell
- Easy mounting system
- Life rating 50K hours (L70)

Applications

- Security, pathway and perimeter lighting, building entryways and walkways

Item #	Code	Input Voltage	Input Current Amps	Input Power Watts	Lumens	CCT (Kelvin)	CRI	IES Type Distribution	Equivalent Wattage*	DLC
F-AWP-30/50K/BZ	70743	100-277V	0.28-0.12	30	3,000	5000K	70	III	100W MH	Y
F-AWP-40/50K/BZ	70744	100-277V	0.37-0.16	40	4,500	5000K	70	III	175W MH	Y
F-AWP-70/50K/BZ	70745	100-277V	0.65-0.28	70	7,800	5000K	70	III	250W MH	Y
F-AWP-90/50K/BZ	70746	100-277V	0.83-0.36	90	10,500	5000K	70	III	320W MH	Y

*Equivalent wattage dependent on fixture, reflectance and lumen maintenance of lamp





Full Cutoff Wall Pack

Topaz's LED Full Cutoff Wall Pack is a highly efficient lighting solution that provides a long-lasting, energy-saving and cost-efficient alternative to high pressure sodium, metal halide and other traditional lights. The environmentally friendly, full cutoff wall mount design utilizes highly reliable, high power LEDs to minimize energy usage while maximizing directed light distribution, eliminating any upward illumination. Constructed with a rugged, powder coated die-cast aluminum housing and featuring an operating expectancy of greater than 50,000 hours, this fixture is sure to last for years and is suitable for outdoor applications including warehouses, factories, restaurants, shopping areas and parks. An optional photocell can be installed for additional energy control.



F-WPM-40WLED-FC

Features

- Die-cast housing with UV resistant powder coat finish
- Tempered glass lens
- -20°C to 50°C ambient rating
- Universal voltage 100-277V
- THD: <20%; Power Factor: >0.9
- Life: >50K hours (L70)
- Dark sky compliant

Markets

- Outdoor commercial and residential

Applications

- Warehouses
- Factories
- Loading docks

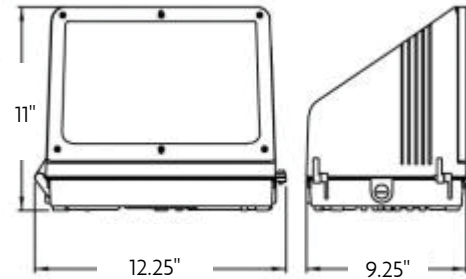

Item #	Order Code	Input Voltage	Input Current Amps	Input Power Watts	Lumens	CCT (Kelvin)	CRI	IES Type Distribution	Equivalent Wattage*	DLC
F-WPM-40WLED-FC	78804	100-277V	0.4 - 0.14	37	3,000	4700K	>70	VS	175W MH	Y

*Equivalent wattage dependent on fixture, reflectance and lumen maintenance of lamp



Small Wall Packs

Topaz's LED Small Wall Packs are a compact light source with a diffused prismatic lens providing uniform and efficient lighting. As an energy-saving and long life alternative to traditional light sources, they deliver incredible efficiency without sacrificing performance. Rated for greater than 50,000 hours of operation and constructed of rugged die-cast aluminum with a high impact polycarbonate lens, these wall packs are guaranteed to stand up to the harshest of elements for many years. Ideal for outdoor illumination of stairwells, pathways and entryways in commercial and residential settings.





F-WPS-17WLED



F-WPS-17WLED-WH

Features

- Die-cast housing with UV resistant powder coat finish
- High impact polycarbonate diffuser
- -20°C to 50°C ambient rating
- 120VAC, 50/60 Hz
- THD: <20%; Power Factor: >0.9
- Life: >50K hours (L70)
- Photocell included

Markets

- Outdoor commercial and residential

Applications

- Entryways
- Stairwells
- Hallways

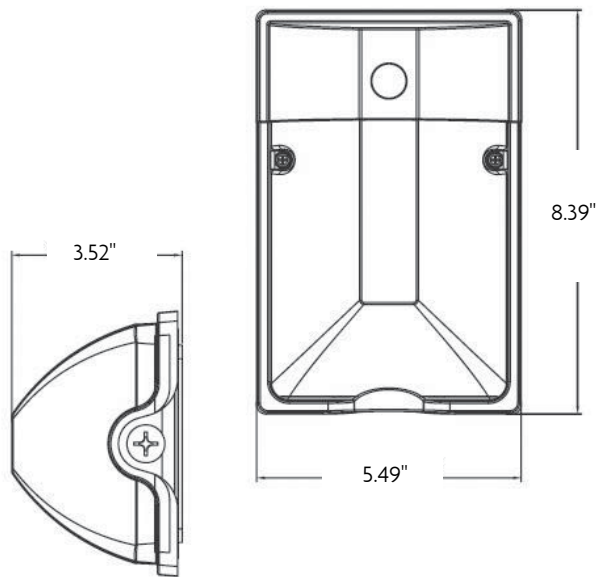

Item #	Order Code	Input Voltage	Input Current Amps	Input Power Watts	Lumens	CCT (Kelvin)	CRI	IES Type Distribution	Equivalent Wattage*	DLC
F-WPS-17WLED	73463	120VAC	0.20	17	1,700	5000K	>80	I	120W Incand., 50W MH	Y
F-WPS-17WLED-WH	73467	120VAC	0.20	17	1,700	5000K	>80	I	120W Incand., 50W MH	Y

*Equivalent wattage dependent on fixture, reflectance and lumen maintenance of lamp





Canopy and Parking Garage Lights

Our ruggedly designed LED Canopy and Parking Garage Lights promote safety and security in outdoor commercial and industrial environments while providing a long-lasting and energy-saving alternative to traditional HID lighting. These low profile fixtures feature a highly reliable LED light engine and an impact resistant polycarbonate optical diffuser. Suitable for outdoor or indoor applications, they are the perfect fit for garages, underground passage ways, corridors and fuel stations. Additionally, the low profile design offers an architectural appeal and is ideal for applications with limited space. With an expected operating life of greater than 50,000 hours and a 65% energy-savings compared to traditional HID lamps, these fixtures are sure to outlast the competition.



F-CNPY-45WLED-LP F-CNPY-70WLED-LP

Features

- Die-cast housing with UV resistant powder coat finish
- High impact polycarbonate diffuser
- Minimum starting temperature: -25°C
- Universal voltage 100-277V
- Quick mount installation
- THD: <20%; Power Factor: >0.9
- Life: >50K hours (L70)

Markets

- Outdoor and indoor commercial and hospitality

Applications

- Parking garages, stairwells, exterior canopy lighting.
Typically mounts up to 15'. Single gang, 3-1/2" octagonal, 4" square, 4" octagonal junction box

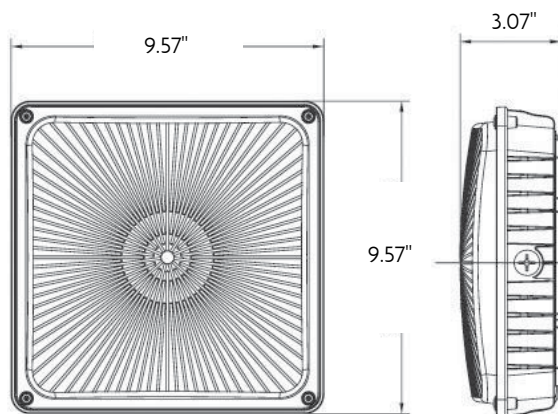

Item #	Order Code	Input Voltage	Input Current Amps	Input Power Watts	Lumens	CCT (Kelvin)	CRI	IES Type Distribution	Equivalent Wattage*	DLC
F-CNPY-45WLED-LP	73464	120-277V	0.52 - 0.2	45	4,050	5000K	>70	VS	175W MH	Y
F-CNPY-70WLED-LP	73465	120-277V	0.80 - 0.3	70	5,900	5000K	>70	VS	250W MH	Y

*Equivalent wattage dependent on fixture, reflectance and lumen maintenance of lamp



Round Canopy Lights

Our round canopies are the perfect alternative to the typical square. With a sleek appearance, frosted lens and powerful lumen output it's the best match to replace HID luminaires. DLC qualified and suitable for garages, perimeter lighting and entryways. Available in 40W and 60W and can be mounted up to 15 feet. The round canopy lights feature an easy mount system for connection to a junction box.

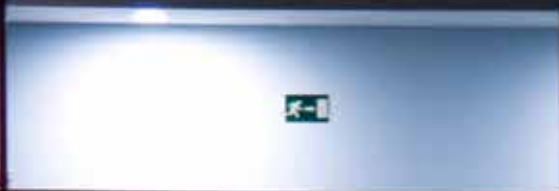



F-CNPY-RND40W/50K-BZ
F-CNPY-RND60W/50K-BZ



F-CNPY-RND40W/50K-WH
F-CNPY-RND60W/50K-WH

Features

- Die-cast housing with impact resistant polycarbonate lens
- Low profile suitable for parking garage, exterior canopies, commercial applications
- Pendant mount or surface mount to J Box
- -40°C to 45C ambient temp
- Universal voltage 100-277V/60Hz
- IES Distribution Type V
- Life: >50K hours (L70)

Applications

- Parking garages, stairwells, exterior canopy lighting.
 Typically mounts up to 15'. Single gang, 3-1/2" octagonal, 4" square, 4" octagonal junction box

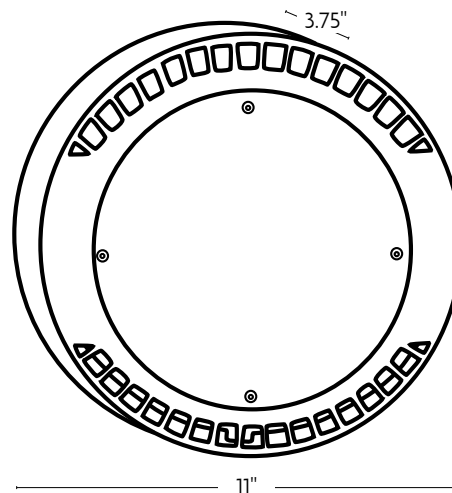

Item #	Order Code	Input Voltage	Input Current Amps	Input Power Watts	Lumens	CCT (Kelvin)	CRI	Equivalent Wattage*	DLC
F-CNPY-RND40W/50K-BZ	70763	120-277V	0.33-0.15	40	3,845	5000K	70	175W MH	Y
F-CNPY-RND40W/50K-WH	70761	120-277V	0.33-0.15	40	3,845	5000K	70	175W MH	Y
F-CNPY-RND60W/50K-BZ	70767	120-277V	0.5-0.22	60	5,770	5000K	70	250W MH	Y
F-CNPY-RND60W/50K-WH	70765	120-277V	0.5-0.22	60	5,770	5000K	70	250W MH	Y

*Equivalent wattage dependent on fixture, reflectance and lumen maintenance of lamp



Dusk-to-Dawn

Utilizing a single source LED, Topaz's Dusk-to-Dawn fixture with its NEMA approved photocell provides prismatic designed light output for any environment. A long-lasting alternative to traditional lights with a life rating of greater than 50,000 hours, this fixture features chip on board (COB) LED technology and advanced thermal management and offers energy-savings of up to 80% compared to typical fixtures. Fabricated with a heavy duty, corrosion resistant cast aluminum housing and designed to be installed on a wall or pole, this fixture is ideal for parking lots, warehouses, farm applications and factory loading docks.





F-D2D-45WLED KIT F-D2D-70WLED KIT

(Also available in gray)

Features

- Die-cast housing with UV resistant powder coat finish
- Highly efficient LED light source up to 110 lumens/watt
- Minimum starting temperature: -25°C
- Full cutoff optical design
- THD: <20%; Power Factor: >0.9
- Life: >50K hours, up to 3X longer than traditional HID sources
- 120-227V photocell included
- Mounting pole and hardware included

Markets

- Outdoor commercial and residential

Applications

- Barn lighting
- Area lighting
- Loading docks
- Parking lots

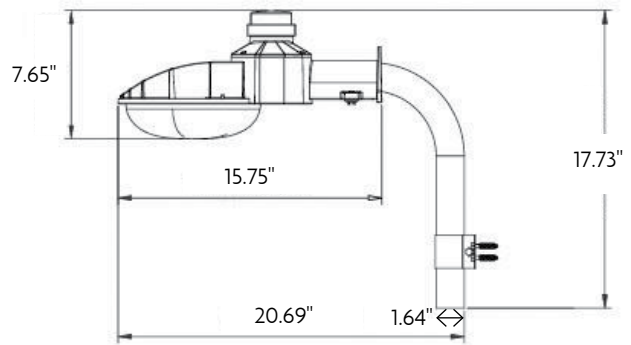

Item #	Order Code	Input Voltage	Input Current Amps	Input Power Watts	Lumens	CCT (Kelvin)	CRI	IES Type Distribution	Equivalent Wattage*	DLC
F-D2D-45WLED KIT	73461	120-277V	0.52 - 0.2	45	5,000	5000K	>70	VS	175W MH	Y
F-D2D-70WLED KIT	73462	120-277V	0.80 - 0.3	70	7,000	5000K	>70	VS	250W MH	Y
F-D2D-70WLED KIT (GRAY)	73470	120-277V	0.80 - 0.3	70	7,000	5000K	>70	VS	250W MH	Y

*Equivalent wattage dependent on fixture, reflectance and lumen maintenance of lamp



Parking Lot/Area Lights

Topaz's Area Lights feature outstanding photometric performance, uniform illumination, low-profile design, high efficacy, long lifespan, and easy installation. The one-piece die-cast aluminum housing with UV resistant powder coat finish offers outstanding corrosion protection. Ideal for use in various commercial environments such as auto dealerships, parking lots, walkways, roadways, campuses, façade lighting, grocery stores and other public areas.





F-ARL/150W/50K/SF



F-ARL/150W/50K/TR



F-ARL/300W/50K/SF

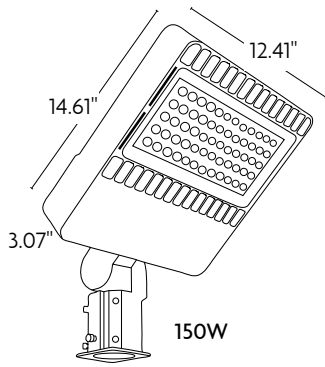

150W

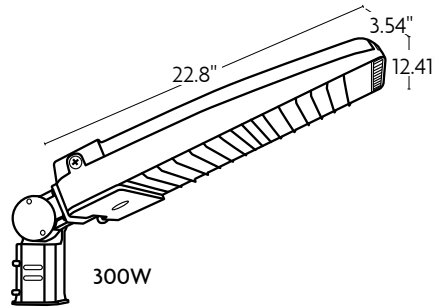

300W



F-ARL/300W/50K/TR

Features

- One piece die-cast aluminum housing with UV resistant polycarbonate optical lens
- 2" slipfitter mounting or trunion mount options
- 130 Lumens per watt (LPW)
- Suitable for mounting heights ranging from 18-36' in area lighting applications
- Silicone rubber included to create a weatherproof seal
- Twist-lock photocell included
- Ambient temperature range: -40°F to 113°F

Applications

- Parking lots, area lighting, illumination of areas of ingress, security lighting



F-FL/PL-ADPT-90DEG



F-FL/PL-POLE MOUNT



F-FL/PL-ADPT-SQ-RND

Item #	Order Code	Input Voltage	Input Current Amps	Input Watts	Lumens	CCT (Kelvin)	CRI	Avg. Rated Life	Equivalent Wattage*	DLC
F-ARL/150W/50K/SF	74470	120-277V	1.39-0.60	150	20,000	5000K	>70	50,000	400W MH	Y
F-ARL/300W/50K/SF	74471	120-277V	2.78-1.20	300	39,000	5000K	>70	50,000	1,000W MH	Y
F-ARL/150W/50K/TR	74474	120-277V	1.39-0.60	150	21,000	5000K	>70	50,000	400W MH	Y
F-ARL/300W/50K/TR	74475	120-277V	2.78-1.20	300	40,000	5000K	>70	50,000	1,000W MH	Y
F-FL/PL-ADPT-90DEG	73380	90° Adapter								
F-FL/PL-ADPT-SQ-RND	73382	4" Square to Round Pole Adapter								
F-FL/PL-POLE MOUNT	74220	4" Pole mounting kit for square or round pole								

*Equivalent wattage dependent on fixture, reflectance and lumen maintenance of lamp





Line Voltage Recessed Downlighting

Topaz's residential/commercial line voltage housings and trims are the perfect choice for new and remodel construction. Available in 4", 5" and 6" diameter openings to accommodate a wide array of trims to complement any style. Offered in both IC and Non-IC rated fixtures to meet local building code requirements. For applications with restricted space, Topaz carries a line of shallow housings as well as housings for sloped ceilings.



4" Line Voltage New Construction Housing

Features

- 50 watt max PAR/R20
- Plaster frame: Galvanized steel construction. Housing can be removed from plaster frame to provide access to the junction box
- Thermal protector: Self resetting thermal protector deactivates fixture if overheating occurs due to improper lamping or misapplied insulation
- UL Listed for damp location
- UL Listed for feed through wiring
- Certified under ASTM-E283 for airtight construction (RH4/N/IC/AT only)

Installation

- Bar hanger: Pre-installed nails easily install in regular or engineered lumber. Bar hangers are adjustable from 13-5/8" to 25" and can be repositioned 90 degree on plaster frame
- Junction box: Listed for through branch circuit wiring. Contains seven 7/8" knockouts and four Romex pryouts with strain relief



Non-IC

Item #: RH4/N

Order Code: 78080



IC Airtight

Item #: RH4/N/IC/AT

Order Code: 79437

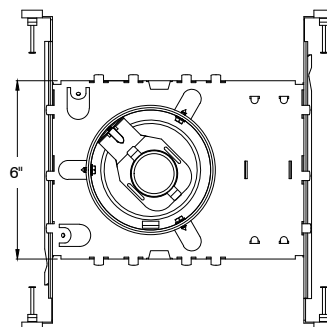
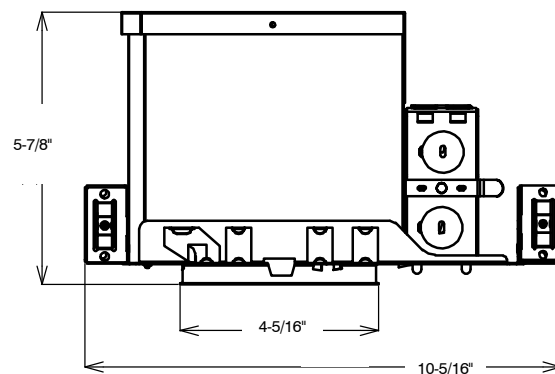
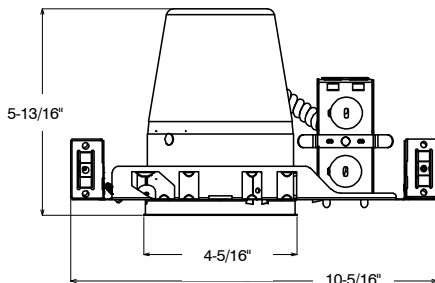
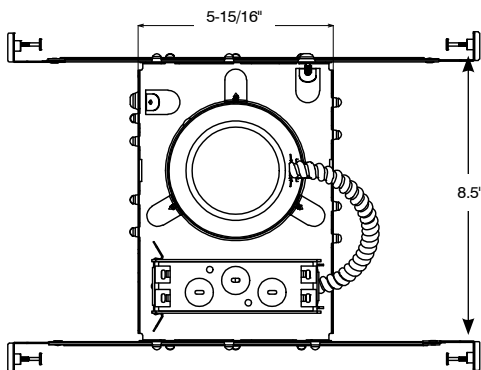

4" Line Voltage Remodel Construction Housing

Features

- 50 watt max PAR/R20
- Thermal protector: Self resetting thermal protector deactivates fixture if overheating occurs due to improper lamping or misapplied insulation
- Remodel clips: Four remodel clips secure housing and accommodates 1/2" and 5/8" ceiling materials
- UL Listed for damp location
- UL Listed for feed through wiring
- Certified under ASTM-E283 for airtight construction

Installation

- Junction box: Listed for through branch circuit wiring. Contains seven 7/8" knockouts and four Romex pryouts with strain relief



Non-IC Airtight

Item #: RH4/R/AT

Order Code: 78280

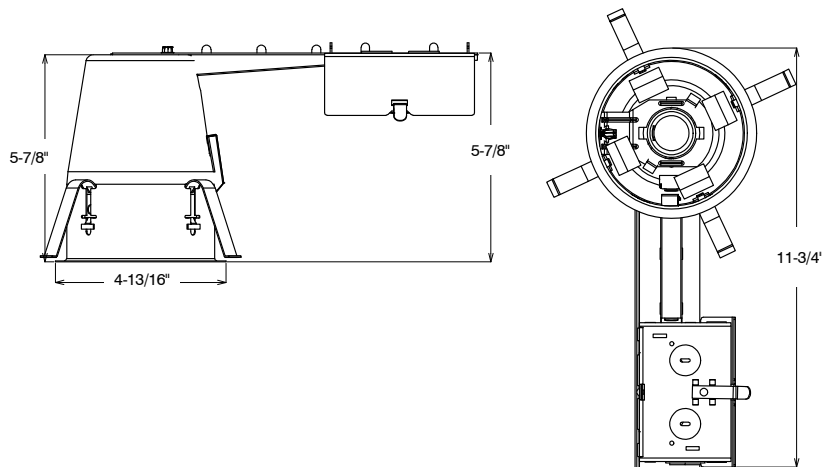

4" Line Voltage Trims



RT400CL/WH
 Clear Reflector with White Ring
 Uses 50W R20, PAR20 Lamps
 Order Code: 77671

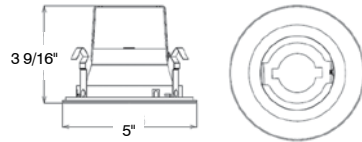

RT401BL/PB
 Black Reflector with Polished Brass Ring
 Uses 50W R20, PAR20 Lamps
 Order Code: 78732

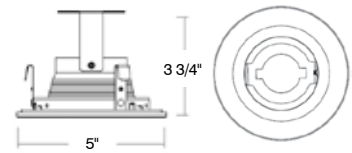

RT400WH
 White Reflector with White Ring
 Uses 50W R20, PAR20 Lamps
 Order Code: 79555

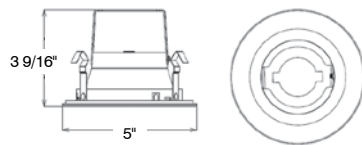

RT401BL/BAFF
 Black Metal Baffle (Only)
 Uses 50W R20, PAR20 Lamps
 Order Code: 78738

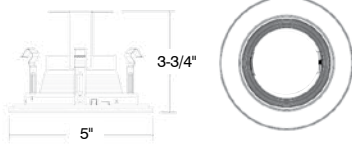

RT401BL
 Black Baffle with Black Ring
 Uses 50W R20, PAR20 Lamps
 Order Code: 79170

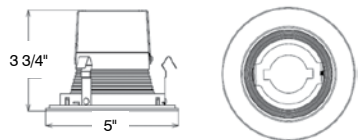

RT401BL/WH
 Black Baffle with White Ring
 Uses 50W R20, PAR20 Lamps
 Order Code: 70052

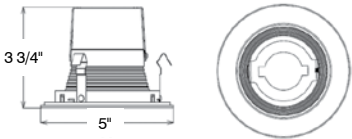

RT401BL/CH
 Black Reflector with Chrome Ring
 Uses 50W R20, PAR20 Lamps
 Order Code: 78733

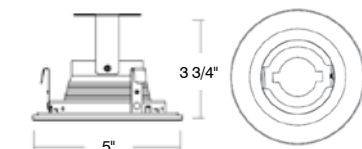

RT401WH
 White Baffle with White Ring
 Uses 50W R20, PAR20 Lamps
 Order Code: 79129

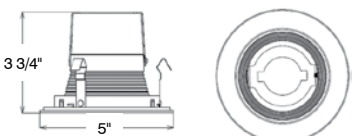

4" Line Voltage Trims



RT403BL
Black Eyeball
Uses 50W R20, PAR20 Lamps
Order Code: 78094

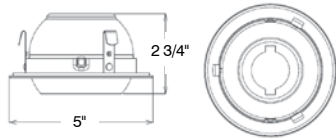

RT409WH/A
Albalite Lens White Shower Trim
Uses 50W R20, PAR20 Lamps
Order Code: 77605

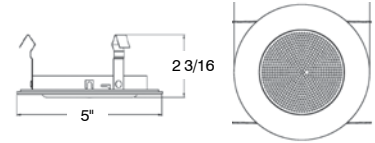

RT403WH
White Eyeball
Uses 50W R20, PAR20 Lamps
Order Code: 77606

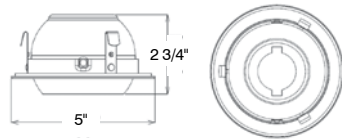

RT409WH/FL
Fresnel Glass White Shower Trim
Uses 50W R20, PAR20 Lamps
Order Code: 77672

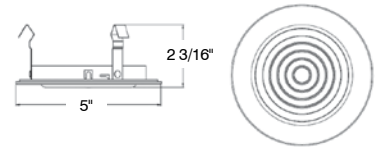

RT406BL
Open Black Gimbal with Black Ring
Uses 50W R20, PAR20 Lamps
Order Code: 79190

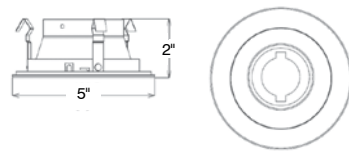

RT421WH
White Baffle with White Wall Wash
Uses 50W R20, PAR20 Lamps
Order Code: 77607

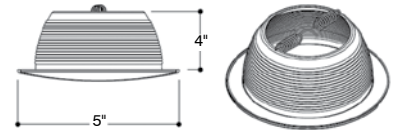

RT406WH
Open White Gimbal with White Ring
Uses 50W R20, PAR20 Lamps
Order Code: 78342

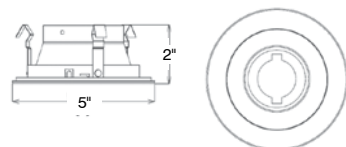

RT429WH
4" White Square Cover with
White Round Gimbal
Uses 50W R20, PAR20 Lamps
Order Code: 77608

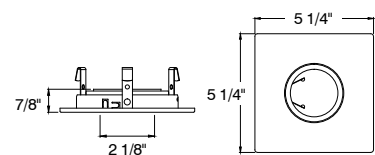

5" Line Voltage New Construction Housing

Features

- 75 watt PAR/BR30
- Plaster frame: Galvanized steel construction. The housing can be removed from plaster frame to provide access to the junction box.
- Thermal protector: Self resetting thermal protector deactivates fixture if overheating occurs due to improper lamping or misapplied insulation
- UL Listed for damp location
- UL Listed for feed through wiring
- Certified under ASTM-E283 for airtight construction

Installation

- Bar hanger: Pre-installed nails easily install in regular or engineered lumber. Bar hangers are adjustable from 13-5/8" to 25" and can be repositioned 90 degree on plaster frame
- Junction box: Listed for through branch circuit wiring. Contains seven 7/8" knockouts and four Romex pryouts with strain relief



IC Airtight

Item #: RH5/N/IC/AT

Order Code: 77604

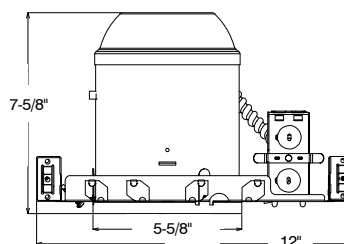
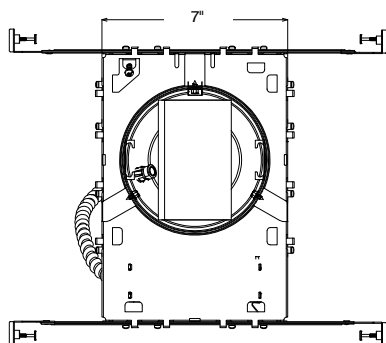

5" Line Voltage Remodel Construction Housing

Features

- 75 watt PAR/BR30
- Thermal protector: Self resetting thermal protector deactivates fixture if overheating occurs due to improper lamping or misapplied insulation
- Remodel clips: Four remodel clips secure housing and accommodates 1/2" and 5/8" ceiling materials
- UL Listed for damp location
- UL Listed for feed through wiring
- Certified under ASTM-E283 for airtight construction

Installation

- Junction box: Listed for through branch circuit wiring. Contains seven 7/8" knockouts and four Romex pryouts with strain relief



IC Airtight

Item #: RH5/R/IC/AT

Order Code: 77603

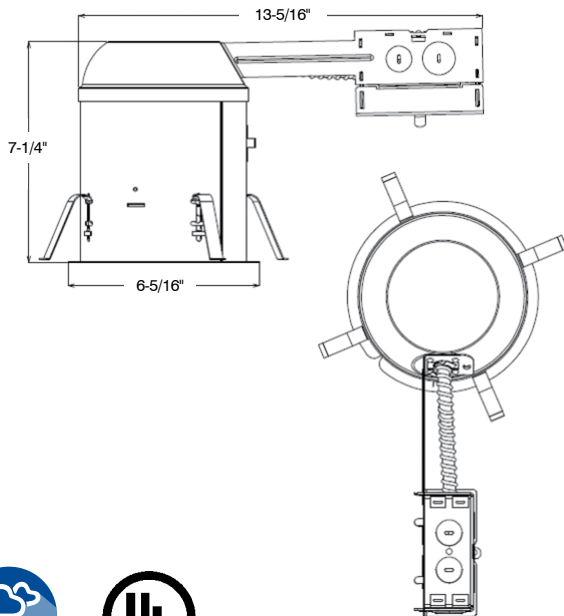

5" Line Voltage Trims



RT500CL/WH

Deep Clear Reflector with White Ring
Uses 75W Max BR30, PAR30 Lamps
Order Code: 79163

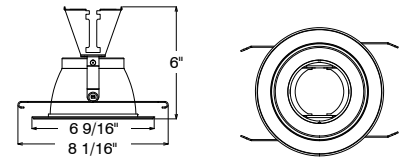

RT501WH

White Shallow Baffle Trim
Uses 75W Max BR30, PAR30 Lamps
Order Code: 77601

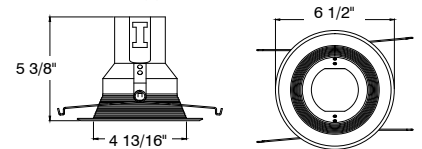

RT502WH

White Step Baffle with White Ring
Uses 75W Max BR30, PAR30 Lamps
Order Code: 79164

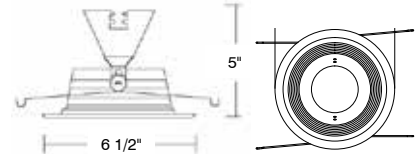

RT509WH/A

Albalite Glass Lens with White Ring
Uses 40W A19, 50W PAR20 Lamps
Order Code: 79410

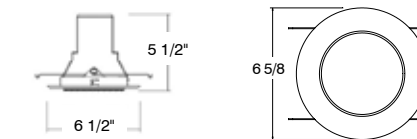

RT509WH/FL

Fresnel Shower Trim with White Ring
Uses 40W A19, 50W PAR20 Lamps
Order Code: 77602

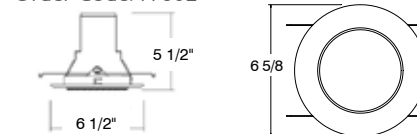

6" Line Voltage New Construction Housing

Features

- 75 watt max
- Plaster frame: Galvanized steel construction. Housing can be removed from plaster frame to provide access to the junction box.
- Thermal protector: Self resetting thermal protector deactivates fixture if overheating occurs due to improper lamping or misapplied insulation
- UL Listed for damp location
- UL Listed for feed through wiring
- Certified under ASTM-E283 for airtight construction

Installation

- Bar hanger: Pre-installed nails easily install in regular or engineered lumber. Bar hangers are adjustable from 13-5/8" to 25" and can be repositioned 90 degree on plaster frame
- Junction box: Listed for through branch circuit wiring. Contains seven 7/8" knockouts and four Romex pryouts with strain relief



IC Airtight

Item #: RH6/N/IC/ATS

Order Code: 78516



IC/AT Airtight with Floating Socket

Item #: RH6/N/IC/ATS/FL

Order Code: 77841

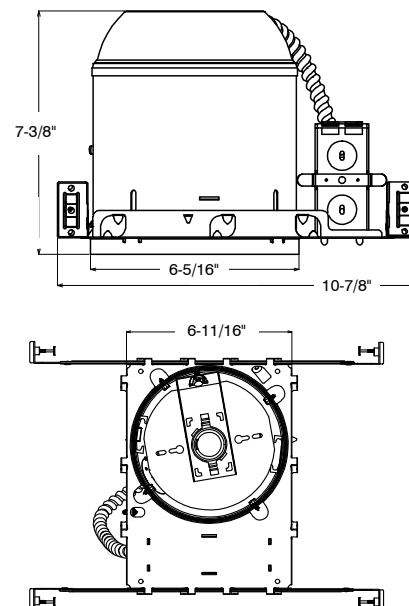
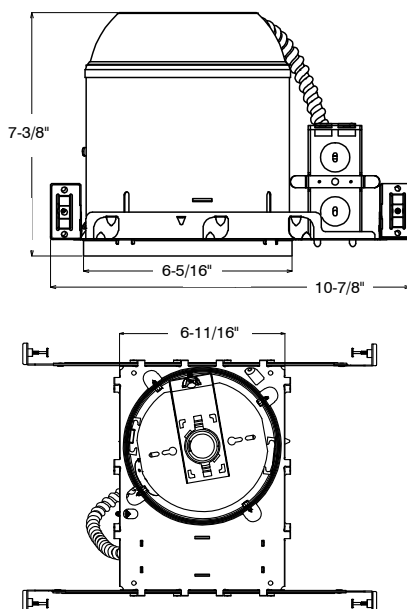

6" Line Voltage New Construction Housing

Features

- 75 watt max
- Plaster frame: Galvanized steel construction. Housing can be removed from plaster frame to provide access to the junction box
- Thermal protector: Self resetting thermal protector deactivates fixture if overheating occurs due to improper lamping or misapplied insulation
- UL Listed for damp location
- UL Listed for feed through wiring

Installation

- Bar hanger: Pre-installed nails easily install in regular or engineered lumber. Bar hangers are adjustable from 13-5/8" to 25" and can be repositioned 90 degree on plaster frame
- Junction box: Listed for through branch circuit wiring. Contains seven 7/8" knockouts and four Romex pryouts with strain relief
- Housing: Galvanized steel construction



IC Steel

Item #: RH6/N/ICS

Order Code: 78521

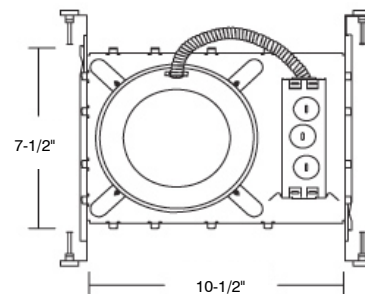
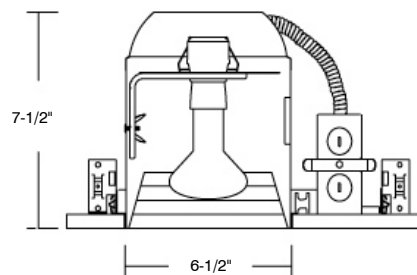

6" Line Voltage New Construction Housing

Features

- 75 watt max
- Plaster frame: Galvanized steel construction. Housing can be removed from plaster frame to provide access to the junction box.
- Thermal protector: Self resetting thermal protector deactivates fixture if overheating occurs due to improper lamping or misapplied insulation
- UL Listed for damp location
- UL Listed for feed through wiring
- Certified under ASTM-E283 for airtight construction (RH6/N/IC/AT only)

Installation

- Bar hanger: Pre-installed nails easily install in regular or engineered lumber. Bar hangers are adjustable from 13-5/8" to 25" and can be repositioned 90 degree on plaster frame
- Junction box: Listed for through branch circuit wiring. Contains seven 7/8" knockouts and four Romex pryouts with strain relief

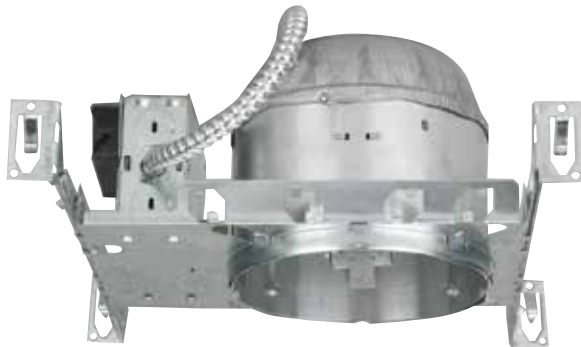

Shallow IC

Item #: RH6/N/S/IC

Order Code: 77664



Shallow IC Airtight

Item #: RH6/N/S/IC/AT

Order Code: 78532

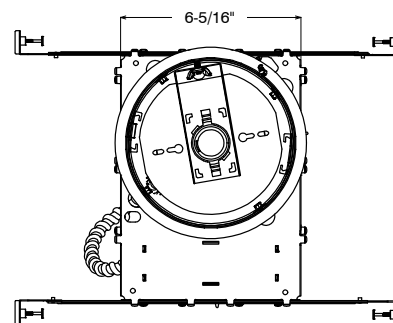
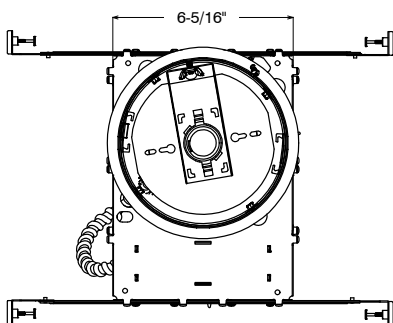
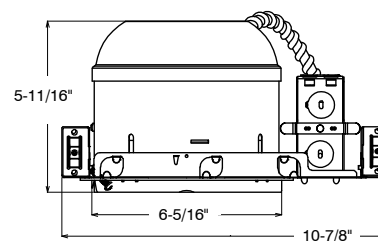
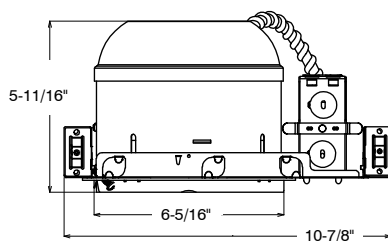

6" Line Voltage Remodel Construction Housing

Features

- 75 watt max
- Remodel clips: Four remodel clips secure housing and accommodates 1/2" and 5/8" ceiling materials
- Thermal protector: Self resetting thermal protector deactivates fixture if overheating occurs due to improper lamping or misapplied insulation
- UL Listed for damp location
- UL Listed for feed through wiring
- Certified under ASTM-E283 for airtight construction (RH6/R/IC/AT only)

Installation

- Junction box: Listed for through branch circuit wiring. Contains six 7/8", one 1-1/8" knockouts and four Romex pryouts with strain relief



IC

Item #: RH6/R/IC

Order Code: 77661



IC Airtight

Item #: RH6/R/IC/AT

Order Code: 79415

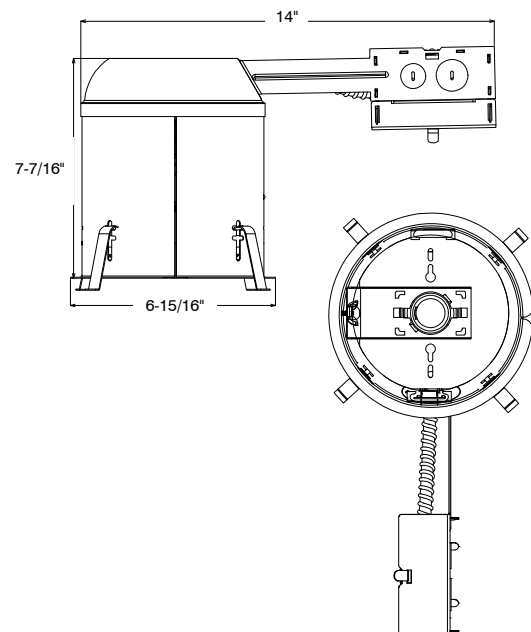
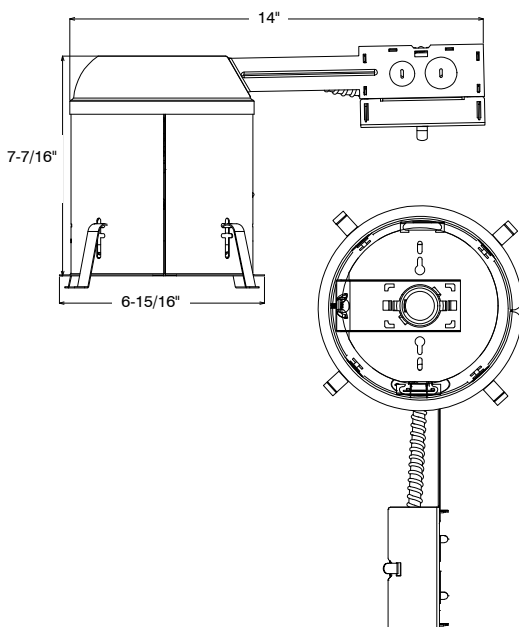

6" Line Voltage Remodel Construction Housing

Features

- 75 watt max
- Remodel clips: Four remodel clips secure housing and accommodates 1/2" and 5/8" ceiling materials
- Thermal protector: Self resetting thermal protector deactivates fixture if overheating occurs due to improper lamping or misapplied insulation
- UL Listed for damp location
- UL Listed for feed through wiring

Installation

- Junction box: Listed for through branch circuit wiring. Contains six 7/8", one 1-1/8" knockouts and four Romex pryouts with strain relief



Shallow Non-IC

Item #: RH6/R/S

Order Code: 77665

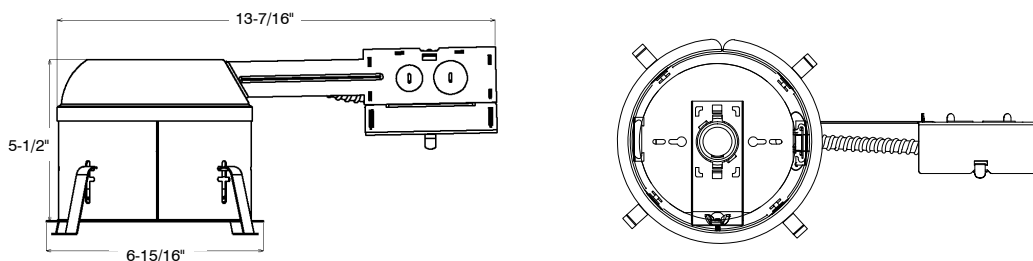

6" Line Voltage Remodel Construction Housing

Features

- 75 watt max
- Remodel clips: Four remodel clips secure housing and accommodates 1/2" and 5/8" ceiling materials
- Thermal protector: Self resetting thermal protector deactivates fixture if overheating occurs due to improper lamping or misapplied insulation
- UL Listed for damp location
- UL Listed for feed through wiring
- Certified under ASTM-E283 for airtight construction (RH6/R/S/IC/AT only)

Installation

- Junction box: Listed for through branch circuit wiring. Contains six 7/8", one 1-1/8" knockouts and four Romex pryouts with strain relief



Shallow IC

Item #: RH6/R/S/IC

Order Code: 77662



Shallow IC Airtight

Item #: RH6/R/S/IC/AT

Order Code: 78534

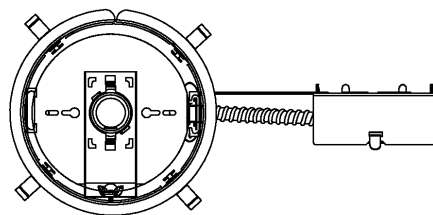
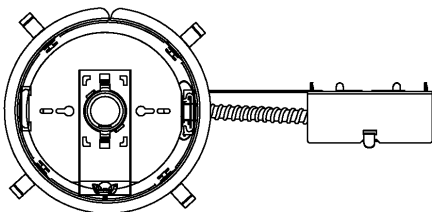
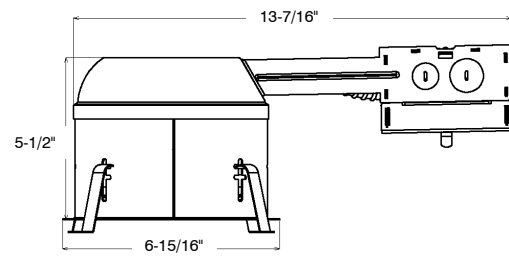
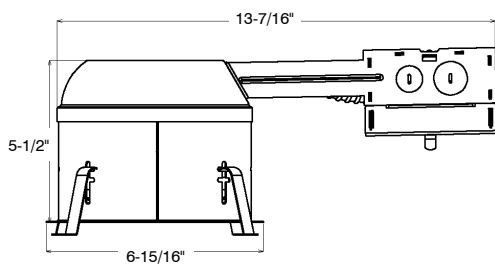

6" Line Voltage Trims



RT600CL/CH/R30
Clear Reflector with Chrome Ring
Uses BR/PAR30 Lamps
Order Code: 71902

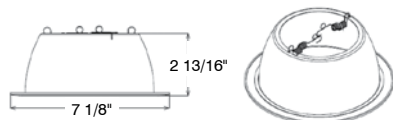

RT601BL
Black Step Baffle with Black Ring
Uses BR/PAR30 Lamps
Order Code: 79604

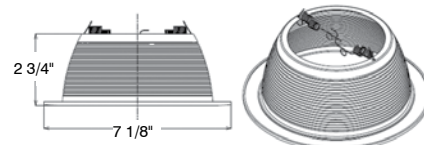

RT600CL/WH/R30
Clear Reflector with White Ring
Uses BR/PAR30 Lamps
Order Code: 77703

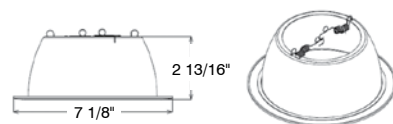

RT601BL/WH
Black Step Baffle with White Ring
Uses BR/PAR30 Lamps
Order Code: 77102

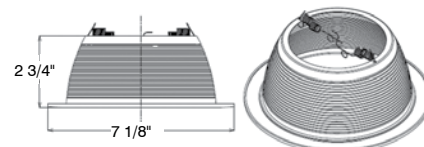

RT600CL/WH/R40
Clear Reflector with White Ring
Uses R40/PAR38 Lamps
Order Code: 78366

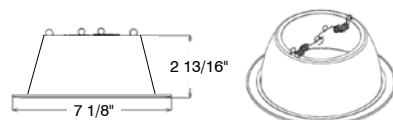

RT601SCH
All Satin Chrome Step Baffle
Uses BR/PAR30 Lamps
Order Code: 70960

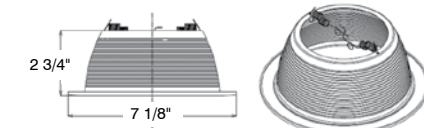

RT600GO/WH/R30
Gold Reflector with White Ring
Uses BR/PAR30 Lamps
Order Code: 79552

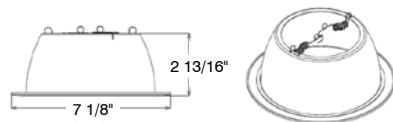

RT601WH
White Step Baffle with White Ring
Uses BR/PAR30 Lamps
Order Code: 79135

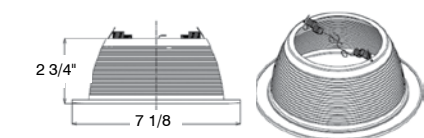

RT600WH/R30
White Reflector with White Ring
Uses BR/PAR30 Lamps
Order Code: 79162



RT602BL
Black Step Baffle with Black Ring
Uses R40/PAR38 Lamps
Order Code: 78102

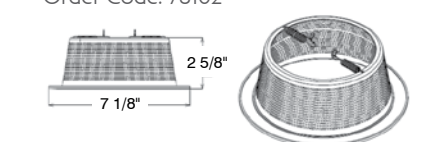

6" Line Voltage Trims



RT602BL/WH

Black Step Baffle with White Ring
Uses R40/PAR38 Lamps
Order Code: 79179

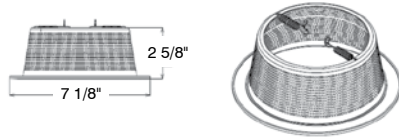

RT602WH

White Step Baffle with White Ring
Uses R40, PAR38 Lamps
Order Code: 77673

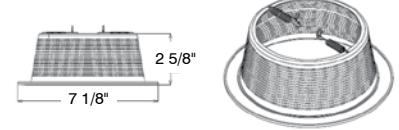

RT602BL/WH/AT

Socket Supporting Black Step Baffle with White Ring, Airtight, Torsion Springs, for Floating Medium Base Socket
Uses BR/PAR30 Lamps
Order Code: 79610

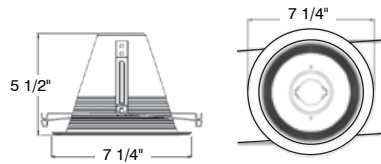

RT602WH/AT

Socket Supporting Matte White Step Baffle with White Ring, Airtight, Torsion Springs, for Floating Medium Base Socket
Uses BR/PAR30 Lamps
Order Code: 77598

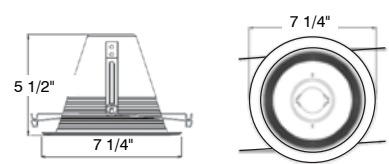

RT602GW/AT

Socket Supporting Gloss White Step Baffle with White Ring, Airtight, Torsion Springs, for Floating Medium Base Socket
Uses BR/PAR30 Lamps
Order Code: 77565

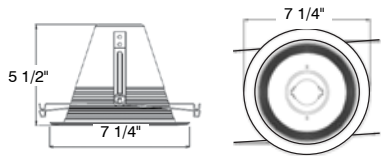

RT603BL

Black Eyeball
Uses BR/PAR30 Lamps
Order Code: 79573

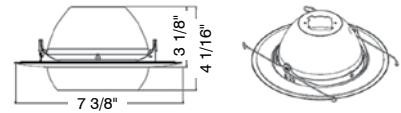

RT602GW/AT/FS

Socket Supporting Gloss White Step Baffle with White Ring, Airtight, Friction Springs, for Floating Medium Base Socket
Uses BR/PAR30 Lamps
Order Code: 77564

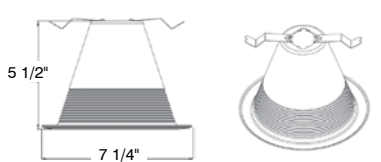

RT603WH

White Eyeball
Uses BR/PAR30 Lamps
Order Code: 79551

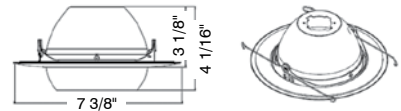

RT602SCH

Satin Chrome Step Baffle with Satin Chrome Ring
Uses R40, PAR38 Lamps
Order Code: 78103

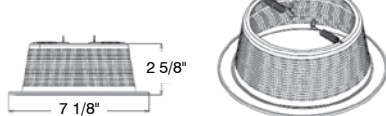

RT604SCH

Open Satin Chrome Trim
Uses BR/PAR30 Lamps
Order Code: 78107



6" Line Voltage Trims



RT604WH
Open White Trim
Uses BR/PAR30 Lamps
Order Code: 78762



RT609WH/FL/P
Fresnel Glass Lens with White Plastic Ring Shower Trim
Uses 40W A19 Lamps
Order Code: 79160



RT605WH
Open White Ring
Uses R40/PAR38 Lamps
Order Code: 70959



RT609WH/FR/P
Frosted Glass Lens with White Plastic Ring Shower Trim
Uses 40W A19 Lamps
Order Code: 79160

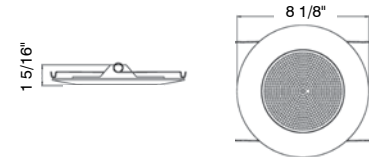

RT609WH/A
Albalite Lens Shower Trim with Metal Ring
Uses 40W A19 Lamps
Order Code: 79136

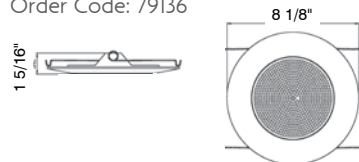

RT610CL/WH
Clear Deep Reflector with White Ring
Uses 60W A19 Lamps
Order Code: 79156

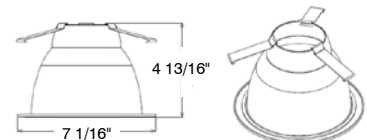

RT609WH/A/P
Albalite Lens Shower Trim with Plastic Ring
Uses 40W A19 Lamps
Order Code: 79137

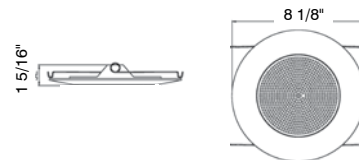

RT611WH
Clear Deep Reflector with White Step Baffle and White Ring
Uses 60W A19
Order Code: 79158

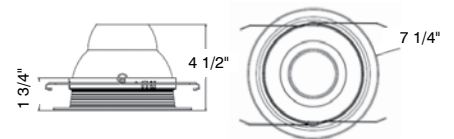

RT609WH/FL
Fresnel Glass Lens with White Metal Ring Shower Trim
Uses 40W A19 Lamps
Order Code: 77559



RT612WH
White Step Baffle with White Ring
Uses BR/PAR30 Lamps
Order Code: 79159

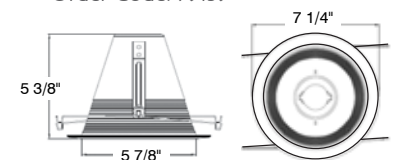



RT613WH/R

White Baffle with White Regressed Eyeball
 Uses BR/PAR30 Lamps
 Order Code: 77599

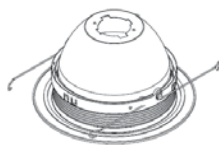
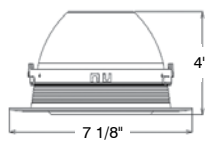

RT614GW

Gloss White Deep Smooth Cone
 Uses BR/PAR30 Lamps
 Order Code: 79850

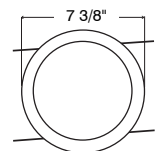
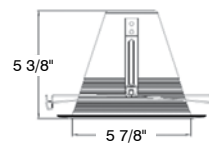

6" Line Voltage New Construction Housing for Sloped Ceilings

Features

- 75 watt max
- Housing: Designed for use in ceiling with slopes from 2/12 to 6/12
- Socket: The socket aiming mechanism allows the lamp to be aimed straight down regardless of ceiling pitch
- Thermal protector: Self resetting thermal protector deactivates fixture if overheating occurs due to improper lamping or misapplied insulation
- UL Listed for damp location
- UL Listed for feed through wiring
- Certified under ASTM-E283 for airtight construction

Installation

- Bar hanger: Pre-installed nails easily install in regular or engineered lumber. Bar hangers are adjustable from 13-5/8" to 25" and can be repositioned 90 degree on plaster frame
- Junction box: Listed for through branch circuit wiring. Contains seven 7/8" knockouts and four Romex pryouts with strain relief



IC Airtight

Item #: RH6/NSL/IC/AT

Order Code: 78515

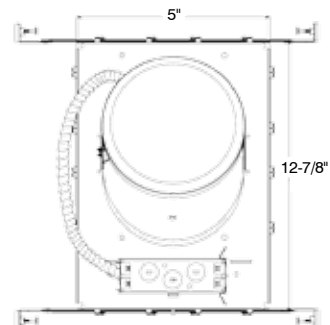
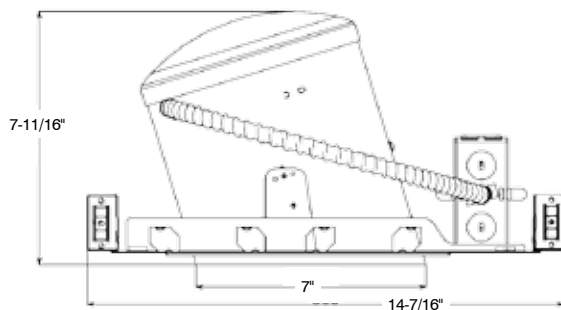

6" Line Voltage New Construction Housing for Sloped Ceilings

Features

- 150 watt max
- Housing: Designed for use in ceiling with slopes from 2/12 to 6/12
- Socket: The socket aiming mechanism allows the lamp to be aimed straight down regardless of ceiling pitch
- Thermal protector: Self resetting thermal protector deactivates fixture if overheating occurs due to improper lamping or misapplied insulation
- UL Listed for damp location
- UL Listed for feed through wiring

Installation

- Bar hanger: Pre-installed nails easily install in regular or engineered lumber. Bar hangers are adjustable from 13-5/8" to 25" and can be repositioned 90 degree on plaster frame
- Junction box: Listed for through branch circuit wiring. Contains seven 7/8" knockouts and four Romex pryouts with strain relief



IC

Item #: RH6/NSL/IC/BOX

Order Code: 78119

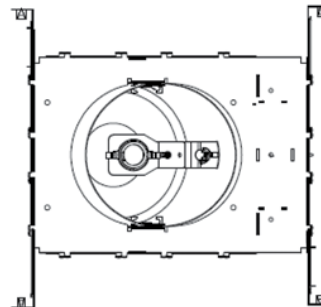
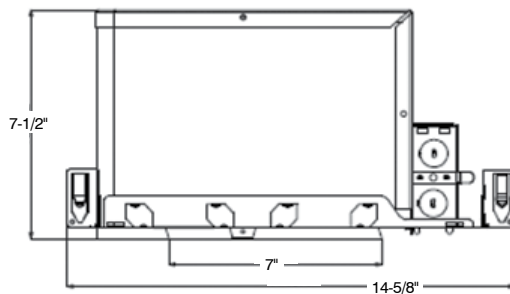

6" Line Voltage Remodel Housing for Sloped Ceilings

Features

- 75 watt max
- Housing: Designed for use in ceiling with slopes from 2/12 to 6/12
- Socket: The socket aiming mechanism allows the lamp to be aimed straight down regardless of ceiling pitch
- Thermal protector: Self resetting thermal protector deactivates fixture if overheating occurs due to improper lamping or misapplied insulation
- UL Listed for damp location
- UL Listed for feed through wiring
- Certified under ASTM-E283 for airtight construction

Installation

- Junction box: Listed for through branch circuit wiring. Contains six 7/8", one 1-1/8" knockouts and four Romex pryouts with strain relief



IC Airtight

Item #: RH6/RSL/IC/AT

Order Code: 79536

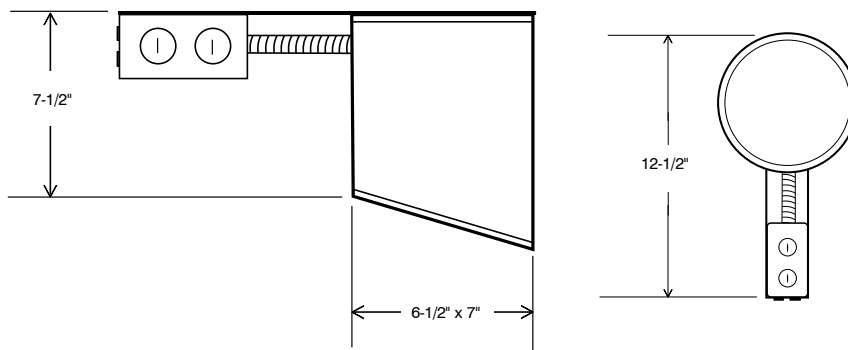

6" Line Voltage Trims for Sloped Ceilings



RT600CL/WH/SC

Clear Reflector with White Ring
Uses BR40, PAR38 Lamps
Order Code: 70026

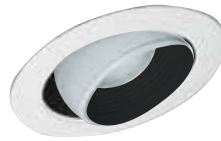
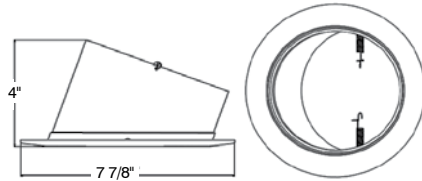

RT604BL/WH/SC

Black Baffle with White Eyeball
Uses BR/PAR30 Lamps
Order Code: RT604BL/WH/SC

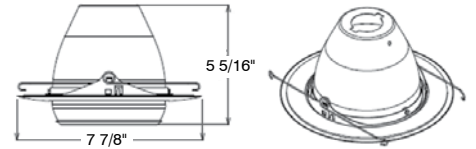

RT602BL/WH/SC

Black Baffle with White Ring
Uses BR40, PAR38 Lamps
Order Code: 70025

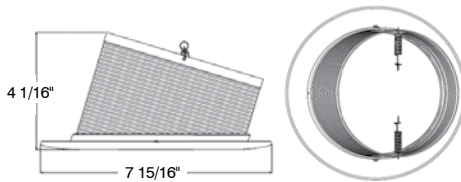

RT604WH/SC

White Baffle with White Eyeball
Uses BR/PAR30 Lamps
Order Code: 78129

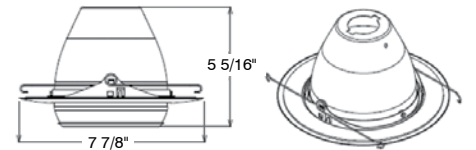

RT602WH/SC

White Baffle with White Ring
Uses BR40, PAR38 Lamps
Order Code: 78154

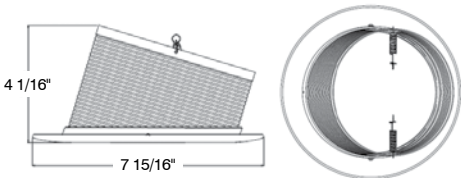

RT603WH/WH/SC

White Baffle with White Eyeball
Uses BR/PAR30 Lamps
Order Code: 78129

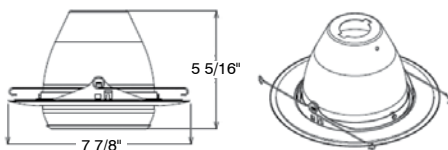

4" GU10 New Construction Housing

Features

- 50 watt max 120V GU10 MR16
- Thermal protector: Self resetting thermal protector deactivates fixture if overheating occurs due to improper lamping or misapplied insulation
- Plaster frame: Galvanized steel construction. The housing can be removed from plaster frame to provide access to the junction box
- UL Listed for damp location
- UL Listed for feed through wiring
- Certified under ASTM-E283 for airtight construction (RH4/NG/IC/AT only)

Installation

- Bar hanger: Pre-installed nails easily install in regular or engineered lumber. Bar hangers are adjustable from 13-5/8" to 25" and can be repositioned 90 degree on plaster frame
- Junction box: Listed for through branch circuit wiring. Contains seven 7/8" knockouts, and four Romex pryouts with strain relief



Non-IC

Item #: RH4/NG

Order Code: 79550



IC Airtight

Item #: RH4/NG/IC/AT

Order Code: 77704

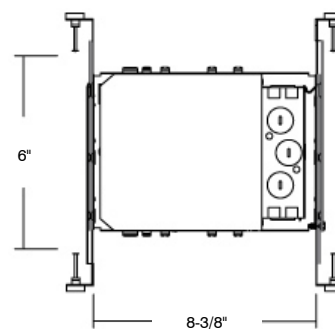
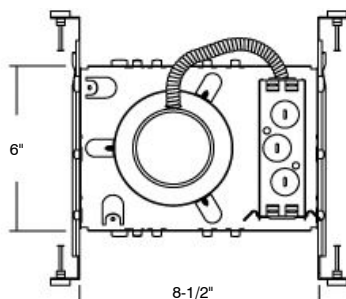
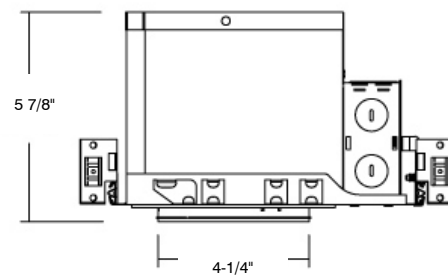
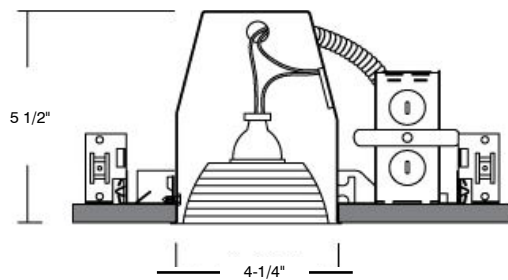

4" GU10 Remodel Construction Housing

Features

- 50 watt max 120V GU10 MR16
- Thermal protector: Self resetting thermal protector deactivates fixture if overheating occurs due to improper lamping or misapplied insulation.
- Remodel clips: Four remodel clips secure housing and accommodates 1/2" and 5/8" ceiling materials.
- UL Listed for damp location
- UL Listed for feed through wiring

Installation

- Junction box: Listed for through branch circuit wiring. Contains seven 7/8" knockouts and four Romex pryouts with strain relief.



Non-IC

Item #: RH4/RG

Order Code: 78282

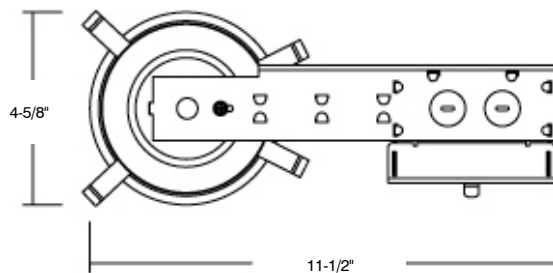
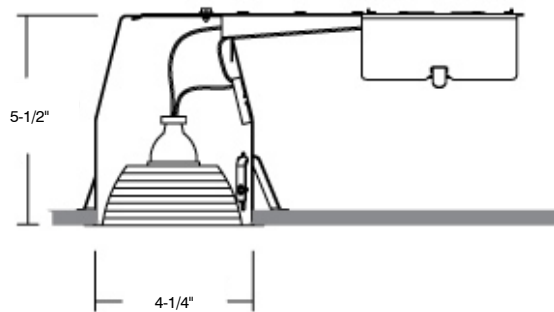

4" GU10 Line Voltage Recessed Trims



RT400CL/WH/LV
 Clear Reflector with White Ring
 Uses 50W 120V GU10 Lamps
 Order Code: 78356

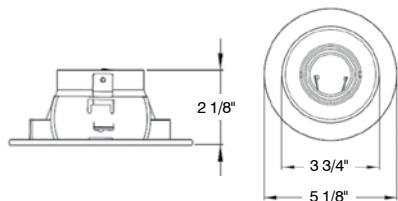

RT401WH/LV
 All Steel White Baffle with White Ring
 Uses 50W 120V GU10 Lamps
 Order Code: 79127

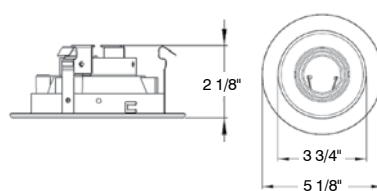

RT400WH/LV
 White Reflector with White Ring
 Uses 50W 120V GU10 Lamps
 Order Code: 79128

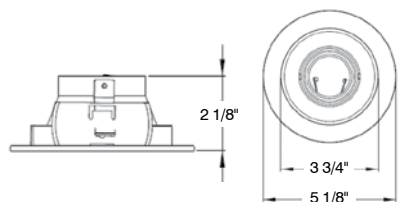

RT408BL/LV
 Black Slot Aperture
 Uses 50W 120V GU10 Lamps
 Order Code: 78166

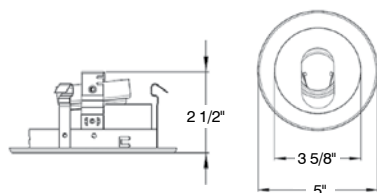

RT401BL/LV
 All Steel Black Baffle with Black Ring
 Uses 50W 120V GU10 Lamps
 Order Code: 78156

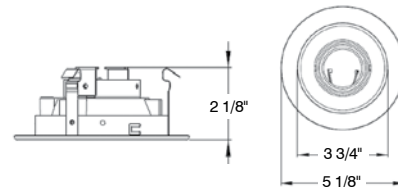

RT408WH/LV
 White Slot Aperture
 Uses 50W 120V GU10 Lamps
 Order Code: 78165

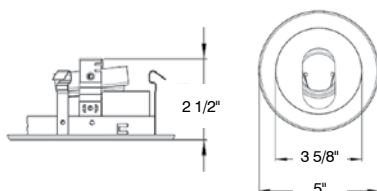

RT401BL/WH/LV
 All Steel Black Baffle with White Ring
 Uses 50W 120V GU10 Lamps
 Order Code: 71910

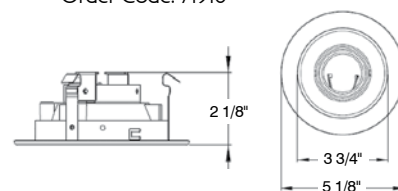

RT413WH/LV
 Deep Step Baffle with White Eyeball
 Uses 50W 120V GU10 Lamps
 Order Code: 78362

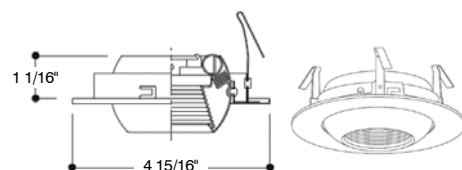

4" GU10 Line Voltage Recessed Trims



RT422CH/LV

Chrome Square Gimbal with
Chrome Square Body
Uses 50W 120V GU10 Lamps
Order Code: 78171

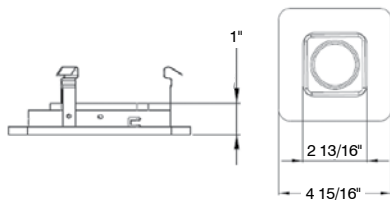

RT432CH/LV

Round Chrome Gimbal
Uses 50W 120V GU10 Lamps
Order Code: RT432CH/LV

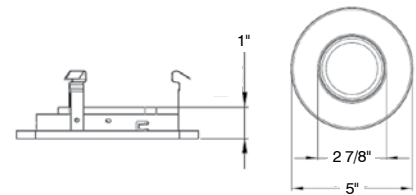

RT422WH/LV

White Square Gimbal with
White Square Body
Uses 50W 120V GU10 Lamps
Order Code: 77534

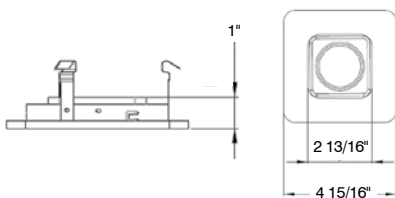

RT432WH/LV

Round White Gimbal
Uses 50W 120V GU10 Lamps
Order Code: 79169

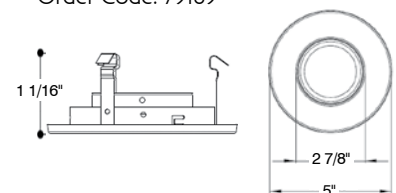

GU24 New Construction Housing

Features

- Socket for one 11-18W GU24 120V (RH4/NG/118/IC/AT)
- Socket for one 11-27W GU24 120V (RH6/NG/126/IC/AT)
- Housing: Single wall aluminum
- UL Listed for damp location
- UL Listed for feed through wiring
- Certified under ASTM-E283 for airtight construction
- ENERGY STAR qualified
- Meets TITLE 24 requirements

Installation

- Bar hanger: Pre-installed nails easily install in regular or engineered lumber. Bar hangers are adjustable from 13-5/8" to 25" and can be repositioned 90 degree on plaster frame
- Junction box: Listed for through branch circuit wiring. Contains seven 7/8" knockouts and four Romex pryouts with strain relief



4" IC Airtight

Item #: RH4/NG/118/IC/AT

Order Code: 79424

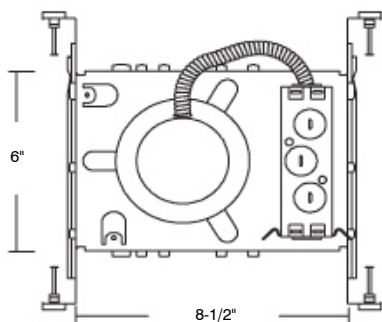
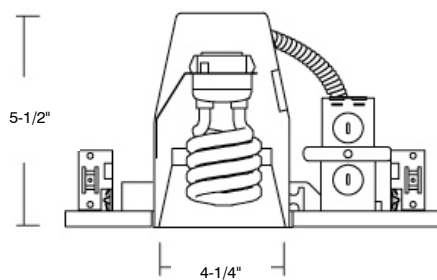

6" IC Airtight

Item #: RH6/NG/126/IC/AT

Order Code: 79425

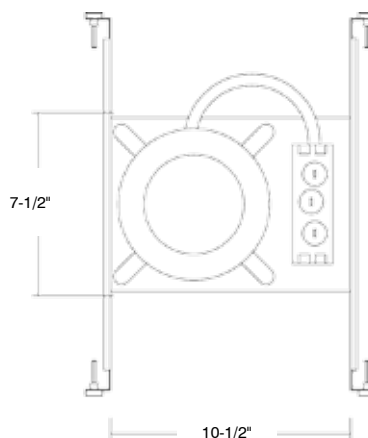
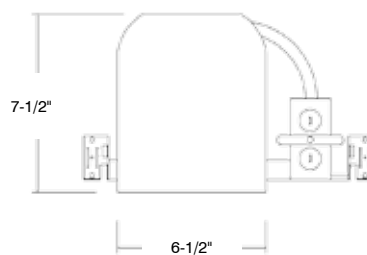

GU24 Remodel Housing

Features

- Socket for one 11-27W GU24 120V
- Housing: Single wall aluminum housing
- Remodel clips: Four remodel clips secure housing and accommodates 1/2" and 5/8" ceiling materials.
- UL Listed for damp location
- UL Listed for Feed Through wiring
- Certified under ASTM-E283 for Airtight construction
- ENERGY STAR qualified
- Meets TITLE 24 requirements

Installation

- Junction box: Listed for through branch circuit wiring. Contains seven 7/8", one 1-1/8" knockouts and four Romex pryouts with strain relief.



4" IC Airtight

Item #: RH4/RG/118/IC/AT

Order Code: 79416

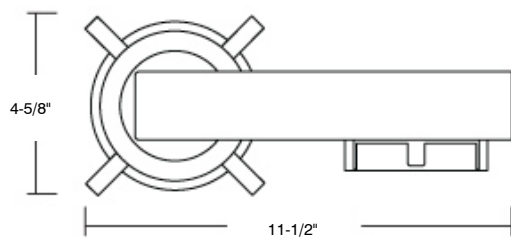
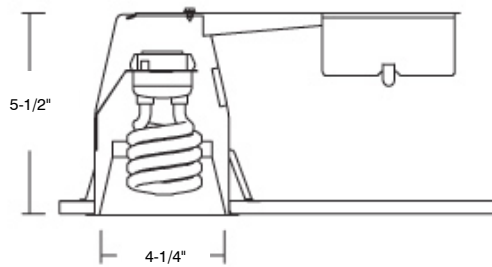

6" IC Airtight Vertical Mount

Item #: RH6/RG/126/IC/AT

Order Code: 79417

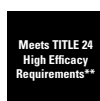
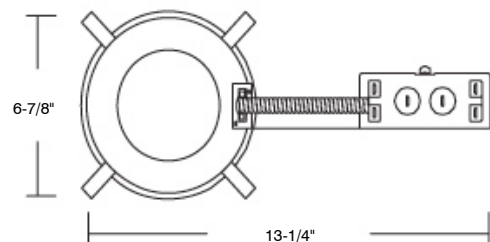
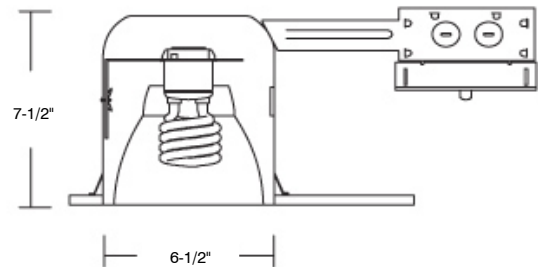

4" GU24 Recessed Trims



RT410CL/WH/G

White GU24 Trim with
Clear Deep Reflector
Uses 11-18W GU24 Lamps
Order Code: 79448

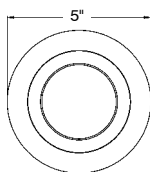
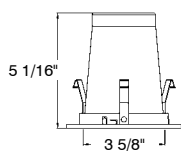

RT412WH/G

White Deep GU24 Stepped Baffle with
White Ring
Uses 11-18W GU24 Lamps
Order Code: 79447

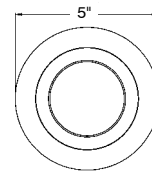
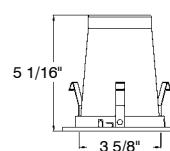

6" GU24 Recessed Trims



RT600WH/R30
 White Reflector with White Ring
 Uses 11-27W GU24 Lamps
 Order Code: 79162

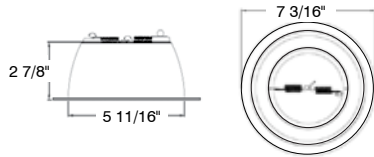

RT601WH
 White Step Baffle with White Ring
 Uses 11-27W GU24 Lamps
 Order Code: 79135

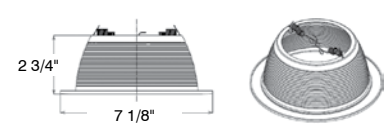

RT601BL
 Black Step Baffle with Black Ring
 Uses 11-27W GU24 Lamps
 Order Code: 79604

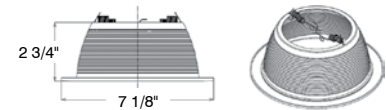

RT601BL/WH
 Black Step Baffle with White Ring
 Uses 11-27W GU24 Lamps
 Order Code: 77102

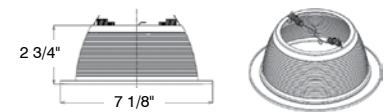

RT601SCH
 All Satin Chrome Step Baffle
 Uses 11-27W GU24 Lamps
 Order Code: 70960

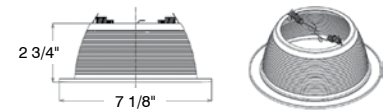

6" GU24 Recessed Trims



RT609WH/A
Albalite Lens Shower Trim with White Metal Ring
Uses 11-27W GU24 Lamps
Order Code: 79136

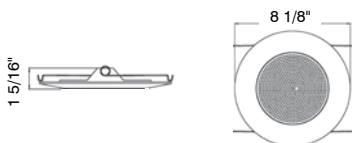

RT609WH/FL/P
Fresnel Glass Lens with White Plastic Ring
Uses 18-26W Quad/Triple Tube Lamps
Order Code: 79160

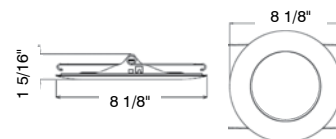

RT609WH/A/P
Albalite Lens Shower Trim with White Plastic Ring
Uses 11-27W GU24 Lamps
Order Code: 79137

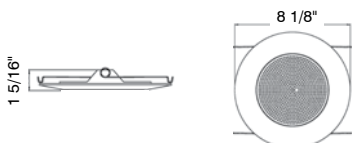

RT609WH/FR/P
Frosted Glass Lens with White Plastic Ring
Uses 11-27W GU24 Lamps
Order Code: 79155

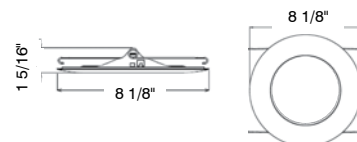

RT609WH/DO/P
Drop Opal Lens with White Plastic Ring
Uses 11-27W GU24 Lamps
Order Code: 75971

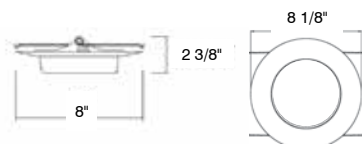

RT610CL/WH
Clear Deep Reflector with White Ring
Uses 11-27W GU24 Lamps
Order Code: 79156

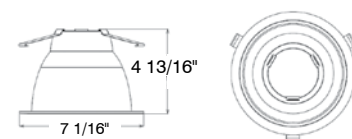

RT609WH/FL
Fresnel Glass Lens with White Metal Ring
Uses 11-27W GU24 Lamps
Order Code: 77559

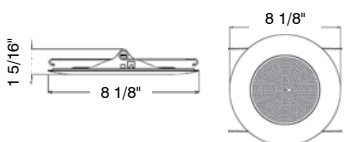

RT611BL/WH
Clear Deep Reflector with Black Step Baffle and White Ring
Uses 11-27W GU24 Lamps
Order Code: 79157

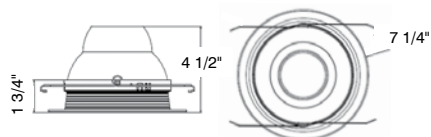

6" GU24 Recessed Trims



RT611WH

Clear Deep Reflector with White Step Baffle and White Ring
Uses 11-27W GU24 Lamps
Order Code: 79158

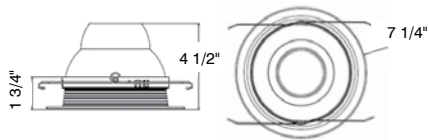

RT612WH

White Step Baffle with White Ring
Uses 11-27W GU24 Lamps
Order Code: 79159

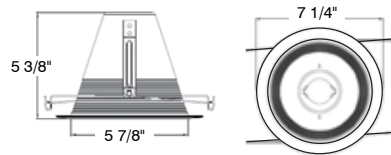

RT619WH/A/P

Albalite Shower Trim with Clear Deep Reflector and White Plastic Ring
Uses 11-27W GU24 Lamps
Order Code: 77572

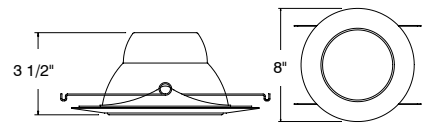

RT614C

Clear Deep Smooth Cone w/White Ring
Uses 11-27W GU24 Lamps
Order Code: 79851

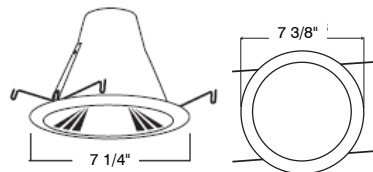

RT620WH

White Wall Wash
Uses 11-27W GU24 Lamps
Order Code: 78077

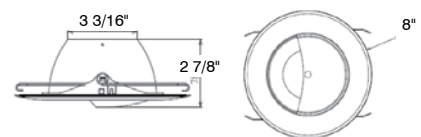

RT614GW

Gloss White Deep Smooth Cone
Uses 11-27W GU24 Lamps
Order Code: 79850

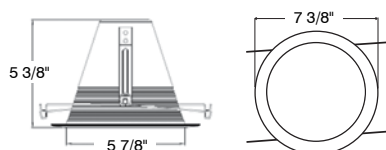

RT621WH

White Baffle with White Wall Wash
Uses 11-27W GU24 Lamps
Order Code: 77600

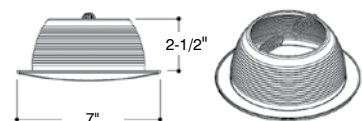



Low Voltage Recessed Downlighting

Topaz's residential/commercial low voltage housings and trims are the perfect choice for new and remodel construction. Available in 3 and 4 inch diameter openings to accommodate a wide array of 12V, MR16 trims to complement any style. Offered in both IC and Non-IC rated fixtures to meet local building code requirements. Topaz low voltage trims are available in 50W or 75W configurations.

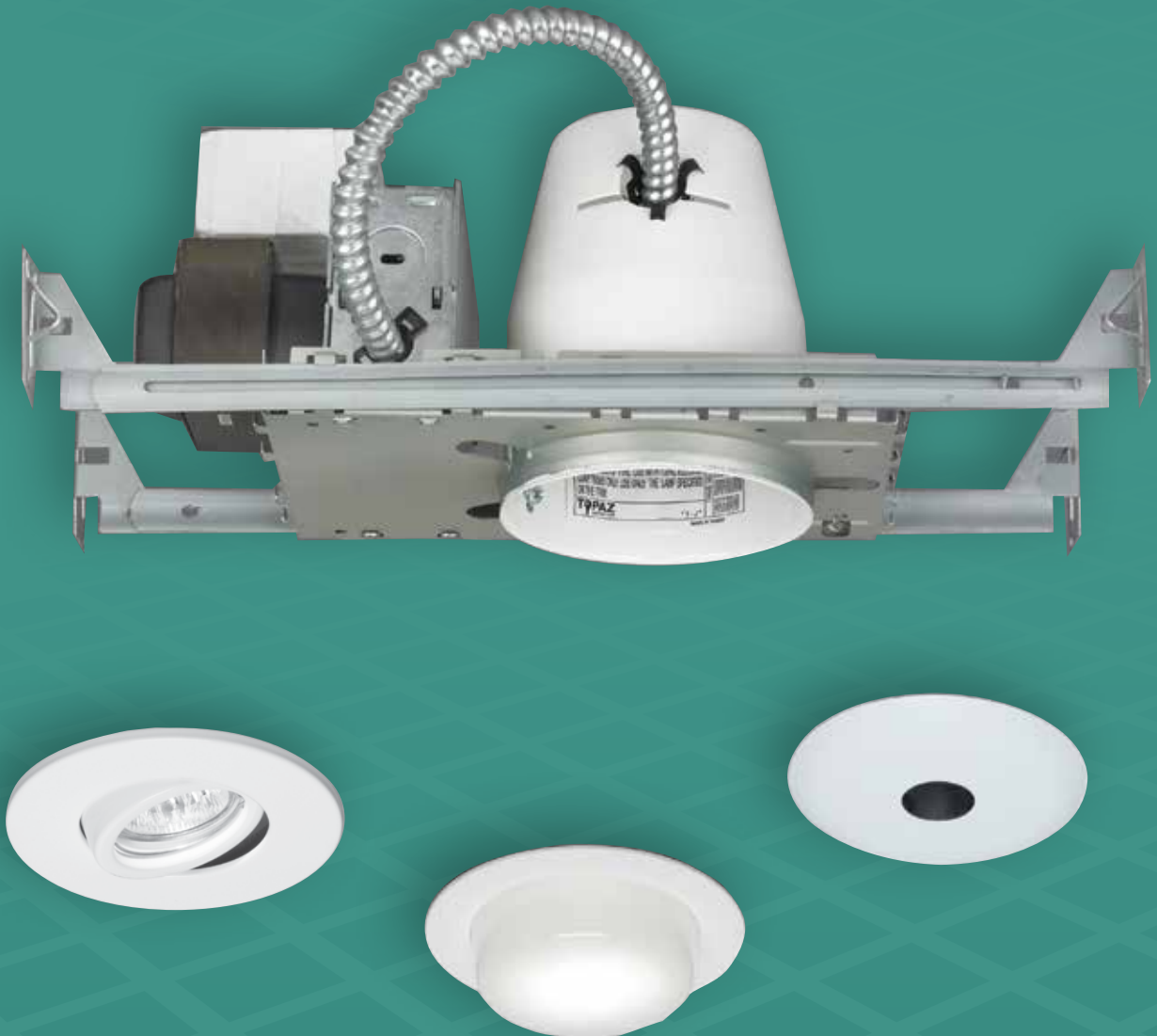

3" Low Voltage Remodel and New Construction Housings

Features

- 50 watt max. 12V MR16
- Plaster frame: Galvanized steel construction. The housing can be removed from plaster frame to provide access to the junction box
- Housing (RH3/NLV/IC/AT only): Double wall aluminum construction for greater heat dissipation. Housing adjusts for ceiling up to 1-1/4" thick
- Transformer: 120V Integral magnetic transformer steps line voltage down to lamp operating voltage. For lamps up to 50W.
- Thermal protector: Self resetting thermal protector deactivates fixture if overheating occurs due to improper lamping or misapplied insulation
- UL Listed for damp location
- UL Listed for feed through wiring
- Certified under ASTM-E283 for airtight construction (RH3/NLV/IC/AT only)

Installation

- Bar hanger: Pre-installed nails easily install in regular, or engineered lumber. Bar hangers are adjustable from 13-5/8" to 25" and can be repositioned 90 degrees on plaster frame
- Junction box: Listed for through branch circuit wiring. Contains six 7/8", one 1-1/8" knockouts and four Romex pryouts with strain relief



Non-IC

Item #: RH3/NLV

Order Code: 78339

(Remodel version available: Item # RH3/RLV/AT. Order Code: 78370)



IC Airtight

Item #: RH3/NLV/IC/AT

Order Code: 77531

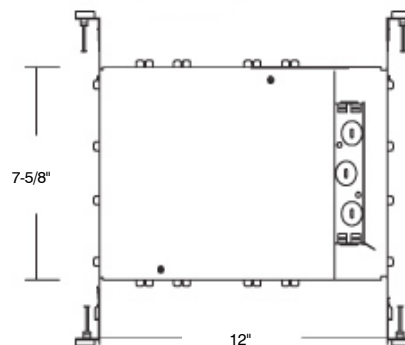
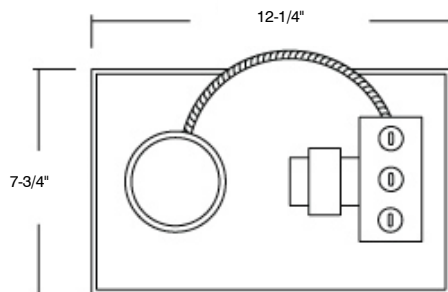
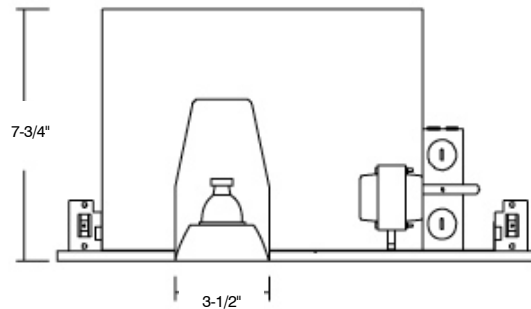
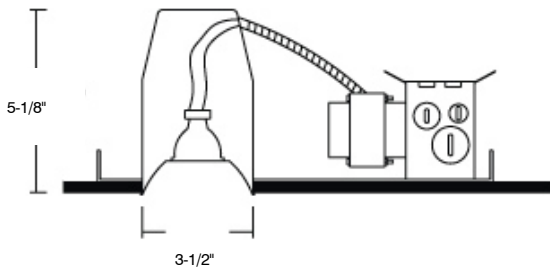

3" Low Voltage Remodel and New Construction Housings

Features

- 50 watt max. 12V MR16
- Plaster frame: (RH3/NLV/S) Galvanized steel construction. Housing can be removed from plaster frame to provide access to the junction box
- Thermal protector: Self resetting thermal protector deactivates fixture if overheating occurs due to improper lamping or misapplied insulation
- Remodel clips and support spring (RH3/RLV/S): Three remodel clips secure housing and accommodates 1/2" and 5/8" ceiling materials and support spring helps support weight of junction box and transformer. Automatically adjusts for different ceiling materials
- Transformer: 120V Integral magnetic transformer steps line voltage down to lamp operating voltage
- UL Listed for damp location
- UL Listed for feed through wiring
- Certified under ASTM-E283 for airtight construction

Installation

- Junction box: Listed for through branch circuit wiring. (RH3/NLV/S) contains three 7/8" knockouts, three 1-1/8" and four Romex pryouts with strain relief. (RH3/RLV/S) contains four 7/8" knockouts with strain relief
- Bar hanger: (RH3/NLV/S) Pre-installed nails easily install in regular, or engineered lumber. Bar hangers are adjustable from 13-5/8" to 25" and can be repositioned 90 degrees on plaster frame



Shallow Non-IC

Item #: RH3/NLV/S

Order Code: 79974

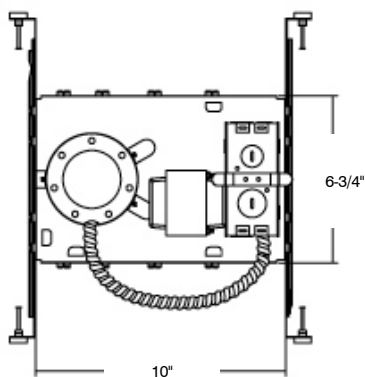
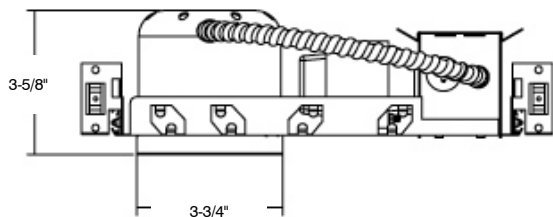

Shallow Non-IC

Item #: RH3/RLV/S

Order Code: 79975

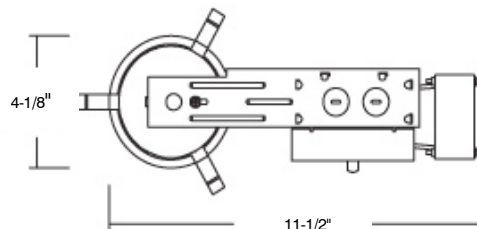
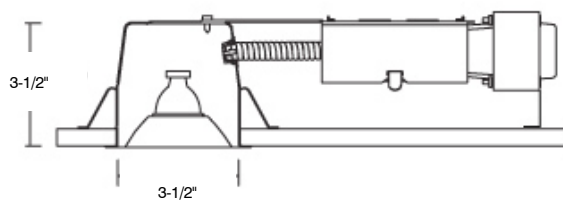

4" Low Voltage New Construction Housing

Features

- 50 watt max. 12V MR16 (RH4/NLV and RH4/NLV/S)
75 watt max. 12V MR16 (RH4/NLV/HW)
- Plaster frame: Galvanized steel construction. Housing can be removed from plaster frame to provide access to the junction box
- Transformer: 120V Integral magnetic transformer steps line voltage down to lamp operating voltage. For lamps up to 50W (RH4/NLV and RH4/NLV/S), and up to 75W (RH4/NLV/HW)
- Thermal Protector: Self resetting thermal protector deactivates fixture if overheating occurs due to improper lamping or misapplied insulation
- UL Listed for damp location
- UL Listed for feed through wiring

Installation

- Bar hanger: Pre-installed nails easily install in regular, or engineered lumber. Bar hangers are adjustable from 13-5/8" to 25" and can be repositioned 90 degrees on plaster frame
- Junction box: Listed for through branch circuit wiring. (RH4/NLV and RH4/NLV/HW) contain seven 7/8" knockouts and four Romex pryouts with strain relief. (RH4/NLV/S) contains one 1-1/8", one 5/8", and three 7/8" knockouts and four Romex pryouts with strain relief



Non-IC Non-IC High Wattage

Item #: RH4/NLV

Order Code: 77667

Item #: RH4/NLV/HW

Order Code: 78340



Shallow Non-IC

Item #: RH4/NLV/S

Order Code: 78340

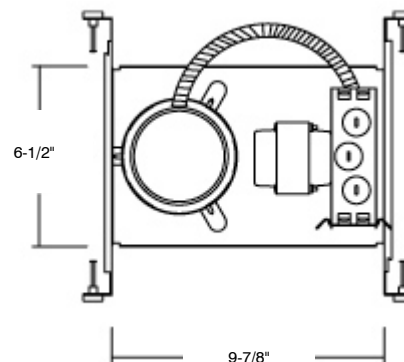
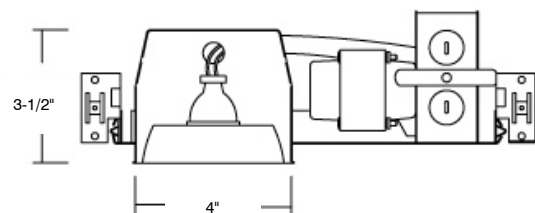
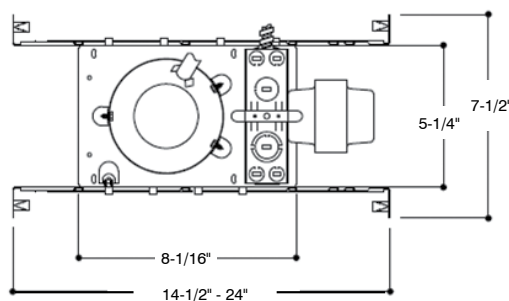
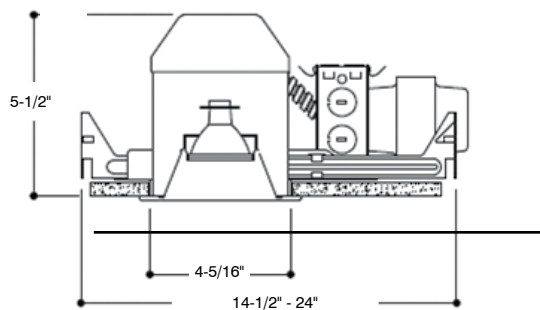

4" Low Voltage New Construction Housing

Features

- 50 watt max. 12V MR16
- Plaster frame: Galvanized steel construction. Housing can be removed from plaster frame to provide access to the junction box
- Housing: Double wall aluminum construction for greater heat dissipation. Gasketed to prevent airflow from heated or air conditioned space. Housing adjusts for ceiling up to 1-1/4" thick
- Transformer: 120V Integral magnetic transformer steps line voltage down to lamp operating voltage. For lamps up to 50W
- Thermal protector: Self resetting thermal protector deactivates fixture if overheating occurs due to improper lamping or misapplied insulation
- UL Listed for damp location
- UL Listed for feed through wiring
- Certified under ASTM-E283 for airtight construction

Installation

- Bar hanger: Pre-installed nails easily install in regular, or engineered lumber. Bar hangers are adjustable from 13-5/8" to 25" and can be repositioned 90 degrees on plaster frame
- Junction box: Listed for through branch circuit wiring. Contains seven 7/8" knockouts and four Romex pryouts with strain relief



IC Airtight

Item #: RH4/NLV/IC/AT

Order Code: 79138

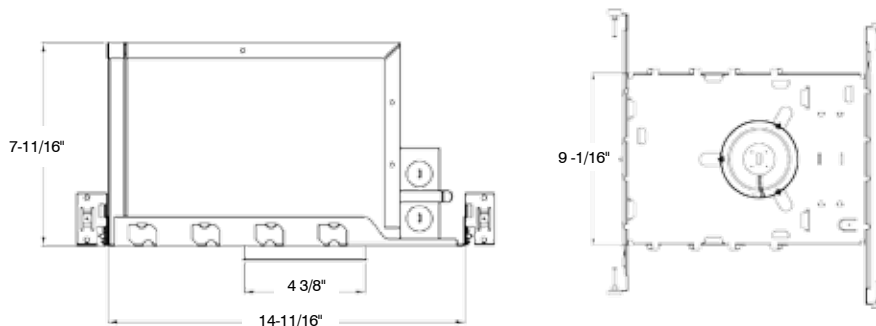

4" Low Voltage Remodel Construction Housing

Features

- 50 watt max 12V MR16 (RH4/RLV and RH4/RLV/S), 75 watt max 12V MR16 (RH4/RLV/HW)
- Thermal protector: Self resetting thermal protector deactivates fixture if overheating occurs due to improper lamping or misapplied insulation
- Remodel clips: Four remodel clips secure housing and accommodates 1/2" and 5/8" ceiling materials.
- Support spring: Support spring helps support weight of junction box and transformer. Automatically adjusts for different ceiling materials
- Transformer: 120V Integral magnetic transformer steps line voltage down to lamp operating voltage. For lamps up to 50W (RH4/RLV and RH4/RLV/S), and up to 75W (RH4/RLV/HW)
- UL Listed for damp location
- UL Listed for feed through wiring

Installation

- Junction box: Listed for through branch circuit wiring. (RH4/RLV) contains seven 7/8" knockouts and four Romex pryouts with strain relief. (RH4/RLV/HW and RH4/RLV/S) contains six 7/8" knockouts and four Romex pryouts with strain relief



Non-IC

Item #: RH4/RLV

Order Code: 77532

Non-IC High Wattage

Item #: RH4/RLV/HW

Order Code: 77668



Shallow Non-IC

Item #: RH4/RLV/S

Order Code: 79977

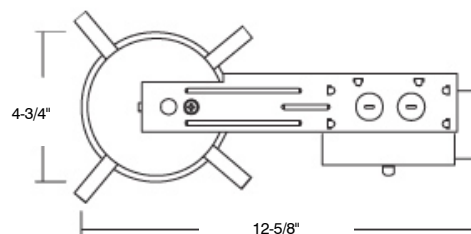
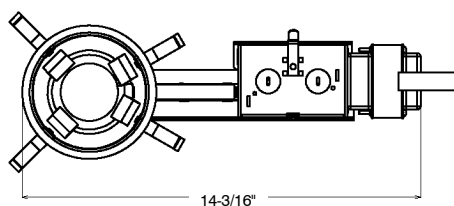
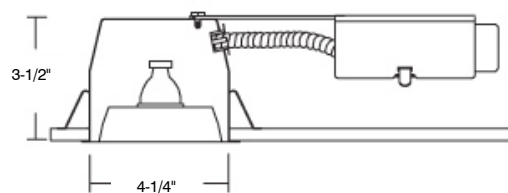
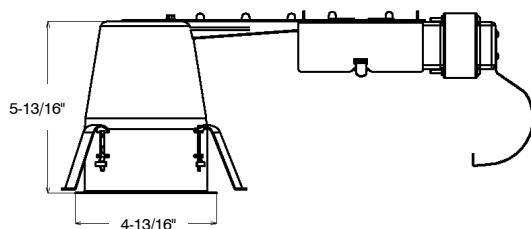

3" and 4" Low Voltage Trims

3" Trims



RT301SN

All Satin Nickel Baffle Trim
Uses 50W 12V MR16 Lamps
Order Code: 79950

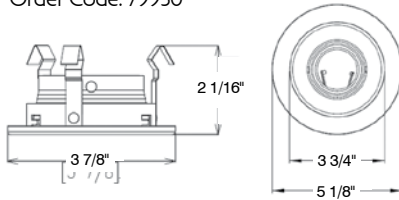

4" Trims



RT400CL/CH/LV

Clear Reflector with Chrome Ring
Uses 50W 12V MR16 Lamps
Order Code: 78161

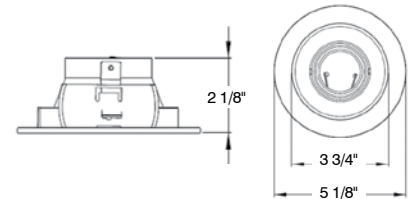

RT332WH

Round White Gimbal
Uses 50W 12V MR16 Lamps
Order Code: 78131

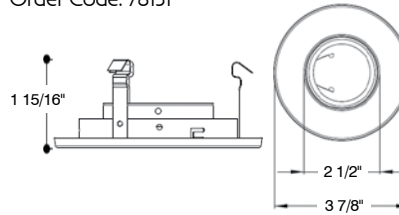

RT400CL/WH/LV

Clear Reflector with White Ring
Uses 50W 12V MR16 Lamps
Order Code: 78356

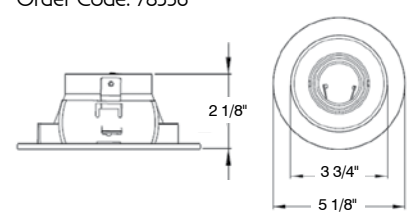

RT301WH

White Baffle with White Ring
Uses 50W 12V MR16 Lamps
Order Code: 79611

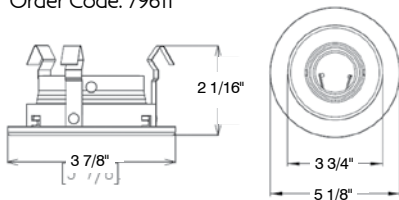

RT400WH/LV

White Reflector with White Ring
Uses 50W 12V MR16 Lamps
Order Code: 79128

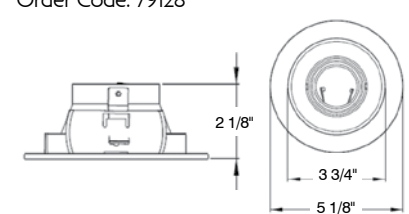

RT332SN

Round Satin Nickel Gimbal
Uses 50W 12V MR16 Lamps
Order Code: 79952

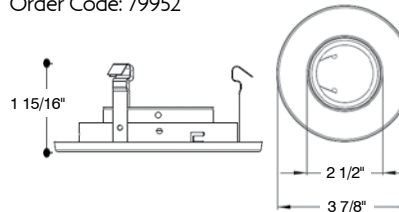

RT401BL/LV

All Steel Black Baffle with Black Ring
Uses 50W 12V MR16 Lamps
Order Code: 78729

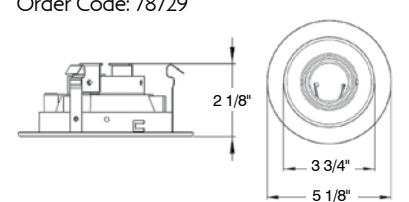

4" Low Voltage Trims



RT401BL/WH/LV

All Steel Black Baffle with White Ring
Uses 50W 12V MR16 Lamps
Order Code: 79262

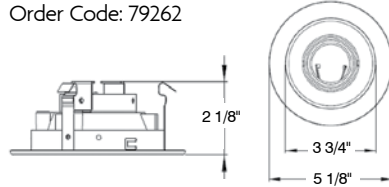

RT408BL/LV

Black Slot Aperture
Uses 50W 12V MR16 Lamps
Order Code: 78166

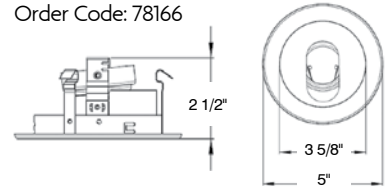

RT401SCH/LV

All Steel Satin Baffle with Satin Ring
Uses 50W 12V MR16 Lamps
Order Code: 78159

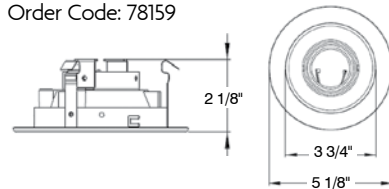

RT408WH/LV

White Slot Aperture
Uses 50W 12V MR16 Lamps
Order Code: 78165

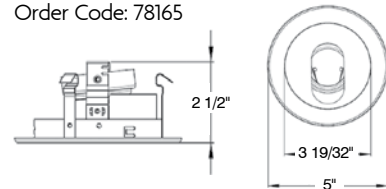

RT401WH/LV

All Steel White Baffle with White Ring
Uses 50W 12V MR16 Lamps
Order Code: 79127

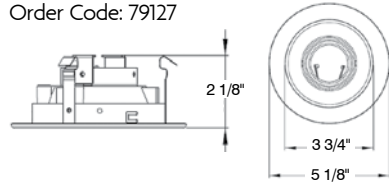

RT409WH/DO/LV

Drop Opal Shower Trim
Uses 50W 12V MR16 Lamps
Order Code: 78178

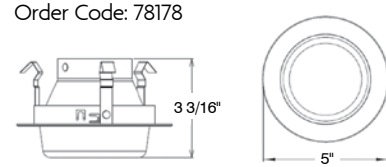

RT406WH/LV

Shallow White Baffle with White Gimbal
Uses 50W 12V MR16 Lamps
Order Code: 77669

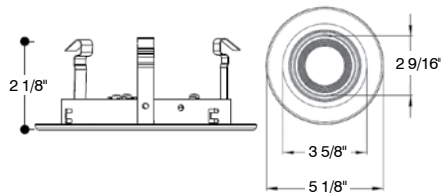

RT409WH/FL/LV

Fresnel Glass with White Trim
Uses 50W 12V MR16 Lamps
Order Code: 77670

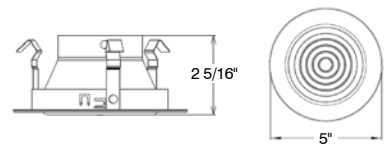

RT407WH/LV

White Pin Hole
Uses 50W 12V MR16 Lamps
Order Code: 72020

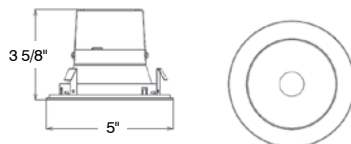

RT413BL/BL/LV

Deep Black Baffle with Black Eyeball
Uses 50W 12V MR16 Lamps
Order Code: RT413BL/BL/LV

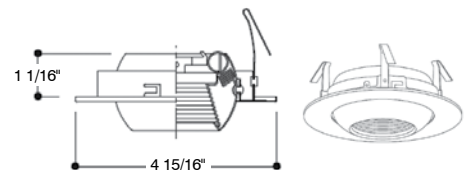

4" Low Voltage Trims



RT413WH/LV

Deep White Baffle with White Eyeball
Uses 50W 12V MR16 Lamps
Order Code: 78362

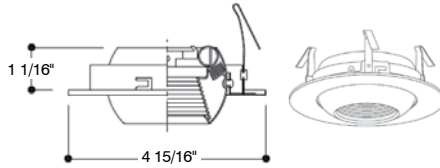

RT431WH/LV

Deep White Baffle with Round White Gimbal
Uses 50W 12V MR16 Lamps
Order Code: 431WH/LV

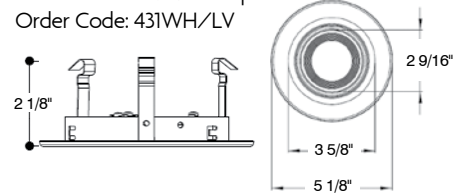

RT421WH/LV

All White Baffle Wall Wash
Uses 50W 12V MR16 Lamps
Order Code: 78279

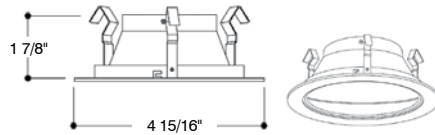

RT432NK/LV

Round Brushed Nickel Gimbal
Uses 50W 12V MR16 Lamps
Order Code: 78176

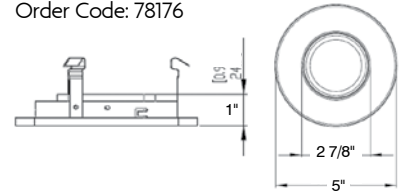

RT422CH/LV

Chrome Square Gimbal with Chrome Square Body
Uses 50W 12V MR16 Lamps
Order Code: 78171

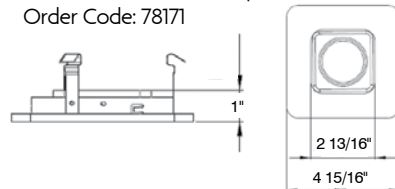

RT432WH/LV

Round White Gimbal
Uses 50W 12V MR16 Lamps
Order Code: 79169

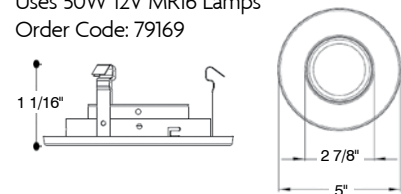

RT422WH/LV

White Square Gimbal with White Square Body
Uses 50W 12V MR16 Lamps
Order Code: 77534

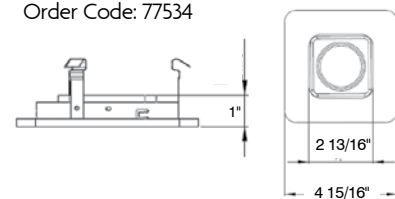

RT436NK/LV

Die-cast Nickel Rotating Beacon
Uses 50W 12V MR16 Lamps
Order Code: RT436NK/LV

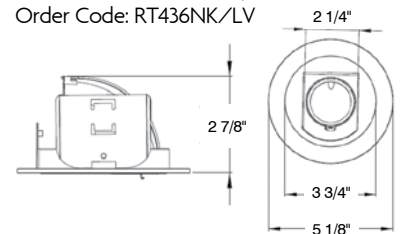

RT431BL/LV

Deep Black Baffle with Round Black Gimbal
Uses 50W 12V MR16 Lamps
Order Code: RT431BL/LV

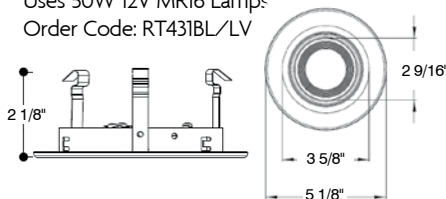

RT436WH/LV

Die-cast White Rotating Beacon
Uses 50W 12V MR16 Lamps
Order Code: 79554

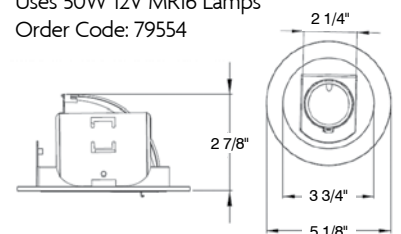

Accessories



RFA-ADPT-E26-E26
Ceramic Extension Socket (E26-E26)
Order Code: 78230



RFA-C-HB
2 piece set of C-Channel Hanger Bars
Order Code: 77966



RFA-ADPT-E26-GU24
Socket Adapter (E26-GU24)
Order Code: 78228



RFA-LV-XFMR-50
120V to 12VAC/50W
Magnetic Replacement Transformer
Mounted on J-box Cover
(For use with recessed housings
RH4/NLV and RH4/RLV)
Order Code: 77530



RFA-CLIP
Universal Remodel Clips (Set)
Order Code: 78218

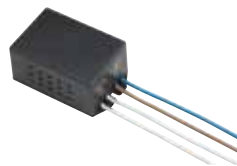

RFA-LV-XFMR-50EL/220
220V to 12VAC/50W
Electronic Replacement Transformer
(Not for use with recessed housings)
Order Code: 78227



RFA-LV-GC
Glass Cover for Louver Trim
Order Code: 72111



RFA-LV-XFMR-50EL
120V to 12VAC/50W
Electronic Replacement Transformer
(Not for use with recessed housings)
Order Code: 78225



RFA-HB
1 Set Male-Female Hanger Bar
Order Code: 75099



RFA-LV-XFMR-75EL
120V to 12VAC/75W
Electronic Replacement Transformer
(Not for use with recessed housings)
Order Code: 78226

Accessories



RFA-SKT-GU10
GU10 Socket
Order Code: 78219



RFA-SPRING
Straight Coil Spring
Order Code: 74100

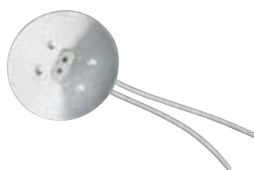

RFA-SKT-GU5.3
MR16 Socket with Heat Shield
Order Code: 72110



RFA-TR-OV6-BL
8-1/2" Black Ring
Order Code: 78221



RFA-SKT-TP-E26
Base Plate with Removable Socket
and Thermal Protector
Order Code: 78215



RFA-TR-OV6-BR
8-1/2" Brass Ring
Order Code: 78223



RFA-SPR-V
Torsion Spring
Order Code: 78217



RFA-TR-OV6-C
8-1/2" Chrome Ring
Order Code: 78222

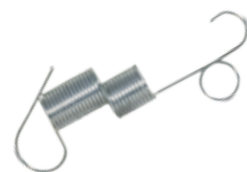

RFA-SPR-COIL
Split Coil Spring
Order Code: 74101



RFA-TR-OV6-W
8-1/2" White Ring
Order Code: 74104

Nomenclature

Housings

Series	Aperture Size	Lamp Orientation	Construction	Lamp Style	# of Lamps	Lamp Wattage	Insulation Contact	Airtight	Voltage	Options
RH = Recessed Housing	3	Blank = Vert	Blank = Standard Depth Housing	Blank = Incand.	1 or 2	Blank = Incand.	Blank = Non-IC	Blank = Non-AT	Blank = 120	Any
	4	H = Hor	R = Remodel	C = CFL		Insert wattages for CFL, GU	IC = IC	AT = AT	H = 120/277	Modifications
	5		N = New	G = GU					HW = High Wattage	
	6		S = Shallow SL = Slope SSL = Super Slope	LV = Low Voltage						

Trims

Series	Aperture Size	2X #	Trim Color	Ring Color	Lamp Type/ Wattage	Airtight	Options
RT = Recessed Trim	3	See Below	WH = White	Blank = Same color as trim	Blank = Incandescent	Blank = Non-AT or insert 'AT'	Used for trims with both plastic and metal rings, different lensing, etc
	4		BL = Black	WH = White	C = CFL		
	5		CH = Chrome	BL = Black	G = GU		
	6		NK = Satin Nickel CL = Clear GO = Gold	CH = Chrome NK = Satin Nickel	LV = Low Voltage		

Trim Numbering System

00 = Smooth Reflector	04 = Open Ring	08 = Slot	12 = Deep Baffle	16 = Deep Gimbal	20 = Wall Wash
01 = Baffle	05 = Open Ring	09 = Shower	13 = Baffle Eyeball	17 = Shallow Baffle	21 = Baffle Wall Wash
02 = Baffle	06 = Gimbal	10 = Deep Smooth Reflector	14 = OPEN	18 = OPEN	
03 = Eyeball	07 = Pin Hole	11 = Deep Reflector w/Baffle	15 = OPEN	19 = Deep Shower	



The Topaz Difference

At Topaz you get a personal assistant assigned to your account—a single point of contact to rely on to get 100% of your needs met...fast. In addition to our award winning service, we are committed to providing you with:

VALUE PRICING – As a manufacturer, we believe in providing you with quality products, value priced, so that both you and your customers can benefit and grow your businesses.

DIRECT SHIPMENTS – There are times when your customer may need a product in a hurry. At your request, we will ship directly to your customers from our warehouse.

Topaz also delivers key value-added services to make sure you can serve your customers better.



We are well known for the depth and breadth of our inventory. FullFill reflects our promise that we can fill over 99% of the orders we receive from existing inventory.



Just give us your order by 4PM and in most cases, we will get your order out before 5PM on the same day.

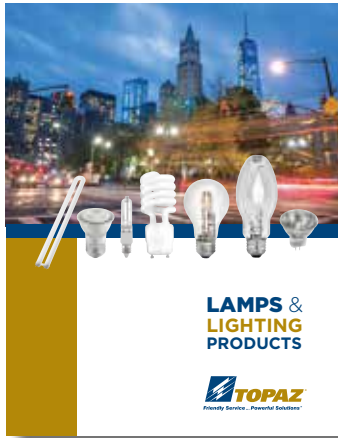

To see our complete product line visit us at ...

www.topaz-usa.com



Index

BEL12/12-48V	7, 39	F-L22/40/835/D/HE	7	RFA-ADPT-E26-GU24	96
F-ARL/150W/50K/SF	53	F-L22/40/840/D/HE	7	RFA-C-HB	96
F-ARL/300W/50K/SF	53	F-L22/40/850/D/HE	7	RFA-CLIP	96
F-ARL/150W/50K/TR	53	F-L24/38/830/D/HP	7	RFA-LV-GC	96
F-ARL/300W/50K/TR	53	F-L24/38/835/D/HP	7	RFA-HB	96
F-AWP-30/50K/BZ	41	F-L24/38/840/D/HP	7	RFA-LV-XFMR-50	96
F-AWP-40/50K/BZ	41	F-L24/38/850/D/HP	7	RFA-LV-XFMR-50EL	96
F-AWP-70/50K/BZ	41	F-L24/50/835/D/HE	7	RFA-LV-XFMR-50EL/220	96
F-AWP-90/50K/BZ	41	F-L24/50/840/D/HE	7	RFA-LV-XFMR-75EL	96
F-CNPY-45WLED-LP	47	F-L24/50/850/D/HE	7	RFA-SKT-GU10	97
F-CNPY-70WLED-LP	47	F-L2X2-FRAME	7	RFA-SKT-GU5.3	97
F-CNPY-RND40W/50K-BZ	49	F-L2X4-FRAME	7	RFA-SKT-TP-E26	97
F-CNPY-RND40W/50K-WH	49	F-L4/40W/40K/D	14	RFA-SPR-COIL	97
F-CNPY-RND60W/50K-BZ	49	F-L4/40W/50W/D	14	RFA-SPRING	97
F-CNPY-RND60W/50K-WH	49	F-LED/4/36W/40/D	13	RFA-SPR-V	97
F-D2D-45WLED KIT	51	F-LED-CABLE 4PK	7	RFA-TR-OV6-BL	97
F-D2D-70WLED KIT	51	F-LED-CABLE 6PK	7	RFA-TR-OV6-BR	97
F-D2D-70WLED KIT-80G	51	F-LHB160/50K/480V	17	RFA-TR-OV6-C	97
F-FL/PL-ADPT-90DEG	53	F-LHB160/50K/UNV	17	RFA-TR-OV6-W	97
F-FL/PL-ADPT-SQ-RND	53	F-LUHB/150/50K	18	RH3/NLV	88
F-FL/PL-POLE MOUNT	53	F-LUHB150/50/HT	19	RH3/NLV/IC/AT	88
F-FL/WP-40WLED	37	F-LUHB150/50/HT/480V	19	RH3/NLV/S	89
F-FL/WP-60WLED	37	F-LUHB150/50/HTS	19	RH3/RLV/S	89
F-FL-13/50K/KN/BZ	35	F-LUHB150/50/HTS/480	19	RH4/N	56
F-FL-30/50K/KN/BZ	35	F-LWRAP/42W/40K	15	RH4/N/IC/AT	56
F-FL-50/50K/TR/BZ	35	F-LWRAP/42W/50K	15	RH4/NG	76
F-FLC-20WLED	33	F-VTA22/40/835/D	9	RH4/NG/118/IC/AT	80
F-FL-KNMOUNT	37	F-VTA22/40/840/D	9	RH4/NG/IC/AT	76
F-FL-SFMOUNT	37	F-VTA22/40/850/D	9	RH4/NLED/IC/AT	29
F-FL-TRMOUNT	37	F-VTA24/65/835/D	9	RH4/NLV	90
F-FM6/10/RN/P/30/WH	21	F-VTA24/65/840/D	9	RH4/NLV/HW	90
F-FM8/12/RN/P/30/WH	21	F-VTA24/65/850/D	11	RH4/NLV/IC/AT	91
F-FM10/15/DC/P/30/BN	21	F-VTC22/30/835/D	11	RH4/NLV/S	90
F-FM11/15/FN/G/30/BN	21	F-VTC22/30/840/D	11	RH4/R/AT	57
F-FM11/15/RN/P/30/WH	21	F-VTC22/30/850/D	11	RH4/RG	77
F-FM11/15/TL/G/30/BN	21	F-VTC24/45/835/D	11	RH4/RG/118/IC/AT	81
F-FM11/15/TL/G/30/WH	21	F-VTC24/45/840/D	11	RH4/RLED/IC/AT	28
F-FM12/20/DC/P/30/BN	21	F-VTC24/45/850/D	11	RH4/RLV	92
F-FM14/22/DC/P/30/BN	21	F-WP-135LED/50K	39	RH4/RLV/HW	92
F-L14/32/830/D/HP	7	F-WP-45LED/50K	39	RH4/RLV/S	92
F-L14/32/835/D/HP	7	F-WP-70LED/50K	39	RH5/N/IC/AT	60
F-L14/32/840/D/HP	7	F-WP-90LED/50K	39	RH5/NLED/IC/AT	29
F-L14/32/850/D/HP	7	F-WPM-40WLED-FC	43	RH5/R/IC/AT	61
F-L1X4-FRAME	7	F-WP-PHOTOCELL	39	RH5/RLED/IC/AT	28
F-L22/32/830/D/HP	7	F-WPS-17WLED	45	RH6/N/IC/ATS	62
F-L22/32/835/D/HP	7	F-WPS-17WLED-WH	45	RH6/N/IC/ATS/FL	62
F-L22/32/840/D/HP	7	F-WPS-29WLED	39	RH6/N/ICS	63
F-L22/32/850/D/HP	7	RFA-ADPT-E26-E26	96	RH6/N/S/IC	64

Index

RH6/N/S/IC/AT	64	RT421WH	59	RT609WH/FL	70, 84
RH6/NG/126/IC/AT	80	RT421WH/LV	95	RT609WH/FL/P	70, 84
RH6/NLED/IC/AT	29	RT422CH/LV	79, 95	RT609WH/FR/P	70, 84
RH6/NSL/IC/AT	72	RT422WH/LV	79, 95	RT610CL/WH	70, 84
RH6/NSL/IC/BOX	73	RT429WH	59	RT611BL/WH	84
RH6/R/IC	65	RT431BL/LV	95	RT611WH	70, 85
RH6/R/IC/AT	65	RT431WH/LV	95	RT612WH	70, 85
RH6/R/S	66	RT432CH/LV	79	RT613WH/R	71
RH6/R/S/IC	67	RT432NK/LV	95	RT614C	85
RH6/R/S/IC/AT	67	RT432WH/LV	79, 95	RT614GW	71, 85
RH6/RG/126/IC/AT	81	RT436NK/LV	95	RT619WH/A/P	85
RH6/RLED/IC/AT	28	RT436WH/LV	95	RT620WH	85
RH6/RSL/IC/AT	74	RT500CL/WH	61	RT621WH	85
RT301SN	93	RT501WH	61	RTL/420WH/ECO/D	27
RT301WH	93	RT502WH	61	RTL/423WH/90/D	26
RT332SN	93	RT509WH/A	61	RTL/430WH/ECO/D	27
RT332WH	93	RT509WH/FL	61	RTL/433WH/90/D	26
RT400CL/CH/LV	93	RT600CL/CH/R30	68	RTL/437WH/90/D	25
RT400CL/WH	58	RT600CL/WH/R30	68	RTL/43SQ/WH/90/D	24
RT400CL/WH/LV	78, 93	RT600CL/WH/R40	68	RTL/440WH/ECO/D	27
RT400WH	58	RT600CL/WH/SC	75	RTL/443WH/90/D	26
RT400WH/LV	78, 93	RT600GO/WH/R30	68	RTL/447WH/90/D	25
RT401BL	58	RT600WH/R30	68, 83	RTL/445SQ/WH/90/D	24
RT401BL/BAFF	58	RT601BL	68, 83	RTL/450WH/ECO/D	27
RT401BL/CH	58	RT601BL/WH	68, 83	RTL/620WH/ECO/D	27
RT401BL/LV	78, 93	RT601SCH	68, 83	RTL/623WH/90/D	26
RT401BL/PB	58	RT601WH	68, 83	RTL/630WH/ECO/D	27
RT401BL/WH	58	RT602BL	68	RTL/633WH/90/D	26
RT401BL/WH/LV	78, 94	RT602BL/WH	69	RTL/637WH/90/D	25
RT401SCH/LV	94	RT602BL/WH/AT	69	RTL/635SQ/WH/90/D	24
RT401WH	58	RT602BL/WH/SC	75	RTL/640WH/ECO/D	27
RT401WH/LV	78, 94	RT602GW/AT	69	RTL/643WH/90/D	26
RT403BL	59	RT602GW/AT/FS	69	RTL/647WH/90/D	25
RT403WH	59	RT602SCH	69	RTL/645SQ/WH/90/D	24
RT406BL	59	RT602WH	69	RTL/650WH/ECO/D	27
RT406WH	59	RT602WH/AT	69	RTLED/RETRO/GU24	28
RT406WH/LV	94	RT602WH/SC	75	SDL4/12/930/D	23
RT407WH/LV	94	RT603BL	69	SDL4/12/930/D/CC	23
RT408BL/LV	78, 94	RT603WH	69	SDL4/12/940/D	23
RT408WH/LV	78, 94	RT603WH/WH/SC	75	SDL4/12/940/D/CC	23
RT409WH/A	59	RT604BL/WH/SC	75	SDL6/15/930/D	23
RT409WH/DO/LV	94	RT604SCH	69	SDL6/15/930/D/CC	23
RT409WH/FL	59	RT604WH	70	SDL6/15/940/D	23
RT409WH/FL/LV	94	RT604WH/SC	75	SDL6/15/940/D/CC	23
RT410CL/WH/G	82	RT605WH	70	WD-SP	39
RT412WH/G	82	RT609WH/A	70, 84		
RT413BL/BL/LV	94	RT609WH/A/P	70, 84		
RT413WH/LV	78, 95	RT609WH/DO/P	84		

Topaz Limited Warranty

Topaz Lighting Corp. (hereinafter called "Topaz"), 925 Waverly Avenue, Holtsville, NY 11742, warrants to the purchaser that Topaz lamps will be free from defect in material and/or workmanship from the date of purchase for the following time periods:

Category	Warranty*
Compact Fluorescent	2 Years
LED A19 ECO:	3 Years
LED Filament:	3 Years
LED A-Shape:	5 Years
LED Globe:	5 Years
LED Indoor Reflector:	5 Years
LED Linear:	5 Years
LED Luminaire:	5 Years
LED Mini-Reflector:	5 Years
LED PAR:	5 Years
LED Plug-in Style:	5 Years
LED Post Top Light:	5 Years
LED Retrofit Unit:	5 Years
LED Surface Mount Light:	5 Years

All other lamps are covered under our Quality Policy.

LIMITED WARRANTY: Topaz Lighting Corp. warrants to the original purchaser that Topaz lamps shall be free from defects of material and workmanship for a period as stated above from the date of purchase. Topaz Lighting Corp. will, at its option, repair or replace without charge a defective lamp that has not been misused, carelessly handled or improperly installed. Repair or replacement, as stated above, shall constitute the purchaser's exclusive warranty, which does not extend to transportation, installation, labor or any other incidental or consequential charges. www.topaz-usa.com.

*Based on maximum operating hours @ 12 hours/day

This warranty is not applicable to any lamp, which is not installed and operated in accordance with the current edition of the National Electric Code (NEC), the Standards for Safety of Underwriters Laboratory, Inc. (UL), the Standards for the American National Standards Institute (ANSI) and with Topaz instructions and guidelines for the lamp. This warranty is not applicable to any lamp subjected to abnormal stresses and operating conditions. Use of occupancy sensors, dimmers or programmable systems with some lamp types may void the warranty.

Topaz reserves the right to examine all lamps prior to the determination of warranty status. All lamps must be retained for warranty claims. The warranty period starts on the date of installation. If the date of installation cannot be determined or is unknown, the warranty period will start with the date of the original purchase from Topaz.

Warranty Exclusion Clause for Products Exported:

This warranty shall be void for products that are exported outside the U.S. and its territories. The distributor, private labeler or OEM assumes all responsibility imposed by statute, regulation or law on product sold into those markets.

NO IMPLIED STATUTORY WARRANTY OF MERCHANTABILITY OR FITNESS FOR A PARTICULAR PURPOSE SHALL APPLY BEYOND THE AFOREMENTIONED WARRANTY PERIOD.

The foregoing warranty is exclusive of all other statutory, written or oral warranties, and no other warranties of any kind, statutory or otherwise, are given or herein expressed. The warranty sets forth Topaz's responsibilities regarding the lamp and claimant's exclusive remedy.

LIMITATION OF LIABILITY: Topaz will not under any circumstances, whether as a result of breach of contract, breach of warranty, tort, strict liability or otherwise, be liable for consequential, incidental, special or exemplary damages including, but not limited to, loss of profits or revenues, loss of use of lamp or any other goods or associated equipment or damage to any associated equipment, cost of capital, cost of substitute products, facilities of service, down time cost, or claims of claimant's customers. Topaz's liability on any claim of any kind for any loss or damages arising out of, resulting from or concerning any aspect of this agreement from the products or services furnished hereunder shall not exceed the price of the specific lamp or lamps which gives rise to the claim. Some states do not allow the exclusion or limitation of damages or the length of time for an implied warranty. Therefore, the limitations or exclusions of consequential or incidental damages and implied warranties may not apply to certain claimants. This warranty gives the claimant specific legal rights. The claimant may also have other rights, which vary from state to state.

QUALITY POLICY: Topaz is committed to providing excellent service and high quality products that fully meet and exceed established requirements. We are committed to continually improving the effectiveness of the overall Quality Management System. We will achieve this through the process of defining, understanding, as well as agreeing and conforming to customer requirements. Topaz proudly stands behind its motto "*Friendly Service ... Powerful Solutions.*"



Topaz is committed to providing excellent service and high quality products that fully meet and exceed established requirements. We will achieve this through the process of defining, understanding, as well as agreeing and conforming to customer requirements. Topaz proudly stands behind its motto "Friendly Service ... Powerful Solutions."

©2017 Topaz Lighting Corp. All rights reserved. All sizes and specifications are subject to change.



NY Office

925 Waverly Avenue
Holtsville, NY 11742
800.666.2852
Fax | 631.758.8026

CA Office

225 Parkside Drive
San Fernando, CA 91340
888.551.2852 or 818.838.3123
Fax | 888.690.2852 or 818.838.3102

FL Office

3850 20th Street, Ste 600
Vero Beach, FL 32960
800.338.2852
Fax | 772.778.5386

info@topaz-usa.com | www.topaz-usa.com