

2.1

Stacklights

SL Series

Stacklights—SL Series

2



Product Description

The new Eaton SL7 and SL4 stacklights provide reliable control over all key processes and machine availability. Now available in two sizes, 70 mm (SL7) and 40 mm (SL4), the new stacklights are engineered to keep you informed about potential material requirements, downtime and hazards. Modules are available in a wide selection of audible, illuminating and mounting options that are well suited to adapt to any industrial application.

Highly Modular and Versatile Line

- Easily configurable components
- Simple bayonet mounting mechanism for quick assembly
- Flexible mounting and lighting options
- Volume-adjustable alarms

Optimal Performance in Rugged Applications

- All elements have IP66 and UL Type 4/4X/13 ratings for protection against strong jets of water
- Bright and efficient LEDs with a lifespan of up to 100,000 hours
- High-performance LEDs for maximum illumination in direct sunlight
- Acoustic modules with up to 100 dB sound levels
- Operating temperatures: -22° to +140°F (-30° to +60°C)

Contents

Description

	<i>Page</i>
SL Series	
Product Overview	V7-T2-3
Component Identification—SL7	V7-T2-4
Product Selection—SL7	V7-T2-6
Component Identification—SL4	V7-T2-12
Product Selection—SL4	V7-T2-14
Accessories	V7-T2-19
Technical Data and Specifications	V7-T2-20
Dimensions	V7-T2-25

Features

- Six lens colors: red, amber, yellow, green, blue, white
- Continuous, flashing, strobe and multi-strobe lighting functions
- Mono-tone, dual-tone and multi-tone audible alarms
- LED or incandescent lighting options
- Control up to five modules on a single stack, 10 with dual-arm base
- 24V, 120 Vac and 230 Vac operating voltages

Benefits

- Simplified twist-and-lock assembly, no tools required
- Compact components reduce inventory requirements and increase flexibility
- Versatile hardware for quick installation and minimized downtime
- New slim 40 mm size is ideal for applications with constrained space
- Lean automation with SmartWire-DT connectivity
- Ideal for indoor and outdoor usage

Standards and Certifications

- UL 508—File No. E29184
- IEC/EN 60947-5-1
- CSA C22.2 No. 14-10
- CSA C22.2 No. 94-91
- CSA Class No. NKCR7



Product Overview

	SL7	SL4
Diameter	70 mm	40 mm
		
Acoustic Modules	Page V7-T2-9	Page V7-T2-16
		
Light Modules	Continuous light, LED: Page V7-T2-6 Flashing light, LED: Page V7-T2-7 Strobe light, LED: Page V7-T2-7 Continuous light, high-performance LED: Page V7-T2-8 Strobe light, high-performance LED: Page V7-T2-8 Multi-strobe light, high-performance LED: Page V7-T2-8 Continuous light, Incandescent: Page V7-T2-8	Continuous light, LED: Page V7-T2-16 Flashing light, LED: Page V7-T2-15 Strobe light, LED: Page V7-T2-15 Multi-strobe light, LED: Page V7-T2-17 Continuous light, Incandescent: Page V7-T2-17
		
		
Base Modules	Page V7-T2-10, V7-T2-11	Page V7-T2-17
Accessories	Page V7-T2-19	Page V7-T2-19

2.1

Stacklights

SL Series

Component Identification—SL7

2

Component Identification



Light Modes

	Continuous	Flashing	Strobe	Multi-Strobe
Incandescent		—	—	—
LED				

2.1

Stacklights

SL Series

Component Identification—SL4

Component Identification

2

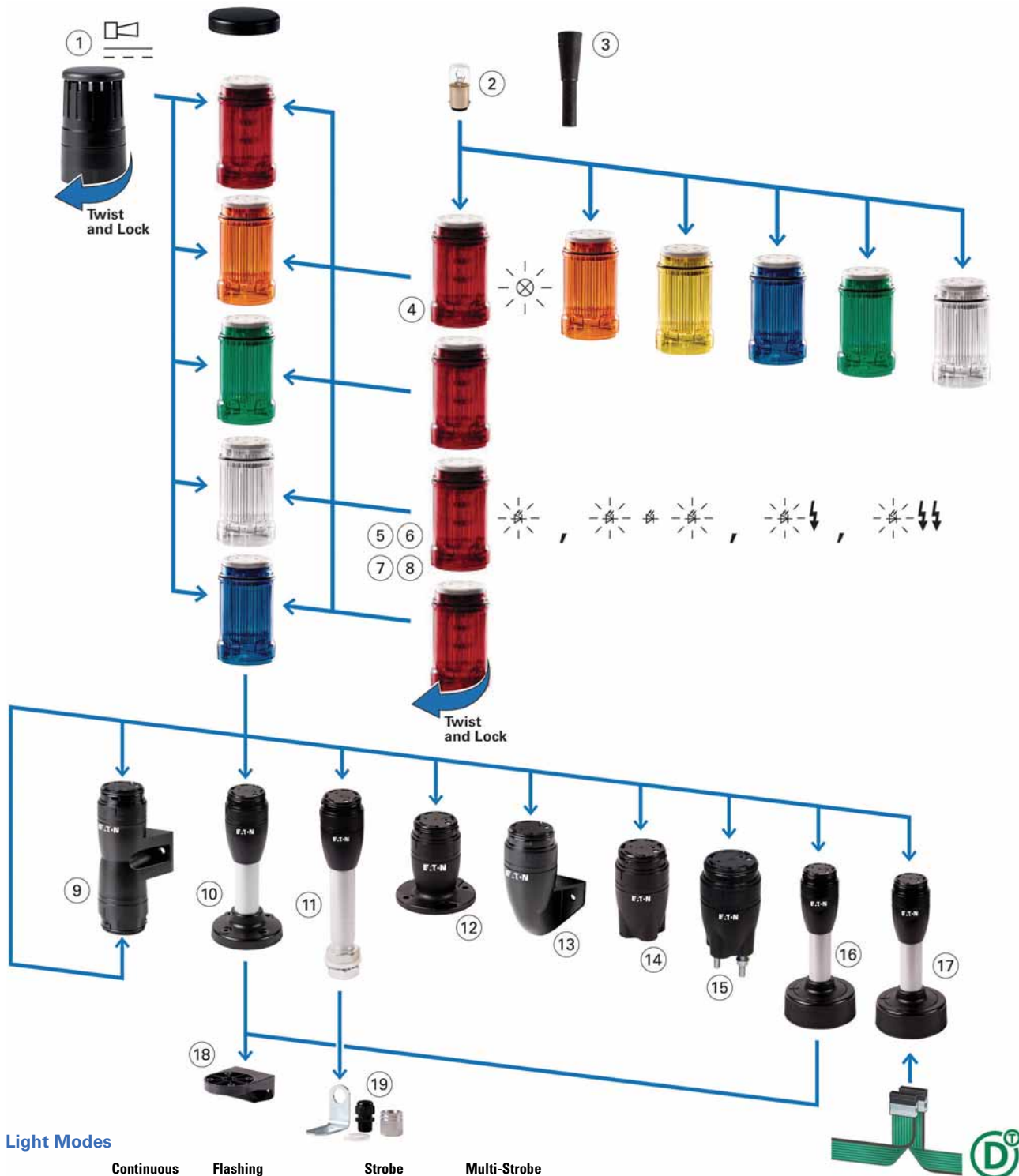

Light Modes

	Continuous	Flashing	Strobe	Multi-Strobe
Incandescent		—	—	—
LED				

2.1

Stacklights

SL Series

Product Selection—SL4

2

Complete Devices

SL4-100-L-R_



Continuous Light, LED, UL Type 4/4X/13, IP66

Rated Operational Voltage (U _e V)	Number of Modules	Color	Function	Standard Pack	Catalog Number
Base Module with Foot and 100 mm Tube					
24 Vac/Vdc	2	Red/Green		1	SL4-100-L-RG-24LED
	3	Red/Amber/Green			SL4-100-L-RAG-24LED

Light Module with LED

SL4-L_



Continuous Light, UL Type 4/4X/13, IP66

Rated Operational Voltage (U _e V)	Color	Function	Standard Pack	Catalog Number
24 Vac/Vdc	Blue		1	SL4-L24-B
	Green			SL4-L24-G
	Red			SL4-L24-R
	White			SL4-L24-W
	Yellow			SL4-L24-Y
	Amber			SL4-L24-A
110/120 Vac	Blue		1	SL4-L120-B
	Green			SL4-L120-G
	Red			SL4-L120-R
	White			SL4-L120-W
	Yellow			SL4-L120-Y
	Amber			SL4-L120-A
230/240 Vac	Blue		1	SL4-L230-B
	Green			SL4-L230-G
	Red			SL4-L230-R
	White			SL4-L230-W
	Yellow			SL4-L230-Y
	Amber			SL4-L230-A

SL4 Series**SL4 General Specifications**

Description	Specification
Standards	IEC/EN 60947-5-1
Lens color	Blue, green, red, clear, yellow, orange
Number of signal elements	Max. 5 with standard base Max. 10 with base for mounting on both sides
Mounting position	As required
Mechanical Ratings	
Mechanical shock resistance	>15g according to IEC 60068-2-27 Shock duration 11 ms Sinusoidal
Climate Conditions	
Climatic proofing	Damp heat, constant, to IEC 60068-2-78 Damp heat, cyclic, to IEC 60069-2-30
Ambient temperature	-22°F to +140°F (-30°C to +60°C)
Environmental Ratings	
IEC degree of protection	UL Type 4/4X/13, IP66 IEC/EN 60529
Protection type UL	Type 4/4X/13
Materials	
Enclosure	Polycarbonate (PC), black
Cap	Polycarbonate (PC)
Terminal Capacity	
Solid or flexible conductor	0.2–1.5 mm ²
Solid or flexible conductor, with ferrule	0.25–1.5 mm ²
Flexible with ferrule with plastic collar	0.25–0.75 mm ² AWG 24–AWG 16
Contacts	
Rated impulse withstand voltage (U _{imp})	4000 Vac
Rated insulation voltage (U _i)	250V
Overvoltage category/pollution degree	III/3

SL4 Light Module Specifications

	Unit	SL4-L...-...	SL4-BL...-...	SL4-FL...-...	SL4-FL24...-M	SL4-L...
Type of light		Continuous light	Flashing light	Strobe light	Multi-strobe light	Continuous light
Light elements		LED	LED	LED	LED	Incandescent bulb (max. 4W)
Mounting		—	—	—	—	Ba15d
Flashing/strobe frequency		—	2 Hz	1.4 Hz	1–2.6 Hz	—
Transmission angle		360°	360°	360°	360°	360°
Leakage current	A	< 0.003	< 0.003	< 0.003	< 0.003	< 0.003
Current/power consumption						
24 Vac/Vdc	A	0.022–0.033	0.028–0.036	0.035–0.065	0.048–0.068	—
110/120 Vac	A	0.030	0.030	0.10	—	—
230/240 Vac	A	0.030	0.030	0.10	—	—
Power consumption		—	—	—	—	Maximum 4W with the specified voltages
Voltage levels		24 Vac/Vdc ± 10% 110/120 Vac ± 10% 230/240 Vac ± 10%	24 Vac/Vdc ± 10% 110/120 Vac ± 10% 230/240 Vac ± 10%	24 Vac/Vdc ± 10% 110/120 Vac ± 10% 230/240 Vac ± 10%	24 Vac/Vdc ± 10%	Up to 250 Vac/Vdc
Lifespan	h	100,000	100,000	100,000	100,000	100,000
Weight	g	45	45	45	45	45

SL4 Acoustic Module Specifications

	Unit	SL4-AP...
Type of tone		Continuous or pulsed tone
Types of sound		Two versions, table of sound types
Sound setting		Internal; single-pole DIP
Sound pressure	dB	80
Sound pressure level adjustment		—
Sound pressure can be lowered to a minimum of		—
Transmission angle		360°
Current/power consumption		
24 Vac/Vdc	A	0.039
110/120 Vac	A	0.021
230/240 Vac	A	0.021
Voltage levels		24 Vac/Vdc ± 10% 110/120 Vac ± 10% 230/240 Vac ± 10%
Weight	g	43

SL4 Table of Sound Types

	Sound Type	Frequency (Hz)	Diagram	Repeat Rate	Maximum Volume at 1M (dB)
SL4-AP...	Continuous tone	Approx. 4000	—	—	80
	Pulsed tone	Approx. 4000	— — —	Approx. 2 Hz	80

2.1

Stacklights

SL Series

Approximate Dimensions in Inches (mm)

2

SL4 Series

Complete Devices

SL4-100-L-RG-24LED



SL4-100-L-RYG-24LED

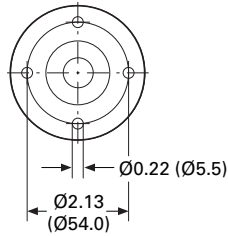
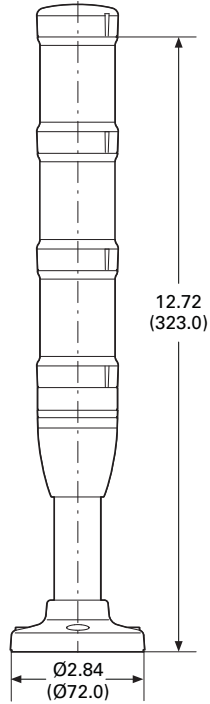

Light Modules

SL4-(B)(F)L...

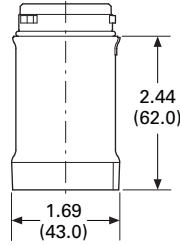

Acoustic Modules

SL4-AP...

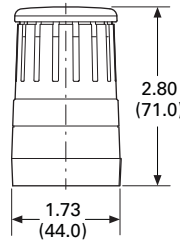

Approximate Dimensions in Inches (mm)

Basic Modules

SL4-PIB-...

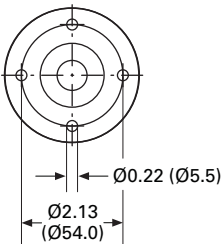
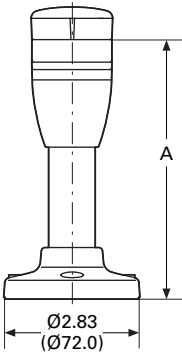

Catalog Number	A
SL4-PIB-100	3.53 (136.0)
SL4-PIB-250	11.26 (286.0)
SL4-PIB-400	17.16 (436.0)

SL4-PIB-T...

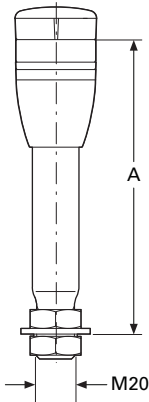

Catalog Number	A
SL4-PIB-T-100	5.90 (150.0)
SL4-PIB-T-250	11.81 (300.0)
SL4-PIB-T-400	17.72 (450.0)

SL4-PIB-D

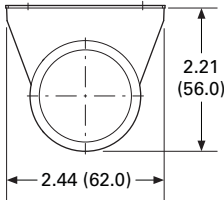
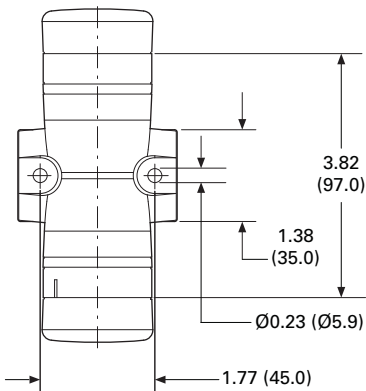

SL4-PIB-EMH

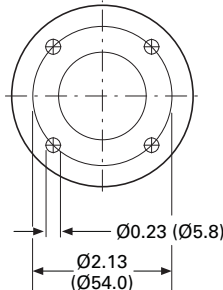
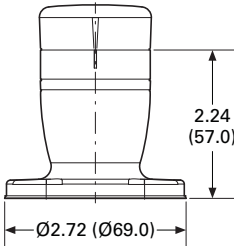

2.1

Stacklights

SL Series

Approximate Dimensions in Inches (mm)

2

SL4-PIB-FW

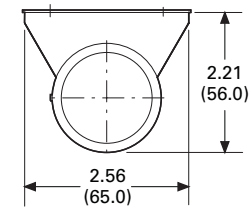
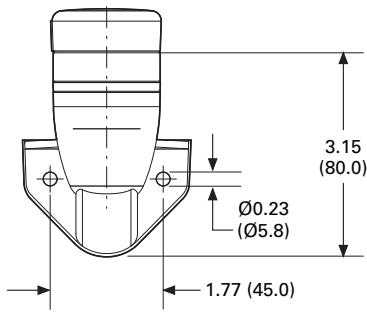

SL4-PIB-IMH

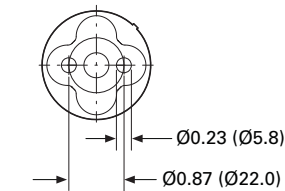
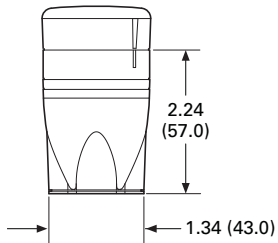

SL4-PIB-IMS

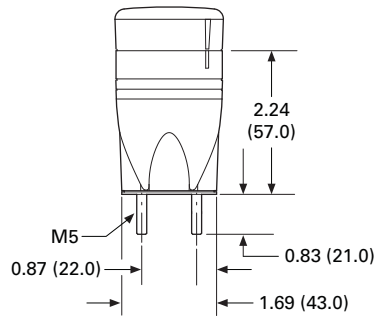

SL4-FMS-...

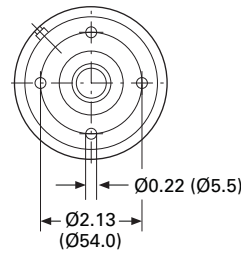
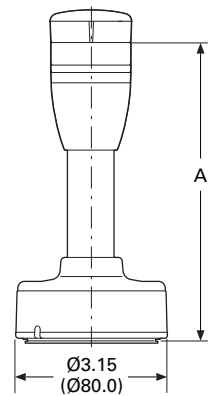

SL4-SWD^①

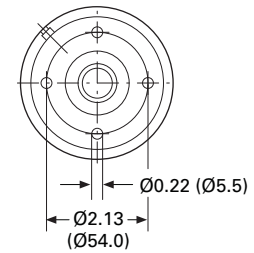
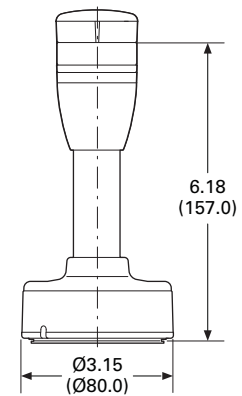

Catalog Number	A
SL4-FMS-100	6.18 (157.0)
SL4-FMS-250	12.09 (307.0)
SL4-FMS-400	17.99 (457.0)

Note

① For connecting to SmartWire-DT.

2.1

Stacklights

SL Series

Stacklights—SL Series

2



Product Description

The new Eaton SL7 and SL4 stacklights provide reliable control over all key processes and machine availability. Now available in two sizes, 70 mm (SL7) and 40 mm (SL4), the new stacklights are engineered to keep you informed about potential material requirements, downtime and hazards. Modules are available in a wide selection of audible, illuminating and mounting options that are well suited to adapt to any industrial application.

Highly Modular and Versatile Line

- Easily configurable components
- Simple bayonet mounting mechanism for quick assembly
- Flexible mounting and lighting options
- Volume-adjustable alarms

Optimal Performance in Rugged Applications

- All elements have IP66 and UL Type 4/4X/13 ratings for protection against strong jets of water
- Bright and efficient LEDs with a lifespan of up to 100,000 hours
- High-performance LEDs for maximum illumination in direct sunlight
- Acoustic modules with up to 100 dB sound levels
- Operating temperatures: -22° to +140°F (-30° to +60°C)

Contents

Description

	<i>Page</i>
SL Series	
Product Overview	V7-T2-3
Component Identification—SL7	V7-T2-4
Product Selection—SL7	V7-T2-6
Component Identification—SL4	V7-T2-12
Product Selection—SL4	V7-T2-14
Accessories	V7-T2-19
Technical Data and Specifications	V7-T2-20
Dimensions	V7-T2-25

Features

- Six lens colors: red, amber, yellow, green, blue, white
- Continuous, flashing, strobe and multi-strobe lighting functions
- Mono-tone, dual-tone and multi-tone audible alarms
- LED or incandescent lighting options
- Control up to five modules on a single stack, 10 with dual-arm base
- 24V, 120 Vac and 230 Vac operating voltages

Benefits

- Simplified twist-and-lock assembly, no tools required
- Compact components reduce inventory requirements and increase flexibility
- Versatile hardware for quick installation and minimized downtime
- New slim 40 mm size is ideal for applications with constrained space
- Lean automation with SmartWire-DT connectivity
- Ideal for indoor and outdoor usage

Standards and Certifications

- UL 508—File No. E29184
- IEC/EN 60947-5-1
- CSA C22.2 No. 14-10
- CSA C22.2 No. 94-91
- CSA Class No. NKCR7



Product Overview

	SL7	SL4
Diameter	70 mm	40 mm
		
Acoustic Modules	Page V7-T2-9	Page V7-T2-16
		
Light Modules	Continuous light, LED: Page V7-T2-6 Flashing light, LED: Page V7-T2-7 Strobe light, LED: Page V7-T2-7 Continuous light, high-performance LED: Page V7-T2-8 Strobe light, high-performance LED: Page V7-T2-8 Multi-strobe light, high-performance LED: Page V7-T2-8 Continuous light, Incandescent: Page V7-T2-8	Continuous light, LED: Page V7-T2-16 Flashing light, LED: Page V7-T2-15 Strobe light, LED: Page V7-T2-15 Multi-strobe light, LED: Page V7-T2-17 Continuous light, Incandescent: Page V7-T2-17
		
		
Base Modules	Page V7-T2-10, V7-T2-11	Page V7-T2-17
Accessories	Page V7-T2-19	Page V7-T2-19

2.1

Stacklights

SL Series

Component Identification—SL7

2

Component Identification



Light Modes

	Continuous	Flashing	Strobe	Multi-Strobe
Incandescent		—	—	—
LED				

2.1

Stacklights

SL Series

Component Identification—SL4

Component Identification

2

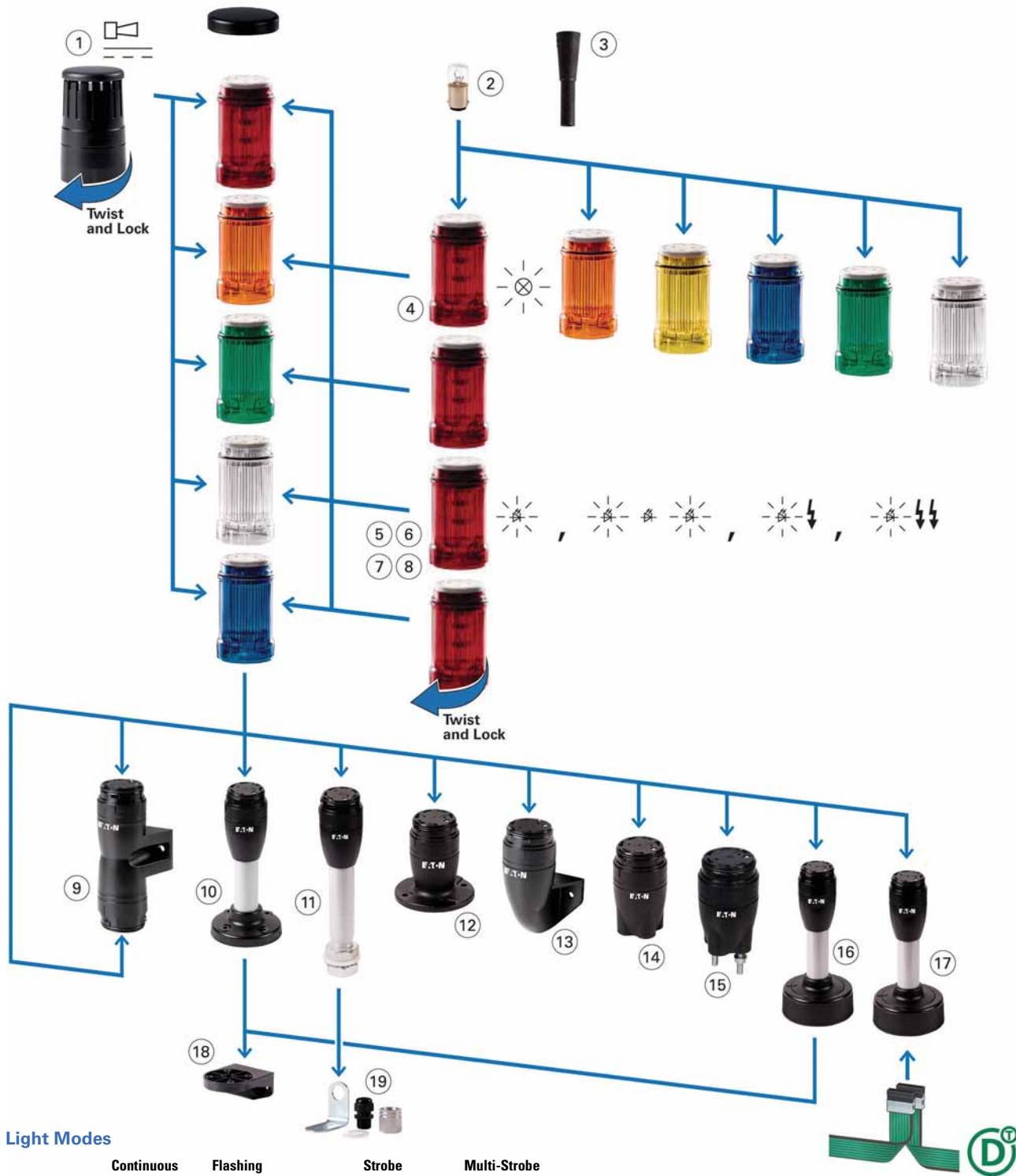

Light Modes

	Continuous	Flashing	Strobe	Multi-Strobe
Incandescent		—	—	—
LED				

2.1

Stacklights

SL Series

Product Selection—SL4

2

Complete Devices

SL4-100-L-R_



Continuous Light, LED, UL Type 4/4X/13, IP66

Rated Operational Voltage (U _e V)	Number of Modules	Color	Function	Standard Pack	Catalog Number
Base Module with Foot and 100 mm Tube					
24 Vac/Vdc	2	Red/Green		1	SL4-100-L-RG-24LED
	3	Red/Amber/Green			SL4-100-L-RAG-24LED

Light Module with LED

SL4-L_



Continuous Light, UL Type 4/4X/13, IP66

Rated Operational Voltage (U _e V)	Color	Function	Standard Pack	Catalog Number
24 Vac/Vdc	Blue		1	SL4-L24-B
	Green			SL4-L24-G
	Red			SL4-L24-R
	White			SL4-L24-W
	Yellow			SL4-L24-Y
	Amber			SL4-L24-A
110/120 Vac	Blue		1	SL4-L120-B
	Green			SL4-L120-G
	Red			SL4-L120-R
	White			SL4-L120-W
	Yellow			SL4-L120-Y
	Amber			SL4-L120-A
230/240 Vac	Blue		1	SL4-L230-B
	Green			SL4-L230-G
	Red			SL4-L230-R
	White			SL4-L230-W
	Yellow			SL4-L230-Y
	Amber			SL4-L230-A

SL4 Series**SL4 General Specifications**

Description	Specification
Standards	IEC/EN 60947-5-1
Lens color	Blue, green, red, clear, yellow, orange
Number of signal elements	Max. 5 with standard base Max. 10 with base for mounting on both sides
Mounting position	As required
Mechanical Ratings	
Mechanical shock resistance	>15g according to IEC 60068-2-27 Shock duration 11 ms Sinusoidal
Climate Conditions	
Climatic proofing	Damp heat, constant, to IEC 60068-2-78 Damp heat, cyclic, to IEC 60069-2-30
Ambient temperature	-22°F to +140°F (-30°C to +60°C)
Environmental Ratings	
IEC degree of protection	UL Type 4/4X/13, IP66 IEC/EN 60529
Protection type UL	Type 4/4X/13
Materials	
Enclosure	Polycarbonate (PC), black
Cap	Polycarbonate (PC)
Terminal Capacity	
Solid or flexible conductor	0.2–1.5 mm ²
Solid or flexible conductor, with ferrule	0.25–1.5 mm ²
Flexible with ferrule with plastic collar	0.25–0.75 mm ² AWG 24–AWG 16
Contacts	
Rated impulse withstand voltage (U _{imp})	4000 Vac
Rated insulation voltage (U _i)	250V
Overvoltage category/pollution degree	III/3

SL4 Light Module Specifications

	Unit	SL4-L...-...	SL4-BL...-...	SL4-FL...-...	SL4-FL24...-M	SL4-L...
Type of light		Continuous light	Flashing light	Strobe light	Multi-strobe light	Continuous light
Light elements		LED	LED	LED	LED	Incandescent bulb (max. 4W)
Mounting		—	—	—	—	Ba15d
Flashing/strobe frequency		—	2 Hz	1.4 Hz	1–2.6 Hz	—
Transmission angle		360°	360°	360°	360°	360°
Leakage current	A	< 0.003	< 0.003	< 0.003	< 0.003	< 0.003
Current/power consumption						
24 Vac/Vdc	A	0.022–0.033	0.028–0.036	0.035–0.065	0.048–0.068	—
110/120 Vac	A	0.030	0.030	0.10	—	—
230/240 Vac	A	0.030	0.030	0.10	—	—
Power consumption		—	—	—	—	Maximum 4W with the specified voltages
Voltage levels		24 Vac/Vdc ± 10% 110/120 Vac ± 10% 230/240 Vac ± 10%	24 Vac/Vdc ± 10% 110/120 Vac ± 10% 230/240 Vac ± 10%	24 Vac/Vdc ± 10% 110/120 Vac ± 10% 230/240 Vac ± 10%	24 Vac/Vdc ± 10%	Up to 250 Vac/Vdc
Lifespan	h	100,000	100,000	100,000	100,000	100,000
Weight	g	45	45	45	45	45

SL4 Acoustic Module Specifications

	Unit	SL4-AP...
Type of tone		Continuous or pulsed tone
Types of sound		Two versions, table of sound types
Sound setting		Internal; single-pole DIP
Sound pressure	dB	80
Sound pressure level adjustment		—
Sound pressure can be lowered to a minimum of		—
Transmission angle		360°
Current/power consumption		
24 Vac/Vdc	A	0.039
110/120 Vac	A	0.021
230/240 Vac	A	0.021
Voltage levels		24 Vac/Vdc ± 10% 110/120 Vac ± 10% 230/240 Vac ± 10%
Weight	g	43

SL4 Table of Sound Types

	Sound Type	Frequency (Hz)	Diagram	Repeat Rate	Maximum Volume at 1M (dB)
SL4-AP...	Continuous tone	Approx. 4000	—————	—	80
	Pulsed tone	Approx. 4000	— — —	Approx. 2 Hz	80

2.1

Stacklights

SL Series

Approximate Dimensions in Inches (mm)

2

SL4 Series

Complete Devices

SL4-100-L-RG-24LED

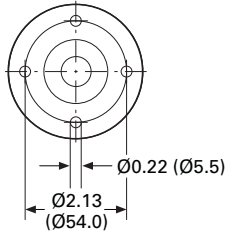
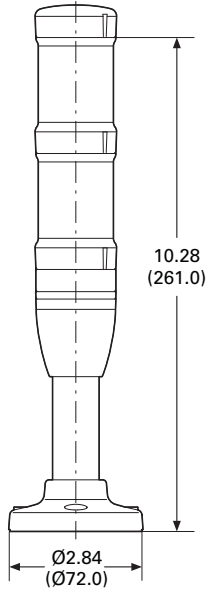

SL4-100-L-RYG-24LED

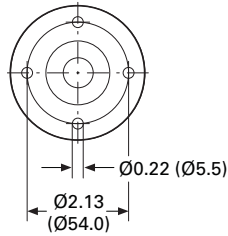
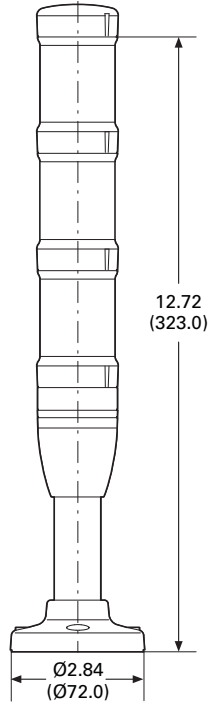

Light Modules

SL4-(B)(F)L...

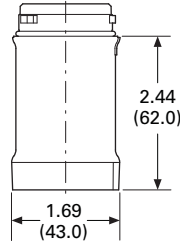

Acoustic Modules

SL4-AP...

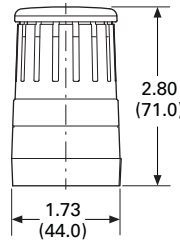

Approximate Dimensions in Inches (mm)

Basic Modules

SL4-PIB-...

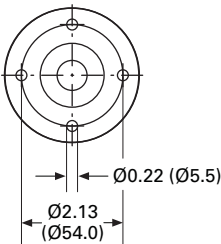
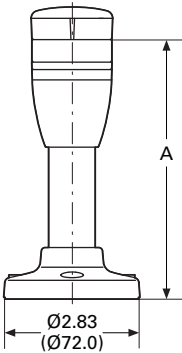

Catalog Number	A
SL4-PIB-100	3.53 (136.0)
SL4-PIB-250	11.26 (286.0)
SL4-PIB-400	17.16 (436.0)

SL4-PIB-T...

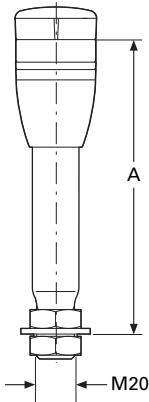

Catalog Number	A
SL4-PIB-T-100	5.90 (150.0)
SL4-PIB-T-250	11.81 (300.0)
SL4-PIB-T-400	17.72 (450.0)

SL4-PIB-D

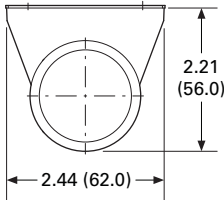
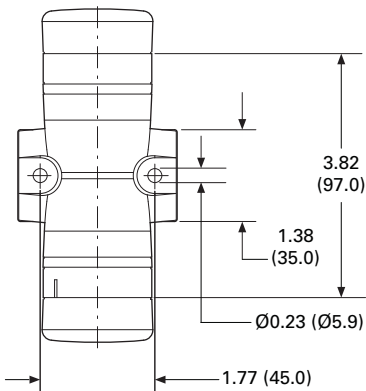

SL4-PIB-EMH

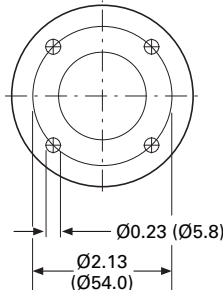
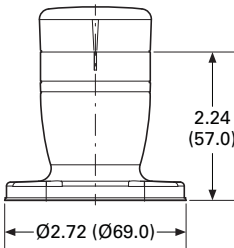

2.1

Stacklights

SL Series

Approximate Dimensions in Inches (mm)

2

SL4-PIB-FW

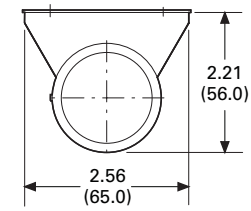
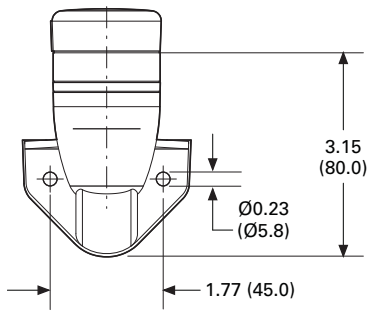

SL4-PIB-IMH

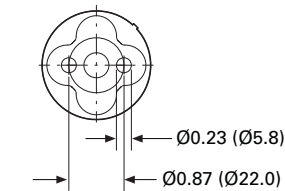
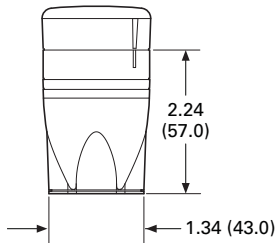

SL4-PIB-IMS

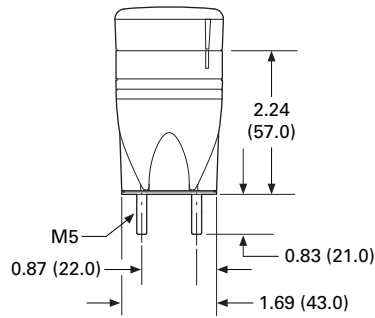

SL4-FMS-...

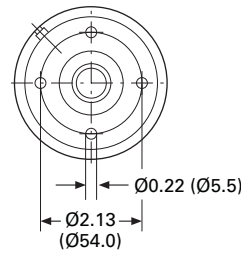
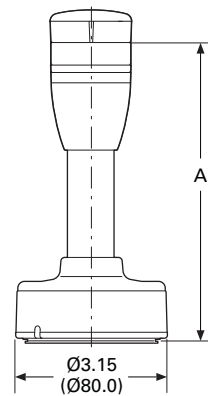

SL4-SWD^①

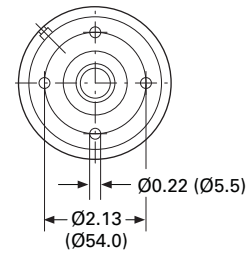
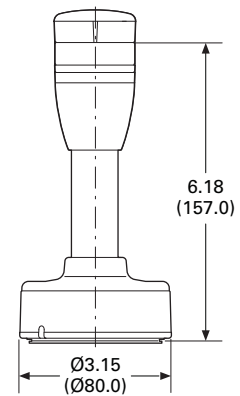

Catalog Number	A
SL4-FMS-100	6.18 (157.0)
SL4-FMS-250	12.09 (307.0)
SL4-FMS-400	17.99 (457.0)

Note

① For connecting to SmartWire-DT.