

2.1

Stacklights

SL Series

Stacklights—SL Series

2



Product Description

The new Eaton SL7 and SL4 stacklights provide reliable control over all key processes and machine availability. Now available in two sizes, 70 mm (SL7) and 40 mm (SL4), the new stacklights are engineered to keep you informed about potential material requirements, downtime and hazards. Modules are available in a wide selection of audible, illuminating and mounting options that are well suited to adapt to any industrial application.

Highly Modular and Versatile Line

- Easily configurable components
- Simple bayonet mounting mechanism for quick assembly
- Flexible mounting and lighting options
- Volume-adjustable alarms

Optimal Performance in Rugged Applications

- All elements have IP66 and UL Type 4/4X/13 ratings for protection against strong jets of water
- Bright and efficient LEDs with a lifespan of up to 100,000 hours
- High-performance LEDs for maximum illumination in direct sunlight
- Acoustic modules with up to 100 dB sound levels
- Operating temperatures: -22° to +140°F (-30° to +60°C)

Contents

Description

	<i>Page</i>
SL Series	
Product Overview	V7-T2-3
Component Identification—SL7	V7-T2-4
Product Selection—SL7	V7-T2-6
Component Identification—SL4	V7-T2-12
Product Selection—SL4	V7-T2-14
Accessories	V7-T2-19
Technical Data and Specifications	V7-T2-20
Dimensions	V7-T2-25

Features

- Six lens colors: red, amber, yellow, green, blue, white
- Continuous, flashing, strobe and multi-strobe lighting functions
- Mono-tone, dual-tone and multi-tone audible alarms
- LED or incandescent lighting options
- Control up to five modules on a single stack, 10 with dual-arm base
- 24V, 120 Vac and 230 Vac operating voltages

Benefits

- Simplified twist-and-lock assembly, no tools required
- Compact components reduce inventory requirements and increase flexibility
- Versatile hardware for quick installation and minimized downtime
- New slim 40 mm size is ideal for applications with constrained space
- Lean automation with SmartWire-DT connectivity
- Ideal for indoor and outdoor usage

Standards and Certifications

- UL 508—File No. E29184
- IEC/EN 60947-5-1
- CSA C22.2 No. 14-10
- CSA C22.2 No. 94-91
- CSA Class No. NKCR7



Product Overview

	SL7	SL4
Diameter	70 mm	40 mm
		
Acoustic Modules	Page V7-T2-9	Page V7-T2-16
		
Light Modules	Continuous light, LED: Page V7-T2-6 Flashing light, LED: Page V7-T2-7 Strobe light, LED: Page V7-T2-7 Continuous light, high-performance LED: Page V7-T2-8 Strobe light, high-performance LED: Page V7-T2-8 Multi-strobe light, high-performance LED: Page V7-T2-8 Continuous light, Incandescent: Page V7-T2-8	Continuous light, LED: Page V7-T2-16 Flashing light, LED: Page V7-T2-15 Strobe light, LED: Page V7-T2-15 Multi-strobe light, LED: Page V7-T2-17 Continuous light, Incandescent: Page V7-T2-17
		
		
Base Modules	Page V7-T2-10, V7-T2-11	Page V7-T2-17
Accessories	Page V7-T2-19	Page V7-T2-19

2.1

Stacklights

SL Series

Component Identification—SL7

2

Component Identification

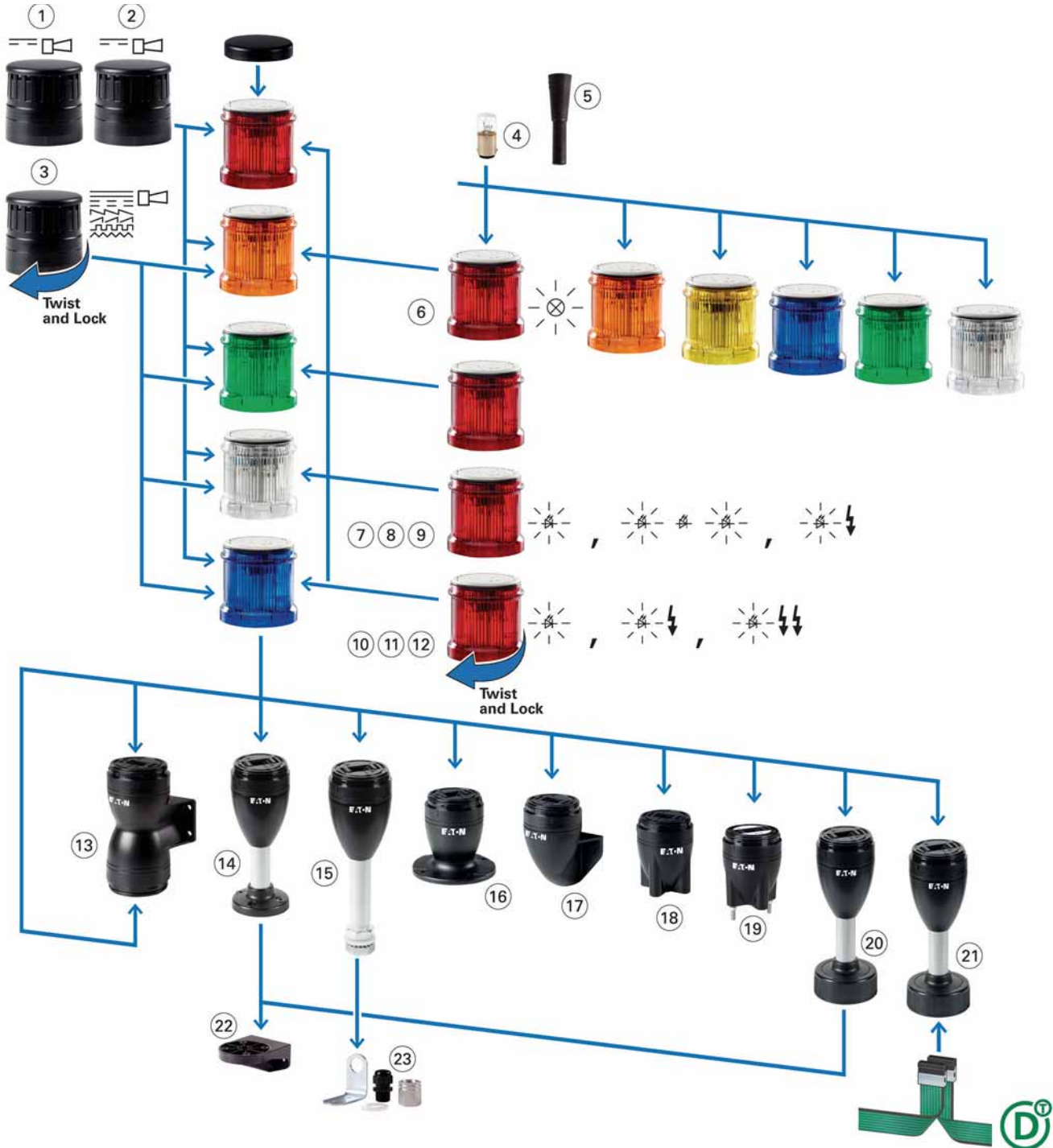



Light Modes

	Continuous	Flashing	Strobe	Multi-Strobe
Incandescent		—	—	—
LED				

SL7 Base Modules, continued

For Horizontal Mounting—Includes Cover, Maximum 5 Modules, continued

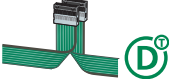
	Description	Tube Length	Color	Standard Pack	For use with ...	Catalog Number
SL7-FMS_ 	Base with base adapter for slipping onto place (rapid mounting and wiring system) Screw terminals	100 mm	Black	1	SL7-L-...	SL7-FMS-100
		250 mm	aluminum color tube		SL7-BL-...	SL7-FMS-250
		400 mm			SL7-FL-... SL7-AP-...	SL7-FMS-400
SL7-SWD  	Base with base adapter for slipping onto place (rapid mounting and wiring system) Blade terminal SWD4-8MF2 Maximum 0.3A per module External power supply connectable (24 Vdc) Configurable with SWD-Assist (planning and ordering help)	100 mm	—	1	SL7-L-... SL7-BL-... SL7-FL-... SL7-AP-...	SL7-SWD

SL7-CB-FW For Vertical Mounting—Includes Cover, Maximum 5 Modules

	Description	Color	Standard Pack	For use with ...	Catalog Number
	Vertical base with bracket Spring-loaded terminals	Black	1	SL7-L-... SL7-BL-... SL7-FL-... SL7-AP-...	SL7-CB-FW

SL7-CB-D For Mounting on Both Sides—Includes Cover, Maximum 2 x 5 Modules

	Description	Color	Standard Pack	For use with ...	Catalog Number
	Base with external fixing holes Spring-loaded terminals	Black	1	SL7-L-... SL7-BL-... SL7-FL-... SL7-AP-...	SL7-CB-D

Technical Data and Specifications

2

SL7 Series

SL7 General Specifications

Description	Specification
Standards	IEC/EN 60947-5-1
Lens color	Blue, green, red, clear, yellow, amber
Number of signal elements	Max. 5 with standard base Max. 10 with base for mounting on both sides
Mechanical Ratings	
Shock (IEC 68-2-27)	11 ms, 15g
Vibration (IEC 68-2-6)	20 sweeps 10–150 Hz, 1g
Climate Conditions	
Climatic proofing	Damp heat, constant, to IEC 60068-2-78 Damp heat, cyclic, to IEC 60069-2-30
Operating temperature	–22° to +140°F (–30° to +60°C)
Storage temperature	–22° to +185°F (–30° to +85°C)
Environmental Ratings	
IEC degree of protection	UL Type 4/4X/13, IP66 IEC/EN 60529
Protection type UL	Type 4/4X/13
Materials	
Cover	Polycarbonate
Lenses	Polycarbonate
Stacklight base	Polycarbonate
Tubes	Aluminum
Terminal Capacity	
Solid or flexible conductor	0.13–2.5 mm ²
Flexible with ferrule with plastic collar	0.25–1.5 mm ² AWG 24–AWG 14
Contacts	
Rated impulse withstand voltage (U _{imp})	4000 Vac
Rated insulation voltage (U _i)	250V
Overvoltage category/pollution degree	III/3

SL7 Light Module Specifications

	Unit	SL7-L-...-...	SL7-BL-...-...	SL7-FL-...-...	SL7-L24-...-HP	SL7-FL24-...-HP	SL7-FL24-...-HPM	SL7-L-...
Type of light		Continuous light	Flashing light	Strobe light	Continuous light	Strobe light	Multi-strobe light	Continuous light
Light elements		LED	LED	LED	High-performance LED	High-performance LED	High-performance LED	Incandescent bulb (max. 7W)
Mounting		—	—	—	—	—	—	Ba15d
Flashing/strobe frequency		—	2 Hz	1.4 Hz	—	1.4 Hz	1–2.6 Hz	—
Transmission angle		360°	360°	360°	360°	360°	360°	360°
Leakage current	A	<0.003	<0.003	<0.003	<0.003	<0.003	<0.003	<0.003
Current-/power consumption								
24 Vac/Vdc	A	0.049–0.054	0.058	0.130–0.135	0.170–0.200	0.260–0.265	0.260–0.265	—
110/120 Vac	A	0.028–0.031	0.028–0.030	0.010	—	—	—	—
230/240 Vac	A	0.027–0.028	0.030–0.031	0.010	—	—	—	—
Power consumption		—	—	—	—	—	—	Max. 7W with the specified voltages
Voltage levels		24 Vac/Vdc ± 10% 110/120 Vac ± 10% 230/240 Vac ± 10%	24 Vac/Vdc ± 10% 110/120 Vac ± 10% 230/240 Vac ± 10%	24 Vac/Vdc ± 10% 110/120 Vac ± 10% 230/240 Vac ± 10%	18–30 Vdc/ 18–26 Vac	18–30 Vdc/ 18–26 Vac	18–30 Vdc/ 18–26 Vac	Up to 250 Vac/Vdc
Lifespan	h	100,000	100,000	100,000	50,000	50,000	50,000	3000
Weight	g	80	80	80	80	80	80	80

SL7 Acoustic Module Specifications

	Unit	SL7-AP...	SL7-AP...-E	SL7-AP...-M
Type of tone		Continuous or pulsed tone	Continuous or pulsed tone	Continuous or pulsed tone Eight types of sound
Types of sound		Two versions, table of sound types	Two versions, table of sound types	Eight versions, table of sound types
Sound setting		Internal; single-pole DIP	Can be externally actuated	Internal; three-pole DIP
Sound pressure	dB	Max.: 100 Min.: 88	Max.: 100 Min.: 88	Max.: 100 Min.: 88
Sound pressure level adjustment		Built-in, potentiometer	Built-in, potentiometer	Built-in, potentiometer
Transmission angle		360°	360°	360°
Current-/power consumption				
24 Vac/Vdc	A	0.092	0.092	0.115
110/120 Vac	A	0.041	0.041	0.045
230/240 Vac	A	0.043	0.043	0.043
Voltage levels		24 Vac/Vdc ± 10% 110/120 Vac ± 10% 230/240 Vac ± 10%	24 Vac/Vdc ± 10% 110/120 Vac ± 10% 230/240 Vac ± 10%	24 Vac/Vdc ± 10% 110/120 Vac ± 10% 230/240 Vac ± 10%
Weight	g	102	102	102

SL7 Table of Sound Types

	Sound Type	Frequency (Hz)	Diagram	Repeat Rate	DIP Switch Position	Maximum Volume at 1M (dB)
SL7-AP...	Continuous tone	Approx. 2800		—	—	100
	Pulsed tone	Approx. 2800		Approx. 2 Hz	—	100
SL7-AP...-E	Continuous tone	Approx. 2800		—	—	100
	Pulsed tone	Approx. 2800		Approx. 2 Hz	—	100
SL7-AP...-M	Continuous tone	2700		—	ON	Tone 01 100
	Continuous tone	1350		—	ON	Tone 02 100
	Pulsed tone	2700		250 ms on, 250 ms off	ON	Tone 03 100
	Pulsed tone	1350		250 ms on, 250 ms off	ON	Tone 04 100
	Falling	1200–500		1 Hz	ON	Tone 05 98
	Rising	500–1200		Rising 3s, 0.5s off	ON	Tone 06 98
	Alternating	800–1000		2 Hz	ON	Tone 07 94
	rising/falling	500–1500		10 Hz	ON	Tone 08 94

Dimensions

Approximate Dimensions in Inches (mm)

SL7 Series

Complete Devices

SL7-100-L-RG-24LED

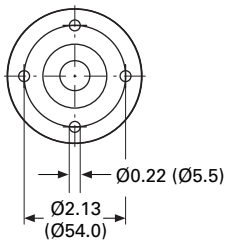
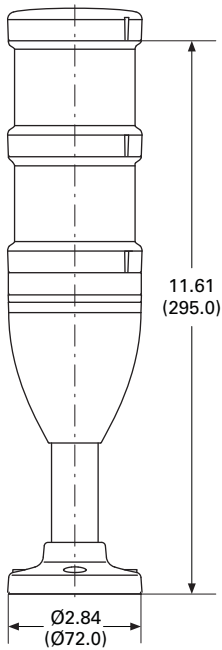

SL7-100-L-RYG-24LED

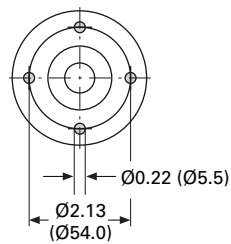
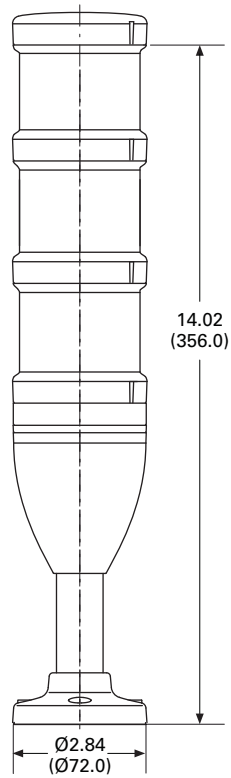

Light Modules

SL7-(B)(F)L...

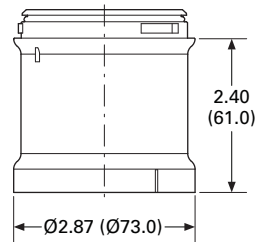

Acoustic Modules

SL7-AP...

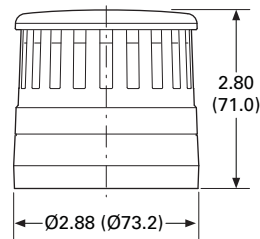

2.1

Stacklights

SL Series

Approximate Dimensions in Inches (mm)

2

Basic Modules

SL7-CB-...

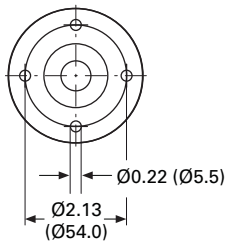
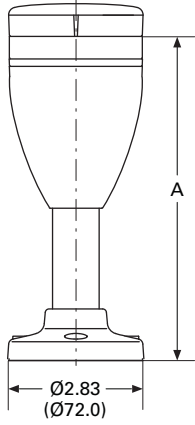

Catalog Number	A
SL7-CB-100	6.73 (171.0)
SL7-CB-250	12.64 (321.0)
SL7-CB-400	18.54 (471.0)

SL7-CB-T...

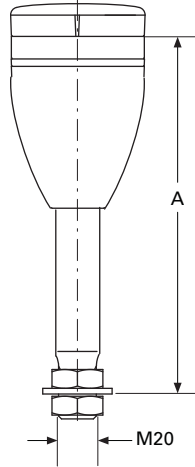

Catalog Number	A
SL7-CB-T-100	7.48 (190.0)
SL7-CB-T-250	13.38 (340.0)
SL7-CB-T-400	19.29 (490.0)

SL7-CB-D

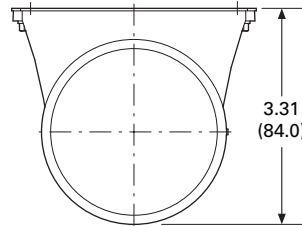
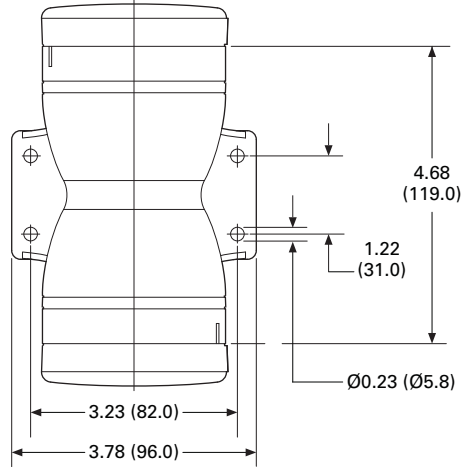

SL7-CB-EMH

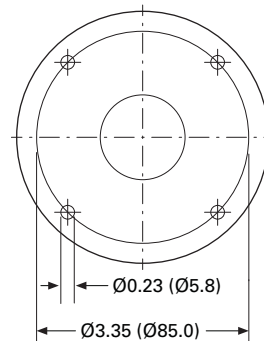
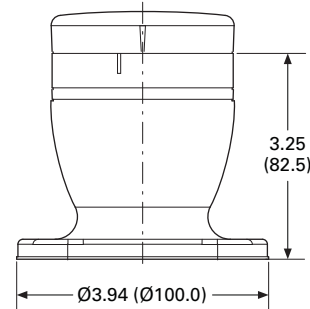

Approximate Dimensions in Inches (mm)

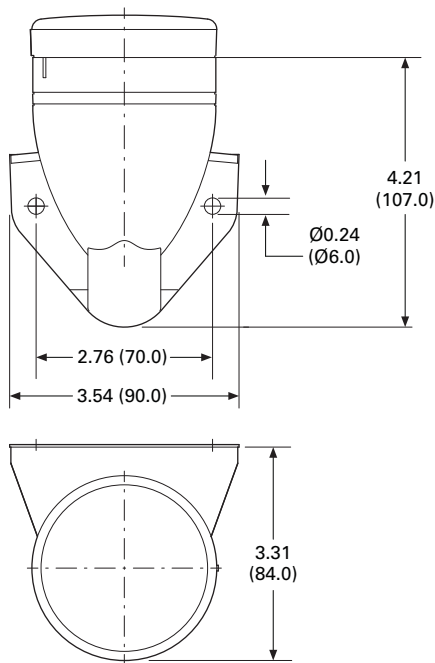
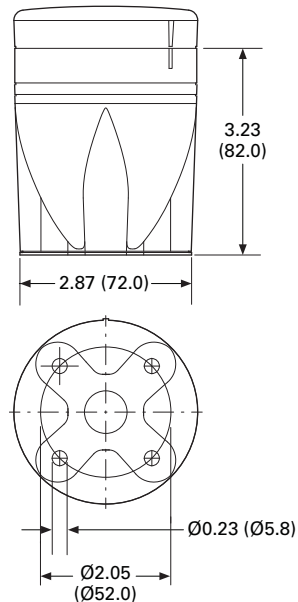
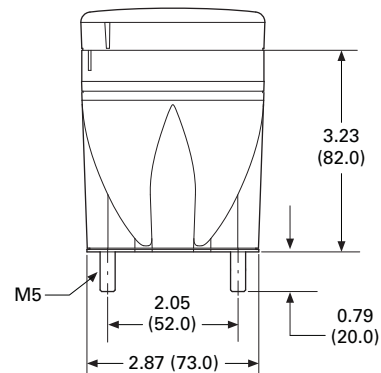
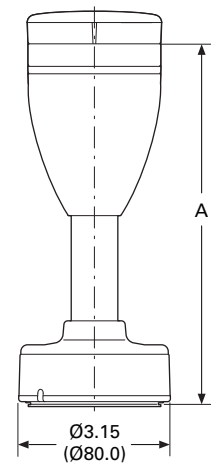
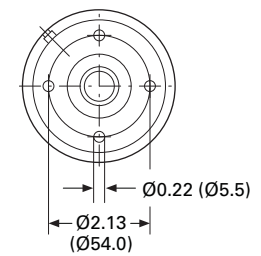
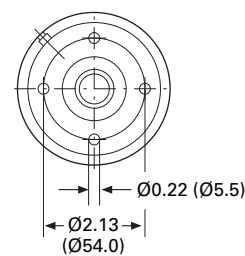
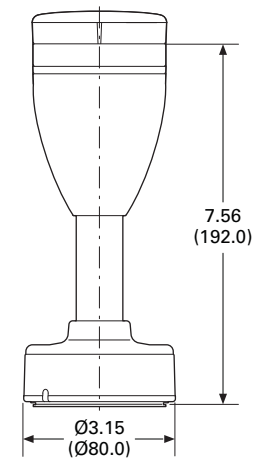
SL7-CB-FW**SL7-CB-IMH****SL7-CB-IMS****SL7-FMS-...****SL7-SWD ①**

Catalog Number	A
SL7-FMS-100	7.55 (192.0)
SL7-FMS-250	13.46 (342.0)
SL7-FMS-400	19.37 (192.0)

Note

① For connecting to SmartWire-DT.

2.1

Stacklights

SL Series

Stacklights—SL Series

2



Product Description

The new Eaton SL7 and SL4 stacklights provide reliable control over all key processes and machine availability. Now available in two sizes, 70 mm (SL7) and 40 mm (SL4), the new stacklights are engineered to keep you informed about potential material requirements, downtime and hazards. Modules are available in a wide selection of audible, illuminating and mounting options that are well suited to adapt to any industrial application.

Highly Modular and Versatile Line

- Easily configurable components
- Simple bayonet mounting mechanism for quick assembly
- Flexible mounting and lighting options
- Volume-adjustable alarms

Optimal Performance in Rugged Applications

- All elements have IP66 and UL Type 4/4X/13 ratings for protection against strong jets of water
- Bright and efficient LEDs with a lifespan of up to 100,000 hours
- High-performance LEDs for maximum illumination in direct sunlight
- Acoustic modules with up to 100 dB sound levels
- Operating temperatures: -22° to +140°F (-30° to +60°C)

Contents

Description

	<i>Page</i>
SL Series	
Product Overview	V7-T2-3
Component Identification—SL7	V7-T2-4
Product Selection—SL7	V7-T2-6
Component Identification—SL4	V7-T2-12
Product Selection—SL4	V7-T2-14
Accessories	V7-T2-19
Technical Data and Specifications	V7-T2-20
Dimensions	V7-T2-25

Features

- Six lens colors: red, amber, yellow, green, blue, white
- Continuous, flashing, strobe and multi-strobe lighting functions
- Mono-tone, dual-tone and multi-tone audible alarms
- LED or incandescent lighting options
- Control up to five modules on a single stack, 10 with dual-arm base
- 24V, 120 Vac and 230 Vac operating voltages

Benefits

- Simplified twist-and-lock assembly, no tools required
- Compact components reduce inventory requirements and increase flexibility
- Versatile hardware for quick installation and minimized downtime
- New slim 40 mm size is ideal for applications with constrained space
- Lean automation with SmartWire-DT connectivity
- Ideal for indoor and outdoor usage

Standards and Certifications

- UL 508—File No. E29184
- IEC/EN 60947-5-1
- CSA C22.2 No. 14-10
- CSA C22.2 No. 94-91
- CSA Class No. NKCR7



Product Overview

	SL7	SL4
Diameter	70 mm	40 mm
		
Acoustic Modules	Page V7-T2-9	Page V7-T2-16
		
Light Modules	Continuous light, LED: Page V7-T2-6 Flashing light, LED: Page V7-T2-7 Strobe light, LED: Page V7-T2-7 Continuous light, high-performance LED: Page V7-T2-8 Strobe light, high-performance LED: Page V7-T2-8 Multi-strobe light, high-performance LED: Page V7-T2-8 Continuous light, Incandescent: Page V7-T2-8	Continuous light, LED: Page V7-T2-16 Flashing light, LED: Page V7-T2-15 Strobe light, LED: Page V7-T2-15 Multi-strobe light, LED: Page V7-T2-17 Continuous light, Incandescent: Page V7-T2-17
		
		
Base Modules	Page V7-T2-10, V7-T2-11	Page V7-T2-17
Accessories	Page V7-T2-19	Page V7-T2-19

2.1

Stacklights

SL Series

Component Identification—SL7

2

Component Identification

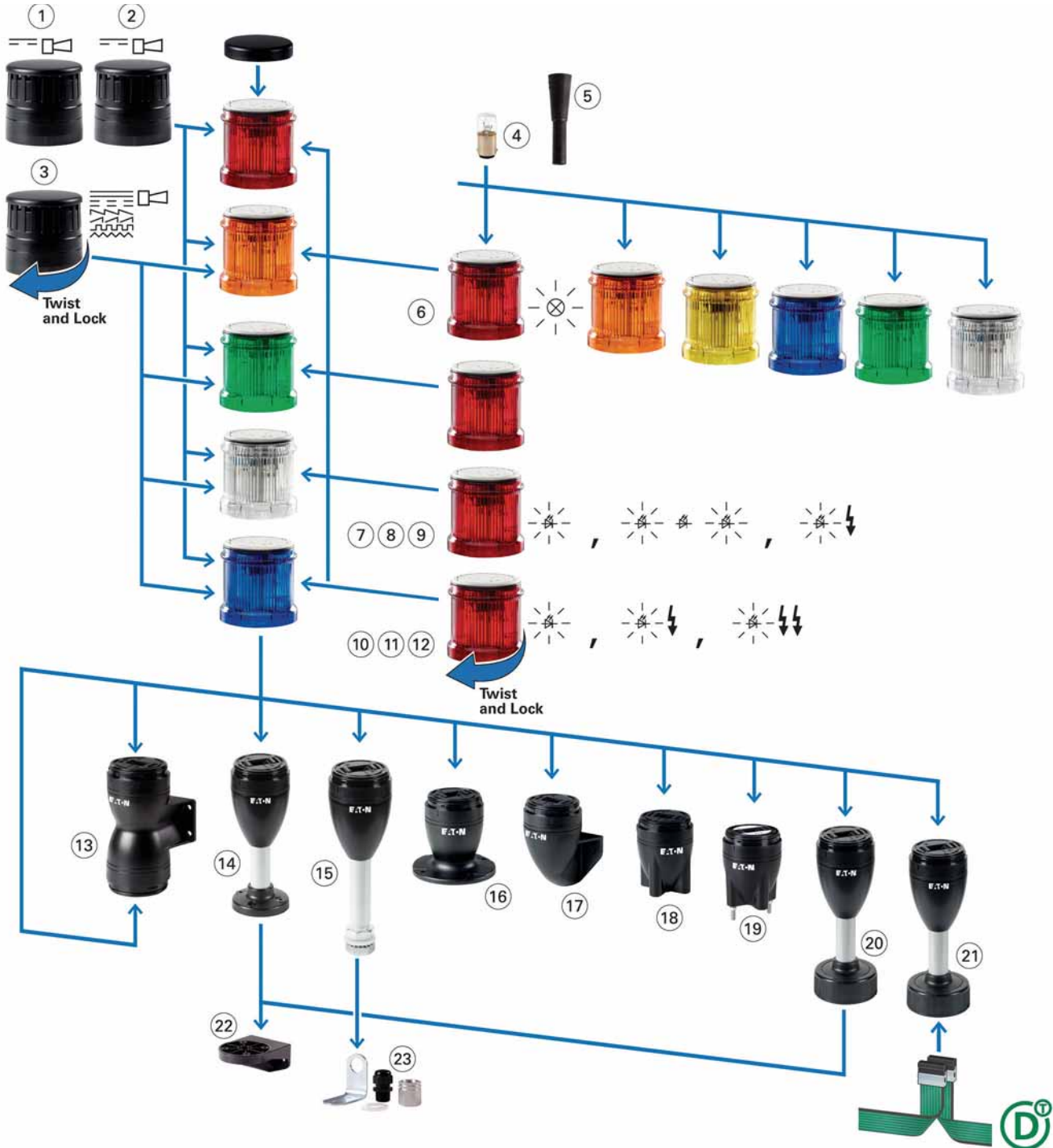



Light Modes

	Continuous	Flashing	Strobe	Multi-Strobe
Incandescent		—	—	—
LED				

SL7 Base Modules, continued

For Horizontal Mounting—Includes Cover, Maximum 5 Modules, continued

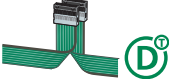
	Description	Tube Length	Color	Standard Pack	For use with ...	Catalog Number
SL7-FMS_ 	Base with base adapter for slipping onto place (rapid mounting and wiring system) Screw terminals	100 mm	Black	1	SL7-L-...	SL7-FMS-100
		250 mm	aluminum		SL7-BL-...	SL7-FMS-250
		400 mm	color tube		SL7-FL-... SL7-AP-...	SL7-FMS-400
SL7-SWD  	Base with base adapter for slipping onto place (rapid mounting and wiring system) Blade terminal SWD4-8MF2 Maximum 0.3A per module External power supply connectable (24 Vdc) Configurable with SWD-Assist (planning and ordering help)	100 mm	—	1	SL7-L-... SL7-BL-... SL7-FL-... SL7-AP-...	SL7-SWD

For Vertical Mounting—Includes Cover, Maximum 5 Modules

	Description	Color	Standard Pack	For use with ...	Catalog Number
SL7-CB-FW 	Vertical base with bracket Spring-loaded terminals	Black	1	SL7-L-... SL7-BL-... SL7-FL-... SL7-AP-...	SL7-CB-FW

For Mounting on Both Sides—Includes Cover, Maximum 2 x 5 Modules

	Description	Color	Standard Pack	For use with ...	Catalog Number
SL7-CB-D 	Base with external fixing holes Spring-loaded terminals	Black	1	SL7-L-... SL7-BL-... SL7-FL-... SL7-AP-...	SL7-CB-D

Technical Data and Specifications

2

SL7 Series

SL7 General Specifications

Description	Specification
Standards	IEC/EN 60947-5-1
Lens color	Blue, green, red, clear, yellow, amber
Number of signal elements	Max. 5 with standard base Max. 10 with base for mounting on both sides
Mechanical Ratings	
Shock (IEC 68-2-27)	11 ms, 15g
Vibration (IEC 68-2-6)	20 sweeps 10–150 Hz, 1g
Climate Conditions	
Climatic proofing	Damp heat, constant, to IEC 60068-2-78 Damp heat, cyclic, to IEC 60069-2-30
Operating temperature	–22° to +140°F (–30° to +60°C)
Storage temperature	–22° to +185°F (–30° to +85°C)
Environmental Ratings	
IEC degree of protection	UL Type 4/4X/13, IP66 IEC/EN 60529
Protection type UL	Type 4/4X/13
Materials	
Cover	Polycarbonate
Lenses	Polycarbonate
Stacklight base	Polycarbonate
Tubes	Aluminum
Terminal Capacity	
Solid or flexible conductor	0.13–2.5 mm ²
Flexible with ferrule with plastic collar	0.25–1.5 mm ² AWG 24–AWG 14
Contacts	
Rated impulse withstand voltage (U _{imp})	4000 Vac
Rated insulation voltage (U _i)	250V
Overvoltage category/pollution degree	III/3





















SL7 Light Module Specifications

	Unit	SL7-L-...-...	SL7-BL-...-...	SL7-FL-...-...	SL7-L24-...-HP	SL7-FL24-...-HP	SL7-FL24-...-HPM	SL7-L-...
Type of light		Continuous light	Flashing light	Strobe light	Continuous light	Strobe light	Multi-strobe light	Continuous light
Light elements		LED	LED	LED	High-performance LED	High-performance LED	High-performance LED	Incandescent bulb (max. 7W)
Mounting		—	—	—	—	—	—	Ba15d
Flashing/strobe frequency		—	2 Hz	1.4 Hz	—	1.4 Hz	1–2.6 Hz	—
Transmission angle		360°	360°	360°	360°	360°	360°	360°
Leakage current	A	<0.003	<0.003	<0.003	<0.003	<0.003	<0.003	<0.003
Current-/power consumption								
24 Vac/Vdc	A	0.049–0.054	0.058	0.130–0.135	0.170–0.200	0.260–0.265	0.260–0.265	—
110/120 Vac	A	0.028–0.031	0.028–0.030	0.010	—	—	—	—
230/240 Vac	A	0.027–0.028	0.030–0.031	0.010	—	—	—	—
Power consumption		—	—	—	—	—	—	Max. 7W with the specified voltages
Voltage levels		24 Vac/Vdc ± 10% 110/120 Vac ± 10% 230/240 Vac ± 10%	24 Vac/Vdc ± 10% 110/120 Vac ± 10% 230/240 Vac ± 10%	24 Vac/Vdc ± 10% 110/120 Vac ± 10% 230/240 Vac ± 10%	18–30 Vdc/ 18–26 Vac	18–30 Vdc/ 18–26 Vac	18–30 Vdc/ 18–26 Vac	Up to 250 Vac/Vdc
Lifespan	h	100,000	100,000	100,000	50,000	50,000	50,000	3000
Weight	g	80	80	80	80	80	80	80

SL7 Acoustic Module Specifications

	Unit	SL7-AP...	SL7-AP...-E	SL7-AP...-M
Type of tone		Continuous or pulsed tone	Continuous or pulsed tone	Continuous or pulsed tone Eight types of sound
Types of sound		Two versions, table of sound types	Two versions, table of sound types	Eight versions, table of sound types
Sound setting		Internal; single-pole DIP	Can be externally actuated	Internal; three-pole DIP
Sound pressure	dB	Max.: 100 Min.: 88	Max.: 100 Min.: 88	Max.: 100 Min.: 88
Sound pressure level adjustment		Built-in, potentiometer	Built-in, potentiometer	Built-in, potentiometer
Transmission angle		360°	360°	360°
Current-/power consumption				
24 Vac/Vdc	A	0.092	0.092	0.115
110/120 Vac	A	0.041	0.041	0.045
230/240 Vac	A	0.043	0.043	0.043
Voltage levels		24 Vac/Vdc ± 10% 110/120 Vac ± 10% 230/240 Vac ± 10%	24 Vac/Vdc ± 10% 110/120 Vac ± 10% 230/240 Vac ± 10%	24 Vac/Vdc ± 10% 110/120 Vac ± 10% 230/240 Vac ± 10%
Weight	g	102	102	102

SL7 Table of Sound Types

	Sound Type	Frequency (Hz)	Diagram	Repeat Rate	DIP Switch Position	Maximum Volume at 1M (dB)
SL7-AP...	Continuous tone	Approx. 2800		—	—	100
	Pulsed tone	Approx. 2800		Approx. 2 Hz	—	100
SL7-AP...-E	Continuous tone	Approx. 2800		—	—	100
	Pulsed tone	Approx. 2800		Approx. 2 Hz	—	100
SL7-AP...-M	Continuous tone	2700		—	ON 	Tone 01 100
	Continuous tone	1350		—	ON 	Tone 02 100
	Pulsed tone	2700		250 ms on, 250 ms off	ON 	Tone 03 100
	Pulsed tone	1350		250 ms on, 250 ms off	ON 	Tone 04 100
	Falling	1200–500		1 Hz	ON 	Tone 05 98
	Rising	500–1200		Rising 3s, 0.5s off	ON 	Tone 06 98
	Alternating	800–1000		2 Hz	ON 	Tone 07 94
	rising/falling	500–1500		10 Hz	ON 	Tone 08 94

Dimensions

Approximate Dimensions in Inches (mm)

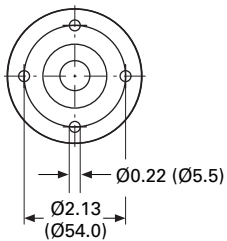
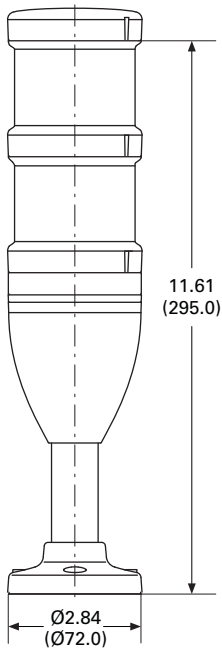
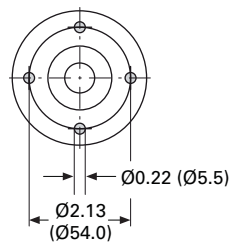
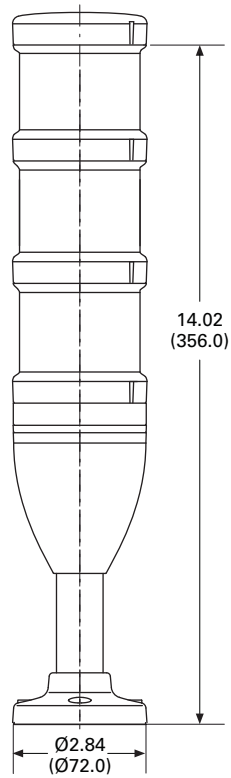
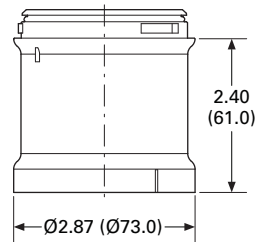
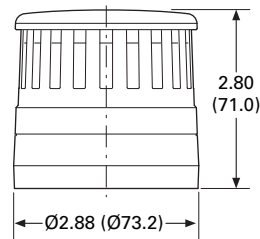
SL7 Series**Complete Devices****SL7-100-L-RG-24LED****SL7-100-L-RYG-24LED****Light Modules****SL7-(B)(F)L...****Acoustic Modules****SL7-AP...**

2.1

Stacklights

SL Series

Approximate Dimensions in Inches (mm)

2

Basic Modules

SL7-CB-...

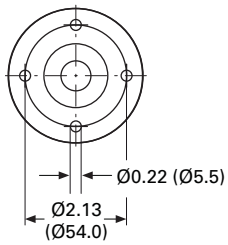
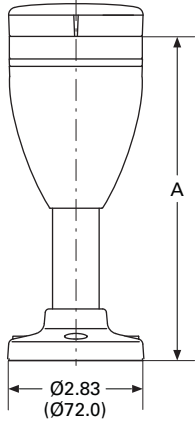

Catalog Number	A
SL7-CB-100	6.73 (171.0)
SL7-CB-250	12.64 (321.0)
SL7-CB-400	18.54 (471.0)

SL7-CB-T...

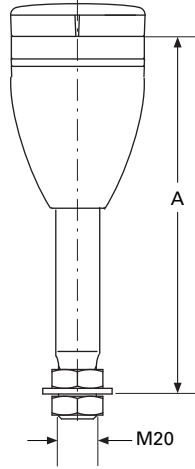

Catalog Number	A
SL7-CB-T-100	7.48 (190.0)
SL7-CB-T-250	13.38 (340.0)
SL7-CB-T-400	19.29 (490.0)

SL7-CB-D

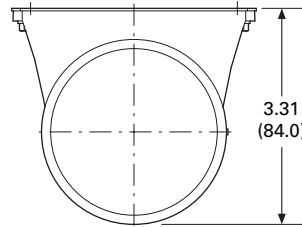
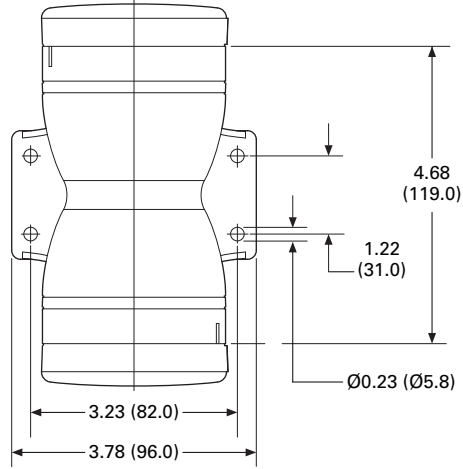

SL7-CB-EMH

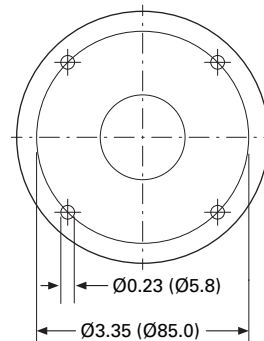
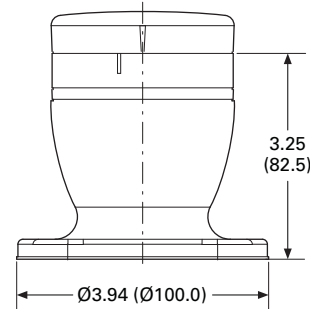

Approximate Dimensions in Inches (mm)

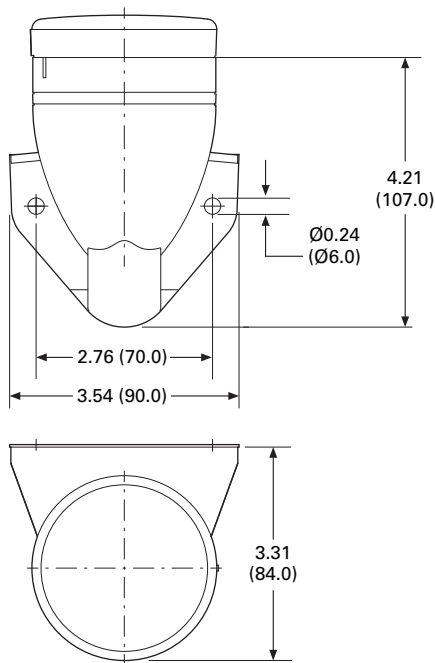
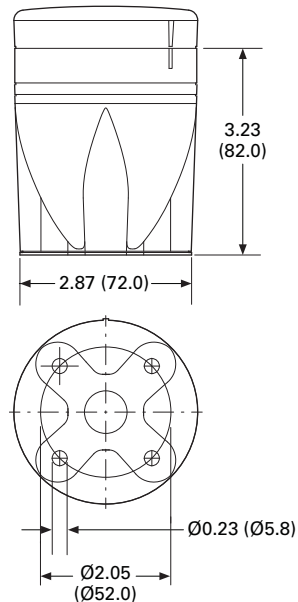
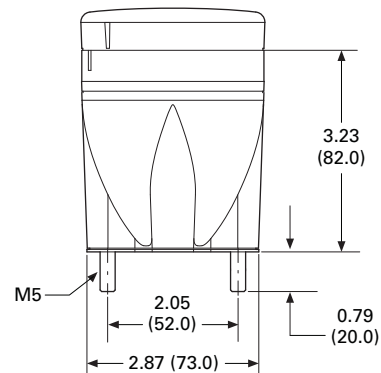
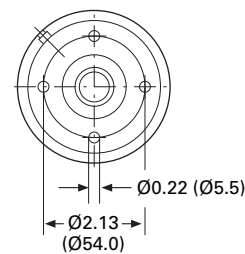
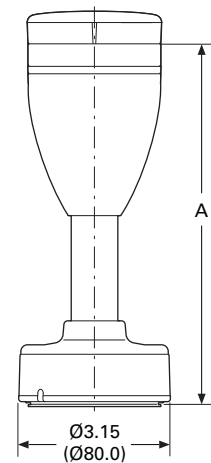
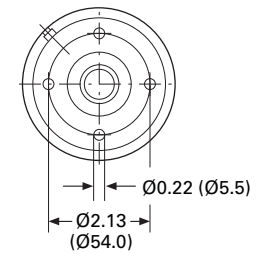
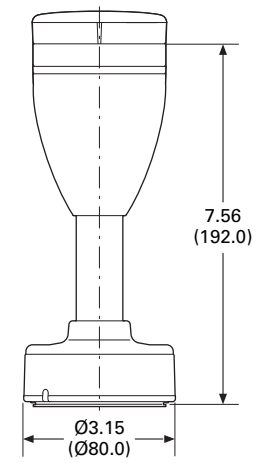
SL7-CB-FW**SL7-CB-IMH****SL7-CB-IMS****SL7-FMS-...****SL7-SWD ①**

Catalog Number	A
SL7-FMS-100	7.55 (192.0)
SL7-FMS-250	13.46 (342.0)
SL7-FMS-400	19.37 (192.0)

Note

① For connecting to SmartWire-DT.