



NVENT CADDY SPEED LINK SLK WITH Y-HOOK, 9.9' LENGTH, 19.6" Y-LENGTH

CATALOG NUMBER

SLK2YH500L3



CERTIFICATIONS



FEATURES

Complete system includes wire, locking device and two pre-assembled hook end fittings

Fastens to the building structure and hooks to hanging services and tray

Spring latch helps provide secure connection

Convenient design allows one hook to be temporarily detached for maintenance or to add cables to the tray

Single drop with double hook provides increased stability to the system

Also available in a single-hook end fitting configuration

PRODUCT ATTRIBUTES

Material: Steel;Zinc Alloy;Polypropylene

Finish: Electrogalvanized

Static Load Safety Factor: 5:1

Complies With: SMACNA HVAC-DCS

Wire Rope Diameter: 2 mm

Wire Rope Length: 9.9'

Wire Rope "Y" Length (YL): 19.6"

A: 2.3"

B: 0.9"

C: 1/4"

Static Load (F): 100lb

Height (H): 2.15"

Width (W): 3/4"

Thickness (T): 1/2"

Angle (a): 90 ° Max

DIAGRAMS

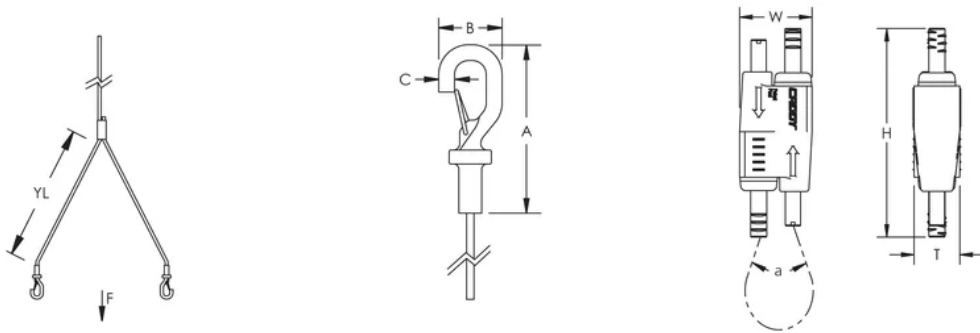

WARNING

nVent products shall be installed and used only as indicated in nVent's product instruction sheets and training materials. Instruction sheets are available at www.nvent.com and from your nVent customer service representative. Improper installation, misuse, misapplication or other failure to completely follow nVent's instructions and warnings may cause product malfunction, property damage, serious bodily injury and death and/or void your warranty.

North America

+1.800.753.9221

Option 1 – Customer Care

Option 2 – Technical Support

Europe

Netherlands:

+31 800-0200135

France:

+33 800 901 793

Europe

Germany:

800 1890272

Other Countries:

+31 13 5835404

APAC

Shanghai:

+ 86 21 2412 1618/19

Sydney:

+61 2 9751 8500



Our powerful portfolio of brands:
nVent.com **CADDY ERICO HOFFMAN RAYCHEM SCHROFF**
TRACER

© 2024 nVent. All nVent marks and logos are owned or licensed by nVent Services GmbH or its affiliates. All other trademarks are the property of their respective owners.

nVent reserves the right to change specifications without notice.



NVENT CADDY SPEED LINK SLK WITH Y-HOOK, 9.9' LENGTH, 19.6" Y-LENGTH

CATALOG NUMBER

SLK2YH500L3



CERTIFICATIONS



FEATURES

Complete system includes wire, locking device and two pre-assembled hook end fittings

Fastens to the building structure and hooks to hanging services and tray

Spring latch helps provide secure connection

Convenient design allows one hook to be temporarily detached for maintenance or to add cables to the tray

Single drop with double hook provides increased stability to the system

Also available in a single-hook end fitting configuration

PRODUCT ATTRIBUTES

Material: Steel;Zinc Alloy;Polypropylene

Finish: Electrogalvanized

Static Load Safety Factor: 5:1

Complies With: SMACNA HVAC-DCS

Wire Rope Diameter: 2 mm

Wire Rope Length: 9.9'

Wire Rope "Y" Length (YL): 19.6"

A: 2.3"

B: 0.9"

C: 1/4"

Static Load (F): 100lb

Height (H): 2.15"

Width (W): 3/4"

Thickness (T): 1/2"

Angle (a): 90 ° Max

DIAGRAMS

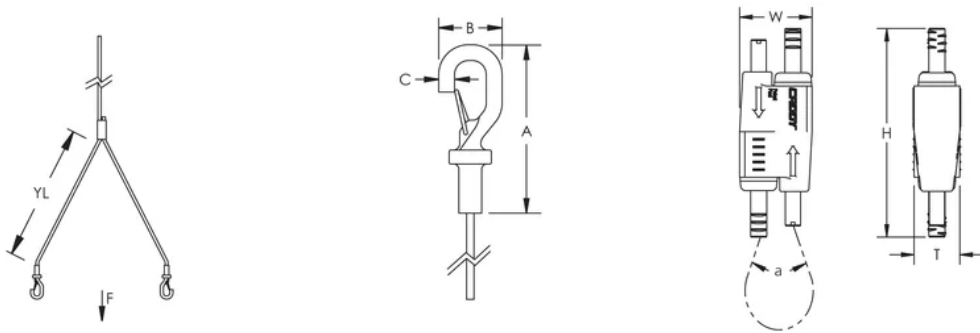

WARNING

nVent products shall be installed and used only as indicated in nVent's product instruction sheets and training materials. Instruction sheets are available at www.nvent.com and from your nVent customer service representative. Improper installation, misuse, misapplication or other failure to completely follow nVent's instructions and warnings may cause product malfunction, property damage, serious bodily injury and death and/or void your warranty.

North America

+1.800.753.9221

Option 1 – Customer Care

Option 2 – Technical Support

Europe

Netherlands:

+31 800-0200135

France:

+33 800 901 793

Europe

Germany:

800 1890272

Other Countries:

+31 13 5835404

APAC

Shanghai:

+ 86 21 2412 1618/19

Sydney:

+61 2 9751 8500



Our powerful portfolio of brands:
nVent.com CADDY ERICO HOFFMAN RAYCHEM SCHROFF
TRACER