

Steel Square Boxes

4" SQUARE OUTLET BOXES & COVERS

Applications:

- For use with conduit
- Available in red for fire alarm applications

Features:

- Ideal for exposed work applications, providing an easy method for the installation of electrical devices (switches, receptacles, fans, lights, etc.)
- Raised ground screw location in the welded boxes saves time in installation
- Available with pre-installed ground screws and pigtails for increased labor savings
- Knockouts are suitable for use without a bonding jumper in circuits above or below 250 volts
- Available in two depths for differing cubic capacity requirements
- Welded or drawn construction to match customer preference
- Extensive cover offering to meet various customer applications and needs

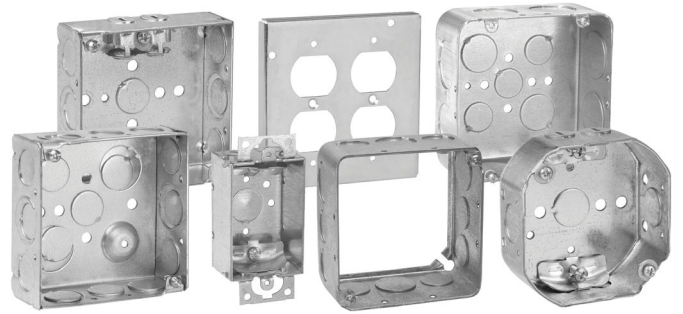

Certifications and Compliances:

- UL Listed

4" SQUARE OUTLET BOXES – 18.0 CUBIC INCH CAPACITY

1¼" DEEP – FOR CONDUIT

UL LISTED



TP408

Knockouts

Cat. #	Bracket	Description	Knockouts		Unit Qty.	Wt. Lbs. Per 100
			Sides	Bottom		
TP408	-	Drawn	12 – ½"	5 – ½"	50	61

Steel Boxes

Steel Square Boxes

4" SQUARE OUTLET BOXES – 22.0 CUBIC INCH CAPACITY (WELDED)† 21.0 CUBIC INCH CAPACITY (DRAWN)

1½" DEEP – FOR CONDUIT

UL LISTED



TP404/TP404PF

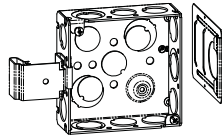

TP404SSB



TP404MSB



TP404RED

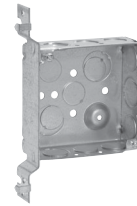

TP425



TP469



TP830*



TP405



TP412
TP839*



TP410



TP414RED



TP414

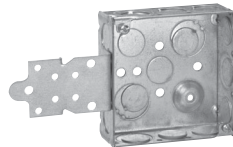

TP418

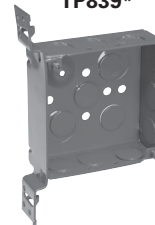

TP423RED

Knockouts

Cat. #	Metal Stud Sizes	Bracket	Description	Sides	Bottom	Unit Qty.	Wt. Lbs. Per 100
TP404**	-	-	Welded	8 - ½", 4 - ½" + ¾" E	2 - ½", 2 - ½" + ¾" E	50	72
TP404MSB	-	MSB	Welded	8 - ½", 4 - ½" + ¾" E	2 - ½", 2 - ½" + ¾" E	25	83
TP404RED	-	-	Welded	8 - ½", 4 - ½" + ¾" E	2 - ½", 2 - ½" + ¾" E	50	72
TP404REDMSB	-	MSB	Welded	8 - ½", 4 - ½" + ¾" E	2 - ½", 2 - ½" + ¾" E	25	83
TP404PF+**	-	-	Welded	8 - ½", 4 - ½" + ¾" E	2 - ½", 2 - ½" + ¾" E	50	72
TP404SSB	-	SSB	Welded	8 - ½", 4 - ½" + ¾" E	2 - ½", 2 - ½" + ¾" E	50	83
TP425**	All	"VP"	Welded	6 - ½", 3 - ½" + ¾" E	2 - ½", 2 - ½" + ¾" E	25	82
TP423**	All	"VMS"	Welded	6 - ½", 3 - ½" + ¾" E	2 - ½", 2 - ½" + ¾" E	25	81
TP423RED	All	"VMS"	Welded	6 - ½", 3 - ½" + ¾" E	2 - ½", 2 - ½" + ¾" E	25	81
TP405	-	-	Drawn	4 - ½", 6 - ½" + ¾" C	3 - ½", 2 - ¾"	50	67
TP410	-	-	Drawn	12 - ½"	5 - ½"	50	67
TP412	-	-	Drawn	8 - ¾"	3 - ½", 2 - ¾"	50	67
TP414	-	-	Drawn	8 - ½", 4 - ¾"	3 - ½", 2 - ¾"	50	67
TP414RED	-	-	Drawn	8 - ½", 4 - ¾"	3 - ½", 2 - ¾"	50	67
TP418	-	"F", Set Flush	Welded	6 - ½", 3 - ½" + ¾" E	2 - ½", 2 - ½" + ¾" E	25	84
TP467	-	-	Welded	8 - ¾"	2 - ½", 2 - ½" + ¾" E	50	72
TP467MSB	-	MSB	Welded	8 - ¾"	2 - ½", 2 - ½" + ¾" E	25	78
TP469	All	"VMS"	Welded	6 - ¾"	2 - ½", 2 - ½" + ¾" E	25	81
Air Plenum							
TP830*	-	-	Drawn	8 - ½", 4 - ¾"	3 - ½", 2 - ¾"	50	72
TP839*	-	-	Drawn	8 - ¾" C	3 - ½", 2 - ¾"	50	72

*For Air Plenum (no mounting holes) - not UL Listed.

**cUL Listed.

†All welded 4" Square Outlet Boxes have a raised dimple for ground screw.

‡TP404PF includes ground screw with pigtail lead.

Steel Boxes

Steel Square Boxes

4" SQUARE OUTLET BOXES – 22.0 CUBIC INCH CAPACITY

1½" DEEP
FOR NON-METALLIC CABLE – CLAMPS IN EACH END
UL LISTED

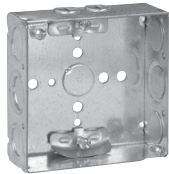

TP444

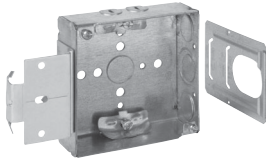

TP444MSB

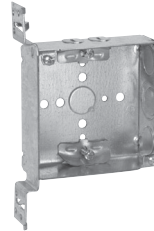

TP449

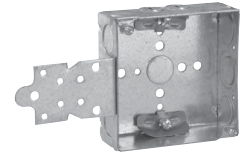

TP446

Cat. #	Bracket	Description	Knockouts		Unit Qty.	Wt. Lbs. Per 100
			Sides	Bottom		
TP444	-	Welded	4 - Cable, 4 - ½", 2 - ½" + ¾" E	1 - ½"	50	77
TP444MSB	MSB	Welded	4 - Cable, 4 - ½", 2 - ½" + ¾" E	1 - ½"	25	81
TP444SSB	SSB	Welded	4 - Cable, 4 - ½", 2 - ½" + ¾" E	1 - ½"	50	88
TP446	"F", Set Flush	Welded	4 - Cable, 2 - ½", 1 - ½" + ¾" E	1 - ½"	25	88
TP449	"VMS"	Welded	4 - Cable, 2 - ½", 1 - ½" + ¾" E	1 - ½"	25	85

4" SQUARE OUTLET BOXES – 22.0 CUBIC INCH CAPACITY

1½" DEEP
FOR ARMoured & METAL-CLAD (MCI) CABLE & HCF CABLE – CLAMPS IN EACH END
UL LISTED

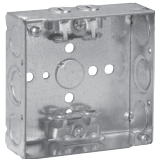

TP454

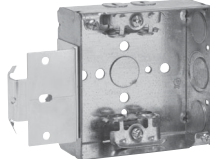

TP454MSB

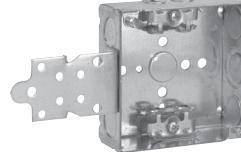

TP456

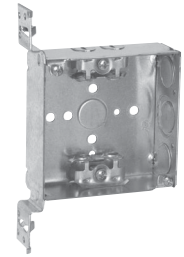

TP459

Steel Boxes

Cat. #	Bracket	Description	Knockouts		Unit Qty.	Wt. Lbs. Per 100
			Sides	Bottom		
TP459	"VMS"	Welded	4 - Cable, 2 - ½", 1 - ½" + ¾" E	1 - ½"	25	89
TP454*	-	Welded	4 - Cable, 4 - ½", 2 - ½" + ¾" E	1 - ½"	50	81
TP454MSB	MSB	Welded	4 - Cable, 4 - ½", 2 - ½" + ¾" E	1 - ½"	25	91
TP454PF†	-	Welded	4 - Cable, 4 - ½", 2 - ½" + ¾" E	1 - ½"	50	81
TP454SSB*	SSB	Welded	4 - Cable, 4 - ½", 2 - ½" + ¾" E	1 - ½"	25	82
TP456*	"F", Set Flush	Welded	4 - Cable, 2 - ½", 1 - ½" + ¾" E	1 - ½"	25	92
TP456PF†	"F", Set Flush	Welded	4 - Cable, 2 - ½", 1 - ½" + ¾" E	1 - ½"	25	92

*UL approved for use with aluminum interlocking grounding metal-clad cable, Type MCIA (Southwire MCAP™).

MCAP™ is a registered trademark of Southwire Company.

†TP catalog numbers ending in PF include ground screw with pigtail lead.

Steel Square Boxes

4" SQUARE OUTLET BOXES – 30.3 CUBIC INCH CAPACITY

2 1/8" DEEP – FOR CONDUIT

UL LISTED



TP403/TP403PF

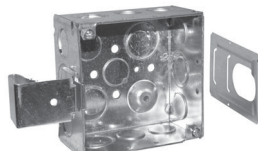

TP403SSB

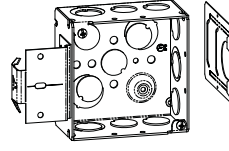

TP403MSB



TP432

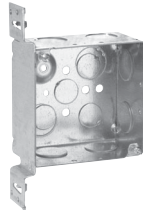

TP432VMS



TP434



TP438
TP831*



TP403RED



TP434RED



TP451RED

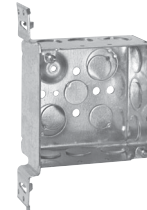

TP451

Knockouts

Cat. #	Bracket	Description	Knockouts		Unit Qty.	Wt. Lbs. Per 100
			Sides	Bottom		
TP403**	-	Welded	8 - 1/2", 4 - 1/2" + 3/4" E	2 - 1/2", 2 - 1/2" + 3/4" E	25	84
TP403MSB	MSB	Welded	8 - 1/2", 4 - 1/2" + 3/4" E	2 - 1/2", 2 - 1/2" + 3/4" E	25	95
TP403RED	-	Welded	8 - 1/2", 4 - 1/2" + 3/4" E	2 - 1/2", 2 - 1/2" + 3/4" E	25	84
TP403REDMSB	MSB	Welded	8 - 1/2", 4 - 1/2" + 3/4" E	2 - 1/2", 2 - 1/2" + 3/4" E	25	95
TP403PF†**	-	Welded	8 - 1/2", 4 - 1/2" + 3/4" E	2 - 1/2", 2 - 1/2" + 3/4" E	25	84
TP403SSB	SSB	Welded	8 - 1/2", 4 - 1/2" + 3/4" E	2 - 1/2", 2 - 1/2" + 3/4" E	25	95
TP432**	-	Welded	8 - 3/4"	2 - 1/2", 2 - 1/2" + 3/4" E	25	84
TP432MSB	MSB	Welded	8 - 3/4"	2 - 1/2", 2 - 1/2" + 3/4" E	25	95
TP432REDMSB	MSB	Welded	8 - 3/4"	2 - 1/2", 2 - 1/2" + 3/4" E	25	95
TP432VMS	"VMS"	Welded	6 - 3/4"	2 - 1/2", 2 - 1/2" + 3/4" E	25	99
TP436	-	Welded	8 - 1"	2 - 1/2", 2 - 1/2" + 3/4" E	25	84
TP436MSB	MSB	Welded	8 - 1"	2 - 1/2", 2 - 1/2" + 3/4" E	25	95
TP434	-	Drawn	8 - 1/2", 4 - 3/4"	3 - 1/2", 2 - 3/4"	25	84
TP434RED	-	Drawn	8 - 1/2", 4 - 3/4"	3 - 1/2", 2 - 3/4"	25	84
TP438	-	Drawn	4 - 1/2", 6 - 1/2" + 3/4" C	3 - 1/2", 2 - 3/4"	25	84
TP438PF†	-	Drawn	4 - 1/2", 6 - 1/2" + 3/4" C	3 - 1/2", 2 - 3/4"	25	84
TP451	"VMS"	Welded	6 - 1/2", 3 - 1/2" + 3/4" E	2 - 1/2", 2 - 1/2" + 3/4" E	25	96
TP451PF†	"VMS"	Welded	6 - 1/2", 3 - 1/2" + 3/4" E	2 - 1/2", 2 - 1/2" + 3/4" E	25	96
TP451RED	"VMS"	Welded	6 - 1/2", 3 - 1/2" + 3/4" E	2 - 1/2", 2 - 1/2" + 3/4" E	25	96
TP437	"VP"	Welded	6 - 1/2", 3 - 1/2" + 3/4" E	2 - 1/2", 2 - 1/2" + 3/4" E	25	98
Air Plenum						
TP831*	-	Drawn	8 - 1/2", 4 - 3/4"	3 - 1/2", 2 - 3/4"	25	90

*For Air Plenum (no mounting holes) - not UL Listed.

**cUL Listed.

†TP catalog numbers ending in PF include ground screw with pigtail lead.

Steel Boxes

Steel Square Boxes

4" SQUARE OUTLET BOXES – 30.3 CUBIC INCH CAPACITY

2 1/8" DEEP
FOR NON-METALLIC CABLE – CLAMPS IN EACH END
UL LISTED

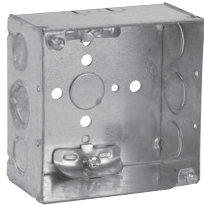

TP450

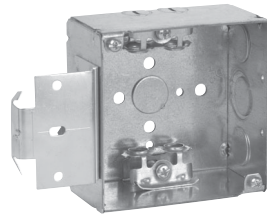

TP450MSB

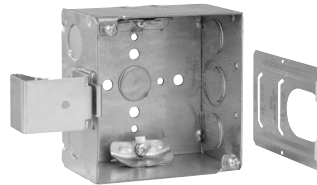

TP450SSB

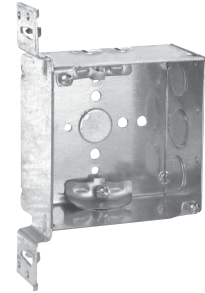

TP452

Cat. #	Bracket	Description	Knockouts		Unit Qty.	Wt. Lbs. Per 100
			Sides	Bottom		
TP450	-	Welded	4 - Cable, 4 - 1/2", 2 - 1/2" + 3/4" E	1 - 1/2"	25	90
TP450MSB	MSB	Welded	4 - Cable, 4 - 1/2", 2 - 1/2" + 3/4" E	1 - 1/2"	25	101
TP450SSB	SSB	Welded	4 - Cable, 4 - 1/2", 2 - 1/2" + 3/4" E	1 - 1/2"	25	101
TP452	"VMS"	Welded	4 - Cable, 2 - 1/2", 1 - 1/2" + 3/4" E	1 - 1/2"	25	104

4" SQUARE OUTLET BOXES – 30.3 CUBIC INCH CAPACITY

2 1/8" DEEP
FOR ARMoured & METAL-CLAD (MCI) CABLE & HCF CABLE – CLAMPS IN EACH END
UL LISTED

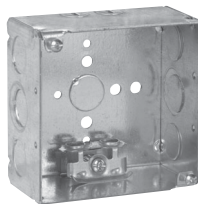

TP431

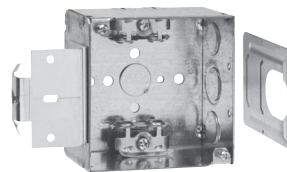

TP431MSB

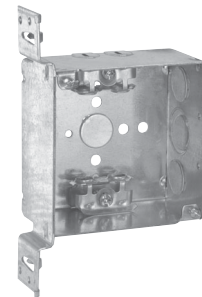

TP440

Cat. #	Metal Stud Sizes	Bracket	Description	Knockouts		Unit Qty.	Wt. Lbs. Per 100
				Sides	Bottom		
TP431*	-	-	Welded	4 - Cable, 4 - 1/2", 2 - 1/2" & 3/4" E	1 - 1/2"	25	91
TP431PF†	-	-	Welded	4 - Cable, 4 - 1/2", 2 - 1/2" & 3/4" E	1 - 1/2"	25	91
TP431MSB	-	MSB	Welded	4 - Cable, 4 - 1/2", 2 - 1/2" & 3/4" E	1 - 1/2"	25	91
TP431SSB*	-	SSB	Welded	4 - Cable, 4 - 1/2", 2 - 1/2" & 3/4" E	1 - 1/2"	25	102
TP440*	All	"VMS"	Welded	4 - Cable, 2 - 1/2", 1 - 1/2" & 3/4" E	1 - 1/2"	25	103

*UL approved for use with aluminum interlocking grounding metal-clad cable, Type MCIA (Southwire MCAP™).

MCAP™ is a registered trademark of Southwire Company.

†TTP catalog numbers ending in PF include ground screw with pigtail lead.

Steel Boxes

Steel Square Boxes

4" SQUARE TWO DEVICE BOXES – 30.3 CUBIC INCH CAPACITY

2 1/8" DEEP – FOR CONDUIT

UL LISTED



TP391

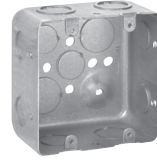

TP395

Cat. #	Bracket	Description	Knockouts		Unit Qty.	Wt. Lbs. Per 100
			Sides	Bottom		
TP391	"VS", Set 7/8"	Drawn	6 - 1/2", 3 - 3/4"	3 - 1/2", 2 - 3/4"	25	95
TP395	-	Drawn	8 - 1/2", 4 - 3/4"	3 - 1/2", 2 - 3/4"	25	84

4" SQUARE OUTLET BOXES – 46.0 CUBIC INCH CAPACITY

3 1/2" DEEP – FOR CONDUIT

UL LISTED, FILE NO. E-15022

Applications:

- 4" square, 3 1/2" deep outlet boxes are ideal for applications requiring increased capacity, including the installation of speaker boxes, fire alarms, strobes, security cameras and other oversized devices
- For use with rigid/IMC and EMT conduit



TP411

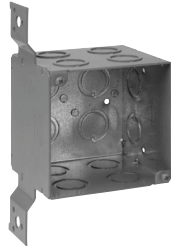

TP411RED

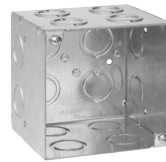

TP413

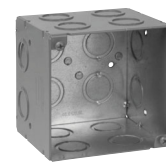

TP413RED

Cat. #	Bracket	Description	Knockouts		Unit Qty.	Wt. Lbs. Per 100
			Sides	Bottom		
TP411	Side	Welded	12 - 1/2" + 3/4" C	4 - 1/2" + 3/4" C	10	137
TP411RED	Side	Welded	12 - 1/2" + 3/4" C	4 - 1/2" + 3/4" C	10	137
TP413	-	Welded	12 - 1/2" + 3/4" C	4 - 1/2" + 3/4" C	20	125
TP413RED	-	Welded	12 - 1/2" + 3/4" C	4 - 1/2" + 3/4" C	20	125

Steel Square Boxes

4" SQUARE OUTLET BOXES & COVERS

Applications:

- For use with conduit
- Available in red for fire alarm applications

Features:

- Ideal for exposed work applications, providing an easy method for the installation of electrical devices (switches, receptacles, fans, lights, etc.)
- Raised ground screw location in the welded boxes saves time in installation
- Available with pre-installed ground screws and pigtails for increased labor savings
- Knockouts are suitable for use without a bonding jumper in circuits above or below 250 volts
- Available in two depths for differing cubic capacity requirements
- Welded or drawn construction to match customer preference
- Extensive cover offering to meet various customer applications and needs

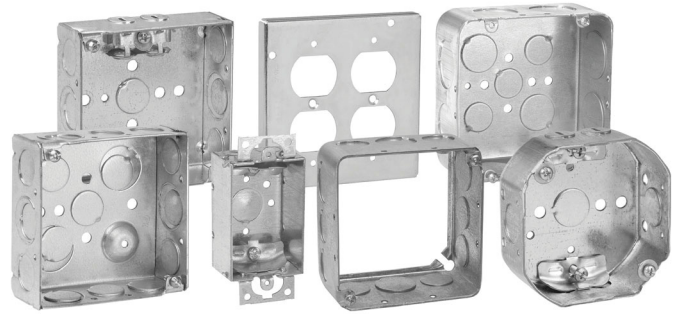

Certifications and Compliances:

- UL Listed

4" SQUARE OUTLET BOXES – 18.0 CUBIC INCH CAPACITY

1¼" DEEP – FOR CONDUIT

UL LISTED



TP408

Knockouts

Cat. #	Bracket	Description	Knockouts		Unit Qty.	Wt. Lbs. Per 100
			Sides	Bottom		
TP408	-	Drawn	12 – ½"	5 – ½"	50	61

Steel Boxes

Steel Square Boxes

4" SQUARE OUTLET BOXES – 22.0 CUBIC INCH CAPACITY (WELDED)† 21.0 CUBIC INCH CAPACITY (DRAWN)

1½" DEEP – FOR CONDUIT

UL LISTED



TP404/TP404PF

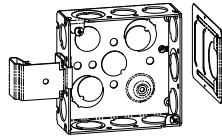

TP404SSB



TP404MSB



TP404RED

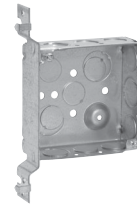

TP425



TP469



TP830*



TP405



TP412
TP839*



TP410



TP414RED



TP414

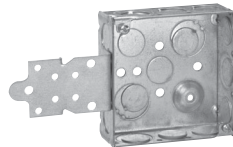

TP418



TP423RED

Knockouts

Cat. #	Metal Stud Sizes	Bracket	Description	Sides	Bottom	Unit Qty.	Wt. Lbs. Per 100
TP404**	-	-	Welded	8 - ½", 4 - ½" + ¾" E	2 - ½", 2 - ½" + ¾" E	50	72
TP404MSB	-	MSB	Welded	8 - ½", 4 - ½" + ¾" E	2 - ½", 2 - ½" + ¾" E	25	83
TP404RED	-	-	Welded	8 - ½", 4 - ½" + ¾" E	2 - ½", 2 - ½" + ¾" E	50	72
TP404REDMSB	-	MSB	Welded	8 - ½", 4 - ½" + ¾" E	2 - ½", 2 - ½" + ¾" E	25	83
TP404PF†**	-	-	Welded	8 - ½", 4 - ½" + ¾" E	2 - ½", 2 - ½" + ¾" E	50	72
TP404SSB	-	SSB	Welded	8 - ½", 4 - ½" + ¾" E	2 - ½", 2 - ½" + ¾" E	50	83
TP425**	All	"VP"	Welded	6 - ½", 3 - ½" + ¾" E	2 - ½", 2 - ½" + ¾" E	25	82
TP423**	All	"VMS"	Welded	6 - ½", 3 - ½" + ¾" E	2 - ½", 2 - ½" + ¾" E	25	81
TP423RED	All	"VMS"	Welded	6 - ½", 3 - ½" + ¾" E	2 - ½", 2 - ½" + ¾" E	25	81
TP405	-	-	Drawn	4 - ½", 6 - ½" + ¾" C	3 - ½", 2 - ¾"	50	67
TP410	-	-	Drawn	12 - ½"	5 - ½"	50	67
TP412	-	-	Drawn	8 - ¾"	3 - ½", 2 - ¾"	50	67
TP414	-	-	Drawn	8 - ½", 4 - ¾"	3 - ½", 2 - ¾"	50	67
TP414RED	-	-	Drawn	8 - ½", 4 - ¾"	3 - ½", 2 - ¾"	50	67
TP418	-	"F", Set Flush	Welded	6 - ½", 3 - ½" + ¾" E	2 - ½", 2 - ½" + ¾" E	25	84
TP467	-	-	Welded	8 - ¾"	2 - ½", 2 - ½" + ¾" E	50	72
TP467MSB	-	MSB	Welded	8 - ¾"	2 - ½", 2 - ½" + ¾" E	25	78
TP469	All	"VMS"	Welded	6 - ¾"	2 - ½", 2 - ½" + ¾" E	25	81
Air Plenum							
TP830*	-	-	Drawn	8 - ½", 4 - ¾"	3 - ½", 2 - ¾"	50	72
TP839*	-	-	Drawn	8 - ¾" C	3 - ½", 2 - ¾"	50	72

*For Air Plenum (no mounting holes) - not UL Listed.

**cUL Listed.

†All welded 4" Square Outlet Boxes have a raised dimple for ground screw.

‡TP404PF includes ground screw with pigtail lead.

Steel Boxes

Steel Square Boxes

4" SQUARE OUTLET BOXES – 22.0 CUBIC INCH CAPACITY

1½" DEEP
FOR NON-METALLIC CABLE – CLAMPS IN EACH END
UL LISTED

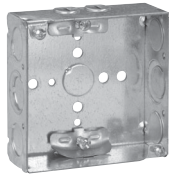

TP444

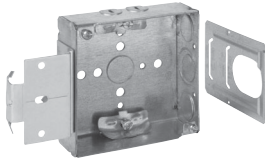

TP444MSB

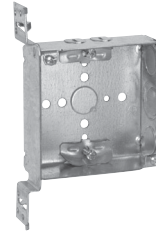

TP449

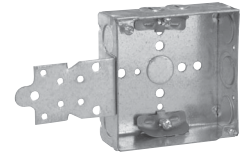

TP446

Cat. #	Bracket	Description	Knockouts		Unit Qty.	Wt. Lbs. Per 100
			Sides	Bottom		
TP444	-	Welded	4 - Cable, 4 - ½", 2 - ½" + ¾" E	1 - ½"	50	77
TP444MSB	MSB	Welded	4 - Cable, 4 - ½", 2 - ½" + ¾" E	1 - ½"	25	81
TP444SSB	SSB	Welded	4 - Cable, 4 - ½", 2 - ½" + ¾" E	1 - ½"	50	88
TP446	"F", Set Flush	Welded	4 - Cable, 2 - ½", 1 - ½" + ¾" E	1 - ½"	25	88
TP449	"VMS"	Welded	4 - Cable, 2 - ½", 1 - ½" + ¾" E	1 - ½"	25	85

4" SQUARE OUTLET BOXES – 22.0 CUBIC INCH CAPACITY

1½" DEEP
FOR ARMoured & METAL-CLAD (MCI) CABLE & HCF CABLE – CLAMPS IN EACH END
UL LISTED

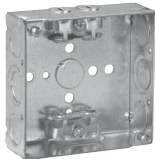

TP454

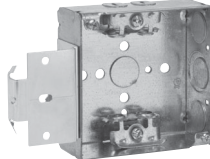

TP454MSB

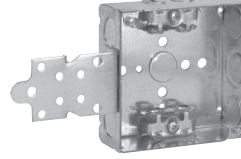

TP456

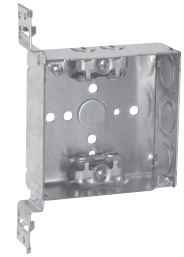

TP459

Steel Boxes

Cat. #	Bracket	Description	Knockouts		Unit Qty.	Wt. Lbs. Per 100
			Sides	Bottom		
TP459	"VMS"	Welded	4 - Cable, 2 - ½", 1 - ½" + ¾" E	1 - ½"	25	89
TP454*	-	Welded	4 - Cable, 4 - ½", 2 - ½" + ¾" E	1 - ½"	50	81
TP454MSB	MSB	Welded	4 - Cable, 4 - ½", 2 - ½" + ¾" E	1 - ½"	25	91
TP454PF†	-	Welded	4 - Cable, 4 - ½", 2 - ½" + ¾" E	1 - ½"	50	81
TP454SSB*	SSB	Welded	4 - Cable, 4 - ½", 2 - ½" + ¾" E	1 - ½"	25	82
TP456*	"F", Set Flush	Welded	4 - Cable, 2 - ½", 1 - ½" + ¾" E	1 - ½"	25	92
TP456PF†	"F", Set Flush	Welded	4 - Cable, 2 - ½", 1 - ½" + ¾" E	1 - ½"	25	92

*UL approved for use with aluminum interlocking grounding metal-clad cable, Type MCIA (Southwire MCAP™).

MCAP™ is a registered trademark of Southwire Company.

†TP catalog numbers ending in PF include ground screw with pigtail lead.

Steel Square Boxes

4" SQUARE OUTLET BOXES – 30.3 CUBIC INCH CAPACITY

2 1/8" DEEP – FOR CONDUIT

UL LISTED



TP403/TP403PF

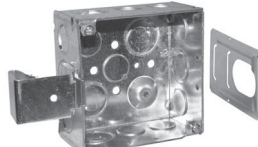

TP403SSB

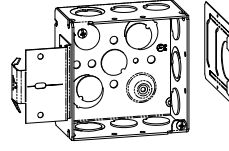

TP403MSB



TP432

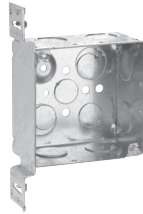

TP432VMS



TP434



TP438
TP831*



TP403RED



TP434RED



TP451RED

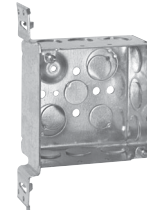

TP451

Knockouts

Cat. #	Bracket	Description	Knockouts		Unit Qty.	Wt. Lbs. Per 100
			Sides	Bottom		
TP403**	-	Welded	8 - 1/2", 4 - 1/2" + 3/4" E	2 - 1/2", 2 - 1/2" + 3/4" E	25	84
TP403MSB	MSB	Welded	8 - 1/2", 4 - 1/2" + 3/4" E	2 - 1/2", 2 - 1/2" + 3/4" E	25	95
TP403RED	-	Welded	8 - 1/2", 4 - 1/2" + 3/4" E	2 - 1/2", 2 - 1/2" + 3/4" E	25	84
TP403REDMSB	MSB	Welded	8 - 1/2", 4 - 1/2" + 3/4" E	2 - 1/2", 2 - 1/2" + 3/4" E	25	95
TP403PF†**	-	Welded	8 - 1/2", 4 - 1/2" + 3/4" E	2 - 1/2", 2 - 1/2" + 3/4" E	25	84
TP403SSB	SSB	Welded	8 - 1/2", 4 - 1/2" + 3/4" E	2 - 1/2", 2 - 1/2" + 3/4" E	25	95
TP432**	-	Welded	8 - 3/4"	2 - 1/2", 2 - 1/2" + 3/4" E	25	84
TP432MSB	MSB	Welded	8 - 3/4"	2 - 1/2", 2 - 1/2" + 3/4" E	25	95
TP432REDMSB	MSB	Welded	8 - 3/4"	2 - 1/2", 2 - 1/2" + 3/4" E	25	95
TP432VMS	"VMS"	Welded	6 - 3/4"	2 - 1/2", 2 - 1/2" + 3/4" E	25	99
TP436	-	Welded	8 - 1"	2 - 1/2", 2 - 1/2" + 3/4" E	25	84
TP436MSB	MSB	Welded	8 - 1"	2 - 1/2", 2 - 1/2" + 3/4" E	25	95
TP434	-	Drawn	8 - 1/2", 4 - 3/4"	3 - 1/2", 2 - 3/4"	25	84
TP434RED	-	Drawn	8 - 1/2", 4 - 3/4"	3 - 1/2", 2 - 3/4"	25	84
TP438	-	Drawn	4 - 1/2", 6 - 1/2" + 3/4" C	3 - 1/2", 2 - 3/4"	25	84
TP438PF†	-	Drawn	4 - 1/2", 6 - 1/2" + 3/4" C	3 - 1/2", 2 - 3/4"	25	84
TP451	"VMS"	Welded	6 - 1/2", 3 - 1/2" + 3/4" E	2 - 1/2", 2 - 1/2" + 3/4" E	25	96
TP451PF†	"VMS"	Welded	6 - 1/2", 3 - 1/2" + 3/4" E	2 - 1/2", 2 - 1/2" + 3/4" E	25	96
TP451RED	"VMS"	Welded	6 - 1/2", 3 - 1/2" + 3/4" E	2 - 1/2", 2 - 1/2" + 3/4" E	25	96
TP437	"VP"	Welded	6 - 1/2", 3 - 1/2" + 3/4" E	2 - 1/2", 2 - 1/2" + 3/4" E	25	98
Air Plenum						
TP831*	-	Drawn	8 - 1/2", 4 - 3/4"	3 - 1/2", 2 - 3/4"	25	90

*For Air Plenum (no mounting holes) - not UL Listed.

**cUL Listed.

†TP catalog numbers ending in PF include ground screw with pigtail lead.

Steel Boxes

Steel Square Boxes

4" SQUARE OUTLET BOXES – 30.3 CUBIC INCH CAPACITY

2 1/8" DEEP
FOR NON-METALLIC CABLE – CLAMPS IN EACH END
UL LISTED

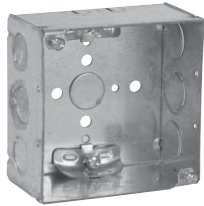

TP450

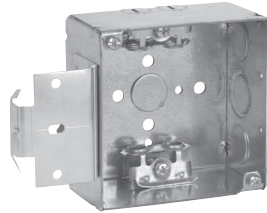

TP450MSB

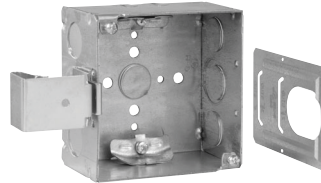

TP450SSB

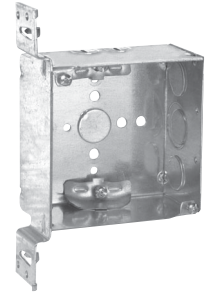

TP452

Cat. #	Bracket	Description	Knockouts		Unit Qty.	Wt. Lbs. Per 100
			Sides	Bottom		
TP450	-	Welded	4 - Cable, 4 - 1/2", 2 - 1/2" + 3/4" E	1 - 1/2"	25	90
TP450MSB	MSB	Welded	4 - Cable, 4 - 1/2", 2 - 1/2" + 3/4" E	1 - 1/2"	25	101
TP450SSB	SSB	Welded	4 - Cable, 4 - 1/2", 2 - 1/2" + 3/4" E	1 - 1/2"	25	101
TP452	"VMS"	Welded	4 - Cable, 2 - 1/2", 1 - 1/2" + 3/4" E	1 - 1/2"	25	104

4" SQUARE OUTLET BOXES – 30.3 CUBIC INCH CAPACITY

2 1/8" DEEP
FOR ARMoured & METAL-CLAD (MCI) CABLE & HCF CABLE – CLAMPS IN EACH END
UL LISTED

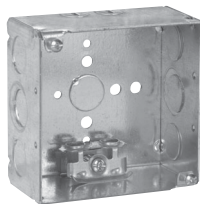

TP431

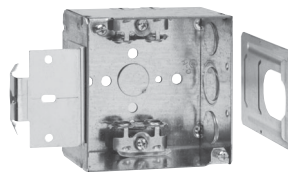

TP431MSB

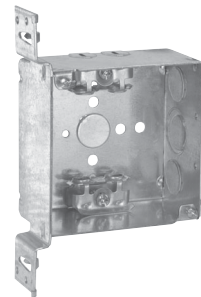

TP440

Cat. #	Metal Stud Sizes	Bracket	Description	Knockouts		Unit Qty.	Wt. Lbs. Per 100
				Sides	Bottom		
TP431*	-	-	Welded	4 - Cable, 4 - 1/2", 2 - 1/2" & 3/4" E	1 - 1/2"	25	91
TP431PF†	-	-	Welded	4 - Cable, 4 - 1/2", 2 - 1/2" & 3/4" E	1 - 1/2"	25	91
TP431MSB	-	MSB	Welded	4 - Cable, 4 - 1/2", 2 - 1/2" & 3/4" E	1 - 1/2"	25	91
TP431SSB*	-	SSB	Welded	4 - Cable, 4 - 1/2", 2 - 1/2" & 3/4" E	1 - 1/2"	25	102
TP440*	All	"VMS"	Welded	4 - Cable, 2 - 1/2", 1 - 1/2" & 3/4" E	1 - 1/2"	25	103

*UL approved for use with aluminum interlocking grounding metal-clad cable, Type MCIA (Southwire MCAP™).

MCAP™ is a registered trademark of Southwire Company.

†TTP catalog numbers ending in PF include ground screw with pigtail lead.

Steel Boxes

Steel Square Boxes

4" SQUARE TWO DEVICE BOXES – 30.3 CUBIC INCH CAPACITY

2 1/8" DEEP – FOR CONDUIT

UL LISTED

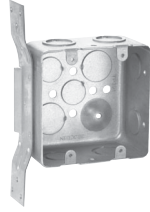

TP391

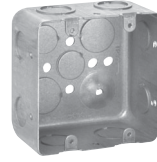

TP395

Cat. #	Bracket	Description	Knockouts		Unit Qty.	Wt. Lbs. Per 100
			Sides	Bottom		
TP391	"VS", Set 7/8"	Drawn	6 - 1/2", 3 - 3/4"	3 - 1/2", 2 - 3/4"	25	95
TP395	-	Drawn	8 - 1/2", 4 - 3/4"	3 - 1/2", 2 - 3/4"	25	84

4" SQUARE OUTLET BOXES – 46.0 CUBIC INCH CAPACITY

3 1/2" DEEP – FOR CONDUIT

UL LISTED, FILE NO. E-15022

Applications:

- 4" square, 3 1/2" deep outlet boxes are ideal for applications requiring increased capacity, including the installation of speaker boxes, fire alarms, strobes, security cameras and other oversized devices
- For use with rigid/IMC and EMT conduit



TP411

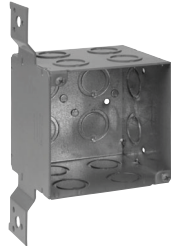

TP411RED

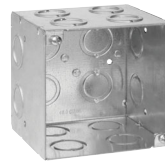

TP413



TP413RED

Cat. #	Bracket	Description	Knockouts		Unit Qty.	Wt. Lbs. Per 100
			Sides	Bottom		
TP411	Side	Welded	12 - 1/2" + 3/4" C	4 - 1/2" + 3/4" C	10	137
TP411RED	Side	Welded	12 - 1/2" + 3/4" C	4 - 1/2" + 3/4" C	10	137
TP413	-	Welded	12 - 1/2" + 3/4" C	4 - 1/2" + 3/4" C	20	125
TP413RED	-	Welded	12 - 1/2" + 3/4" C	4 - 1/2" + 3/4" C	20	125