

**MILBANK**<sup>®</sup>  
ENERGY AT WORK



# Ohio

*Meter Mounting Equipment*



# Milbank Overview

## Energy At Work since 1927

Milbank designs and manufactures electrical solutions that move and manage power for the residential, commercial, industrial, utility and transportation sectors. With 90 years of expertise in electrical engineering design and manufacturing, Milbank's portfolio includes metering equipment, enclosures and enclosed controls. Founded in 1927, Milbank is a family-owned, American manufacturer headquartered in Kansas City, Mo. For more information, please visit [milbankworks.com](http://milbankworks.com).

### METERING



As a market leader in electrical metering equipment, Milbank has set the standard for quality since 1927. Hundreds of configurations are available, including many sizes, knockout configurations, terminal configurations, bypass options, hubs, locks and connectors. Milbank has the socket you need with thousands of active products to meet your utility's requirements.

### ENCLOSURES



Milbank's line of enclosures include commercial junction boxes, panel mount enclosures, transformer cabinets, wireway, trough and industrial panel mount and push-button enclosures. Built with high-quality craftsmanship and materials which meet or exceed industry standards, Milbank enclosures are made to protect controls and equipment from dust, dirt and other harmful elements found in a wide variety of environments.

### ENCLOSED CONTROLS



Milbank doesn't just build empty enclosures. We can deliver the entire package, complete with custom control equipment built to your exact specifications by our engineers. Milbank commercial pedestals are an attractive, secure, easy to install and cost-effective solution when underground remote site power distribution and control equipment is required, replacing unsightly and inefficient strut and backboard structures.



Please consult serving utility for their requirements prior to ordering or installing, as specifications and approvals vary by utility, and may require local electrical inspector approval. All installations must be installed by a licensed electrician and must comply with all national and local codes, laws and regulations. Milbank reserves the right to make changes in specifications and features shown without notice or obligation.

# Table of Contents

## Air Conditioner Disconnects

---

30-60 amp AC disconnects .....	6
60 amp AC disconnect with 20 amp GFCI receptacle .....	7
Hot tub disconnects.....	8

## Single Position Sockets

---

125-200 amps, 4 terminal, ringless .....	9
200 amps, 4, 5 & 7 terminals, lever bypass, ringless .....	10
320 amps, 4 terminal, lever bypass, ringless .....	11
320 amps, 7 terminal, lever, ringless .....	12

## Unmetered Load Centers

---

100-200 amps .....	13
--------------------	----

## Meter Mains

---

100-200 amps, 4 terminals, with load center, ringless.....	14
200 amps, 4 & 7 terminals, lever bypass, ringless .....	15

## Meter Main with Load Center

---

100-200 amps, 4 terminals, with load center, ringless.....	16
--	----

## Meter Mains with Lever Bypass

---

320 amps, 4 & 7 terminals, lever bypass, ringless .....	17-18
---	-------

## Cold Sequence Meter Mains

---

200 & 400 amps, 4, 5 & 7 terminals, ringless.....	19
---	----

## Multi-Position Sockets

---

150 amps, 4 terminals, ringless.....	20
200 amps, 4 terminals, ringless.....	21-22
200 amps, 5 terminals, lever bypass, ringless.....	23
200 amps, 7 terminals, lever bypass, ringless.....	24

## Multi-Position Meter Mains

---

125 & 200 amps, 4 terminals, ringless .....	25-28
---	-------

Please consult serving utility for their requirements prior to ordering or installing, as specifications and approvals vary by utility, and may require local electrical inspector approval. All installations must be installed by a licensed electrician and must comply with all national and local codes, laws and regulations. Milbank reserves the right to make changes in specifications and features shown without notice or obligation.



**Transformer Rated**

20 amps, plunger bypass, ringless & ring type .....	29
20 amps, test switch provision .....	30
80 amps, 6, 8 & 13 terminals, lever bypass .....	31
Test Switches .....	32
Test Switch Worksheet .....	33
Current Transformer Cabinets .....	34

**Pedestals**

100-200 amp, 4 terminal, meter main with load center, ringless.....	35
---	----

**Temporary Power Units**

125 amp, 4 terminal, ringless .....	36
-------------------------------------	----

**Surface & Pedestal Mount Power Outlets**

125 amp, 4 terminal, surface mount .....	37
125 amp, 4 terminal, pedestal mount .....	38

**Miscellaneous**

Terminal Boxes .....	39
Circuit Breaker .....	40-41
Accessories .....	42-45
Commercial Pedestals.....	46-55
Industrial and Commercial Enclosures.....	56
Reference Information .....	57-62
Index.....	63-64



Please consult serving utility for their requirements prior to ordering or installing, as specifications and approvals vary by utility, and may require local electrical inspector approval. All installations must be installed by a licensed electrician and must comply with all national and local codes, laws and regulations. Milbank reserves the right to make changes in specifications and features shown without notice or obligation.

# Catalog Number Logic

How our product catalog numbers are derived

Milbank drawing number

**TG:** Triplex ground  
**QG:** Quadplex ground

Lugs (1Ø or 3Ø,  
350 or 600 kcmil  
Single: **K1, K3, K5, K7**  
Twin: **K2, K4, K6, K8**

Utility specific designation

**U2448-X-QG-5T9-K3-BLG-ARE**

**U:** UL Listed  
**S:** Non-UL Listed  
**UAP:** UL, aluminum, painted

5th terminal designation  
**5T6:** installed at 6:00  
**5T9:** installed at 9:00

**BLG:** Barrel lock / guard provision

### Hub Openings & Closing Plates

<b>-O</b> Blank top	<b>-PXL</b> Closing plate packed inside
<b>-RL</b> Small hub opening	<b>-WL</b> 1" hub
<b>-R</b> Large hub opening	<b>-YL</b> 1¼" hub
<b>-XL</b> Small closing plate	<b>-ZL</b> 1½" hub
<b>-XT</b> (2) Large Closing plates	<b>-DL</b> 2" hub
<b>-XTL</b> (2) Small closing plates	<b>-EL</b> 2½" hub
<b>-X</b> Large closing plate	<b>-F</b> 3" hub
<b>-RXL</b> Large hub opening adapted to small closing plate	<b>-G</b> 3½" hub
<b>-RRL</b> Large hub opening adapted to small hub opening	<b>-H</b> 4" hub

**U:** UL Listed  
**S:** Non-UL Listed  
**UAP:** UL, aluminum, painted

**KK:** Horn bypass

**BL:** Barrel lock

**U7040-RL-TG-KK-5T9-BL-AUT**

Milbank drawing number

**TG:** Triplex ground  
**QG:** Quadplex ground

5th terminal designation  
**5T6:** installed at 6:00  
**5T9:** installed at 9:00

Utility specific designation

Please consult serving utility for their requirements prior to ordering or installing, as specifications and approvals vary by utility, and may require local electrical inspector approval. All installations must be installed by a licensed electrician and must comply with all national and local codes, laws and regulations. Milbank reserves the right to make changes in specifications and features shown without notice or obligation.



# Air Conditioner Disconnects

30-60 Amps | Fusible & Non-Fusible



**U3802**



**U3812**



**U3832**

Milbank's air conditioner disconnect has a removable hinged cover for ease of installation. Our compact design meets NEC wiring space requirements and also complies with NEC article 440-14. For safe working conditions, our disconnect pullers may be removed and reinstalled in the OFF position. Additionally, padlock provisions are included on the front cover. As with other Milbank products, our enclosure is constructed of G90U galvanized steel and electrostatically finished with an attractive, light gray, baked powder coating. Our epoxy/polyester resin blend offers a finish that is both durable and fade-resistant.

## 30-60 Amps | 1Ø 240 VAC | Air Conditioner Disconnects

Catalog Number	Amps	Type	Max H.P.	Weight (lbs.)	Line/Load Wire Range		Ground Wire Range CU/AL	Dimensions			Wire Rating	
					CU	AL		D"	W"	H"	CU °C	AL °C
<b>U3802</b>	60	Non-Fusible	10	3.25	#14-#2	#12-#2	#14-4	2½	5	7½	60°/75°	60°/75°
<b>U3812</b>	60	Non-Auto	10	3.25	#14-#2	#12-#2	#14-4	2½	5	7½	60°/75°	60°/75°
<b>U3832</b>	30	Fusible	3	2.5	#14-#3	#14-#3	#14-3	2½	5	7	60°/75°	60°/75°
<b>U3862</b>	60	Fusible	10	3.3	#14-#3	#14-#3	#14-3	2½	5	9	60°/75°	60°/75°

### Notes

- UL listed as Enclosed Pullout Switch
- Type 3R rain-resistant
- One-inch concentric knockouts



Please consult serving utility for their requirements prior to ordering or installing, as specifications and approvals vary by utility, and may require local electrical inspector approval. All installations must be installed by a licensed electrician and must comply with all national and local codes, laws and regulations. Milbank reserves the right to make changes in specifications and features shown without notice or obligation.

# Air Conditioner Disconnects

## 20 Amp GFCI Receptacle



U3822-20GWR

### Specifications

- Meets NEC #210.63 requirements
- UL listed as Power Outlet
- Type 3R enclosure
- In-use cover\*
- Duplex ground connector
- 1" concentric knockouts
- 1Ø, 240 volt
- 60 amp, non-fused
- 20 amp GFCI receptacle
- Reset/test button
- Weather and tamper resistant
- Meets NEC #406.8 requirements

### 60 Amps | 1Ø, 240 VAC | Air Conditioner Disconnect with GFCI Receptacle

Catalog Number	Type	Max H.P.	Weight (lbs.)	Line/Load Wire Range		Ground Wire Range CU/AL	Dimensions			Wire Rating	
				CU	AL		D"	W"	H"	CU °C	AL °C
U3822-20GWR	Non-Fusible	10	6	#14-#2	#12-#2	#14-4	4 $\frac{1}{8}$ "	5 $\frac{1}{4}$ "	7 $\frac{1}{2}$ "	60°/75°	60°/75°

### Notes

- **Disconnect Pullers:** To ensure the safest conditions, Milbank disconnect pullers are reversible so they may be reinstalled in the OFF position.
- **Padlock Provision:** All units are designed with a padlock provision on the cover for security.
- **\*In-Use Cover:** Cover is rated as an in-use cover (cover may be closed with cords plugged into receptacle).

Please consult serving utility for their requirements prior to ordering or installing, as specifications and approvals vary by utility, and may require local electrical inspector approval. All installations must be installed by a licensed electrician and must comply with all national and local codes, laws and regulations. Milbank reserves the right to make changes in specifications and features shown without notice or obligation.



# Hot Tub Disconnects

## Type 3R Enclosures



**U4881-O-50GB**



**U4881-O-60GB**

### Specifications

- 240 volt ground fault protection
- UL listed, Type 3R rain-resistant
- 2-pole, 50 or 60 amp GFCI breaker protection
- Compact size
- Three or four wire installation
- 1Ø, 120/240 VAC
- Standard package of 12
- Two extra one-pole breaker spaces
- 100 amp overall rating
- Easy to install

### 100 Amps | Hot Tub Disconnect or Sub Panel Breaker Enclosure | Type 3R

Catalog Number	Breaker Amps	Type	Weight (lbs.)	Line/Load Wire Range		Ground Wire Range CU/AL	Dimensions		
				CU	AL		D"	W"	H"
<b>U4881-O-50GB</b>	50	Breaker	8	#14-1/0	#14-1/0	#14-1/0	3¾	7½	8½
<b>U4881-O-60GB</b>	60	Breaker	8	#14-1/0	#14-1/0	#14-1/0	3¾	7½	8½



Please consult serving utility for their requirements prior to ordering or installing, as specifications and approvals vary by utility, and may require local electrical inspector approval. All installations must be installed by a licensed electrician and must comply with all national and local codes, laws and regulations. Milbank reserves the right to make changes in specifications and features shown without notice or obligation.



# Single Position Sockets

4 Terminal | 125-200 Amp | Ringless | 600 VAC

9

125-200 AMP  
SINGLE  
POSITION



U7487-RL-TG-KK

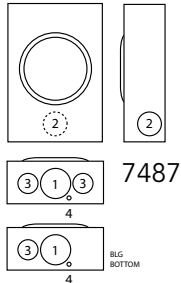

U7040-RL-TG-KK

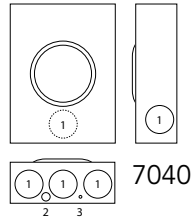

U4532-XL

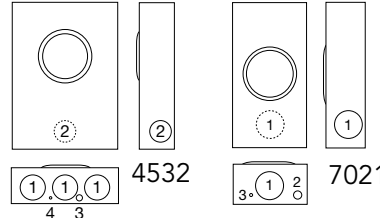

U1980-O-KK

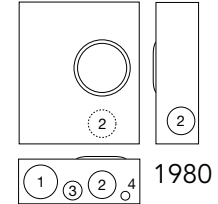

## 4 Terminal | Single Position | Ringless | 1Ø3W

Catalog Number	Amps	Service	Hub	Connectors CU/AL			Bypass	Dimensions			Knockouts			
				Line	Load			D"	W"	H"	1	2	3	4
U7487-RL-TG-KK	125	OH/UG	H.O.	#6-2/0	#6-2/0	Horn	3 <sup>5</sup> / <sub>16</sub>	8	11 <sup>1</sup> / <sub>2</sub>	2	1 <sup>1</sup> / <sub>2</sub>	1 <sup>1</sup> / <sub>4</sub>	1 <sup>1</sup> / <sub>4</sub>	
U7487-RL-TG-KK-BLG	125	OH/UG	H.O.	#6-2/0	#6-2/0	Horn	3 <sup>5</sup> / <sub>16</sub>	8	11 <sup>1</sup> / <sub>2</sub>	2	—	1 <sup>1</sup> / <sub>4</sub>	1 <sup>1</sup> / <sub>4</sub>	
U7021-RL-TG-KK	200	OH	H.O.	#6-350	#6-350	Horn	4 <sup>1</sup> / <sub>8</sub>	8	15 <sup>1</sup> / <sub>2</sub>	2 <sup>1</sup> / <sub>2</sub>	1 <sup>1</sup> / <sub>4</sub> , 1 <sup>1</sup> / <sub>2</sub>	1 <sup>1</sup> / <sub>4</sub>	—	
U7021-RL-TG-KK-BLG	200	OH	H.O.	#6-350	#6-350	Horn	4 <sup>1</sup> / <sub>8</sub>	8	15 <sup>1</sup> / <sub>2</sub>	2 <sup>1</sup> / <sub>2</sub>	1 <sup>1</sup> / <sub>4</sub> , 1 <sup>1</sup> / <sub>2</sub>	1 <sup>1</sup> / <sub>4</sub>	—	
U7040-RL-TG-KK	200	OH/UG	H.O.	#6-350	#6-350	Horn	4 <sup>1</sup> / <sub>8</sub>	11	14 <sup>5</sup> / <sub>8</sub>	2 <sup>1</sup> / <sub>2</sub>	1 <sup>1</sup> / <sub>4</sub> , 1 <sup>1</sup> / <sub>2</sub>	1 <sup>1</sup> / <sub>4</sub>	—	
U7040-RL-TG-KK-BLG	200	OH/UG	H.O.	#6-350	#6-350	Horn	4 <sup>1</sup> / <sub>8</sub>	11	14 <sup>5</sup> / <sub>8</sub>	2 <sup>1</sup> / <sub>2</sub>	1 <sup>1</sup> / <sub>4</sub> , 1 <sup>1</sup> / <sub>2</sub>	1 <sup>1</sup> / <sub>4</sub>	—	
U7040-XL-TG-KK	200	OH/UG	C.P.	#6-350	#6-350	Horn	4 <sup>1</sup> / <sub>8</sub>	11	14 <sup>5</sup> / <sub>8</sub>	2 <sup>1</sup> / <sub>2</sub>	1 <sup>1</sup> / <sub>4</sub> , 1 <sup>1</sup> / <sub>2</sub>	1 <sup>1</sup> / <sub>4</sub>	—	
U4532-XL	200	OH/UG	C.P.	#6-350	(2) #6-350	None	4 <sup>1</sup> / <sub>8</sub>	15	20 <sup>1</sup> / <sub>2</sub>	3	2 <sup>1</sup> / <sub>2</sub>	1 <sup>1</sup> / <sub>4</sub> , 1 <sup>1</sup> / <sub>2</sub>	1 <sup>1</sup> / <sub>4</sub>	

## 200 Amp | 4 Terminal | Single Position | Ringless | Side Wireway | 1Ø3W

Catalog Number	Service	Hub	Connectors CU/AL			Bypass	Dimensions			Knockouts			
			Line	Load			D"	W"	H"	1	2	3	4
U1980-O-KK	UG	Blank	#6-350	#6-350	Horn	4 <sup>1</sup> / <sub>2</sub>	13	15 <sup>1</sup> / <sub>4</sub>	3	2 <sup>1</sup> / <sub>2</sub>	1 <sup>1</sup> / <sub>2</sub>	1 <sup>1</sup> / <sub>4</sub> , 1 <sup>1</sup> / <sub>2</sub>	
U1980-O-KK-BLG	UG	Blank	#6-350	#6-350	Horn	4 <sup>1</sup> / <sub>2</sub>	13	15 <sup>1</sup> / <sub>4</sub>	3 <sup>1</sup> / <sub>2</sub>	2 <sup>1</sup> / <sub>2</sub>	1 <sup>1</sup> / <sub>2</sub>	1 <sup>1</sup> / <sub>4</sub> , 1 <sup>1</sup> / <sub>2</sub>	

## Notes

- **Hubs:** Order hubs separately — see accessory page for ordering information.
- **Fifth Terminal:** For field mounted fifth terminal for **U7021**, **U7040**, **U4532** and **U1980**, order catalog number **K5T**. For the **U7487**, order catalog number **5T8K2**.
- **Connectors:** Extruded aluminum connectors are tin plated.
- **U4532:** Includes twin lug connector on load side.
- **Tap Connector:** For tap connector, order **K4977-INT**.
- **Product numbers with BLG are used in AEP service areas**

Please consult serving utility for their requirements prior to ordering or installing, as specifications and approvals vary by utility, and may require local electrical inspector approval. All installations must be installed by a licensed electrician and must comply with all national and local codes, laws and regulations. Milbank reserves the right to make changes in specifications and features shown without notice or obligation.



# Single Position Lever Bypass

4, 5 & 7 Terminal | 200 Amp | Ringless | 600 VAC



**U3278-RL**



**U9551-RRL**



**U9701-RRL**

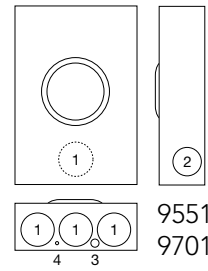
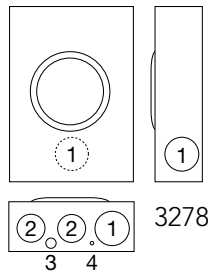

**200 Amp | Single Position | Lever Bypass | Ringless | Non-Jaw Clamping**

Catalog Number	Terminal	Phase	Service	Hub	Connectors CU/AL	Dimensions			Knockouts			
						D"	W"	H"	1	2	3	4
U3278-RL	4	1Ø3W	OH	H.O.	#6-350	4 <sup>7</sup> / <sub>8</sub>	11	15 <sup>1</sup> / <sub>2</sub>	2 <sup>1</sup> / <sub>2</sub>	2	1 <sup>1</sup> / <sub>4</sub> , 1 <sup>1</sup> / <sub>2</sub>	1 <sup>1</sup> / <sub>4</sub>

**200 Amp | Single Position | Heavy Duty Lever Bypass | Ringless | Jaw Clamping**

Catalog Number	Terminal	Phase	Service	Hub	Connectors CU/AL	Dimensions			Knockouts			
						D"	W"	H"	1	2	3	4
U9551-RRL	5	1Ø3W or 3Ø3W	OH/UG	H.O.	#6-350	4 <sup>7</sup> / <sub>8</sub>	13	19	3	2 <sup>1</sup> / <sub>2</sub>	1 <sup>1</sup> / <sub>4</sub> , 1 <sup>1</sup> / <sub>2</sub>	1 <sup>1</sup> / <sub>4</sub>
U9701-RRL	7	3Ø4W	OH/UG	H.O.	#6-350	4 <sup>7</sup> / <sub>8</sub>	13	19	3	2 <sup>1</sup> / <sub>2</sub>	1 <sup>1</sup> / <sub>4</sub> , 1 <sup>1</sup> / <sub>2</sub>	1 <sup>1</sup> / <sub>4</sub>
U9701-RRL-BLG	7	3Ø4W	OH/UG	H.O.	#6-350	4 <sup>7</sup> / <sub>8</sub>	13	19	3	2 <sup>1</sup> / <sub>2</sub>	1 <sup>1</sup> / <sub>4</sub> , 1 <sup>1</sup> / <sub>2</sub>	1 <sup>1</sup> / <sub>4</sub>

**Notes**

- **Hubs:** For proper hub selection, see the hub suffix chart on the accessory page.
- **Connectors:** Extruded aluminum connectors are tin plated.
- **Bypass:** The lever on the **U3278** unit operates the bypass device only; it does not provide clamping action on the meter spades. The levers on the **U9551** and **U9701** units supply clamping action on meter spades and also operate the bypass devices.
- **Product numbers with BLG are used in AEP service areas**



Please consult serving utility for their requirements prior to ordering or installing, as specifications and approvals vary by utility, and may require local electrical inspector approval. All installations must be installed by a licensed electrician and must comply with all national and local codes, laws and regulations. Milbank reserves the right to make changes in specifications and features shown without notice or obligation.

# Single Position Lever Bypass

320 Amp | 4 Terminal | Ringless | 600 VAC

**1 1**  
320 AMP  
SINGLE  
POSITION  
LEVER BYPASS



U4363-X-QG-K3-K2

U1079-RRL-K3

U1129-O-K3L-K2L

U1797-O-K3L-K2L

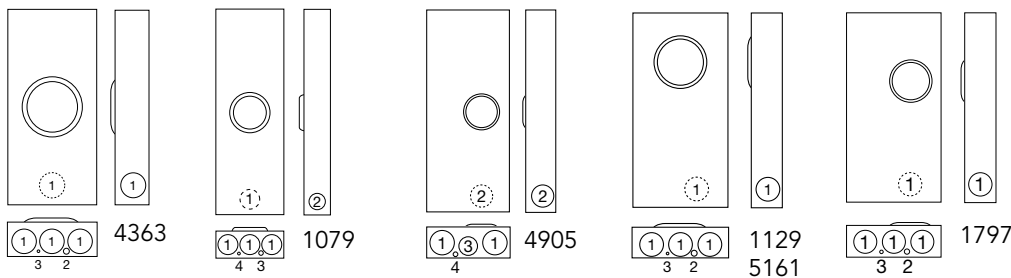

320 Amp Continuous (400 Amp Max) | 4 Terminal | Single Position | Ringless | 1Ø3W

Catalog Number	Service	Hub	Connectors CU/AL		Bypass	Dimensions			Knockouts			
			Line	Load		D"	W"	H"	1	2	3	4
U4363-X-QG-K3-K2	OH	C.P.	(1) #4-600 or (2) 1/0-250	(2)#6-350	Lever	4 <sup>7</sup> / <sub>8</sub>	13	28 <sup>1</sup> / <sub>4</sub>	3	1/4, 1/2	1/4	—
U1079-RRL-K3	OH	H.O.	(1) #4-600 or (2) 1/0-250	3/8" x 16 Studs	Lever	4 <sup>7</sup> / <sub>8</sub>	13	38 <sup>3</sup> / <sub>4</sub>	3	2 <sup>1</sup> / <sub>2</sub>	1/4, 1/2	1/4
U4905-X	OH/UG	C.P.	3/8" x 16 Studs	3/8" x 16 Studs	Lever	5 <sup>3</sup> / <sub>4</sub>	16	38 <sup>3</sup> / <sub>4</sub>	4	3 <sup>1</sup> / <sub>2</sub>	3	1/4, 1/2
U4905-X-BLG	OH/UG	C.P.	3/8" x 16 Studs	3/8" x 16 Studs	Lever	5 <sup>3</sup> / <sub>4</sub>	16	38 <sup>3</sup> / <sub>4</sub>	4	3 <sup>1</sup> / <sub>2</sub>	3	1/4, 1/2
U1129-O-K3L-K2L	UG	Blank	(1) #4-600 or (2) 1/0-250	(2) #6-350	Lever	4 <sup>7</sup> / <sub>8</sub>	15	30	3	1/4, 1/2	1/4	—
U5161-X-K3L-K2L-BLG	OH/UG	C.P.	(1) #4-600 or (2) 1/0-250	(2) #6-350	Lever	4 <sup>7</sup> / <sub>8</sub>	15	30	3	1/2	1/4	—
U1797-O-K3L-K2L	UG	Blank	(1) #4-600 or (2) 1/0-250	(2) #6-350	Lever	4 <sup>7</sup> / <sub>8</sub>	15	30	3	1/4, 1/2	1/4	—
U1797-O-K3L-K2L-BLG	UG	Blank	(1) #4-600 or (2) 1/0-250	(2) #6-350	Lever	4 <sup>7</sup> / <sub>8</sub>	15	30	3	1/4, 1/2	1/4	—

## Notes

- **Side Wireway:** U1797 and U4905 are side wireway units.
- **Bypass:** Lever supplies clamping action and also operates bypass device.
- **Hubs:** For proper hub selection, see the hub suffix chart on the accessory page.
- **Connectors:** Supplied with 3/8" x 16 hex head nuts with Belleville washers. For connector kits, order as extra **K1540** (single 600 kcmil). For twin lug connectors, order as extra **K1350** (twin 350 kcmil). Order two kits to cover both line and load on **U4905** and one kit for load side of **U1079**.
- **Fifth Terminal:** For factory-installed fifth terminal in the 6 o'clock position, add the suffix **-5T6** to the catalog number. For factory-installed fifth terminal in the 9 o'clock position, add the suffix **-5T9** to the catalog number. For field-installed fifth terminal, order as extra catalog number **K3865** for **U1129**, **U1797** and **U4905** and **K3866** for **U1079**.
- **Product numbers with BLG are used in AEP service areas**

Please consult serving utility for their requirements prior to ordering or installing, as specifications and approvals vary by utility, and may require local electrical inspector approval. All installations must be installed by a licensed electrician and must comply with all national and local codes, laws and regulations. Milbank reserves the right to make changes in specifications and features shown without notice or obligation.



# Single Position Lever Bypass

320 Amp | 7 Terminal | Ringless | 600 VAC



U2120-X-K7

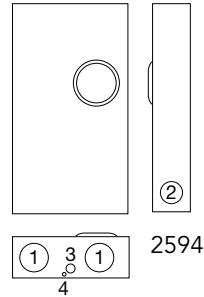
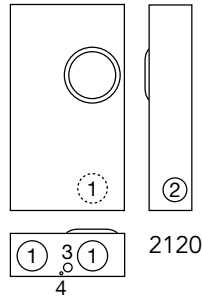

U2594-X

320 Amp | 7 Terminal | Single Position | Ringless | Side Wireway | 3Ø4W

Catalog Number	Service	Hub	Connectors CU/AL		Bypass	Dimensions			Knockouts			
			Line	Load		D"	W"	H"	1	2	3	4
U2594-X	OH/UG	C.P.	3/8" x 16 Studs	3/8" x 16 Studs	Lever	6 1/2	19	34 1/8	4	3	1	1/4
U2594-X-K7-K6-BLG	OH/UG	C.P.	3/8" x 16 Studs	3/8" x 16 Studs	Lever	6 1/2	19	34 1/8	4	3	1	1/4
U2594-X-BLG	OH/UG	C.P.	3/8" x 16 Studs	3/8" x 16 Studs	Lever	6 1/2	19	34 1/8	4	3	1	1/4
U2120-X-K7	UG	C.P.	(1) #4-600 or (2) 1/0-250	3/8" x 16 Studs	Lever	6 1/2	17 3/4	31 3/4	4	3	1	1/4

## Notes

- **Hubs:** For proper hub selection, see the hub suffix chart on the accessory page.
- **Bypass:** Lever supplies clamping action and also operates bypass device.
- **Connectors:** Supplied with 3/8" x 16 hex head nuts with Belleville washers. For connector kits, order as extra **K3441** (single 600 kcmil). For twin lug connectors, order as extra **K3442** (twin 350 kcmil). Separate kits are required for both line and load. Line side connectors furnished on **U2120**.
- **Product numbers with BLG are used in AEP service areas.**



Please consult serving utility for their requirements prior to ordering or installing, as specifications and approvals vary by utility, and may require local electrical inspector approval. All installations must be installed by a licensed electrician and must comply with all national and local codes, laws and regulations. Milbank reserves the right to make changes in specifications and features shown without notice or obligation.

# Unmetered Load Centers

200 Amp | 120/240 VAC

**13**  
200 AMP  
UNMETERED  
LOAD CENTERS



USE-22-200-MB

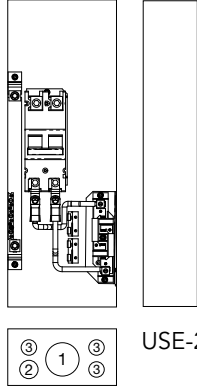

USE-22



U5971-XL-200

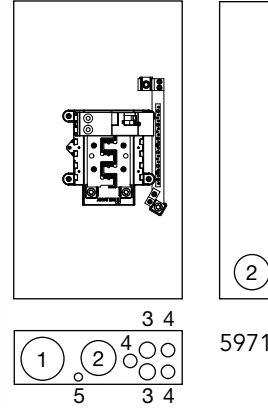

U5971

## 200 Amp | Unmetered Load Center with Main Breaker

Catalog Number	Main Breaker Amp	Circuits	Service	Hub	Dimensions			Knockouts				
					D"	W"	H"	1	2	3	4	5
USE-22-200-MB	200	4	OH	2"	4	8	23	2	1	1/2, 3/4	—	—
U5971-XL-100	100	10	OH/UG	C.P.	4 1/2	14 1/8	25 1/6	3	2	1	1/2, 3/4	1/4, 1/2
U5971-XL-150	150	8	OH/UG	C.P.	4 1/2	14 1/8	25 1/6	3	2	1	1/2, 3/4	1/4, 1/2
U5971-XL-200	200	8	OH/UG	C.P.	4 1/2	14 1/8	25 1/6	3	2	1	1/2, 3/4	1/4, 1/2

## Notes

- **AIC Rating:** This units are rated 22K AIC.
- **Breaker Interlock:** U5971 accepts breaker interlock kits — order **K5815** for large QN with small frame Q, **K5820** for large frame QN with large frame QN, or **K5830** for small frame Q to small frame Q.

Please consult serving utility for their requirements prior to ordering or installing, as specifications and approvals vary by utility, and may require local electrical inspector approval. All installations must be installed by a licensed electrician and must comply with all national and local codes, laws and regulations. Milbank reserves the right to make changes in specifications and features shown without notice or obligation.





U3989-XL

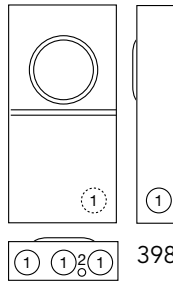

3989



U3491-XL-200

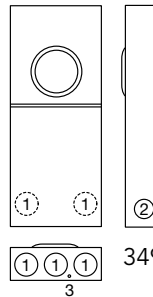

3491



U5844-PXL-200-KK

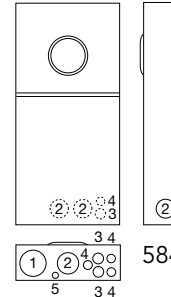

5844

4 Terminal | Meter Mains | Ringless | 1Ø3W

Catalog Number	Service	Amp	Hub	Connectors CU/AL		Bypass	Dimensions			Knockouts				
				Line	Load		D"	W"	H"	1	2	3	4	5
U3989-XL	OH/UG	125	C.P.	#6-2/0	CB	None	3¾	11	22	2	¼, ½	—	—	—
U5844-PXL-200-KK	OH/UG	200	C.P.	#6-350	CB	Horn	4½	14	30	3	2½	1	½, ¾	¼, ½
U5844-PXL-200-KK-BLG	OH/UG	200	C.P.	#6-350	CB	Horn	4½	14	30	3	2½	1	½, ¾	¼, ½

### Notes

- **Hubs:** For proper hub selection, see the hub suffix chart on the accessory page.
- **Breaker:** For replacement breakers for **U3491**, order **UQFB-200-X1**; for **U5844** order **QN2200H**. For **U3989**, order approved small frame breakers 125 amps or less per the rating label.
- **Fifth Terminal:** For field installable fifth terminal kit, order **K5T**.
- **AIC Rating:** The **U5844** is 22K AIC rated.
- **PXL** - Closing plate packed inside of carton.
- **Product numbers with BLG are used in AEP service areas.**



Please consult serving utility for their requirements prior to ordering or installing, as specifications and approvals vary by utility, and may require local electrical inspector approval. All installations must be installed by a licensed electrician and must comply with all national and local codes, laws and regulations. Milbank reserves the right to make changes in specifications and features shown without notice or obligation.

# Meter Mains

200 Amp | 4 & 7 Terminal | Lever Bypass | Ringless

**15**  
200 AMP  
LEVER BYPASS  
METER MAINS

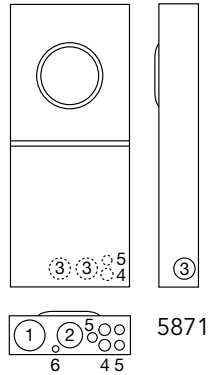

U5871-XL-200

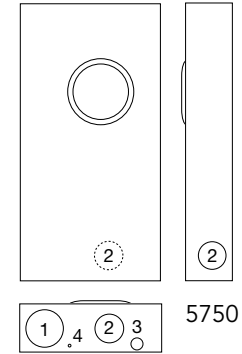

U5750-RXL-200-BL

## 200 Amp | Meter Main | Lever Bypass | Ringless

Catalog Number	Terminals	Breaker Amps	Service	Hub	Connectors CU/AL - Line	Dimensions			Knockouts					
						D"	W"	H"	1	2	3	4	5	6
U5871-XL-200	4	200	OH/UG	C.P.	#6-350	4½	14⅞	32	3	2½	2	1	½,¾	¼,½
U5750-RXL-200-BL	7	200	OH/UG	C.P.	#6-350	5¾	17¾	34	4	3	1	¼	—	—

### Notes

- **Breakers:** U5871 is rated 22K AIC with QNR2200H main installed. U5750 is rated 10K AIC with UQFB-3200 main installed.
- **-BL:** Barrel lock
- **Fifth Terminal:** For field installed fifth terminal for U5871, order K5T.
- **Interlock Kit:** For generator auxiliary circuit breaker interlock for U5871, order K5815 for large QN with small frame Q; order K5820 for large frame QN with large frame QN.

Please consult serving utility for their requirements prior to ordering or installing, as specifications and approvals vary by utility, and may require local electrical inspector approval. All installations must be installed by a licensed electrician and must comply with all national and local codes, laws and regulations. Milbank reserves the right to make changes in specifications and features shown without notice or obligation.



# 16

200 AMP  
METER MAIN  
WITH LOAD  
CENTER

# Meter Main With Load Center

200 Amp | 4 Terminal | Ringless | 120/240 VAC



U5168-XTL-200-KK

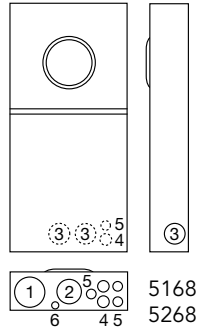

U5268-XTL-200-KK

Knockouts					
1	2	3	4	5	6
3	2½	2	1	½, ¾	¼, ½

200 Amp | 4 Terminal | Meter Mains | Horn Bypass | Ringless | 1Ø3W

Catalog Number	Breaker Amps	Circuits	Service	Hub	Connectors CU/AL - Line	Dimensions		
						D"	W"	H"
U5168-XTL-100-KK	100	10	OH/UG	C.P.	#6-350	4½	14⅞	32
U5168-XTL-100-KK-BLG	100	10	OH/UG	C.P.	#6-350	4½	14⅞	32
U5168-XTL-150-KK	150	8	OH/UG	C.P.	#6-350	4½	14⅞	32
U5168-XTL-150-KK-BLG	150	8	OH/UG	C.P.	#6-350	4½	14⅞	32
U5168-XTL-200-KK	200	8	OH/UG	C.P.	#6-350	4½	14⅞	32
U5168-XTL-200-KK-BLG	200	8	OH/UG	C.P.	#6-350	4½	14⅞	32
U5268-XTL-150-KK	150	20	OH/UG	C.P.	#6-350	4½	14⅞	32
U5268-XTL-200-KK	200	20	OH/UG	C.P.	#6-350	4½	14⅞	32
U5268-XTL-200-KK-BLG	200	20	OH/UG	C.P.	#6-350	4½	14⅞	32

## Notes

- **Fifth Terminal:** For field installed fifth terminal, order **K5T**.
- **Breakers:** Rated 22K AIC with **QN2200H** main installed for **U5168** and **U5268**.
- **Sub Feed Lugs:** #6-350 sub feed lugs provided on 8 circuit interior. **Not available on 20 circuit interior.**
- **Main Lug Kit:** Main lug feed-through kit **K3701** available.
- **XTL -** Two small hub closing plate.
- **Product numbers with BLG are used in AEP service areas**

**Generator Interlock — for use with U5168 and U5268**

	K5815	K5820	K5830
	Large QN with small frame Q	Large frame QN with large frame QN	Small frame Q to small frame Q

## Branch Breaker Chart

AIC Rating	Amps	Siemens	Cutler Hammer	General Electric	Square D
10k	150-200	QNR	BR (150A only)	—	—
	≤ 125	QP	HQP, BR	THQL, THQL-GF	Homeline
22k	150-200	QNRH	—	—	—
	≤ 125	QPH	—	—	—



Please consult serving utility for their requirements prior to ordering or installing, as specifications and approvals vary by utility, and may require local electrical inspector approval. All installations must be installed by a licensed electrician and must comply with all national and local codes, laws and regulations. Milbank reserves the right to make changes in specifications and features shown without notice or obligation.



# Lever Bypass Meter Mains

320 Amp | 4 Terminal | Ringless | 120/240 VAC

**17**  
320 AMP  
LEVER BYPASS  
METER MAINS



U5059-X-2/200



U5890-X-2/200-BL  
(shown with lugs installed)



U5891-X-2/200-MLK-BL

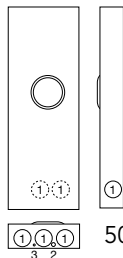

5059

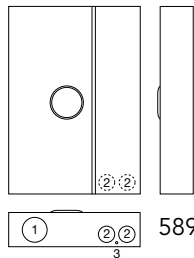

5890

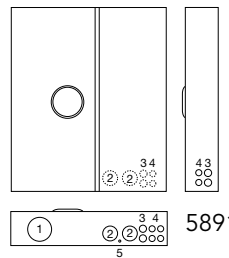

5891

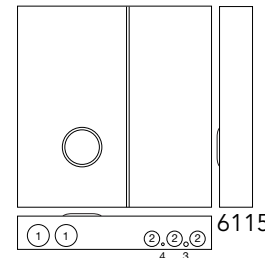

6115

320 Amp | 4 & 7 Terminal | Meter Mains | Lever Bypass | Ringless

Catalog Number	Terms.	Service	Hub	Connectors CU/AL - Line	Breaker Amps	Branch Circuits	Dimensions			Knockouts				
							D"	W"	H"	1	2	3	4	5
U5059-X-K3L	4	OH/UG	C.P.	(1) #4-600 or (2) 1/0-250	Provision	N/A	4 <sup>7</sup> / <sub>8</sub>	15	42	3	1/4, 1/2	1/4	—	—
U5059-X-2/200-K3L	4	OH/UG	C.P.	(1) #4-600 or (2) 1/0-250	200	N/A	4 <sup>7</sup> / <sub>8</sub>	15	42	3	1/4, 1/2	1/4	—	—
U5890-X-2/200-BL*	4	OH/UG	C.P.	3/8" x 16 Studs	200	N/A	6	24 <sup>1</sup> / <sub>2</sub>	35	4	2 <sup>1</sup> / <sub>2</sub>	1/4	—	—
U5890-X-2/200-BLG	4	OH/UG	C.P.	3/8" x 16 Studs	200	N/A	6	24 <sup>1</sup> / <sub>2</sub>	35	4	2 <sup>1</sup> / <sub>2</sub>	1/4	—	—
U5891-X-2/200-MLK-BL*	4	OH/UG	C.P.	3/8" x 16 Studs	200	12	6	29 <sup>1</sup> / <sub>2</sub>	35	4	2 <sup>1</sup> / <sub>2</sub>	1	1/2, 3/4	1/4
U6115-X-2/200-K7L**	7	OH/UG	C.P.	#4-600 kcmil or (2) 1/0-250	200	N/A	7	34 <sup>1</sup> / <sub>4</sub>	34	4	2 <sup>1</sup> / <sub>2</sub>	1/2	1/4	—

## Notes

- **AIC Rating:** 22K AIC standard.
- **Breakers:** For U5059 main breakers, order UQFPH-100, -150, or -200.
- **-MLK:** Main Lug feed-through kit K3701 factory installed.
- **Fifth Terminal:** For field mounted fifth terminal order catalog number K3865.
- Supplied with 3/8" x 16 hex head nuts with Belleville washers. For connector kits, order as extra K1540 (single 600 kcmil). For twin lug connectors, order as extra K1350 (twin 350 kcmil). The Extra stud on line side is a wire stop
- \* Barrel lock (suffix -BL).
- \*\*7 Terminal 3-phase 4-wire.
- **Product numbers with BLG are used in AEP service areas.**

Please consult serving utility for their requirements prior to ordering or installing, as specifications and approvals vary by utility, and may require local electrical inspector approval. All installations must be installed by a licensed electrician and must comply with all national and local codes, laws and regulations. Milbank reserves the right to make changes in specifications and features shown without notice or obligation.



# Lever Bypass Meter Mains **with 400A Breaker**

320 Amp | 4 & 7 Terminal | Ringless | Jaw Clamping

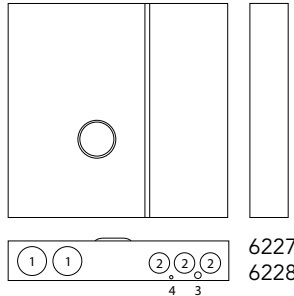

U6228-X-400-K3

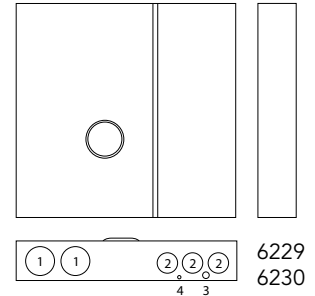

U6230-X-400-K7

## 320 Amp | 4 Terminal | Meter Mains | Lever Bypass | Ringless

Catalog Number	Service	Hub	Connectors CU/AL	Dimensions			Knockouts			
			Line	D"	W"	H"	1	2	3	4
U6227-X-400-k3	OH/UG	C.P.	600 kcmil	6	36¼	34	4	2½	½	¼
*U6228-X-400-K3	OH/UG	C.P.	600 kcmil	6	36¼	34	4	2½	½	¼

## 320 Amp | 7 Terminal | Meter Mains | Lever Bypass | Ringless

Catalog Number	Service	Hub	Connectors CU/AL	Dimensions			Knockouts			
			Line	D"	W"	H"	1	2	3	4
U6229-X-400-K7	OH/UG	C.P.	600 kcmil	6	36¼	34	4	2½	½	¼
*U6230-X-400-K7	OH/UG	C.P.	600 kcmil	6	36¼	34	4	2½	½	¼

### Notes

- **Short Circuit Current Rating:** 22K AIC at 120/240 Volts or 10K at 480 Volts.
- \***Side Bussing:** U6228 and U6230 have side bussing.



Please consult serving utility for their requirements prior to ordering or installing, as specifications and approvals vary by utility, and may require local electrical inspector approval. All installations must be installed by a licensed electrician and must comply with all national and local codes, laws and regulations. Milbank reserves the right to make changes in specifications and features shown without notice or obligation.

# Cold Sequence Meter Mains

4, 5 & 7 Terminal | Ringless



U5767-X-200-CB



U5787-O-200-CB

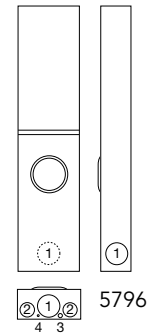

5796

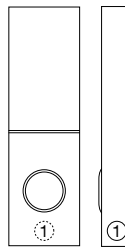

5764 5767  
3 2 5765

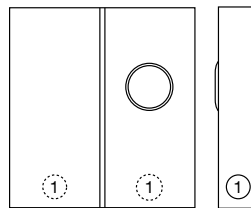

5784 5787

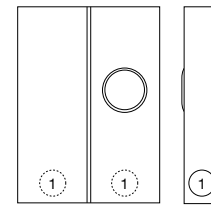

5797 5799

## 200 Amp Circuit Breaker Disconnect Ahead Of Meter Socket | Lever Bypass

Catalog Number	Terminals	Service	Hub	Connectors CU/AL - Load	Phase	Dimensions			Knockouts			
						D"	W"	H"	1	2	3	4
U5764-X-200-CB	4	OH/UG	C.P.	#6-350	1Ø3W	4 <sup>27/32</sup>	13	43	4	2½	¼	—
U5765-X-200-CB	5	OH/UG	C.P.	#6-350	1Ø3W or 3Ø3W	4 <sup>27/32</sup>	13	43	4	2½	1	½, ¾
U5784-O-200-CB	5	UG	Blank	#6-350	1Ø3W or 3Ø3W	4 <sup>27/32</sup>	26	28	4	2½	¼	—
U5767-X-200-CB	7	OH/UG	C.P.	#6-350	3Ø4W	4 <sup>27/32</sup>	13	43	4	2½	1	½, ¾
U5787-O-200-CB	7	UG	Blank	#6-350	3Ø4W	6	26	28	4	2½	1	½, ¾

## 400 Amp (320 Amp Continuous) Circuit Breaker Disconnect Ahead Of Meter Socket | Lever Bypass

Catalog Number	Terminals	Service	Hub	Connectors CU/AL - Load	Phase	Dimensions			Knockouts			
						D"	W"	H"	1	2	3	4
U5797-O-400-CB	5	UG	Blank	3/0-500	1Ø3W or 3Ø3W	6	26	36	4	2½	1	½, ¾
U5796-X-400-CB	7	OH/UG	C.P.	3/0-500	3Ø4W	6	13	56	4	2½	¼	—
U5799-O-400-CB	7	UG	Blank	3/0-500	3Ø4W	6	26	36	4	2½	1	½, ¾

### Notes

- **Hubs:** For proper hub selection, refer to the hub suffix chart on the accessories page.

Please consult serving utility for their requirements prior to ordering or installing, as specifications and approvals vary by utility, and may require local electrical inspector approval. All installations must be installed by a licensed electrician and must comply with all national and local codes, laws and regulations. Milbank reserves the right to make changes in specifications and features shown without notice or obligation.



# Multi-Position Sockets

150 Amp | 4 Terminal | Ringless | 300 VAC



U1232-RRL-KK-K1

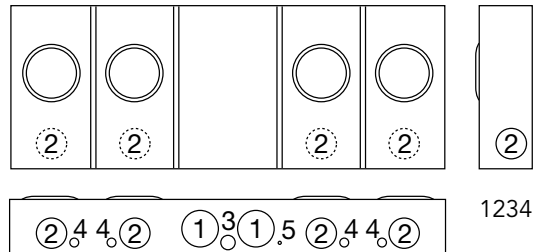
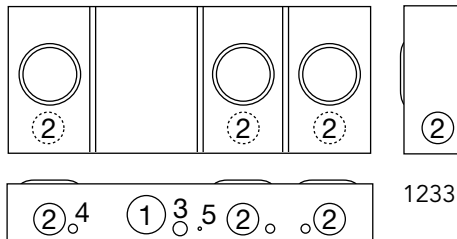
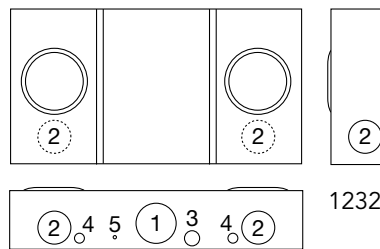

150 Amp per Position | 4 Terminal | Multi-Position | Ringless | Horn Bypass

Catalog Number	Positions	Service	Hub	Connectors CU/AL		Dimensions			Knockouts				
				Line	Load	D"	W"	H"	1	2	3	4	5
U1232-RRL-KK-K1	2	OH/UG	H.O.	#6-350	#6-350	5½	26½	14	3	2½	1	½	¼
U1233-RRL-KK-K1	3	OH/UG	H.O.	#6-350	#6-350	5½	34¾	14	3	2½	1	½	¼
U1234-RXL-KK-K1	4	OH/UG	C.P.	#6-350	#6-350	5½	42⅞	16	3	2½	1	½	¼

## Notes

- **Hubs:** For proper hub selection, refer to the hub suffix chart on the accessories page. For the **U1254-6** two hub openings are supplied and the extra opening is closed with a closing plate as standard.
- **Fifth Terminal:** For field mounted fifth terminal, order catalog number **K5T** (9 o'clock position).



Please consult serving utility for their requirements prior to ordering or installing, as specifications and approvals vary by utility, and may require local electrical inspector approval. All installations must be installed by a licensed electrician and must comply with all national and local codes, laws and regulations. Milbank reserves the right to make changes in specifications and features shown without notice or obligation.

# Multi-Position Sockets

200 Amp | 4 Terminal | Ringless | 300 VAC

**21**  
200 AMP  
MULTI-  
POSITION



U1252-RRL-KK-K1-SLVG

200 Amp per Position | 4 Terminal | Multi-Position | Ringless | Horn Bypass

Catalog Number	Positions	Service	Hub	Connectors CU/AL		Dimensions		
				Line	Load	D"	W"	H"
U1252-RRL-KK-K1-SLVG	2	OH/UG	H.O.	#6-350	#6-350	5 $\frac{1}{8}$	26 $\frac{1}{2}$	14
U1252-RRL-KK-K1-BLG-SLVG	2	OH/UG	H.O.	#6-350	#6-350	5 $\frac{1}{8}$	26 $\frac{1}{2}$	14
U1253-RRL-KK-K1-SLVG	3	OH/UG	H.O.	#6-350	#6-350	5 $\frac{1}{8}$	34 $\frac{3}{4}$	14
U1253-RRL-KK-K1-BLG-SLVG	3	OH/UG	H.O.	#6-350	#6-350	5 $\frac{1}{8}$	34 $\frac{3}{4}$	14
U1254-RXL-KK-K1-SLVG	4	OH/UG	C.P.	#6-350	#6-350	5 $\frac{1}{8}$	42 $\frac{7}{8}$	16
U1254-RXL-KK-K1-BLG-SLVG	4	OH/UG	H.O.	#6-350	#6-350	5 $\frac{1}{8}$	42 $\frac{7}{8}$	16
U1255-RXL-KK-K1-SLVG	5	OH/UG	C.P.	#6-350	#6-350	5 $\frac{1}{8}$	54 $\frac{1}{2}$	16
U1255-RXL-KK-K1-BLG-SLVG	5	OH/UG	H.O.	#6-350	#6-350	5 $\frac{1}{8}$	54 $\frac{1}{2}$	16
U1256-RXL-KK-K1-SLVG	6	OH/UG	C.P.	#6-350	#6-350	5 $\frac{1}{8}$	63 $\frac{1}{16}$	18
U1256-RXL-KK-K1-BLG-SLVG	6	OH/UG	H.O.	#6-350	#6-350	5 $\frac{1}{8}$	63 $\frac{1}{16}$	18

## Notes

- **Hubs:** For proper hub selection, refer to the hub suffix chart on the accessories page. For the **U1254-6** two hub openings are supplied and the extra opening is closed with a closing plate as standard.
- **Fifth Terminal:** For field mounted fifth terminal, order catalog number **K5T** (9 o'clock position).
- **Product numbers with BLG are used in AEP service areas.**

Please consult serving utility for their requirements prior to ordering or installing, as specifications and approvals vary by utility, and may require local electrical inspector approval. All installations must be installed by a licensed electrician and must comply with all national and local codes, laws and regulations. Milbank reserves the right to make changes in specifications and features shown without notice or obligation.



# Multi-Position Sockets

*Knockout information*

Knockouts				
1	2	3	4	5
3	2½	1	½	¼

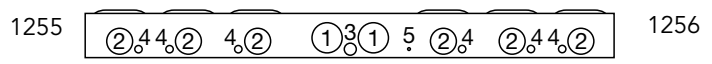
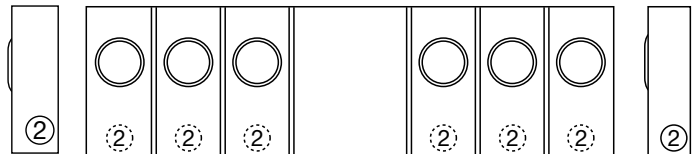
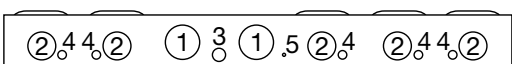
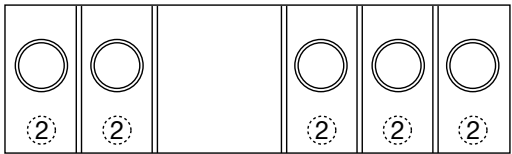
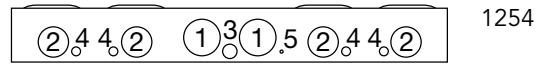
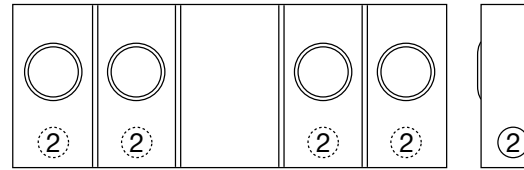
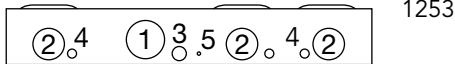
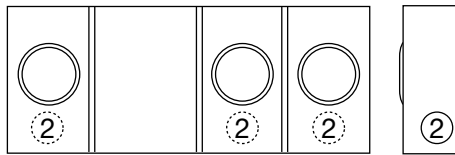
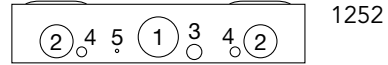
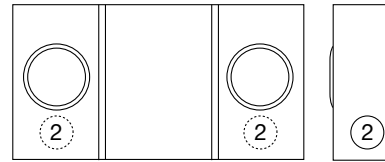

Please consult serving utility for their requirements prior to ordering or installing, as specifications and approvals vary by utility, and may require local electrical inspector approval. All installations must be installed by a licensed electrician and must comply with all national and local codes, laws and regulations. Milbank reserves the right to make changes in specifications and features shown without notice or obligation.

# Lever Bypass Multi-Position Sockets

200 Amp | 5 Terminal | Ringless | 600 VAC

**23**  
200 AMP  
LEVER BYPASS  
MULTI-  
POSITION



U2873-XT

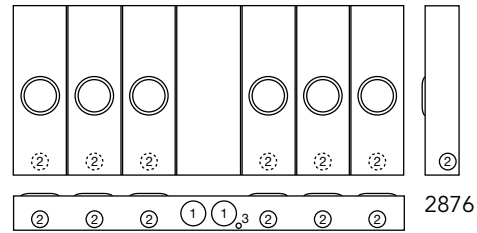
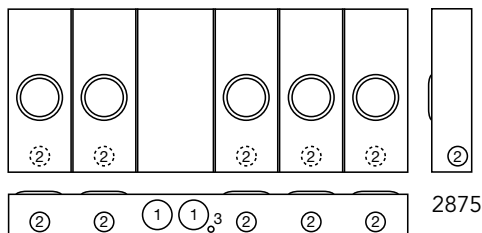
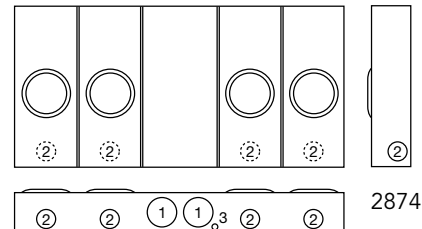
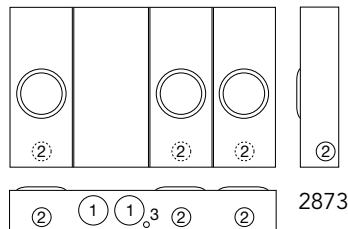
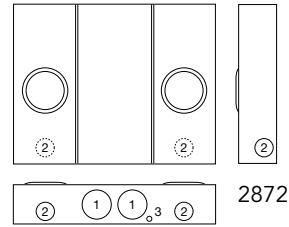

200 Amp per Position | 5 Terminal | Multi-Position | OH/UG | Ringless

Catalog Number	Positions	Hub	Connectors CU/AL		Bypass	Dimensions			Knockouts		
			Line	Load		D"	W"	H"	1	2	3
U2872-XT	2	(2) C.P.	3/8" x 16 Stud	#6-350	Lever	6	32 1/8	25 1/4	4	2 1/2	1 1/4, 1/2
U2873-XT	3	(2) C.P.	3/8" x 16 Stud	#6-350	Lever	6	42 3/16	25 1/4	4	2 1/2	1 1/4, 1/2
U2874-XT	4	(2) C.P.	3/8" x 16 Stud	#6-350	Lever	6	52 1/4	25 1/4	4	2 1/2	1 1/4, 1/2
U2875-XT	5	(2) C.P.	3/8" x 16 Stud	#6-350	Lever	6	62 5/16	25 1/4	4	2 1/2	1 1/4, 1/2
U2876-XT	6	(2) C.P.	3/8" x 16 Stud	#6-350	Lever	6	72 3/8	31 1/4	4	2 1/2	1 1/4, 1/2

## Notes

- **Hubs:** Units supplied with two closing plates. To order hubs as extra, refer to the hub suffix chart on the accessories page.
- **Connector Kits:** For line side connector kits, order as extra **K1539** (350 kcmil), **K1540** (600 kcmil), twin **K1350** (350 kcmil), twin **K1541** (600 kcmil). Line connectors can be reversed to change from "OH" to "UG" service. For line side connector lug kits, order as extra from chart on the accessories page.
- **Bypass:** Lever supplies clamping action on meter spades and also operates bypass device.

Please consult serving utility for their requirements prior to ordering or installing, as specifications and approvals vary by utility, and may require local electrical inspector approval. All installations must be installed by a licensed electrician and must comply with all national and local codes, laws and regulations. Milbank reserves the right to make changes in specifications and features shown without notice or obligation.



# 24

200 AMP  
LEVER BYPASS  
MULTI-  
POSITION

# Lever Bypass Multi-Position Sockets

200 Amp | 7 Terminal | Ringless | 600 VAC 3 phase

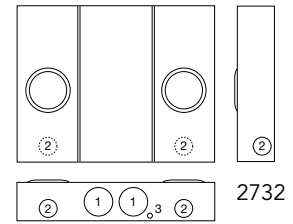

U2732-XT

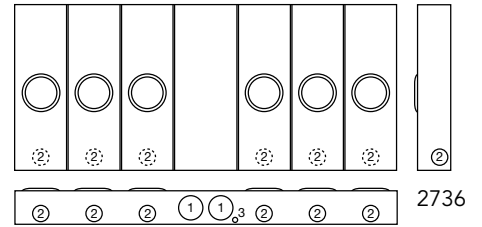
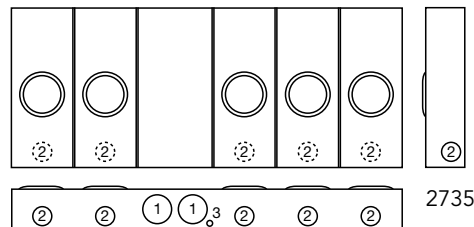
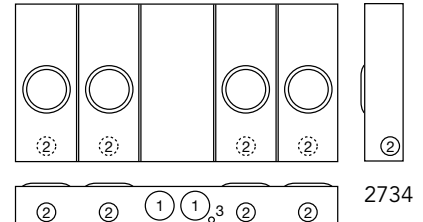
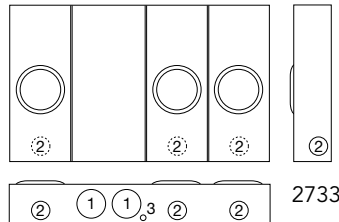

200 Amp per Position | 7 Terminal | Multi-Position | OH/UG | Lever Bypass | Ringless

Catalog Number	Positions	Hub	Connectors CU/AL		Dimensions			Knockouts		
			Line	Load	D"	W"	H"	1	2	3
U2732-XT	2	(2) C.P.	3/8" x 16 Stud	#6-350	6	32 3/8	25 1/4	4	2 1/2	1/4, 1/2
U2733-XT	3	(2) C.P.	3/8" x 16 Stud	#6-350	6	42 3/16	25 1/4	4	2 1/2	1/4, 1/2
U2734-XT	4	(2) C.P.	3/8" x 16 Stud	#6-350	6	52 1/4	25 1/4	4	2 1/2	1/4, 1/2
U2735-XT	5	(2) C.P.	3/8" x 16 Stud	#6-350	6	62 5/16	25 1/4	4	2 1/2	1/4, 1/2
U2736-XT	6	(2) C.P.	3/8" x 16 Stud	#6-350	6	72 3/8	31 1/4	4	2 1/2	1/4, 1/2

## Notes

- **Hubs:** Units supplied with two closing plates. To order hubs as extra, refer to the hub suffix chart on the accessories page.
- **Connector Kits:** For line side connector kits, order as extra **K3082** (350 kcmil), **K3441** (600 kcmil), twin **K3442** (350 kcmil), twin **K3083** (600 kcmil). Line connectors can be reversed to change from "OH" to "UG" service.
- **Bypass:** Lever supplies clamping action on meter spades and also operates bypass device.



Please consult serving utility for their requirements prior to ordering or installing, as specifications and approvals vary by utility, and may require local electrical inspector approval. All installations must be installed by a licensed electrician and must comply with all national and local codes, laws and regulations. Milbank reserves the right to make changes in specifications and features shown without notice or obligation.



# Multi-Position Meter Mains

125 & 200 Amp/Position | 4 Terminal | Ringless | 120/240 VAC

**25**  
125 & 200 AMP  
MULTI-  
POSITION  
METER MAINS



**U2854-X**

(Order circuit breakers separately)



**U2866-X**

## 125 Amp Per Position | Multi-Position Sockets | Ringless

Catalog Number	Amps Per Position	Positions	Main Bus Rating	Line Connector Size	Dimensions		
					D"	W"	H"
U2852-X	125	2	200 Amp	3/8" x 16 Stud*	5 13/16	18	25
U2853-X	125	3	200 Amp	3/8" x 16 Stud*	5 13/16	18	37
U2854-X	125	4	400 Amp	3/8" x 16 Stud*	4 7/8	31	25
U2855-X	125	5	400 Amp	3/8" x 16 Stud*	4 7/8	31	37
U2856-X	125	6	400 Amp	3/8" x 16 Stud*	4 7/8	31	37

## 200 Amp Per Position | Multi-Position Sockets | Ringless

Catalog Number	Amps Per Position	Positions	Main Bus Rating	Line Connector Size	Dimensions		
					D"	W"	H"
U2862-X	200	2	250 Amp	3/8" x 16 Stud*	5 13/16	21	29
U2863-X	200	3	300 Amp	3/8" x 16 Stud*	5 13/16	21	41
U2864-X	200	4	400 Amp	3/8" x 16 Stud*	4 7/8	36	29
U2865-X	200	5	600 Amp	3/8" x 16 Stud*	4 7/8	36	41
U2866-X	200	6	600 Amp	3/8" x 16 Stud*	4 7/8	36	41

### Connector Kits\*

Size	Suffix	Kit Number	Compatible With	Wire Range
Single	-K1	<b>K1539</b>	U2852-56, U2862-66	#6-350
	-K3	<b>K1540</b>	U2854-56, U2864-66	#4-600
Twin	-K2	<b>K1350</b>	U2854-56, U2863-66	#6-350
	-K4	<b>K1541</b>	U2864-66	#2-600

### Breaker Chart

Manufacturer	150-200 Amps	125 Amps or Less
Milbank	WBJ	—
Cutler Hammer	BR, BJ	Quicklag P, BR, HQP
Siemens	QNR	QP
Siemens/Murray	MD	MP
G.E.	Q Line	Q Line
Square D	—	Homeline

### Notes

- **Connectors:** For line wire connector kits, order separately.
- **Fifth Terminal:** For field mounted fifth terminal, order catalog number **K2381**. Order one per meter position.
- **Breakers:** Units have provision for one double pole main per meter position. Breakers not included.
- **Short Circuit Current Rating:** 10K AIC. However, this rating is limited to the lowest interrupting capacity of any circuit breaker installed. Watthour meter not included in short circuit current rating.
- **Knockouts:** See next page for drawings and knockout configurations.

Please consult serving utility for their requirements prior to ordering or installing, as specifications and approvals vary by utility, and may require local electrical inspector approval. All installations must be installed by a licensed electrician and must comply with all national and local codes, laws and regulations. Milbank reserves the right to make changes in specifications and features shown without notice or obligation.



# Multi-Position Meter Mains

## Knockout Information

Catalog Number	Knockouts		
	1	2	3
U2852-X	3	1¼	¼, ½
U2853-X	3	1¼	¼, ½
U2854-X	3	1¼	¼, ½
U2855-X	3	1¼	¼, ½
U2856-X	3	1¼	¼, ½
U2862-X	3	2	¼, ½
U2863-X	3	2	¼, ½
U2864-X	3	2	¼, ½
U2865-X	3	2	¼, ½
U2866-X	3	2	¼, ½

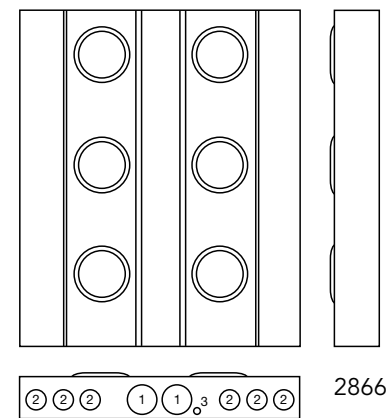
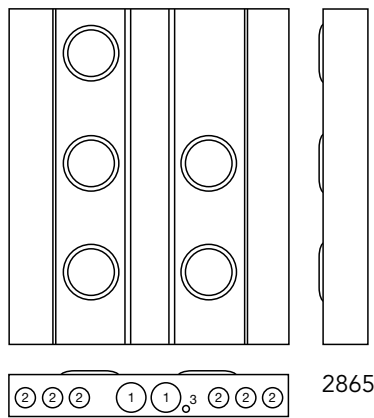
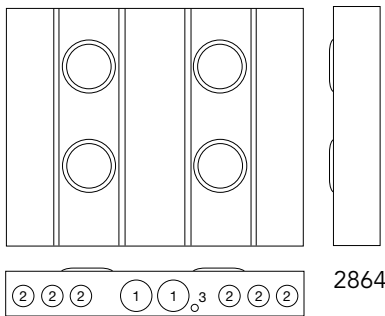
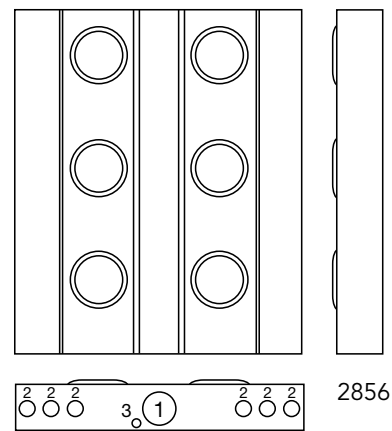
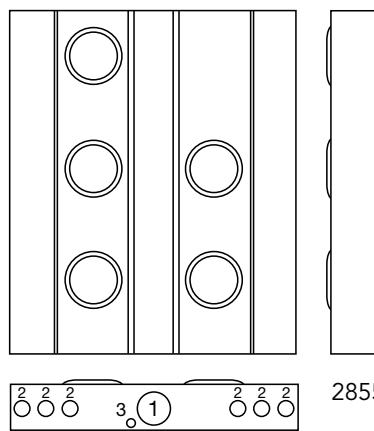
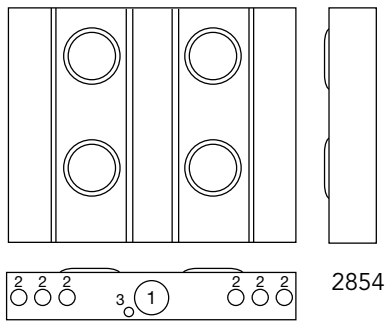
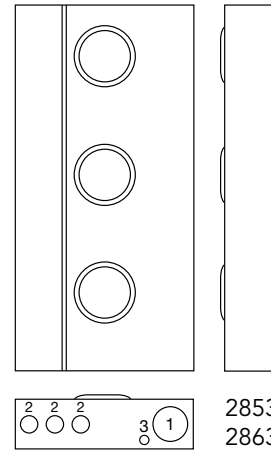
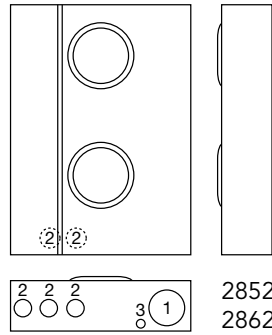

Please consult serving utility for their requirements prior to ordering or installing, as specifications and approvals vary by utility, and may require local electrical inspector approval. All installations must be installed by a licensed electrician and must comply with all national and local codes, laws and regulations. Milbank reserves the right to make changes in specifications and features shown without notice or obligation.

# Multi-Position Meter Mains

125-200 Amp | 4 Terminal | Ringless | 120/240 VAC | 22KAIC

**27**  
125-200 AMP  
MULTI-  
POSITION  
METER MAINS



U5882-X-KK-BLG



U5884-X-KK-BLG

## 125 Amp per Position | 4 Terminal | Multi-Position Meter Main | Ringless

Catalog Number	Amps	Positions	Service	Hub	Connectors CU/AL	Bypass	Dimensions			Weight (lbs.)
					Line		D"	W"	H"	
U5902-X-KK-BLG	125	2	OH/UG	C.P.	3/8" x 16 Stud	Horn	5 1/8"	26 1/2"	30"	58
U5903-X-KK-BLG	125	3	OH/UG	C.P.	3/8" x 16 Stud	Horn	5 1/8"	34 5/8"	30"	88
U5904-X-KK-BLG	125	4	OH/UG	C.P.	3/8" x 16 Stud	Horn	5 1/8"	42 5/8"	30"	107
U5905-X-KK-BLG	125	5	OH/UG	C.P.	3/8" x 16 Stud	Horn	5 1/8"	51 1/20"	30"	128
U5906-X-KK-BLG	125	6	OH/UG	C.P.	3/8" x 16 Stud	Horn	5 1/8"	59 3/10"	30"	146

## 200 Amp per Position | 4 Terminal | Multi Position Meter Main | Ringless

Catalog Number	Amps	Positions	Service	Hub	Connectors CU/AL	Bypass	Dimensions			Weight (lbs.)
					Line		D"	W"	H"	
U5882-X-KK-BLG	200	2	OH/UG	C.P.	3/8" x 16 Stud	Horn	5 1/8"	26 1/2"	30"	58
U5883-X-KK-BLG	200	3	OH/UG	C.P.	3/8" x 16 Stud	Horn	5 1/8"	34 5/8"	30"	88
U5884-X-KK-BLG	200	4	OH/UG	C.P.	3/8" x 16 Stud	Horn	5 1/8"	42 5/8"	30"	107
U5885-X-KK-BLG	200	5	OH/UG	C.P.	3/8" x 16 Stud	Horn	5 1/8"	51 1/20"	30"	128
U5886-X-KK-BLG	200	6	OH/UG	C.P.	3/8" x 16 Stud	Horn	5 1/8"	59 3/10"	30"	146

## Notes

- **Knockouts:** See drawings on the next page.
- **Optional:** Factory installed breakers are available - consult factory.
- **AIC Rating:** All models are rated 22K AIC when used with approved breakers rated at 22K.
- **Hub:** Units supplied with one (1) closing plate. Order hubs separately, see accessory page.
- **Fifth Terminal:** For field installed fifth terminal, order K5T.
- **Connectors:** Socket is supplied with 3/8" - 16 hex head nuts with Belleville washers. For connector lug kits, order as extra from chart on the accessories page. Separate lug kits are required for line and load.

Please consult serving utility for their requirements prior to ordering or installing, as specifications and approvals vary by utility, and may require local electrical inspector approval. All installations must be installed by a licensed electrician and must comply with all national and local codes, laws and regulations. Milbank reserves the right to make changes in specifications and features shown without notice or obligation.



# 28

125/200 AMP  
MULTI-  
POSITION  
METER MAINS

# Multi-Position Meter Mains

## Dimensional Information

Knockouts				
1	2	3	4	5
3	2½	1	¾	¼

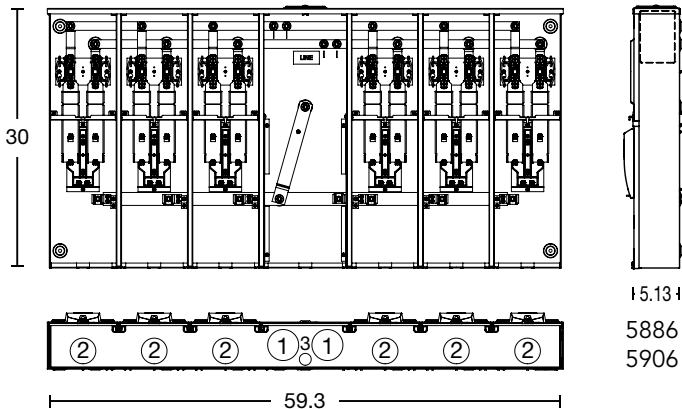
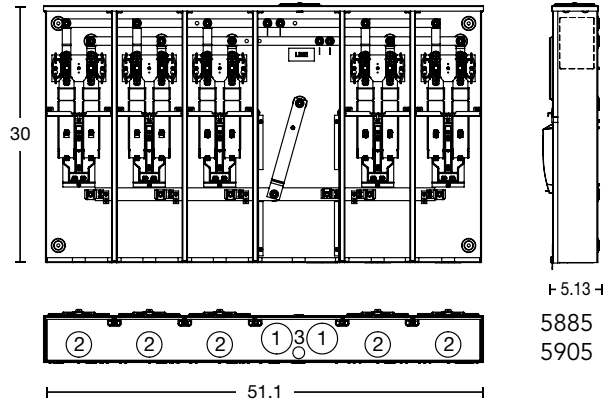
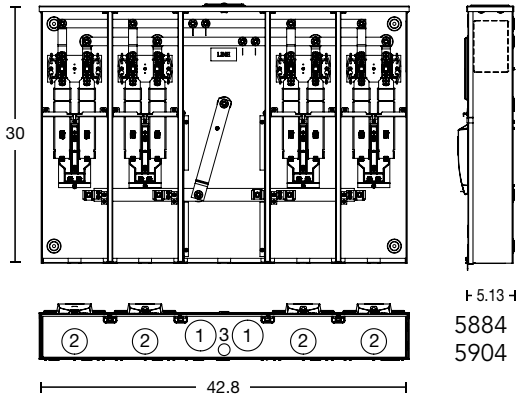
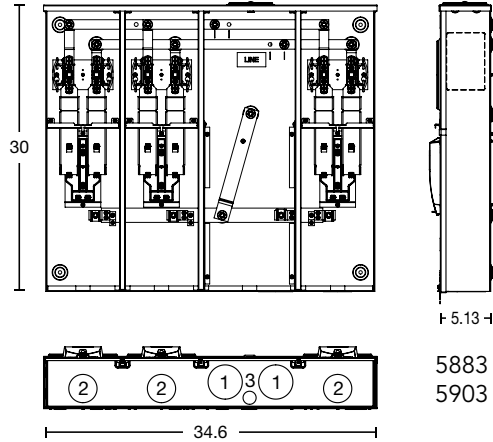
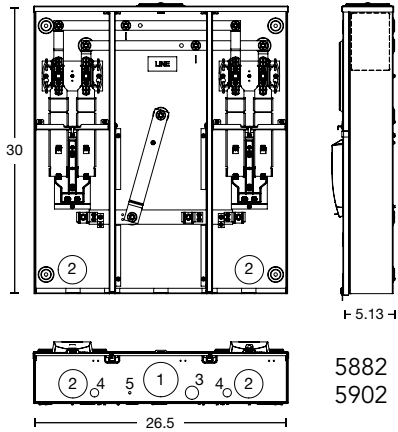

Please consult serving utility for their requirements prior to ordering or installing, as specifications and approvals vary by utility, and may require local electrical inspector approval. All installations must be installed by a licensed electrician and must comply with all national and local codes, laws and regulations. Milbank reserves the right to make changes in specifications and features shown without notice or obligation.

# Transformer Rated

20 Amp | Plunger Bypass | Ringless & Ring Type

**29**  
20 AMP  
TRANSFORMER  
RATED



UC7235

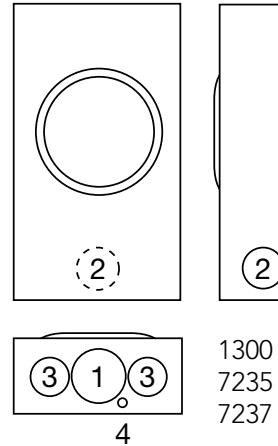

## 1 Piece Cover | Overhead/Underground | Ringless

Catalog Number	Terminals	Type	Hub	Meter Form	Connectors CU	Dimensions			Knockouts			
						D"	W"	H"	1	2	3	4
UC1299-RL	6	Ringless	H.O.	4S	#14-#4 MAX	3 <sup>5</sup> / <sub>16</sub>	8	14	2	1 <sup>1</sup> / <sub>2</sub>	1 <sup>1</sup> / <sub>4</sub>	1 <sup>1</sup> / <sub>4</sub>
UC7235-RL	8	Ringless	H.O.	5S	#14-#4 MAX	3 <sup>5</sup> / <sub>16</sub>	8	14	2	1 <sup>1</sup> / <sub>2</sub>	1 <sup>1</sup> / <sub>4</sub>	1 <sup>1</sup> / <sub>4</sub>
UC7237-XL	13	Ringless	C.P.	6, 8, 9	#14-#4 MAX	3 <sup>5</sup> / <sub>16</sub>	8	14	2	1 <sup>1</sup> / <sub>2</sub>	1 <sup>1</sup> / <sub>4</sub>	1 <sup>1</sup> / <sub>4</sub>

## 1 Piece Cover | Overhead/Underground | Ring Type

Catalog Number	Terminals	Type	Hub	Meter Form	Connectors CU	Dimensions			Knockouts			
						D"	W"	H"	1	2	3	4
UC1300-RL	6	Ring Type	H.O.	4S	#14-#4 MAX	3 <sup>5</sup> / <sub>16</sub>	8	14	2	1 <sup>1</sup> / <sub>2</sub>	1 <sup>1</sup> / <sub>4</sub>	1 <sup>1</sup> / <sub>4</sub>

## Notes

- **Hubs:** For proper hub selection see the hub suffix chart on the accessory page.

Please consult serving utility for their requirements prior to ordering or installing, as specifications and approvals vary by utility, and may require local electrical inspector approval. All installations must be installed by a licensed electrician and must comply with all national and local codes, laws and regulations. Milbank reserves the right to make changes in specifications and features shown without notice or obligation.



# Transformer Rated

## 20 Amp | Test Switch Provision

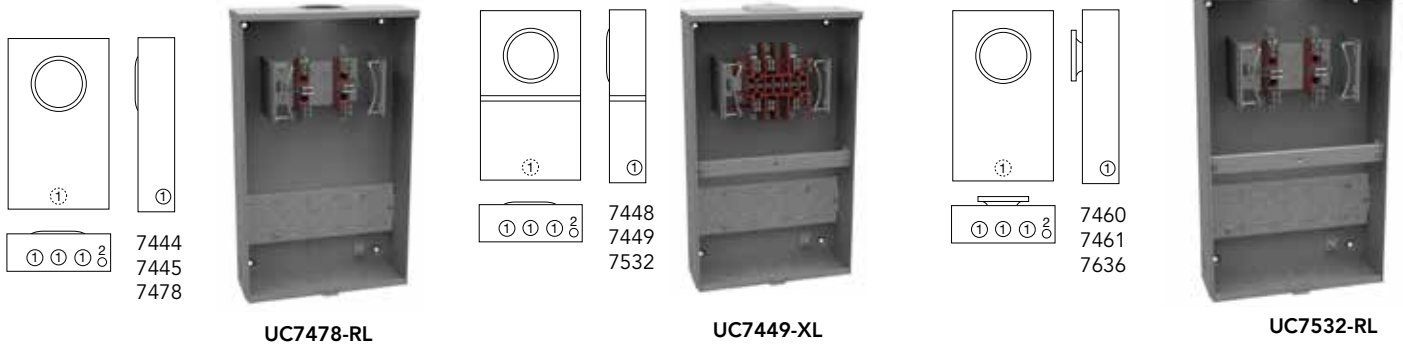

### 1 Piece Cover | Ringless | Overhead/Underground | with test switch provision

Catalog Number	Terminals	Hub	Meter Form	Connectors CU	Bypass	Dimensions			Knockouts	
						D"	W"	H"	1	2
UC7478-RL	6	H.O.	4S	#14 - #4 Max	None	4 $\frac{1}{8}$	12	20	1 $\frac{1}{4}$	$\frac{1}{4}$ , $\frac{1}{2}$
UC7444-RL	8	H.O.	5S	#14 - #4 Max	None	4 $\frac{1}{8}$	12	20	1 $\frac{1}{4}$	$\frac{1}{4}$ , $\frac{1}{2}$
UC7445-RL	13	H.O.	6, 8, 9	#14 - #4 Max	None	4 $\frac{1}{8}$	12	20	1 $\frac{1}{4}$	$\frac{1}{4}$ , $\frac{1}{2}$
UC7445-RL-641*	13	H.O.	6, 8, 9	#14 - #4 Max	None	4 $\frac{1}{8}$	12	20	1 $\frac{1}{4}$	$\frac{1}{4}$ , $\frac{1}{2}$
UC7445-WL	13	1 in	6, 8, 9	#14 - #4 Max	None	4 $\frac{1}{8}$	12	20	1 $\frac{1}{4}$	$\frac{1}{4}$ , $\frac{1}{2}$

\*Prewired per Lebanon specifications

### 2 Piece Cover | Overhead/Underground | No Lever Bypass | with test switch provision

Ringless Catalog Number	Ring Type Catalog Number	Terminals	Meter Form	Hub	Connectors CU	Dimensions			Knockouts	
						D"	W"	H"	1	2
UC7532-RL	UC7636-RL	6	4S	H.O.	#14 - #4 Max	4 $\frac{1}{8}$	12	20	1 $\frac{1}{4}$	$\frac{1}{4}$ , $\frac{1}{2}$
UC7448-RL	UC7460-RL	8	5S	H.O.	#14 - #4 Max	4 $\frac{1}{8}$	12	20	1 $\frac{1}{4}$	$\frac{1}{4}$ , $\frac{1}{2}$
UC7449-RL	UC7461-RL	13	6, 8, 9	H.O.	#14 - #4 Max	4 $\frac{1}{8}$	12	20	1 $\frac{1}{4}$	$\frac{1}{4}$ , $\frac{1}{2}$

### Notes

- **Hubs:** For proper hub selection see the hub suffix chart on the accessory page.
- **Sealing Rings:** Ring type units are supplied with one MR-2, snap type, sealing ring.
- **Prewiring:** Factory prewiring available.
- **Connectors:** Units are supplied with mechanical type connectors (#4 max). If compression type connectors (#10) are preferred, change catalog prefix to "S" (i.e., UC7445-XL becomes S7445-XL). The "S" prefix also designates not UL listed.



Please consult serving utility for their requirements prior to ordering or installing, as specifications and approvals vary by utility, and may require local electrical inspector approval. All installations must be installed by a licensed electrician and must comply with all national and local codes, laws and regulations. Milbank reserves the right to make changes in specifications and features shown without notice or obligation.

# Lever Bypass Transformer Rated

80 Amp | 6, 8 & 13 Terminal

**31**  
80 AMP  
TRANSFORMER  
RATED



U4490-XL

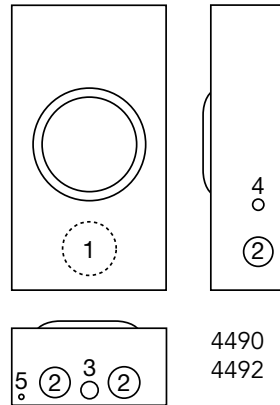

## 80 Amp | Ringless | Transformer Rated | Lever Bypass

Catalog Number	Terminals	Service	Hub	Meter Form	Connectors CU	Dimensions			Knockouts				
						D"	W"	H"	1	2	3	4	5
U4490-XL	6	OH/UG	C.P.	4S	#14 - #4 Max	4 <sup>7</sup> / <sub>8</sub>	10	18 <sup>1</sup> / <sub>2</sub>	3	1 <sup>1</sup> / <sub>2</sub>	1 <sup>1</sup> / <sub>2</sub> , <sup>3</sup> / <sub>4</sub>	<sup>3</sup> / <sub>4</sub>	<sup>1</sup> / <sub>4</sub>
U4492-XL	8	OH/UG	C.P.	5S	#14 - #4 Max	4 <sup>7</sup> / <sub>8</sub>	10	18 <sup>1</sup> / <sub>2</sub>	3	1 <sup>1</sup> / <sub>2</sub>	1 <sup>1</sup> / <sub>2</sub> , <sup>3</sup> / <sub>4</sub>	<sup>3</sup> / <sub>4</sub>	<sup>1</sup> / <sub>4</sub>
U4493-XL	13	OH/UG	C.P.	6, 8, 9	#14 - #4 Max	4 <sup>7</sup> / <sub>8</sub>	10	18 <sup>1</sup> / <sub>2</sub>	3	1 <sup>1</sup> / <sub>2</sub>	1 <sup>1</sup> / <sub>2</sub> , <sup>3</sup> / <sub>4</sub>	<sup>3</sup> / <sub>4</sub>	<sup>1</sup> / <sub>4</sub>

## Notes

- **Hubs:** For proper hub selection see the hub suffix chart on the accessory page.
- **Bypass:** Lever operates current bypass device and also supplies clamping action on current meter spades.
- **Connectors:** Units are supplied with mechanical type connectors (#4 max).

Please consult serving utility for their requirements prior to ordering or installing, as specifications and approvals vary by utility, and may require local electrical inspector approval. All installations must be installed by a licensed electrician and must comply with all national and local codes, laws and regulations. Milbank reserves the right to make changes in specifications and features shown without notice or obligation.



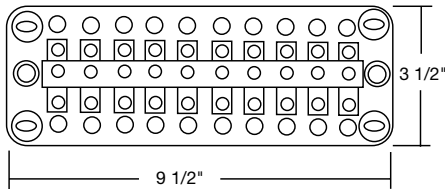
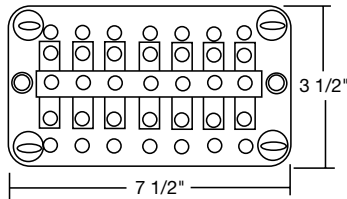
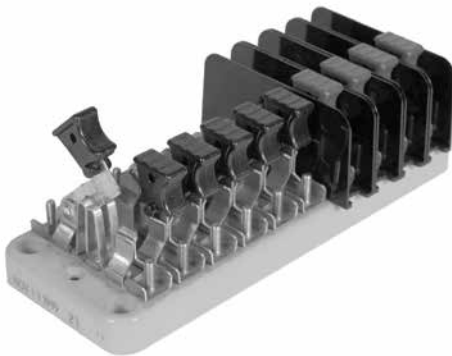

Key	
P	Potential Switch
C+	Line side current switch with short circuit assembly
C	Load side current switch with test jack assembly
N	Neutral bar (no switch)
Pn	Neutral Potential Switch
X	Unused Position on base
	Insulating barrier, isolates both sides of switch

Catalog Number	4-Pole						
TS04-0101	X	P		X	C+	C	X
TS04-0102	X		C+	C	X	Pn	X
TS04-0103	X	P		X	C	C+	X
TS04-0104	X	C+	C	X	P		X

### Notes

- 4-pole switches are also available on 10-pole bases. Contact Milbank for appropriate catalog numbers.

Catalog Number	7-Pole						
TS07-0105		P		C+	C	C+	C
TS07-0106		C+	C		C+	C	
TS07-0107		P		C	C+	C	C+
TS07-0108	C+	C	C+	C		P	

### Notes

- 4-pole switches are also available on 10-pole bases. Contact Milbank for appropriate catalog numbers.

Catalog Number	7-Pole on a 10-Pole Base									
TS07-0049		X		X		X	C+	C	C	C+
TS07-0018		X		X		X	C+	C	C+	C
TS07-0059	X		C+	C		C	C+		X	X
TS07-0022	P	X	P	X	Pn	X	C	C+	C	C+

Catalog Number	10-Pole									
TS10-0109	P		P		C+	C	C+	C	C+	C
TS10-0110		C+	C		C+	C		C+	C	
TS10-0111	P		P		C	C+	C	C+	C	C+
TS10-0112	C+	C	C+	C	C+	C		P		



Please consult serving utility for their requirements prior to ordering or installing, as specifications and approvals vary by utility, and may require local electrical inspector approval. All installations must be installed by a licensed electrician and must comply with all national and local codes, laws and regulations. Milbank reserves the right to make changes in specifications and features shown without notice or obligation.



# Test Switch Worksheet

Electronic version available at [milbankworks.com](http://milbankworks.com)



Customer Name: \_\_\_\_\_

Email: \_\_\_\_\_

Phone: \_\_\_\_\_

Handle Color Key							
BK	Black	P	Purple	Y	Yellow	GN	Green
R	Red	BL	Blue	W	White	BKS	Black Stripe
BR	Brown	GR	Grey	O	Orange	WS	White Stripe

### TEST SWITCH BASE

The base is molded from a high strength, fiberglass reinforced, thermoset polyester. This material is track-resistant, flame-retardant and has low water absorption qualities. Bases are available in two standard sizes following NEMA mounting classifications.

### Pole Position Chart

1	2	3	4	5	6	7	8	9	10

### Special Features

Feature	1	2	3	4	5	6	7	8	9	10
45° Angle Stops										
Ganged Handles (C)										
Bussing										
Colored Handles										

Engineering Information: \_\_\_\_\_

Key	
P	Potential Switch
C+	Line side current switch with short circuit assembly
C	Load side current switch with test jack assembly
N	Neutral bar (no switch)
Pn	Neutral Potential Switch
X	Unused Position on base
	Insulating barrier (one side)
	Insulating barrier (two sides)

**Custom Pole Arrangements:** The key may be used to diagram your own pole arrangement. Be sure to specify base size and whether all C+ line side, current switch/shunt circuit assemblies are to be bussed together. The catalog numbers shown above are connected in line-load pairs; therefore, if bussed is required, different catalog numbers will apply.

### Number of Poles

- 4
- 7
- 10
- Other \_\_\_\_\_

### Test Switch Cover (only available for 10-pole bases)

- Yes | Clear \_\_\_\_ Black \_\_\_\_
- No

### Base Size

- 7-Pole
- 10-Pole

Please consult serving utility for their requirements prior to ordering or installing, as specifications and approvals vary by utility, and may require local electrical inspector approval. All installations must be installed by a licensed electrician and must comply with all national and local codes, laws and regulations. Milbank reserves the right to make changes in specifications and features shown without notice or obligation.





304410-CTC3R

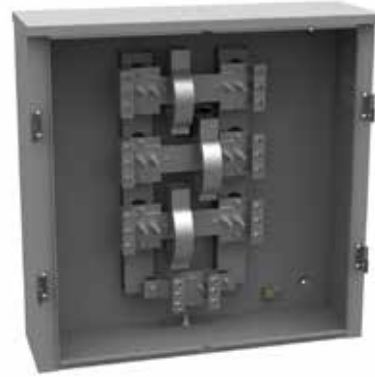

U5990-O

## Outdoor Transformer Cabinets | NEMA 3R

Catalog Number	Dimensions			Gauge of Steel	Board Size		CT Mounting Provisions	# of Doors	Latching Type
	D"	W"	H"		W"	H"			
U4408-O	14	40	40	12	40	40	Wood	2	3 point latch
U4410-O	12	32	24		28	20	Wood	1	Flip latch
S4019-O	10	32	24	14	24	16	Wood	2	3 point latch
S4020-O	10	36	32	14	28	24	Wood	2	3 point latch
S4399-O	10	24	18	14	16	10	Wood	2	3 point latch
S4400-O	10	44	30	14	36	22	Wood	2	3 point latch
304410-CTC3R	10	44	30	12	—	—	None	2	Hasp
243210-CTC3R	10	32	24	14	—	—	None	2	Hasp
363612-LC3R-SP-WB	12	36	36	14	33	33	Rails	1	Wing handle
484812-CT3R-WB	12	48	48	14	44	44	Rails	2	3 point latch
U5990-O	10	36	36	12	CT mounting rack included			2	Flip latch

## Notes

- **Features:** Supplied with solid back board when noted, three point locking handle, lift off hinges with stainless steel pins and padlock provisions.
- **U5990-O:** is 3Ø with a 50K RMS rating, and has a wire range of #4-600 kcmil.
- Non UL listed.
- See utility approval chart on pages 62.



Please consult serving utility for their requirements prior to ordering or installing, as specifications and approvals vary by utility, and may require local electrical inspector approval. All installations must be installed by a licensed electrician and must comply with all national and local codes, laws and regulations. Milbank reserves the right to make changes in specifications and features shown without notice or obligation.

# Meter Main with Load Center Pedestal

200 Amp | 4 Terminal | Ringless | 120/240 VAC

**35**  
200 AMP  
METER MAIN WITH  
LOAD  
CENTER  
PEDESTAL



**U5136-O-200S**  
(shown with 20 amp receptacle and breaker with -10GR suffix)

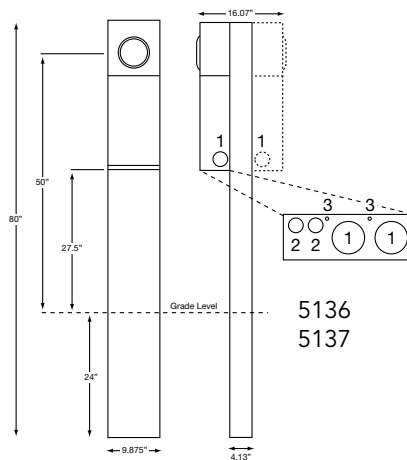

**U6220-O-20**

## 200 Amps | 4 Terminal | Meter Main Pedestal | Ringless

Catalog Number	Breaker Amps	Service	Powerheads	Branch Circuits	Bypass	Connectors CU/AL		Knockouts		
						Line	Load	1	2	3
U5136-O	Provision	UG	Single	4	Horn	#6-350	CB	2	1/2, 3/4	1/4
U5136-O-100S	100	UG	Single	4	Horn	#6-350	CB	2	1/2, 3/4	1/4
U5136-O-200S	200	UG	Single	4	Horn	#6-350	CB	2	1/2, 3/4	1/4
U5137-O-200S	200	UG	Double	4	Horn	#6-350	CB	2	1/2, 3/4	1/4

## 100-200 Amps | 4 Terminal | Meter Main Pedestal | Ringless

Catalog Number	Breaker Amps	Service	Powerheads	Branch Circuits	Bypass	Connectors CU/AL		Knockouts		
						Line	Load	1	2	3
U6220-O-100-KK-10GR	100	UG	Single	10	Horn	#6-350	FTL*	2	1/2, 3/4	1/4
U6220-O-200-KK-10GR	200	UG	Single	8	Horn	#6-350	FTL*	2	1/2, 3/4	1/4

## Notes

- **Parallel to Series Conversion:** For field converting from parallel wired to series wired order **K5194**.
- **Fifth Terminal:** For field installed fifth terminal, order **K5T**.
- **Stabilizer Foot:** For field installed stabilizer foot, order **K5415**.
- **Penta Bolt Locking:** For field installed pedestal fronts penta bolt locking, order **K5039**.
- **Receptacles:** Consult factory for installed receptacle assemblies.
- **Short Circuit Current Rating:** 22K AIC. However, this rating is limited to the lowest interrupting capacity of any circuit breaker installed. Watthour meter not included in short circuit current rating.

\*FTL: Feed Through Lugs

Please consult serving utility for their requirements prior to ordering or installing, as specifications and approvals vary by utility, and may require local electrical inspector approval. All installations must be installed by a licensed electrician and must comply with all national and local codes, laws and regulations. Milbank reserves the right to make changes in specifications and features shown without notice or obligation.



# Temporary Power Units

125 Amp | 4 Terminal | Ringless | 120/240 VAC



U5101-XL-11GR

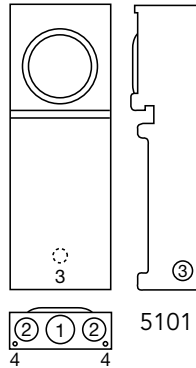

5101



U4908-O-11GR

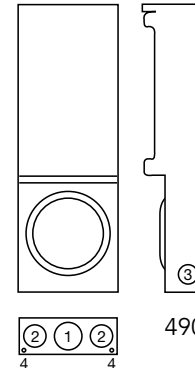

4908

125 Amps | 4 Terminal | Temporary Power Units | Ringless | 1Ø3W

Catalog Number	Service	Hub	Connectors CU/AL		Dimensions			Knockouts					
			Line	Load	D"	W"	H"	1	2	3	4	5	
U5101-XL-11GR	OH	C.P.	#6-350	#6-350	5 <sup>3</sup> / <sub>16</sub>	8 <sup>7</sup> / <sub>8</sub>	25	2	1 <sup>1</sup> / <sub>2</sub>	1 <sup>1</sup> / <sub>4</sub>	1 <sup>1</sup> / <sub>4</sub>	1 <sup>1</sup> / <sub>4</sub>	—
U4908-O-11GR	UG	Blank	#6-2/0	#6-2/0	5 <sup>3</sup> / <sub>16</sub>	9	25 <sup>15</sup> / <sub>16</sub>	2	1 <sup>1</sup> / <sub>2</sub>	1 <sup>1</sup> / <sub>4</sub>	1 <sup>1</sup> / <sub>4</sub>	1 <sup>1</sup> / <sub>4</sub>	—

## Notes

- **Interior:** Six circuit plated copper interior accepts standard plug-in type circuit breakers.
- **Receptacle Bridge:** Three position self-grounded receptacle bridge accepts most standard NEMA receptacles with mounting plates.
- **Included Parts:** U4908 and U5101 come supplied with 2-20 amp single pole breakers and 2-20 amp GFCI receptacles (pre-wired and installed).



Please consult serving utility for their requirements prior to ordering or installing, as specifications and approvals vary by utility, and may require local electrical inspector approval. All installations must be installed by a licensed electrician and must comply with all national and local codes, laws and regulations. Milbank reserves the right to make changes in specifications and features shown without notice or obligation.

# Surface Mount Power Outlet

Millennium Series | Metered & Unmetered | 120/240 VAC

**37**  
SURFACE  
MOUNT POWER  
OUTLET

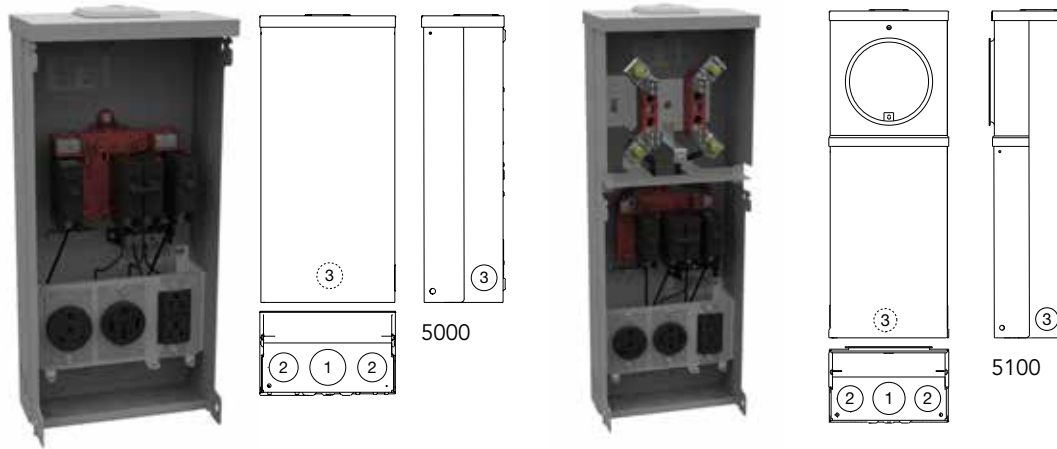

U5000-XL-75

U5100-XL-75

## 125 Amp | Surface Mount Power Outlets

Catalog Number	Metered/Unmetered	Receptacle Configuration	Circuit Breaker Configuration	Loop Feed	Connectors - Line	Dimensions			Knockouts		
						D"	W"	H"	1	2	3
U5000-XL	Unmetered	—	—	Yes	(2) 1/0-#12	5½	9⅞	19¼	2	1½	1¼
U5000-XL-41	Unmetered	A	X	Yes	(2) 1/0-#12	5½	9⅞	19¼	2	1½	1¼
U5000-XL-55	Unmetered	B	Y	Yes	(2) 1/0-#12	5½	9⅞	19¼	2	1½	1¼
U5000-XL-75	Unmetered	C	Z	Yes	(2) 1/0-#12	5½	9⅞	19¼	2	1½	1¼
U5100-XL	Metered	—	—	No	#6-250	5½	9⅞	25	2	1½	1¼
U5100-XL-41	Metered	A	X	No	#6-250	5½	9⅞	25	2	1½	1¼
U5100-XL-55	Metered	B	Y	No	#6-250	5½	9⅞	25	2	1½	1¼
U5100-XL-75	Metered	C	Z	No	#6-250	5½	9⅞	25	2	1½	1¼

### Receptacle Configurations

A	B	C
(1) TT30R, (1) 5-20R GFI	(1) 14-50R, (1) 5-20R GFI	(1) 14-50R, (1) TT30R, (1) 5-20R GFI

**NOTE**  
Contact factory for additional configurations not shown here.

### Circuit Breaker Configurations

X	Y	Z
(1) 30A, 1P, 120V (1) 20A, 1P, 120V	(1) 50A, 2P, 120/240V (1) 20A, 1P, 120V	(1) 50A, 2P, 120/240V (1) 30A, 1P, 120V (1) 20A, 1P, 120V

Please consult serving utility for their requirements prior to ordering or installing, as specifications and approvals vary by utility, and may require local electrical inspector approval. All installations must be installed by a licensed electrician and must comply with all national and local codes, laws and regulations. Milbank reserves the right to make changes in specifications and features shown without notice or obligation.





U5200-XL-75

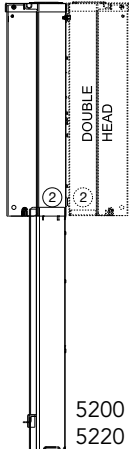
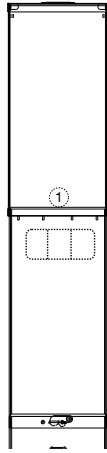

5200  
5220



U5300-O-75

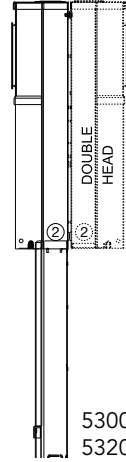
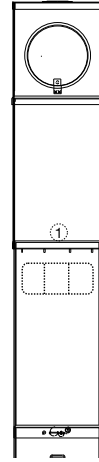

5300  
5320

### 125 Amp | Power Outlet Pedestals | Direct Burial

Catalog Number	Double Head Catalog Number	Metered/ Unmetered	Receptacle Configuration	Circuit Breaker Configuration	Dimensions			Knockout
					D"	W"	H"	1
U5200-XL	U5220-XL	Unmetered	—	—	5 <sup>5</sup> / <sub>16</sub>	9 <sup>1</sup> / <sub>8</sub>	64 <sup>1</sup> / <sub>2</sub>	1 <sup>1</sup> / <sub>4</sub>
U5200-XL-41	U5220-XL-41	Unmetered	A	X	5 <sup>5</sup> / <sub>16</sub>	9 <sup>1</sup> / <sub>8</sub>	64 <sup>1</sup> / <sub>2</sub>	1 <sup>1</sup> / <sub>4</sub>
U5200-XL-55	U5220-XL-55	Unmetered	B	Y	5 <sup>5</sup> / <sub>16</sub>	9 <sup>1</sup> / <sub>8</sub>	64 <sup>1</sup> / <sub>2</sub>	1 <sup>1</sup> / <sub>4</sub>
U5200-XL-75	U5220-XL-75	Unmetered	C	Z	5 <sup>5</sup> / <sub>16</sub>	9 <sup>1</sup> / <sub>8</sub>	64 <sup>1</sup> / <sub>2</sub>	1 <sup>1</sup> / <sub>4</sub>
U5300-O	U5320-O	Metered	—	—	5 <sup>5</sup> / <sub>16</sub>	9 <sup>1</sup> / <sub>8</sub>	70 <sup>1</sup> / <sub>4</sub>	1 <sup>1</sup> / <sub>4</sub>
U5300-O-41	U5320-O-41	Metered	A	X	5 <sup>5</sup> / <sub>16</sub>	9 <sup>1</sup> / <sub>8</sub>	70 <sup>1</sup> / <sub>4</sub>	1 <sup>1</sup> / <sub>4</sub>
U5300-O-55	U5320-O-55	Metered	B	Y	5 <sup>5</sup> / <sub>16</sub>	9 <sup>1</sup> / <sub>8</sub>	70 <sup>1</sup> / <sub>4</sub>	1 <sup>1</sup> / <sub>4</sub>
U5300-O-75	U5320-O-75	Metered	C	Z	5 <sup>5</sup> / <sub>16</sub>	9 <sup>1</sup> / <sub>8</sub>	70 <sup>1</sup> / <sub>4</sub>	1 <sup>1</sup> / <sub>4</sub>

\*Circuit Breaker Bridge included

#### Receptacle Configurations

A	B	C
(1) TT30R, (1) 5-20R GFI	(1) 14-50R, (1) 5-20R GFI	(1) 14-50R, (1) TT30R, (1) 5-20R GFI

#### Circuit Breaker Configurations

X	Y	Z
(1) 30A, 1P, 120V (1) 20A, 1P, 120V	(1) 50A, 2P, 120/240V (1) 20A, 1P, 120V	(1) 50A, 2P, 120/240V (1) 30A, 1P, 120V (1) 20A, 1P, 120V

**NOTE**  
Contact factory for additional configurations not shown here.  
Pad mount is available - contact factory for information.

\*\*Additional Configurations



Please consult serving utility for their requirements prior to ordering or installing, as specifications and approvals vary by utility, and may require local electrical inspector approval. All installations must be installed by a licensed electrician and must comply with all national and local codes, laws and regulations. Milbank reserves the right to make changes in specifications and features shown without notice or obligation.

# Lever Bypass Multi-Position Sockets

200 Amp | 5 Terminal | Ringless

39

LEVER BYPASS  
MULTI-POSITION  
SOCKETS



U4374-XT-5T9

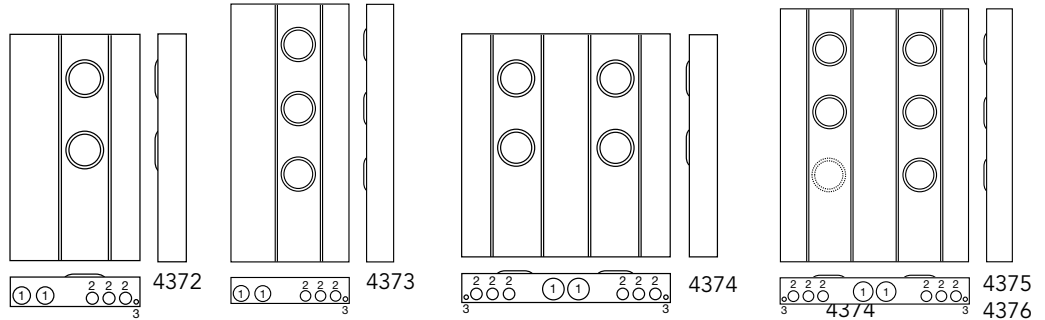

## 200 Amp | 5 Terminal | Lever Bypass | Ringless

Catalog Number	Positions	Main Bus Rating	Line Connector Size	Dimensions			Knockouts		
				D"	W"	H"	1	2	3
U4372-XT-5T9	2	320 Amp	3/8" x 16 Stud*	6	27 3/4	48	3	2	1/4, 1/2
U4373-XT-5T9	3	480 Amp	3/8" x 16 Stud*	6	27 3/4	60	3	2	1/4, 1/2
U4374-XT-5T9	4	640 Amp	3/8" x 16 Stud*	6	45	48	3	2	1/4, 1/2
U4375-XT-5T9	5	640 Amp	3/8" x 16 Stud*	6	45	60	3	2	1/4, 1/2
U4376-XT-5T9	6	640 Amp	3/8" x 16 Stud*	6	45	60	3	2	1/4, 1/2

### Notes

- **\*Connectors:** For line wire connector kits, order separately (see chart above).
- **Breakers:** Units have provision for one double pole main per meter position. Breakers not included. Order as extra (see chart above).
- **Bypass:** Lever supplies clamping action on meter spades and also operates bypass device.
- **Short Circuit Current Rating:** 10K AIC. However, this rating is limited to the lowest interrupting capacity of any circuit breaker installed. Watthour meter not included in short circuit current rating.

### Connector Kits\*

Size	Suffix	Kit Number	Compatible With	Wire Range
Single	-K1	<b>K1539</b>	U2852-56, U2862-66	#6-350
	-K3	<b>K1540</b>	U2854-56, U2864-66	#4-600
Twin	-K2	<b>K1350</b>	U2854-56, U2863-66	#6-350
	-K4	<b>K1541</b>	U2864-66	#2-600

### Breaker Chart

Manufacturer	150-200 Amps	125 Amps or Less
Milbank	WBJ	—
Cutler Hammer	BR, BJ	Quicklag P, BR, HQP
Siemens	QNR	QP
Siemens/Murray	MD	MP
G.E.	Q Line	Q Line
Square D	—	Homeline

Please consult serving utility for their requirements prior to ordering or installing, as specifications and approvals vary by utility, and may require local electrical inspector approval. All installations must be installed by a licensed electrician and must comply with all national and local codes, laws and regulations. Milbank reserves the right to make changes in specifications and features shown without notice or obligation.





**UQFP  
UQFPH**



**UQFP-M  
UQFPH-M**



**UQFB-X1**



**UQFBH**

**200 Amp Frame | Plug-In | 10,000 AIC & 22,000 AIC | Two-Pole - Common Trip**

Amps	10K AIC Plug-In	22K AIC Plug-In	10K AIC Plug-In	22K AIC Plug-In	Wire Range	
					CU	AL
100	UQFP-100	UQFPH-100	UQFP-M-100	UQFPH-M-100	#3-#1	#1-1/0
125	UQFP-125	UQFPH-125	UQFP-M-125	UQFPH-M-125	#3-#1	#1-1/0
150	UQFP-150	UQFPH-150	UQFP-M-150	UQFPH-M-150	1/0-300	2/0-300
175	UQFP-175	UQFPH-175	UQFP-M-175	UQFPH-M-175	1/0-300	2/0-300
200	UQFP-200	UQFPH-200	UQFP-M-200	UQFPH-M-200	1/0-300	2/0-300

**200 Amp Frame | Bolt-On | 10,000 AIC & 22,000 AIC | Two-Pole - Common Trip**

Amps	10K AIC Bolt-On	22K AIC Bolt-On	10K AIC Bolt-On	22K AIC Bolt-On	Wire Range	
					CU	AL
100	UQFB-100	UQFBH-100	UQFB-100-X1	UQFBH-M-100	#3-#1	#1-1/0
125	UQFB-125	UQFBH-125	UQFB-125-X1	UQFBH-M-125	#3-#1	#1-1/0
150	UQFB-150	UQFBH-150	UQFB-150-X1	UQFBH-M-150	1/0-300	2/0-300
175	UQFB-175	UQFBH-175	UQFB-175-X1	UQFBH-M-175	1/0-300	2/0-300
200	UQFB-200	UQFBH-200	UQFB-200-X1	UQFBH-M-200	1/0-300	2/0-300

### Notes

- **UL Listed:** For use with 60°C or 75°C wire.
- **UQFP:** For parallel main circuit breaker applications.
- **UQFP-M:** For series main circuit breaker applications. Split load tab features allow for feed-through capability.
- **UQFB:** (2) 1/0-300 lugs provided on load and line side (cable-in, cable-out).
- **UQFB3:** Three-pole available. Consult factory.
- **UQFB-X:** (2) 1/0-300 lugs provided on load side and (2) line bar bus connections on line side.
- **UQFB-M:** For series main circuit breaker applications. Split load tab features allow for feed-through capability.



Please consult serving utility for their requirements prior to ordering or installing, as specifications and approvals vary by utility, and may require local electrical inspector approval. All installations must be installed by a licensed electrician and must comply with all national and local codes, laws and regulations. Milbank reserves the right to make changes in specifications and features shown without notice or obligation.



# Circuit Breakers

QP (small frame) and QN (large frame) | 120/240 VAC

15–125 Amp Breaker  
Plug-In Type | 1" Per Pole

Amps	Poles	10K AIC Plug-In	22K AIC Plug-In
15	Single	Q115	Q115H
15	Double	Q215	Q215H
20	Single	Q120	Q120H
20	Double	Q220	Q220H
25	Single	Q125	Q125H
25	Double	Q225	Q225H
30	Single	Q130	Q130H
30	Double	Q230	Q230H
35	Single	Q135	Q135H
35	Double	Q235	Q235H
40	Single	Q140	Q140H
40	Double	Q240	Q240H
50	Single	Q150	Q150H
50	Double	Q250	Q250H
60	Single	Q160	Q160H
60	Double	Q260	Q260H
70	Single	Q170	Q170H
70	Double	Q270	Q270H
80	Double	Q280	Q280H
90	Double	Q290	Q290H
100	Double	Q2100	Q2100H
125	Double	Q2125	Q2125H



QN2200H



QN2200RH



WBJ2200



Q250

200 Amp Frame | Plug-In | 10,000 AIC & 22,000 AIC | Two-Pole, Common Trip

Amps	10K AIC Plug-In	22K AIC Plug-In	Handle Location	Wire Range	
				CU	AL
150	QN2150	QN2150H	Left facing	#4-300	#4-300
200	QN2200	QN2200H	Left facing	#4-300	#4-300
150	QN2150R	QN2150RH	Right facing	#4-300	#4-300
200	QN2200R	QN2200RH	Right facing	#4-300	#4-300
150	WBJ2150	—	Centered	#2-300	#2-300
200	WBJ2200	—	Centered	#2-300	#2-300

## Notes

- Load connectors supplied with breakers.
- UL listed for use with 60°C or 75°C wire.
- Wire sizes shown are lug capacity. Consult NEC Article #310 for specific wire sizes.

Please consult serving utility for their requirements prior to ordering or installing, as specifications and approvals vary by utility, and may require local electrical inspector approval. All installations must be installed by a licensed electrician and must comply with all national and local codes, laws and regulations. Milbank reserves the right to make changes in specifications and features shown without notice or obligation.



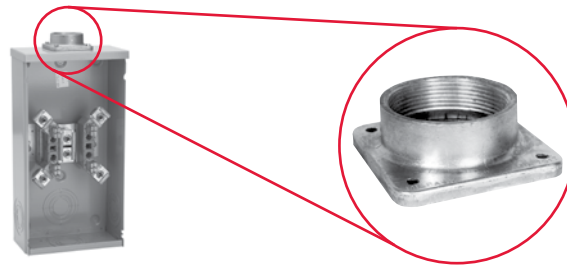
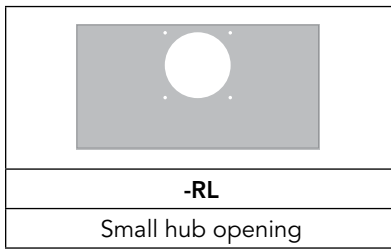

<b>-WL</b>   <b>A7514</b>	<b>-YL</b>   <b>A7515</b>	<b>-ZL</b>   <b>A7516</b>	<b>-DL</b>   <b>A7517</b>	<b>-EL</b>   <b>A7518</b>	<b>-XL</b>   <b>A7551</b>
1" hub	1¼" hub	1½" hub	2" hub	2½" hub	Small closing plate

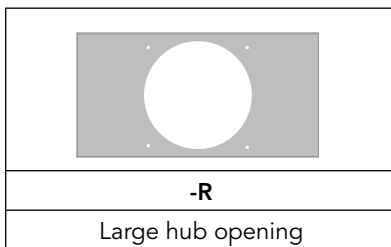

<b>-F</b>   <b>A8110</b>	<b>-G</b>   <b>A8111</b>	<b>-H</b>   <b>A8112</b>	<b>-X</b>   <b>A9064</b>	<b>-RRL</b>   <b>S8324</b>	<b>-RXL</b>   <b>S8324</b>   <b>A7551</b>
3" hub	3½" hub	4" hub	Large closing plate	Large hub opening adapted to small hub opening	Large Hub opening adapted to small closing plate

### Notes

- **Suffix:** Add to catalog number for factory installation of hub.
- **Packaging:** Individually packed units for field installation.
- **Abbreviations:** H.O. (hub opening), C.P. (closing plate).
- Hub Mast rated



Please consult serving utility for their requirements prior to ordering or installing, as specifications and approvals vary by utility, and may require local electrical inspector approval. All installations must be installed by a licensed electrician and must comply with all national and local codes, laws and regulations. Milbank reserves the right to make changes in specifications and features shown without notice or obligation.

# Accessories

## Connector Kits, Closing Kits & Generator Interlock

### Connector Kits — For Use with 3/8"-16 Stud Type Units Only

Single			Twin		
Suffix	Part #	(3 per set) - 1Ø	Suffix	Part #	(3 per set) - 1Ø
K1	K1539	6-350	K2	K1350	6-350
K3	K1540	4-600 or (2) 1/0-250*	K2L	K1350L	6-350 (non rotating)
K3L	K1540L	4-600 or (2) 1/0-250* (non rotating)	K4	K1541	4-600
Suffix	Part #	(4 per set) - 3Ø	Suffix	Part #	(4 per set) - 3Ø
K5	K3082	6-350	K6	K3442	6-350
K7	K3441	4-600 or (2) 1/0-250*	K8	K3083	4-600

\*For (2) 1/0-250, conductors must be of same size.

### Bypass Link



**K8180** (sold in pairs)

### Note

Consult factory for proper connector kits for studded meter sockets.

### Closing Covers

Meter Closing Plate (Ring Type/Ringless)	Metal Closing Plate (For Ringless Sockets)
<b>6003</b> - Grey Plastic	<b>CP-21</b>
<b>6116</b> - Clear Plastic	
<b>6002</b> - Clear Plastic	

### Disconnect Sleeve



**M5-144**

**Do not use with lever bypass sockets**

### Isolated Neutral Kit



**K1047**

### ANSI-61-Grey

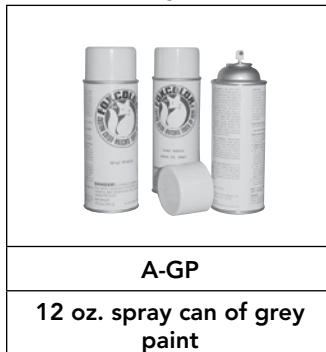

**A-GP**

**12 oz. spray can of grey paint**

### Pole Hanger Kit

850 comes with 4 pole hangers





Catalog Number	Description of pole hanger brackets
<b>850</b>	Two pair (4 pieces) with mounting hardware

Please consult serving utility for their requirements prior to ordering or installing, as specifications and approvals vary by utility, and may require local electrical inspector approval. All installations must be installed by a licensed electrician and must comply with all national and local codes, laws and regulations. Milbank reserves the right to make changes in specifications and features shown without notice or obligation.

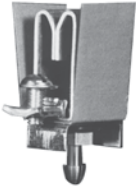

## Fifth Terminals, Tap Connectors & Block Assemblies

### Fifth Terminals

			
<b>5T8K2</b> - 100-200 Amp "Plug-In"	<b>K5T</b> - 200 Amp (Block with Square Hole)	<b>K3865</b> - Heavy Duty Jaw Clamping ( <b>K3866</b> without Neutral Wire)	<b>K3356</b>

### Tap Connectors (3 per set)

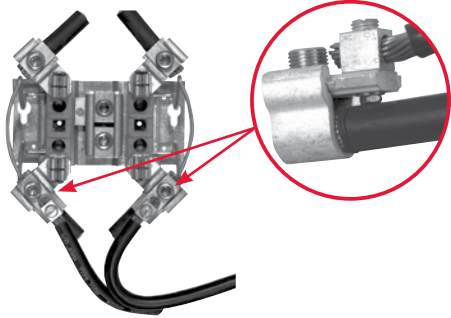
	<p>Replaces the load or line side slide-in nut assembly on Milbank 200 amp sockets. Allows for a 100 amp tap location in addition to the #6-350 kcmil load-side connector. <b>K5022</b> includes safety barrier extensions for applications over 300 VAC. Three lugs per kit.</p>
<b>K4977-INT</b> - Internal Hex	
<b>K4977-EXT</b> - External Hex	
<b>K5022-INT</b> - Internal Hex (set of 4 with barrier) Wire Range #12 - 1/0	

### Triplex Ground

<b>K1190</b> (For factory installed triplex ground, add suffix -TG to catalog number)

### 100 Amp Blocks (single sockets only)

<b>BL7474</b> - Block Assembly
<b>Z904486-AO</b> - Slotted Nut Assembly
<b>Z802965-AC</b> - Neutral without Nut
<b>Z901925-AC</b> - Hex Nut Set Screw

### 200 Amp Blocks (single sockets only)

<b>K4527</b> - Internal Hex Block Assembly (with meter support)
<b>K4528</b> - External Hex Block Assembly (with meter support)
<b>Z916265-AO</b> - Internal Hex Slide Nut Assembly
<b>Z916264-AO</b> - External Hex Slide Nut Assembly
<b>Z814898-AC</b> - Neutral without Nut



Please consult serving utility for their requirements prior to ordering or installing, as specifications and approvals vary by utility, and may require local electrical inspector approval. All installations must be installed by a licensed electrician and must comply with all national and local codes, laws and regulations. Milbank reserves the right to make changes in specifications and features shown without notice or obligation.

# Replacement Receptacle Plates

For Millennium Series RV Products

**45**  
REPLACEMENT  
RECEPTACLE  
PLATES

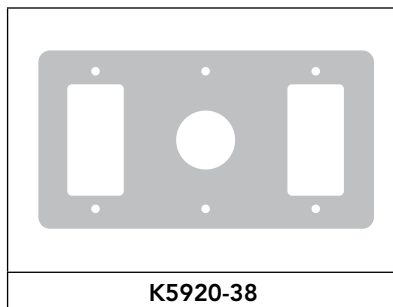
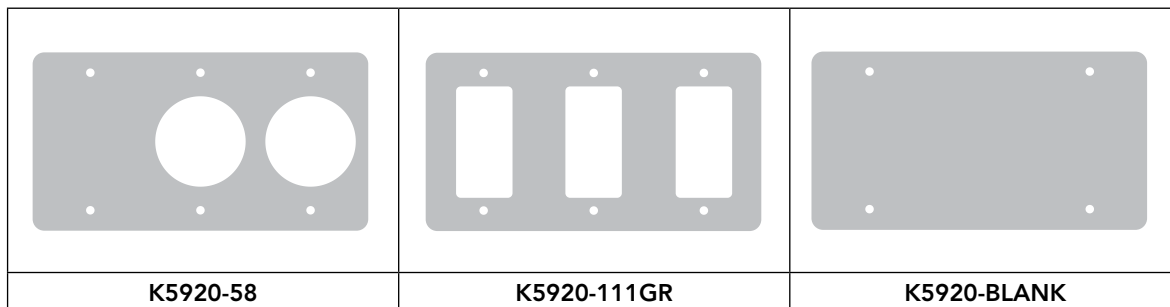
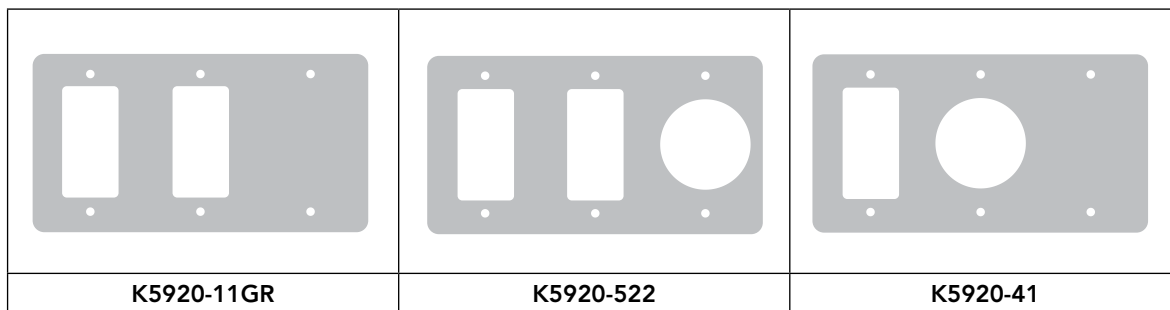
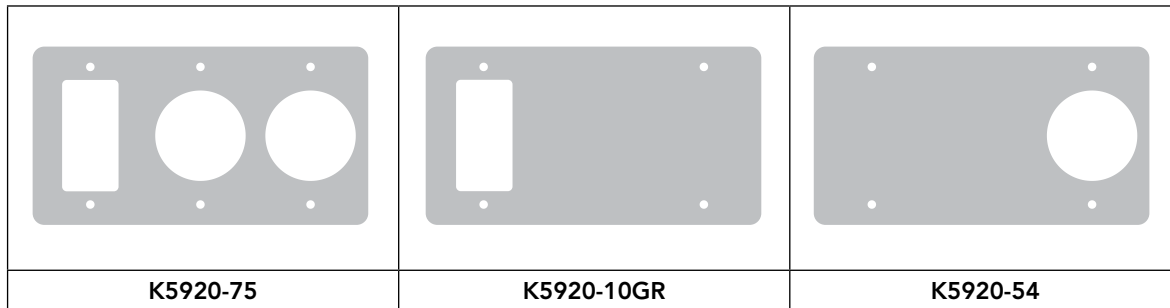

## Notes

- For application details, consult factory.

Please consult serving utility for their requirements prior to ordering or installing, as specifications and approvals vary by utility, and may require local electrical inspector approval. All installations must be installed by a licensed electrician and must comply with all national and local codes, laws and regulations. Milbank reserves the right to make changes in specifications and features shown without notice or obligation.



# Commercial Pedestals

*Attractive | Easy to Install | Secure | Cost-Effective*

**Milbank Commercial Pedestals** are pad-mounted, weather resistant electrical enclosures consisting of a utility pull section with optional meter socket, and a customer section containing distribution and control equipment. Milbank Commercial Pedestals are an attractive, secure, easy to install and cost-effective solution when underground remote site power distribution and control equipment is required, replacing unsightly and inefficient strut and backboard structures.



Strut and backboard



Commercial pedestal

## UL Listed as Industrial Control Equipment (File E113855)

### Standard Features

- Type 3R rain-resistant, vandal-resistant cabinet of polyurethane powder coated steel (aluminum or stainless steel also available)
- UL listed as enclosed industrial control equipment (UL508)
- Isolated lockable and sealable utility metering and lug landing sections
- Lockable customer section for distribution and control equipment with internal deadfront
- Print pocket inside customer section door contains wiring schematics and installation instructions
- Most load centers are UL listed for use with various manufacturers' circuit breakers
- All stainless steel external hardware (screws, bolts, hinges, handles, hasps and sealing screws)

### Note

All meter form and bypass options available to meet utility requirements.

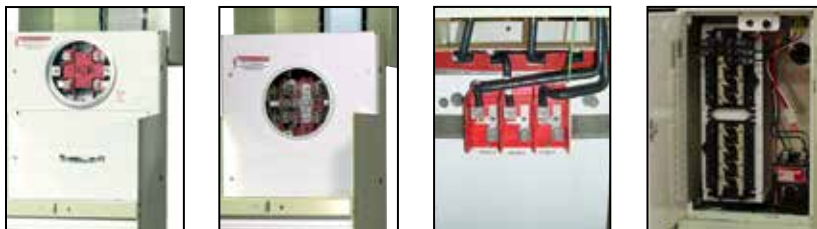

Please consult serving utility for their requirements prior to ordering or installing, as specifications and approvals vary by utility, and may require local electrical inspector approval. All installations must be installed by a licensed electrician and must comply with all national and local codes, laws and regulations. Milbank reserves the right to make changes in specifications and features shown without notice or obligation.

# Commercial Pedestals

Attractive | Easy to Install | Secure | Cost-Effective

**47**  
COMMERCIAL  
PEDESTALS



## Applications

These units are ideal for controlling and metering:

- Traffic signals
- Street lighting
- Power distribution for EV charging stations
- Irrigation and sprinkler systems
- Cell towers and telephone vaults
- Pump stations
- Temporary power for fairgrounds, swap meets, outdoor markets, portable offices, holiday lights, etc.
- Outdoor lighting for athletic fields, tennis and basketball courts, parking lots, landscaping and subdivision entrances, etc.

## Available Factory-Installed Options

- Meter sockets: ring type or ringless, up to 400 amp
- Main and branch breakers or T fuses
- Distribution: copper load centers and panel boards
- Clocks, timers and relays
- Photoelectric cells and controls
- Power receptacles: pin and sleeve, twist lock or straight blade
- Contactors: definite purpose, electrical or mechanically held, IEC and mercury types
- Surge protection and lightning arrestors
- Reserve inlet generator receptacle with interlocked circuit breakers
- Motor starters and relays
- Push button controls
- Thermostat controls, fans and heating strips
- Power blocks and terminal blocks
- Steel, aluminum and plywood backboards
- Transformers
- Interlock devices for circuit breakers
- Available in steel, aluminum (raw painted or anodized) or stainless steel construction with powder coated finish available in eight standard colors or special-ordered RAL colors
- Available for applications up to 400 amp, 120V, 208V, 240V, 277V, 480V - 1Ø or 3Ø

## Accessories



**K3865**  
Fifth terminal kit for use with ringless meter sockets



**CP-ABK5/8**  
Anchor bolt kit (includes four 5/8 - 13 x 18" anchor bolts)



**105J**  
Fifth terminal kit for use with ring type meter sockets



**CP-TC7D**  
7-day time clock kit  
**CP-TC24H**  
24-hour time clock kit  
**CP-TCWIRE**  
Male 4-pin connector and wiring harness for use with time clocks other than above

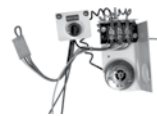

**CP-PE-HOA-3POS**  
HOA switch for field installation



**CP-16PDMNT-CALT**  
16" pedestal mounting base  
**CP-24PDMNT-CALT**  
24" pedestal mounting base (includes mounting hardware)

Please consult serving utility for their requirements prior to ordering or installing, as specifications and approvals vary by utility, and may require local electrical inspector approval. All installations must be installed by a licensed electrician and must comply with all national and local codes, laws and regulations. Milbank reserves the right to make changes in specifications and features shown without notice or obligation.



## CP3B "ML" Series

Main Load Center Series

1Ø3 wire 120/240V or 208Y/120V

Application: remote site service for multiple loads

**Milbank Main Load Center Commercial Pedestals** are designed to handle the vast majority of all requirements in a standard, stocked configuration.

- All units feature a load center with a plug-on, back-fed main breaker.
- Load center has 16 positions for the 100 amp pedestals and 24 circuits for the 200 amp pedestals.
- Both sizes include sub-feed lugs to allow feeding an external panel.

If your application requires turning loads on based on "dusk-to-dawn" requirements, be sure to see the Milbank Switched Load Center Commercial Pedestal products on the following page.

### Features

These units include everything required for remote site service:

- NEMA 3R construction.
- Expandable: load centers allow for future expansion without costly modifications.
- All units feature 200 amp meter socket with optional field installable fifth terminal kit available.
- 22K ampere interrupting capacity (AIC) standard.
- Optional mounting base can be embedded in concrete for fast, easy installation.
- Separate sealable and lockable utility termination section.
- Separate sealable and lockable metering section.
- Separate sealable and lockable customer section with a load center for "always on" loads that include a main circuit breaker, 20 (125 or 200 amp model) or 14 (100 amp model) blank breaker spaces and a circuit directory to document configuration.

**Note**  
All meter form and bypass options available to meet utility requirements.



**Typical Applications**  
Remote site service for multiple loads.

Standard Pedestals	Optional Fifth Terminal Kit	Main CB		Load Center Circuits	Meter Socket Type
		Amp	Spaces		
CP3B51115A22	K3865	100	1,2	16	Ringless socket with lever bypass
CP3B52119A22	K3865	200	1,2,3,4	24	Ringless socket with lever bypass

### Notes

- Chart shows standard, stocked items. Other options and features are available. Contact factory for options, details and availability.



Please consult serving utility for their requirements prior to ordering or installing, as specifications and approvals vary by utility, and may require local electrical inspector approval. All installations must be installed by a licensed electrician and must comply with all national and local codes, laws and regulations. Milbank reserves the right to make changes in specifications and features shown without notice or obligation.



# Commercial Pedestals

Switched Load Center Series | Custom Designs Available

## CP3B "SL" Series

Switched Load Center Series  
1Ø3 wire 120/240V or 208Y/120V

**Note**  
All meter form and bypass options available to meet utility requirements.

**Milbank Switched Load Center Commercial Pedestals** are designed not only to provide power for various loads, but also to switch specific loads on and off under certain conditions. A photoelectric cell is used for these controlled loads, and an optional time clock is also available.

### Features

These units include everything required for remote site service:

- NEMA 3R construction.
- Expandable: load centers allow for future expansion without costly modifications.
- All units feature 200 amp meter socket with optional field installable fifth terminal kit available.
- 22K amp interrupting capacity (AIC) standard.
- Optional mounting base can be embedded in concrete for fast, easy installation.
- Separate sealable and lockable utility termination section.
- Separate sealable and lockable metering section.
- Separate sealable and lockable customer section with a control circuit including PE receptacle, Lexan® window, glare shield, Hand-Off-Auto (HOA) switch, contractor controlling a 16-circuit load center for controlled loads, a pre-mounted DIN rail and pre-wired connector to add an optional "plug-and-play" time clock kit for PE on and TC off operation and a circuit directory to document configuration.
- A load center for "always on" loads that includes a main circuit breaker, a control power circuit breaker, a switched load center main breaker, nine (125 or 200 amp model) or 11 (100 amp model) blank breaker spaces and a circuit directory to document configuration.



**Typical Applications**  
Traffic signals, parking lots, highways & athletic field lighting

Standard Pedestals	Optional Fifth Terminal Kit	Main CB		Contactor Amperage	Meter Socket Type
		Amp	Spaces		
CP3B51110A22SL1	K3865	100	1,3	60	Ringless socket with lever bypass
CP3B52110A22SL1	K3865	200	1,2,3,4	100	Ringless socket with lever bypass

### Notes

- Chart shows standard, stocked items. Other options and features are available. Contact factory for options, details and availability.

Please consult serving utility for their requirements prior to ordering or installing, as specifications and approvals vary by utility, and may require local electrical inspector approval. All installations must be installed by a licensed electrician and must comply with all national and local codes, laws and regulations. Milbank reserves the right to make changes in specifications and features shown without notice or obligation.



# Commercial Pedestals

## CP3B "400" 400 Amp Series



**Milbank 400 Amp Commercial Pedestals** are designed to provide a weather and vandal resistant metered enclosure for various loads and distribution. Each pedestal has been designed to handle a wide range of applications using standard, stocked configurations.

- Choice of a single main breaker or twin service disconnect breakers gives flexibility to the pedestal design.
- Optional distribution with feed-through lugs below the service disconnect breakers allows the pedestal to handle numerous applications.
- Typical applications include remote homes where the metering is best located at the curb side or other remote area. The pedestal can also provide power to secondary residence, on-site business, workshop, irrigation, lighting, security or other secondary load.
- Available in custom colors to match home or landscaping.

### Features

These units include everything required for remote service:

- Type 3R construction
- Main circuit breaker or dual service disconnects
- Expandable: load center units allow for future expansion without costly modifications
- Optional mounting base can be embedded in concrete for fast, easy installation
- Separate sealable and lockable utility termination section with lug termination
- Separate sealable and lockable metering section
- A separate sealable and lockable customer section with a circuit directory and a print pocket to hold all documentation
- Meter socket options include ring type with bypass studs, ringless with heavy duty lever bypass, or K-Type bolt-on

### Typical Applications

Remote site service for residential and commercial job sites.

Standard Pedestals	Optional fifth Terminal Kit	Main CB	Load Center Circuits	Meter Socket Type
CP3B54120B22	K3865	2-200 amp	(2) 12 circuit	Ringless with lever bypass
CP3B5411JB22	K3865	320 amp (400 max)	0	Ringless with lever bypass

### Notes

- Chart shows standard, stocked items. Other options and features are available. Contact factory for options, details and availability.
- Stud utility landing is standard. Lug kits are available from factory.
- Units with load centers have (2) #6-250 sub-feed lugs on each load center. (Each load center is 200 amp rated and UL listed with: Siemens, General Electric and Cutler-Hammer plug-in style circuit breakers.)



Please consult serving utility for their requirements prior to ordering or installing, as specifications and approvals vary by utility, and may require local electrical inspector approval. All installations must be installed by a licensed electrician and must comply with all national and local codes, laws and regulations. Milbank reserves the right to make changes in specifications and features shown without notice or obligation.

# Commercial Pedestals

## CP3B "IR" Irrigation Control Series



**Milbank "IR" Series Irrigation Pedestals** install quickly and simply – often in less than an hour with a single technician – a fraction of the time typically needed for strut farm and other installation set ups. Additionally, the pedestal comes pre-wired, so the technician simply drops in the pre-drilled concrete box pad, fastens the pedestal and runs the wires. Prewired landing lugs are provided in a separate utility side so that there is no more need to wrestle with hard-to-bend wires. Simply run the utility wire up and land on the lugs. With both the motor starter and disconnect in the same enclosure, all the controls are housed in a safe, lockable pedestal that protects against vandalism and energy theft.

### Features

- 3Ø4W, 480Y/277 volt
- One technician can install in under an hour with use of Milbank's pre-drilled box pad
- All units are UL listed and service entrance rated
- Fused disconnect with accessible handle through the deadfront
- HOA and push button start
- Separate accessible utility side with pre-wired landing lugs
- NEMA rated starters (sizes 1-5)
- Soft start units sizes 30HP-150HP
- 30 amp fuse block for pivot pre-wired in the unit
- White powder coated paint finish helps keep components cooler
  - Options include:
    - Hour meter
    - Chemical injection receptacle
    - Multiple injection receptacle
    - Multiple 30 amp fuse blocks possible

### Typical Applications

Power pedestal for irrigation systems or other pump control applications.

Standard Pedestals	Exterior Cabinet	NEMA Rating
CP3B0281UMWIR04	White	4
CP3B0281UMWIR03	White	3
CP3B0181UMWIR02	White	2

### Notes

- Chart shows standard, stocked items. Other options and features are available. Contact factory for options, details and availability.

Please consult serving utility for their requirements prior to ordering or installing, as specifications and approvals vary by utility, and may require local electrical inspector approval. All installations must be installed by a licensed electrician and must comply with all national and local codes, laws and regulations. Milbank reserves the right to make changes in specifications and features shown without notice or obligation.



# Commercial Pedestals

## CP3B "BBS" Battery Backup Series



**Milbank BBS Series Commercial Pedestals** are designed to provide battery backup power for various loads, and to switch specific loads on and off under certain conditions; a photoelectric cell or time clock to control lighting circuits, as an example. Metered and unmetered power distribution options are available. The back-up power pedestal is designed to handle the vast majority of today's back-up power requirements. By using 19" rack design, shelves can be adjusted to accommodate the required batteries and manufactures DC to AC inverters, transfer switches and other related equipment. This design gives the user a wide range of design and configuration options. Complete turnkey, ready to power-up pedestals are offered along with basic units ready to accept batteries and inverters supplied by others.

### Features

- Type 3R construction
- 100 through 320 amp meter socket with the option of either a ring type socket (conforms to EUSERC 308) with or without test/bypass blocks or a heavy duty ringless socket with lever bypass
- Separate sealable utility termination compartment
- An isolated separate customer section with service disconnects, power distribution options and power control
- 19" wide rack in customer compartment for easy layout of equipment
- Battery trays
- Thermostat with cooling fan
- Filtered louvers for heat rise flow through ventilation
- Three point door latch (key or pad lockable)

### Typical Applications

Metered emergency uninterrupted power for traffic intersections, wireless, phone and communications equipment, parking lots, camera and security locations.

### Options

- Manual bypass switch
- Transfer switch for generator power back-up
- Generator inlet receptacles 30 amp through 200 amp
- Pad lockable provision for receptacles
- Police access door
- Metered load center distribution
- Unmetered load center distribution
- Photo electric controls (for street lighting)
- Time clocks
- HOA switches
- Contactors
- GFI duplex receptacles
- Thermostat for heating control
- Heating pads or elements
- Roll out shelves for batteries
- Surge arrestors and lighting arrestors



Please consult serving utility for their requirements prior to ordering or installing, as specifications and approvals vary by utility, and may require local electrical inspector approval. All installations must be installed by a licensed electrician and must comply with all national and local codes, laws and regulations. Milbank reserves the right to make changes in specifications and features shown without notice or obligation.

# Commercial Pedestals

## CP3B "Power Transfer" Series



**Milbank Power Transfer Series Pedestals** provide unmetered AC power, distribution, surge suppression, mechanical interlock and stand-by generator receptacle all in a neat, compact pedestal.

### Features

- 120/240V 1Ø3W through 277/480V 3Ø4W ratings
- Metered or unmetered units
- Choice of EUSERC ring type or ringless meter sockets
- 60 amp through 400 amp ratings
- UL listed Type 3R rated
- Pad lockable, isolated utility compartments
- 20 amp GFI convenience receptacle
- Lockable recessed generator receptacle door
- Utility and generator indicator light options
- All stainless steel hardware
- Galvanized steel, aluminum or stainless steel cabinet options
- Custom designs available



### Typical Applications

Traffic intersections, cell sites, cable TV, pump and lift stations requiring utility power with backup generator power

Please consult serving utility for their requirements prior to ordering or installing, as specifications and approvals vary by utility, and may require local electrical inspector approval. All installations must be installed by a licensed electrician and must comply with all national and local codes, laws and regulations. Milbank reserves the right to make changes in specifications and features shown without notice or obligation.



# Commercial Pedestals

## CP3BB "CT Metered" Series



**Milbank CT Metered Series Commercial Pedestals** are designed to be used where a smaller service package would be a better choice over large 3R rated combination switchboards. These pedestals have amperage ratings of 400 to 800 amp at voltages up through 480 volt three phase.

### Features

- UL listed, freestanding Type 3R service
- A low profile CT pedestal
- All utility equipment is isolated in separated pad lockable and sealable compartments
- Separate customer compartment designed to hold distribution and control equipment
- Dead front customer construction
- Optional mounting base
- Optional construction in steel, aluminum and stainless steel.
- Wide choice of powder paint colors

### Typical Applications

Large homes, pumping and lift stations, motor control, water treatment plants, EV charging stations, commercial buildings, large remote service requirements, commercial and industrial control systems.



Please consult serving utility for their requirements prior to ordering or installing, as specifications and approvals vary by utility, and may require local electrical inspector approval. All installations must be installed by a licensed electrician and must comply with all national and local codes, laws and regulations. Milbank reserves the right to make changes in specifications and features shown without notice or obligation.

# Commercial Pedestals

## CP3A "Slimline" Series



**Milbank Slimline Series Commercial Pedestals** provide a sleeker, smaller footprint, with wireway access on the side of the unit rather than the back, allowing maximum flexibility to place the pedestal in tighter spaces.

### Features

- UL listed as service equipment
- 100 or 200 amp
- Vandal-resistant, secure and attractive design
- Customer compartment with distribution and control equipment with swing dead front door, secured with both a hasp/latch and draw latch outer door
- Utility metering compartment protected with a hinged hood, increasing resistance to meter vandalism
- Small footprint
- Wireway located on left side of pedestal for utility incoming wire, allowing pedestal to be mounted with back very close to a wall (14")
- Available in 12" and 20" widths and 50" and 63" (metered) and 43" (unmetered) heights
- Includes a print pocket for plans and drawings
- 200 amp main available
- Voltage range: 120V–480V
- Compatible with both ringless and ring type meter sockets, 4–7 terminals
- Available in a wide array of colors, including but not limited too all ANSI powder coated paint colors upon request
- Pedestal mounting base option saves time and labor to install on a cement pad—no anchor bolts required
- Powder coated G90 galvanized steel, raw, anodized or powder coated aluminum and stainless steel exterior options

### "Slimline" Series Direct Bury Extension

- No need for concrete
- Bolts directly to unit
- Easy, modular design
- Ships in a smaller package
- Increases project flexibility
- Easier to handle and install
- Utilizes stabilizer feet to prevent leaning over time
- Pedestal and extension can be installed within 45 minutes

### Typical Applications

Roadway lighting and signage, wastewater treatment facilities, parks and landscaping, and any application where physical space is at a premium



### Notes

- 14 guage steel
- Only available for 12" pedestals

Please consult serving utility for their requirements prior to ordering or installing, as specifications and approvals vary by utility, and may require local electrical inspector approval. All installations must be installed by a licensed electrician and must comply with all national and local codes, laws and regulations. Milbank reserves the right to make changes in specifications and features shown without notice or obligation.



## NEMA Commercial Enclosures

Milbank's line of commercial enclosures includes the full gamut of styles and sizes; everything from junction boxes to transformer cabinets, telephone cabinets to wireway.

### Type 1 Enclosures

Milbank's Type 1 enclosures are designed for indoor use to provide a degree of protection to personnel against access to hazardous parts and to provide a degree of protection of the equipment inside the enclosure against ingress of solid foreign objects, such as falling dirt.

### Type 3R Enclosures

Milbank's Type 3R enclosures are designed for either indoor or outdoor use to provide a degree of protection from harmful effects on the equipment due to the ingress of water (rain, sleet, snow) and that will be undamaged by the external formation of ice on the enclosure.

### Wireway

Milbank's wide range of wireway is available in many styles and sizes and its wide range of fittings allows it to smoothly transition to and from competitors' products.



## NEMA Industrial Enclosures

Milbank's line of industrial enclosures include junction boxes, wiring trough, push-button enclosures and modular enclosures. Milbank also excels in special designs; nearly any type, size or color of enclosure you need, we can make!

### Type 12 Enclosures

Enclosures constructed without knockouts for indoor use to provide a degree of protection to personnel against access to hazardous parts, and protect components against falling dirt, circulating dust and lint, and dripping or splashing water.

### Type 4 Enclosures

Enclosures constructed for either indoor or outdoor use to provide a degree of protection to personnel against access to hazardous parts; protect equipment against falling dirt and windblown dust; protect against rain, sleet, snow, splashing water, and hose directed water; and is resistant to damage by the external formation of ice on the enclosure.

### Industrial Enclosure Specials

Milbank specializes in custom enclosure projects, offering an almost limitless amount of styles, options, colors and sizes. Milbank will meet your needs and specifications and deliver a custom enclosure that protects your crucial electric equipment.

### Thermal Management

Protect components housed in enclosures from damage caused by overheating, freezing, humidity and condensation with these thermal management products.



Please consult serving utility for their requirements prior to ordering or installing, as specifications and approvals vary by utility, and may require local electrical inspector approval. All installations must be installed by a licensed electrician and must comply with all national and local codes, laws and regulations. Milbank reserves the right to make changes in specifications and features shown without notice or obligation.



# Watt-hour Meter Forms

Standard Forms | Transformer Rated or Self-Contained

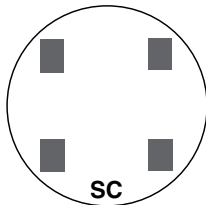

**SC**  
2 and 3-WIRE FORMS  
1S & 2S

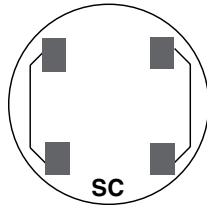

**SC**  
2 and 3-WIRE FORMS  
1S & 2S with BYPASS

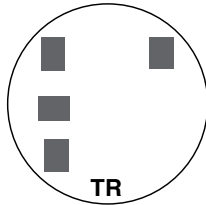

**TR**  
2-WIRE FORM 3S  
5th Term. 9 o'clock

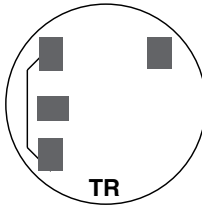

**TR**  
2-WIRE FORM 3S  
with BYPASS

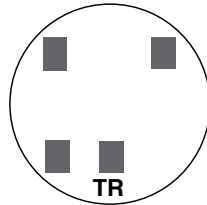

**TR**  
2-WIRE FORM 3S  
5th Term. 6 o'clock

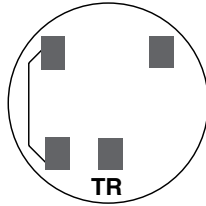

**TR**  
2-WIRE FORM 3S  
with BYPASS

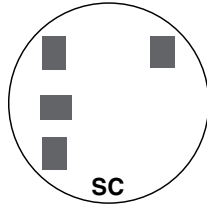

**SC**  
2 ELEMENT  
3-WIRE NETWORK  
FORM 12S 5th  
TERM. 9 o'clock

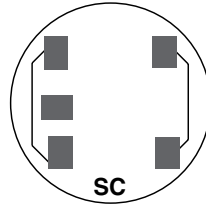

**SC**  
2 ELEMENT 3-WIRE  
NETWORK FORM 12S  
with BYPASS  
5th Term. 9 o'clock

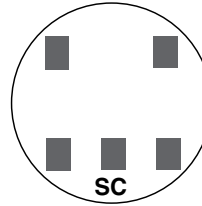

**SC**  
2 ELEMENT  
3-WIRE NETWORK  
FORM 12S 5th  
TERM. 6 o'clock

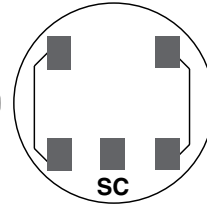

**SC**  
2 ELEMENT 3-WIRE  
NETWORK FORM 12S  
with BYPASS  
5th Term. 6 o'clock

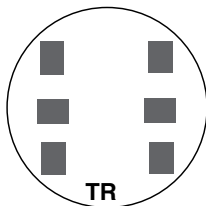

**TR**  
3-WIRE FORM 4S

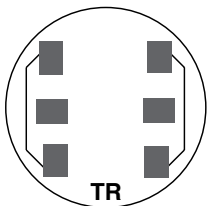

**TR**  
3-WIRE FORM 4S  
WITH BYPASS

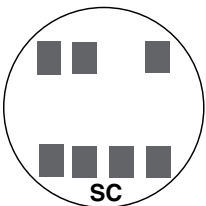

**SC**  
2 or 3 ELEMENT  
3Ø4W Y or  
Y FORM 14S  
FORM 15S  
Y FORM 16S

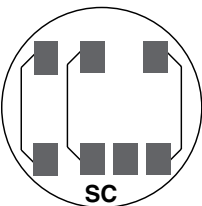

**SC**  
2 or 3 ELEMENT  
3Ø4W Y or  
FORMS 14S & 15S  
with BYPASS

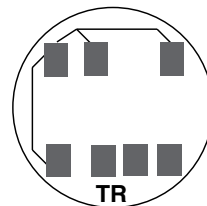

**TR**  
2 ELEMENT  
3Ø4W Y or  
Y FORM 7S  
FORM 24S  
with BYPASS

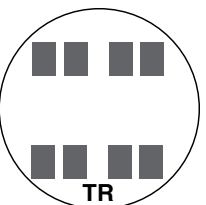

**TR**  
2 ELEMENT  
2Ø3W, 2Ø4W, 3Ø3W  
FORM 5S

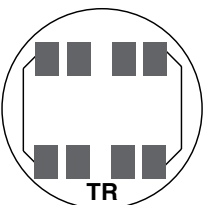

**TR**  
2 ELEMENT 3Ø3W,  
2Ø4W, 3Ø3W  
FORM 5S with  
BYPASS

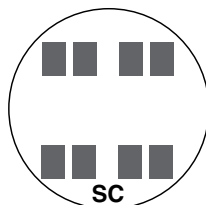

**SC**  
2 ELEMENT  
2Ø3W, 2Ø4W, 3Ø3W  
FORM 13S

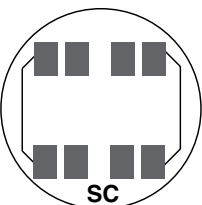

**SC**  
2 or 3 ELEMENT  
2Ø3W, 2Ø4W, 3Ø3W  
FORM 13S with  
BYPASS

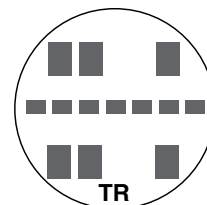

**TR**  
2 or 3 ELEMENT  
3Ø4W Y or  
Y FORM 9S  
FORM 8S

TR = TRANSFORMER RATED  
SC = SELF CONTAINED

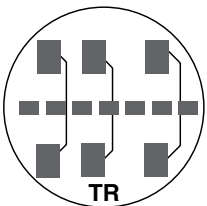

**TR**  
2 or 3 ELEMENT  
3Ø4W Y or  
FORMS 8S & 9S  
FORMS 8S & 9S  
with BYPASS

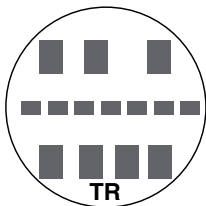

**TR**  
2 ELEMENT  
3Ø4W Y  
FORM 6S

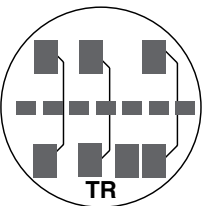

**TR**  
2 ELEMENT  
3Ø4W Y  
FORM 6S  
with BYPASS

Please consult serving utility for their requirements prior to ordering or installing, as specifications and approvals vary by utility, and may require local electrical inspector approval. All installations must be installed by a licensed electrician and must comply with all national and local codes, laws and regulations. Milbank reserves the right to make changes in specifications and features shown without notice or obligation.



**DIAGRAM A**  
1 $\emptyset$ 2W with 1 P.T. & 1 C.T.  
Single Stator Meter(2W1 $\emptyset$ ) - Form 3S  
5T Socket, Test Switch #TS04-0101

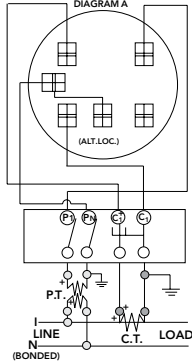

**DIAGRAM B**  
1 $\emptyset$ 3W with 1 C.T.  
Single Stator Meter (2W1 $\emptyset$ ) - Form 3S  
5T Socket, Test Switch #TS04-0101

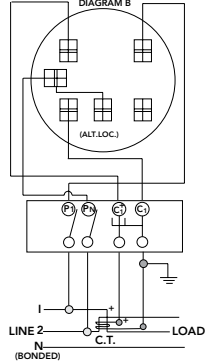

**DIAGRAM C**  
1 $\emptyset$ 3W with 2 C.T.'s  
Single Stator Meter (3W1 $\emptyset$ ) - Form 4S  
6T Socket, Test Switch #TS07-0105

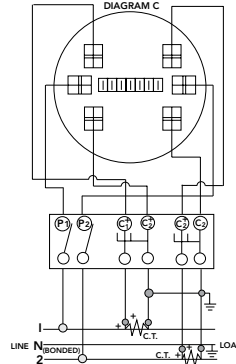

**DIAGRAM D**  
1 $\emptyset$ 3W or 3W Network with 2 C.T.'s  
2 Stator Meter - Form 5S  
8T Socket, Test Switch #TS07-0105

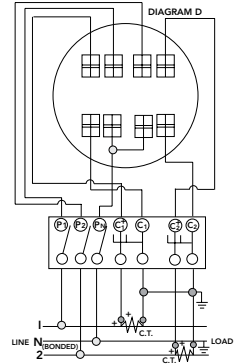

**DIAGRAM E**  
3 $\emptyset$ 3W "A" with 2 P.T.'s & 2 C.T.'s  
2 Stator Meter - Form 5S  
8T Socket, Test Switch #TS07-0105

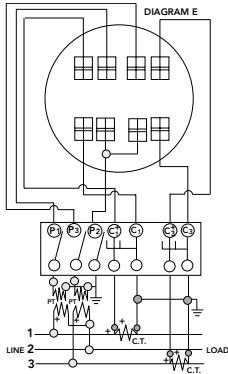

**DIAGRAM F**  
3 $\emptyset$ 3W "A" with 2 C.T.'s  
2 Stator Meter - Form 5S  
8T Socket, Test Switch #TS07-0105

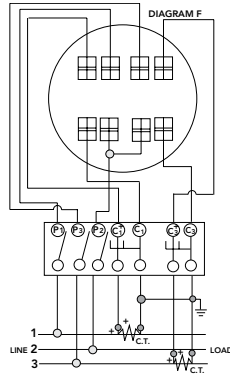

**DIAGRAM G**  
3 $\emptyset$ 4W "Y" with 3 C.T.'s  
2 1/2 Stator Meter - Form 6S  
13T Socket, Test Switch #TS10-0109

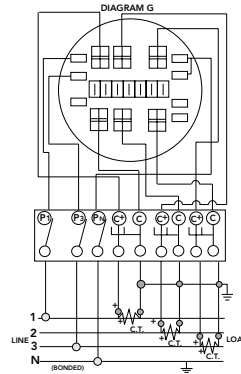

**DIAGRAM H**  
3 $\emptyset$ 4W "Y" with 2 P.T.'s & 3 C.T.'s  
2 1/2 Stator Meter - Form 6S  
13T Socket, Test Switch #TS10-0109

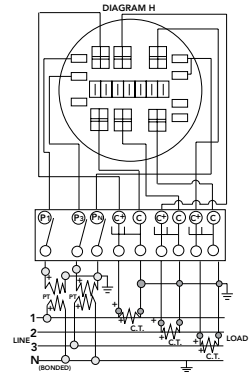

**DIAGRAM I**  
3 $\emptyset$ 4W "Y" or "A" with 3 C.T.'s  
"Y" 3 Stator Meter - Form 9S  
"A" 2 Stator Meter - Form 8S  
13T Socket, Test Switch #TS10-0109

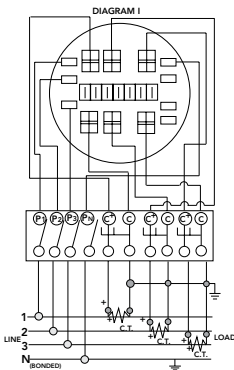

**DIAGRAM J**  
3 $\emptyset$ 4W "Y" with 3 P.T.'s & 3 C.T.'s  
3 Stator Meter - Form 9S  
13T Socket, Test Switch #TS10-0109

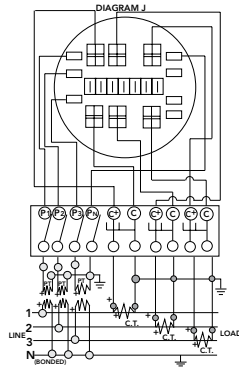

**Prewiring:** If standard factory prewiring is required, refer to wiring diagrams on this page. Determine appropriate diagram and send a copy with order. If custom factory prewiring is required, specify on order. Be sure to include meter socket catalog number, test switch make and catalog number, meter form number and provide a copy of your wiring diagram.



Please consult serving utility for their requirements prior to ordering or installing, as specifications and approvals vary by utility, and may require local electrical inspector approval. All installations must be installed by a licensed electrician and must comply with all national and local codes, laws and regulations. Milbank reserves the right to make changes in specifications and features shown without notice or obligation.

# Conduit, Ampacity & SCCR

## Reference Information

### MAXIMUM NUMBER OF CONDUCTORS IN CONDUIT

Table from 2008 NEC Code Reference: Rigid Metal Conduit

Type	Conductor Size (AWG/kcmil)	Conduit Trade Sizes (Inches)									
		½	¾	1	1¼	1½	2	2½	3	3½	4
THHN, THWN, THWN-2	12	9	16	26	46	62	102	146	225	301	387
	10	6	10	17	29	39	64	92	142	189	244
	8	3	6	9	16	22	37	53	82	109	140
	6	2	4	4	12	16	27	38	59	79	101
	4	1	2	4	7	10	16	23	36	48	62
	3	1	1	3	6	8	14	20	31	41	53
	2	1	1	3	5	7	11	19	26	34	44
	1	1	1	1	4	5	8	12	19	25	35
	1/0	1	1	1	3	4	7	10	16	21	27
	2/0	0	1	1	2	3	6	8	13	18	23
XHH, XHHW, XHHW-2	3/0	0	1	1	1	3	5	7	11	15	19
	4/0	0	1	1	1	2	4	6	9	12	16
	4	1	2	4	7	10	16	24	37	49	63
	2	1	1	3	5	7	12	17	26	35	45
	1/0	1	1	1	3	4	7	10	16	22	28
	2/0	0	1	1	2	3	6	9	13	18	23
	4/0	0	1	1	1	2	4	6	9	12	16
	250	0	0	1	1	1	3	5	7	10	13
	350	0	0	1	1	1	2	3	6	7	10
	500	0	0	0	1	1	1	2	4	5	7
750	0	0	0	0	1	1	1	3	4	5	

This table is for concentric stranded conductors only. For cables with compact conductors refer to NEC. Refer to latest NEC Code or Local Codes for updated requirements.

#### \* ALLOWABLE AMPACITIES OF INSULATED COPPER & \*\* ALUMINUM CONDUCTORS (3W IN CONDUIT) 75°C (167°F)

*CU		AL or **Cu-Clad AL	
A	B	A	C
18	-	-	-
16	-	-	-
14	20†	-	-
12	25†	12	20†
10	35†	10	30†
8	50	8	40
6	65	6	50
4	85	4	65
3	100	3	75
2	115	2	90
1	130	1	100
1/0	150	1/0	120
2/0	175	2/0	135
3/0	200	3/0	155
4/0	230	4/0	180
250	255	250	205
300	285	300	230
350	310	350	250
400	335	400	270
500	380	500	310
600	420	600	340
700	460	700	375
750	475	750	385

A = Size: AWG/MCM  
 \*B = Ampere Rating for Insulation Types:  
**FEPW, RH, RHW, THW, THWN, XHHW, USE, 2W.**  
 \*\*C = Ampere Rating for Insulation Types:  
**RH, RHW, THW, THWN, XHHW, USE**  
 (Per NEC table 310-16)

#### AMPACITY CORRECTION FACTORS

AMBIENT TEMP.°	CORRECTION FACTOR	AMBIENT TEMP.°
21 - 25	1.05	70 - 77
26 - 30	1.00	78 - 86
31 - 35	.94	87 - 95
36 - 40	.88	96 - 104
41 - 45	.82	105 - 113
46 - 50	.75	114 - 122
51 - 55	.67	123 - 131
56 - 60	.58	132 - 140
61 - 65	.33	141 - 158

Overall ampere ratings of U/L listed Milbank multiple position meter sockets are based on 2008 N.E.C. Handbook Article 220-84 and ANSI / UL-414 (except where restricted by line connector size.) These requirements provide for a diversity factor / demand factor being utilized in determining the overall (main bus / lug) rating of a gang socket. All Milbank U/L listed gang sockets meet or exceed these diversity factor/demand factor requirements. Standard overall ampacity ratings for U/L listed and non U/L listed gang sockets are as shown in the chart below. Ampere ratings of meter sockets are based on the meter socket being wired with 75° C insulated wire conductor, sized in accordance with Table 310-16 of the National Electric Code.

#### GANG SOCKET OVERALL AMPACITIES

NO. OF METER POSITIONS	100A / POS. AMPACITY	125A / POS. AMPACITY	150A / POS. AMPACITY	200A / POS. AMPACITY
2	200A	200A	200A	200A #
3	200A	225A	225A	270A
4	200A	250A	270A	360A
5	225A	285A	338A	450A
6	270A	330A	396A	528A

† Unless otherwise permitted elsewhere in the Code, the overcurrent protection for conductor types marked with an obelisk (†) shall not exceed 15 amps for 14 AWG, 20 amps for 12 AWG, and 30 amps for 10 AWG copper; or 15 amps for 12 AWG and 25 amps for 10 AWG aluminum and copper-clad aluminum after any correction factors for ambient temperature and number of conductors have been applied.

# Some constructions are rated at 400 amps overall. Contact your sales representative for more information. Refer to latest NEC Code or Local Codes for updated requirements.

Please consult serving utility for their requirements prior to ordering or installing, as specifications and approvals vary by utility, and may require local electrical inspector approval. All installations must be installed by a licensed electrician and must comply with all national and local codes, laws and regulations. Milbank reserves the right to make changes in specifications and features shown without notice or obligation.



### Important Note

In addition to national and local electrical codes, many utilities have specific requirements for metering equipment. Always consult the serving utility for their specifications and requirements prior to ordering or installing Milbank meter mounting equipment.

### Before Energizing

1. Give equipment a thorough visual examination to determine that:
  - A. No shipping or installation damage exists.
  - B. Proper clearances have been maintained.
  - C. All connections have been made.
  - D. Equipment is clean and dry.
2. Make a thorough examination to:
  - A. Verify tightness of all bolted connections (see table below).
  - B. Manually operate all circuit breakers, switches, relays, etc.
  - C. Check rigidity of all mountings, bus bars and components.
  - D. Use test equipment to check continuity of circuitry and integrity of insulation.
3. All switches and circuit breakers should be in the "off" position.
4. Verify that manual meter bypass (if applicable) is in non-bypass position.
5. Install cover and/or close doors.
6. If installation is not being energized at this time, follow "after-energizing" steps listed below. These steps will secure the installation in case of accidental energization.

### When Energizing

Use caution and follow established safety procedures:

- 1) Wear safety apparel.
- 2) Use safety equipment.
- 3) Take action to prevent injury to yourself and others in the event of failure of the installation.
- 4) Take action to prevent/decrease damage to property in the event of failure of the installation.
- 5) If you are unsure how to safely energize the installation, get someone who is knowledgeable to do it.

### After Energizing

Secure the installation:

- 1) To prevent accidental contact with energized parts, cover all openings with approved filler devices.
- 2) To prevent unauthorized access, secure all covers and/or doors with approved security devices.
- 3) Attach/post information to advise others of potential hazards associated with the installation.

### Recommended Torque for General Applications\*

Nominal Size	Joint Description		Head Type	Torque (Inch Lbs.)
	Screw	Nut		
10	Brass	Brass Nut or Extruded Hole	All	20-25 inch lbs.
10	Steel	Copper or Aluminum Busbar ≤ 1/8"	All	25-30 inch lbs.
10	Steel	Steel Nut or Extruded Hole; CU or AL Busbar > 1/8"	All	30-35 inch lbs.
12	Steel	Aluminum Extruded Hole	All	30-35 inch lbs.
12	Steel	Steel Nut or Extruded Hole	All	40-50 inch lbs.
1/4	Steel	Aluminum Extruded Hole	All	40-50 inch lbs.
1/4	Steel	Steel Nut or Extruded Hole; CU or AL Busbar	All	50-60 inch lbs.
5/16	Steel	Aluminum Extruded Hole	Hex	60-70 inch lbs.
5/16	Steel	Steel Nut or Extruded Hole; CU or AL Busbar	Hex	100-150 inch lbs.
3/8	Steel	Steel Nut	Hex	150-200 inch lbs.
1/2	Steel	Steel Nut	Hex	200-250 inch lbs.

\* Interior labels typically indicate the required torque for wire connectors and studs, and should be referenced first.  
**CU:** Copper  
**AL:** Aluminum



Please consult serving utility for their requirements prior to ordering or installing, as specifications and approvals vary by utility, and may require local electrical inspector approval. All installations must be installed by a licensed electrician and must comply with all national and local codes, laws and regulations. Milbank reserves the right to make changes in specifications and features shown without notice or obligation.

## Materials

### Steel Quality

---

The meter equipment listed in this catalog is made of galvanized steel (AISI\* G90) to afford the best possible weather proofing.  
\*American Iron and Steel Institute.

### Steel Sheet

---

16 gauge, galvanized, sheet: 1 1/4 oz./ sq.ft. class zinc-coated. (AISI G90)  
14 gauge, galvanized, sheet: 1 1/4 oz./ sq.ft. class zinc-coated.

### Aluminum Extrusion

---

Wire-Terminals: Alloy; 6061-T6, Tin-plated for CU/AL wire.  
Bus Bar: Alloy; 6101-O & 6063-O

### Aluminum Sheet

---

3000 series aluminum sheet, H14, or 5052 series aluminum sheet, H32. Where applicable thicknesses range from .064-.125

### Copper Sheet & Bus

---

Electrolytic copper with tin plating in most applications.

### Insulating Materials

---

- In most units, support bases for current-carrying components are molded from fiberglass reinforced high-strength, track resistant, thermoset polyester molding compounds.
- Clear or black safety shields and polarity barriers are molded from high-strength, track resistant, polycarbonate molding compounds.
- Various sheet insulating materials, as appropriate for the application are utilized in the fabrication of flat, formed and punched component parts and barriers.

## Finish

### Process

---

Light gray state-of-the-art electrostatically applied powder paint offers a durable, non-fading finish. For further information concerning the chemical analysis of the weather resistant finish, please contact the factory.

### Metal Fasteners

---

Zinc-coated with a chromate dip.

## Ratings & Compliance

### Ratings & Compliance

---

All Milbank electrical enclosures in this catalog are rated "Type 3R Enclosure" unless specified otherwise on the product's page. All enclosures with a UL designation are constructed per the appropriate UL Standard and may be installed per the National Electric Code. UL procedure files associated with the UL Standards are listed as follows: Meter Sockets (UL 414, File E30202), Test Switches (UL 414, File E62531), Power Outlets (UL 231, File E90945), Panelboards (UL 67, File E32628) and Pullout Switches (UL 1429, File E133062). Additional standards are utilized as applicable: Meter Sockets (ANSI C12.7), Test Switches (ANSI C12.9) and Panelboards (NEMA PB-1).

Please consult serving utility for their requirements prior to ordering or installing, as specifications and approvals vary by utility, and may require local electrical inspector approval. All installations must be installed by a licensed electrician and must comply with all national and local codes, laws and regulations. Milbank reserves the right to make changes in specifications and features shown without notice or obligation.



# Utility Approval List

Catalog Number	AEP	First Energy	DP&L
U7487-RL-TG-KK		X	X
U7487-RL-TG-KK-BLG	X		
U7021-RL-TG-KK		X	X
U7021-RL-TG-KK-BLG	x		
U7040-RL-TG-KK		X	
U7040-RL-TG-KK-BLG	X		
U7040-XL-TG-KK		X	
U1980-O-KK		X	X
U1980-O-KK-BLG	X		
U9551-RRL		X	X
U9701-RRL		X	
U9701-RRL-BLG	X		
U1079-RRL-K3		X	X
U4905-X		X	
U4905-X-BLG	X		
U1129-O-K3L-K2L		X	X
U5161-X-K3L-K2L-BLG	X		
U1797-O-K3L-K2L		X	
U1797-O-K3L-K2L-BLG	X		
U2594-X		X	
U2594-X-K7-K6-BLG	X		
U2594-X-BLG	X		
U3989-XL		X	
U5844-PXL-200-KK		X	X
U5844-PXL-200-KK-BLG	X		
USE-22-200-MB		X	
U5168-XTL-100-KK		X	
U5168-XTL-100-KK-BLG	X		
U5168-XTL-150-KK		X	
U5168-XTL-150-KK-BLG	X		
U5168-XTL-200-KK		X	X
U5168-XTL-200-KK-BLG	X		
U5268-XTL-150-KK		X	
U5268-XTL-200-KK		X	
U5268-XTL-200-KK-BLG	X		
U5871-XL-200		X	
U5890-X-2/200-BL	X	X	
U5890-X-2/200-BLG	X	X	
U5891-X-2/200-MLK-BL	X	X	
U1232-RRL-KK-K1		X	
U1233-RRL-KK-K1		X	
U1234-RXL-KK-K1		X	
U1252-RRL-KK-K1-SLVG		X	
U1252-RRL-KK-K1-BLG-SLVG	X		

Catalog Number	AEP	First Energy	DP&L
U1253-RRL-KK-K1-SLVG		X	
U1253-RRL-KK-K1-BLG-SLVG	X		
U1254-RXL-KK-K1-SLVG		X	
U1254-RXL-KK-K1-BLG-SLVG	X		
U1255-RXL-KK-K1-SLVG		X	
U1255-RXL-KK-K1-BLG-SLVG	X		
U1256-RXL-KK-K1-SLVG		X	
U1256-RXL-KK-K1-BLG-SLVG	X		
U2872-XT		X	
U2873-XT		X	
U2874-XT		X	
U2875-XT		X	
U2876-XT		X	
U2732-XT		X	
U2733-XT		X	
U2734-XT		X	
U2735-XT		X	
U2736-XT		X	
U2852-X	X	X	
U2853-X	X	X	
U2854-X	X	X	
U2855-X	X	X	
U2856-X	X	X	
U2862-X	X	X	
U2863-X	X	X	
U2864-X	X	X	
U2865-X	X	X	
U2866-X	X	X	
U5902-X-KK-BLG	X	X	
U5903-X-KK-BLG	X	X	
U5904-X-KK-BLG	X	X	
U5905-X-KK-BLG	X	X	
U5906-X-KK-BLG	X	X	
U5882-X-KK-BLG	X	X	
U5883-X-KK-BLG	X	X	
U5884-X-KK-BLG	X	X	
U5885-X-KK-BLG	X	X	
U5886-X-KK-BLG	X	X	
243210-CTC3R			X
363612-LC3R-SP-WB	X	X	
484812-CT3R-WB	X	X	
U5990-O	X	X	



Please consult serving utility for their requirements prior to ordering or installing, as specifications and approvals vary by utility, and may require local electrical inspector approval. All installations must be installed by a licensed electrician and must comply with all national and local codes, laws and regulations. Milbank reserves the right to make changes in specifications and features shown without notice or obligation.

850.....	43	U1129-O-K3L-K2L.....	11	U4375-XT-5T9.....	39
6002.....	43	U1232-RRL-KK-K1.....	20	U4376-XT-5T9.....	39
6003.....	43	U1233-RRL-KK-K1.....	20	U4408-O.....	34
6116.....	43	U1234-RXL-KK-K1.....	20	U4410-O.....	34
243210-CTC3R.....	34	U1252-RRL-KK-K1-BLG-SLVG.....	21	U4490-XL.....	31
304410-CTC3R.....	34	U1252-RRL-KK-K1-SLVG.....	21	U4492-XL.....	31
363612-LC3R-SP-WB.....	34	U1253-RRL-KK-K1-BLG-SLVG.....	21	U4493-XL.....	31
484812-CT3R-WB.....	34	U1253-RRL-KK-K1-SLVG.....	21	U4532-XL.....	9
5T8K2.....	44	U1254-RXL-KK-K1-BLG-SLVG.....	21	U4881-O-50GB.....	8
A7514.....	42	U1254-RXL-KK-K1-SLVG.....	21	U4881-O-60GB.....	8
A7515.....	42	U1255-RXL-KK-K1-BLG-SLVG.....	21	U4905-X.....	11
A7516.....	42	U1255-RXL-KK-K1-SLVG.....	21	U4905-X-BLG.....	11
A7517.....	42	U1256-RXL-KK-K1-BLG-SLVG.....	21	U4908-O-11GR.....	36
A7518.....	42	U1256-RXL-KK-K1-SLVG.....	21	U5000-XL.....	37
A7551.....	42	U1797-O-K3L-K2L.....	11	U5000-XL-41.....	37
A7551.....	42	U1797-O-K3L-K2L-BLG.....	11	U5000-XL-55.....	37
A8110.....	42	U1980-O-KK.....	9	U5000-XL-75.....	37
A8111.....	42	U1980-O-KK-BLG.....	9	U5059-X-2/200-K3L.....	17
A8112.....	42	U2120-X-K7.....	12	U5059-X-K3L.....	17
A9064.....	42	U2594-X.....	12	U5100-XL.....	37
A-GP.....	43	U2594-X-BLG.....	12	U5100-XL-41.....	37
BL7474.....	44	U2594-X-K7-K6-BLG.....	12	U5100-XL-55.....	37
CP-21.....	43	U2732-XT.....	24	U5100-XL-75.....	37
K1047.....	43	U2733-XT.....	24	U5101-XL-11GR.....	36
K1190.....	44	U2734-XT.....	24	U5136-O.....	35
K1350.....	43	U2735-XT.....	24	U5136-O-100S.....	35
K1350L.....	43	U2736-XT.....	24	U5136-O-200S.....	35
K1539.....	43	U2852-X.....	25	U5137-O-200S.....	35
K1540.....	43	U2853-X.....	25	U5161-X-K3L-K2L-BLG.....	11
K1540L.....	43	U2854-X.....	25	U5168-XTL-100-KK.....	16
K1541.....	43	U2855-X.....	25	U5168-XTL-100-KK-BLG.....	16
K3082.....	43	U2856-X.....	25	U5168-XTL-150-KK.....	16
K3083.....	43	U2862-X.....	25	U5168-XTL-150-KK-BLG.....	16
K3356.....	44	U2863-X.....	25	U5168-XTL-200-KK.....	16
K3441.....	43	U2864-X.....	25	U5168-XTL-200-KK-BLG.....	16
K3442.....	43	U2865-X.....	25	U5200-XL.....	38
K3865.....	44	U2866-X.....	25	U5200-XL-41.....	38
K4527.....	44	U2872-XT.....	23	U5200-XL-55.....	38
K4528.....	44	U2873-XT.....	23	U5200-XL-75.....	38
K4977-EXT.....	44	U2874-XT.....	23	U5268-XTL-150-KK.....	16
K4977-INT.....	44	U2875-XT.....	23	U5268-XTL-200-KK.....	16
K5022-INT.....	44	U2876-XT.....	23	U5268-XTL-200-KK-BLG.....	16
K5T.....	44	U3278-RL.....	10	U5300-O.....	38
M5-144.....	43	U3802.....	6	U5300-O-41.....	38
-R.....	42	U3812.....	6	U5300-O-55.....	38
-RL.....	42	U3822-20GWR.....	7	U5300-O-75.....	38
S4019-O.....	34	U3832.....	6	U5750-RXL-200-BL.....	15
S4020-O.....	34	U3862.....	6	U5764-X-200-CB.....	19
S4399-O.....	34	U3989-XL.....	14	U5765-X-200-CB.....	19
S4400-O.....	34	U4363-X-QG-K3-K2.....	11	U5767-X-200-CB.....	19
S8324.....	42	U4372-XT-5T9.....	39	U5784-O-200-CB.....	19
S8324.....	42	U4373-XT-5T9.....	39	U5787-O-200-CB.....	19
U1079-RRL-K3.....	11	U4374-XT-5T9.....	39	U5796-X-400-CB.....	19

Please consult serving utility for their requirements prior to ordering or installing, as specifications and approvals vary by utility, and may require local electrical inspector approval. All installations must be installed by a licensed electrician and must comply with all national and local codes, laws and regulations. Milbank reserves the right to make changes in specifications and features shown without notice or obligation.



U5797-O-400-CB.....	19	UC7636-RL.....	30
U5799-O-400-CB.....	19	UQFB-100.....	40
U5844-PXL-200-KK.....	14	UQFB-100-X1.....	40
U5844-PXL-200-KK-BLG.....	14	UQFB-125.....	40
U5871-XL-200.....	15	UQFB-125-X1.....	40
U5882-X-KK-BLG.....	27	UQFB-150.....	40
U5883-X-KK-BLG.....	27	UQFB-150-X1.....	40
U5884-X-KK-BLG.....	27	UQFB-175.....	40
U5885-X-KK-BLG.....	27	UQFB-175-X1.....	40
U5886-X-KK-BLG.....	27	UQFB-200.....	40
U5890-X-2/200-BL.....	17	UQFB-200-X1.....	40
U5890-X-2/200-BLG.....	17	UQFBH-100.....	40
U5891-X-2/200-MLK-BL.....	17	UQFBH-125.....	40
U5902-X-KK-BLG.....	27	UQFBH-150.....	40
U5903-X-KK-BLG.....	27	UQFBH-175.....	40
U5904-X-KK-BLG.....	27	UQFBH-200.....	40
U5905-X-KK-BLG.....	27	UQFBH-M-100.....	40
U5906-X-KK-BLG.....	27	UQFBH-M-125.....	40
U5971-XL-100.....	13	UQFBH-M-150.....	40
U5971-XL-150.....	13	UQFBH-M-175.....	40
U5971-XL-200.....	13	UQFBH-M-200.....	40
U5990-O.....	34	UQFP-100.....	40
U6115-X-2/200-K7L.....	17	UQFP-125.....	40
U6220-O-100-KK-10GR.....	35	UQFP-150.....	40
U6220-O-200-KK-10GR.....	35	UQFP-175.....	40
U6227-x-400-k3.....	18	UQFP-200.....	40
U6228-x-400-K3.....	18	UQFPH-100.....	40
U6229-X-400-K7.....	18	UQFPH-125.....	40
U6230-X-400-K7.....	18	UQFPH-150.....	40
U7021-RL-TG-KK.....	9	UQFPH-175.....	40
U7021-RL-TG-KK-BLG.....	9	UQFPH-200.....	40
U7040-RL-TG-KK.....	9	UQFPH-M-100.....	40
U7040-RL-TG-KK-BLG.....	9	UQFPH-M-125.....	40
U7040-XL-TG-KK.....	9	UQFPH-M-150.....	40
U7487-RL-TG-KK.....	9	UQFPH-M-175.....	40
U7487-RL-TG-KK-BLG.....	9	UQFPH-M-200.....	40
U9551-RRL.....	10	UQFP-M-100.....	40
U9701-RRL.....	10	UQFP-M-125.....	40
U9701-RRL-BLG.....	10	UQFP-M-150.....	40
UC1299-RL.....	29	UQFP-M-175.....	40
UC1300-RL.....	29	UQFP-M-200.....	40
UC7235-RL.....	29	USE-22-200-MB.....	13
UC7237-XL.....	29	Z802965-AC.....	44
UC7444-RL.....	30	Z814898-AC.....	44
UC7445-RL.....	30	Z901925-AC.....	44
UC7445-RL-641.....	30	Z904486-AO.....	44
UC7445-WL.....	30	Z916264-AO.....	44
UC7448-RL.....	30	Z916265-AO.....	44
UC7449-RL.....	30		
UC7460-RL.....	30		
UC7461-RL.....	30		
UC7478-RL.....	30		
UC7532-RL.....	30		



Please consult serving utility for their requirements prior to ordering or installing, as specifications and approvals vary by utility, and may require local electrical inspector approval. All installations must be installed by a licensed electrician and must comply with all national and local codes, laws and regulations. Milbank reserves the right to make changes in specifications and features shown without notice or obligation.









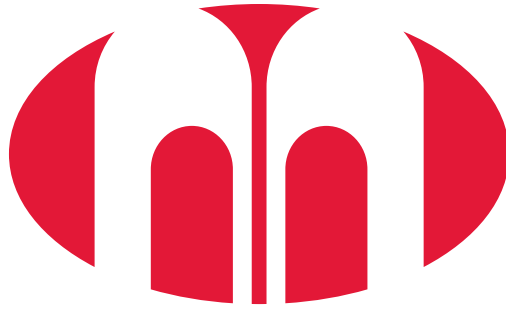

# MILBANK<sup>®</sup>

ENERGY AT WORK

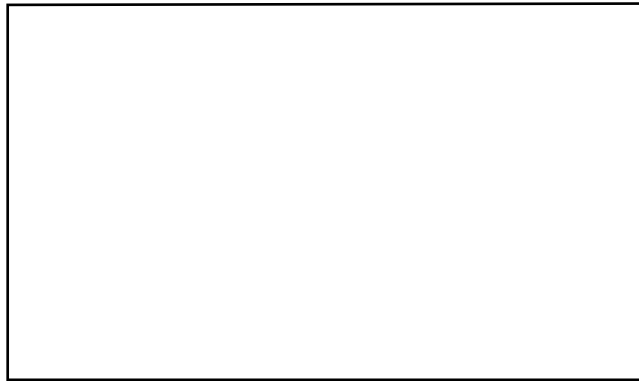

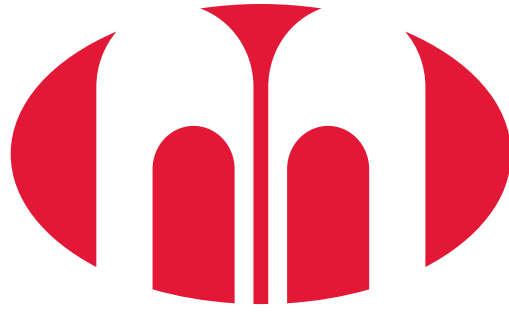

**MILBANK**<sup>®</sup>  
ENERGY AT WORK



# Ohio

*Meter Mounting Equipment*



# Milbank Overview

## Energy At Work since 1927

Milbank designs and manufactures electrical solutions that move and manage power for the residential, commercial, industrial, utility and transportation sectors. With 90 years of expertise in electrical engineering design and manufacturing, Milbank's portfolio includes metering equipment, enclosures and enclosed controls. Founded in 1927, Milbank is a family-owned, American manufacturer headquartered in Kansas City, Mo. For more information, please visit [milbankworks.com](http://milbankworks.com).

### METERING



As a market leader in electrical metering equipment, Milbank has set the standard for quality since 1927. Hundreds of configurations are available, including many sizes, knockout configurations, terminal configurations, bypass options, hubs, locks and connectors. Milbank has the socket you need with thousands of active products to meet your utility's requirements.

### ENCLOSURES



Milbank's line of enclosures include commercial junction boxes, panel mount enclosures, transformer cabinets, wireway, trough and industrial panel mount and push-button enclosures. Built with high-quality craftsmanship and materials which meet or exceed industry standards, Milbank enclosures are made to protect controls and equipment from dust, dirt and other harmful elements found in a wide variety of environments.

### ENCLOSED CONTROLS



Milbank doesn't just build empty enclosures. We can deliver the entire package, complete with custom control equipment built to your exact specifications by our engineers. Milbank commercial pedestals are an attractive, secure, easy to install and cost-effective solution when underground remote site power distribution and control equipment is required, replacing unsightly and inefficient strut and backboard structures.



Please consult serving utility for their requirements prior to ordering or installing, as specifications and approvals vary by utility, and may require local electrical inspector approval. All installations must be installed by a licensed electrician and must comply with all national and local codes, laws and regulations. Milbank reserves the right to make changes in specifications and features shown without notice or obligation.

# Table of Contents

## Air Conditioner Disconnects

30-60 amp AC disconnects .....	6
60 amp AC disconnect with 20 amp GFCI receptacle .....	7
Hot tub disconnects .....	8

## Single Position Sockets

125-200 amps, 4 terminal, ringless .....	9
200 amps, 4, 5 & 7 terminals, lever bypass, ringless .....	10
320 amps, 4 terminal, lever bypass, ringless .....	11
320 amps, 7 terminal, lever, ringless .....	12

## Unmetered Load Centers

100-200 amps .....	13
--------------------	----

## Meter Mains

100-200 amps, 4 terminals, with load center, ringless .....	14
200 amps, 4 & 7 terminals, lever bypass, ringless .....	15

## Meter Main with Load Center

100-200 amps, 4 terminals, with load center, ringless .....	16
---	----

## Meter Mains with Lever Bypass

320 amps, 4 & 7 terminals, lever bypass, ringless .....	17-18
---	-------

## Cold Sequence Meter Mains

200 & 400 amps, 4, 5 & 7 terminals, ringless .....	19
--	----

## Multi-Position Sockets

150 amps, 4 terminals, ringless .....	20
200 amps, 4 terminals, ringless .....	21-22
200 amps, 5 terminals, lever bypass, ringless .....	23
200 amps, 7 terminals, lever bypass, ringless .....	24

## Multi-Position Meter Mains

125 & 200 amps, 4 terminals, ringless .....	25-28
---	-------

Please consult serving utility for their requirements prior to ordering or installing, as specifications and approvals vary by utility, and may require local electrical inspector approval. All installations must be installed by a licensed electrician and must comply with all national and local codes, laws and regulations. Milbank reserves the right to make changes in specifications and features shown without notice or obligation.



**Transformer Rated**

20 amps, plunger bypass, ringless & ring type .....	29
20 amps, test switch provision .....	30
80 amps, 6, 8 & 13 terminals, lever bypass .....	31
Test Switches .....	32
Test Switch Worksheet .....	33
Current Transformer Cabinets .....	34

**Pedestals**

100-200 amp, 4 terminal, meter main with load center, ringless.....	35
---	----

**Temporary Power Units**

125 amp, 4 terminal, ringless .....	36
-------------------------------------	----

**Surface & Pedestal Mount Power Outlets**

125 amp, 4 terminal, surface mount .....	37
125 amp, 4 terminal, pedestal mount .....	38

**Miscellaneous**

Terminal Boxes .....	39
Circuit Breaker .....	40-41
Accessories .....	42-45
Commercial Pedestals.....	46-55
Industrial and Commercial Enclosures.....	56
Reference Information .....	57-62
Index.....	63-64



Please consult serving utility for their requirements prior to ordering or installing, as specifications and approvals vary by utility, and may require local electrical inspector approval. All installations must be installed by a licensed electrician and must comply with all national and local codes, laws and regulations. Milbank reserves the right to make changes in specifications and features shown without notice or obligation.



# Catalog Number Logic

How our product catalog numbers are derived

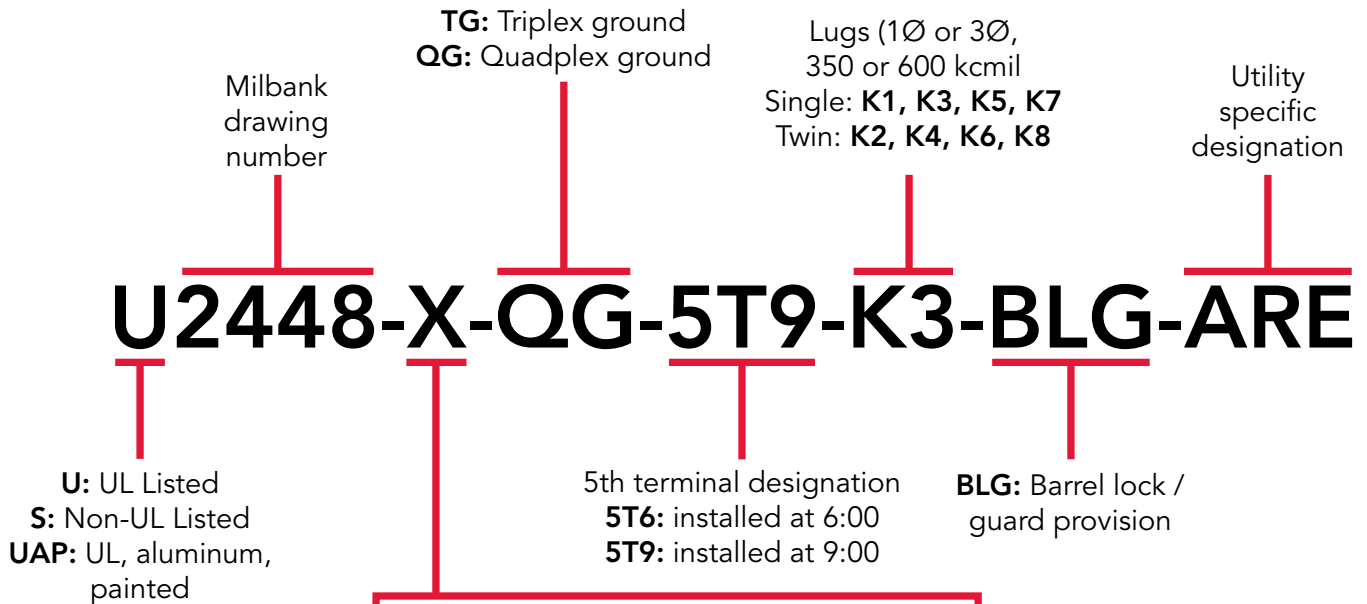

### Hub Openings & Closing Plates

<b>-O</b> Blank top	<b>-PXL</b> Closing plate packed inside
<b>-RL</b> Small hub opening	<b>-WL</b> 1" hub
<b>-R</b> Large hub opening	<b>-YL</b> 1¼" hub
<b>-XL</b> Small closing plate	<b>-ZL</b> 1½" hub
<b>-XT</b> (2) Large Closing plates	<b>-DL</b> 2" hub
<b>-XTL</b> (2) Small closing plates	<b>-EL</b> 2½" hub
<b>-X</b> Large closing plate	<b>-F</b> 3" hub
<b>-RXL</b> Large hub opening adapted to small closing plate	<b>-G</b> 3½" hub
<b>-RRL</b> Large hub opening adapted to small hub opening	<b>-H</b> 4" hub

**U:** UL Listed  
**S:** Non-UL Listed  
**UAP:** UL, aluminum, painted

**KK:** Horn bypass

**BL:** Barrel lock

## U7040-RL-TG-KK-5T9-BL-AUT

Milbank drawing number

**TG:** Triplex ground  
**QG:** Quadplex ground

5th terminal designation  
**5T6:** installed at 6:00  
**5T9:** installed at 9:00

Utility specific designation

Please consult serving utility for their requirements prior to ordering or installing, as specifications and approvals vary by utility, and may require local electrical inspector approval. All installations must be installed by a licensed electrician and must comply with all national and local codes, laws and regulations. Milbank reserves the right to make changes in specifications and features shown without notice or obligation.



# Air Conditioner Disconnects

30-60 Amps | Fusible & Non-Fusible



**U3802**



**U3812**



**U3832**

Milbank's air conditioner disconnect has a removable hinged cover for ease of installation. Our compact design meets NEC wiring space requirements and also complies with NEC article 440-14. For safe working conditions, our disconnect pullers may be removed and reinstalled in the OFF position. Additionally, padlock provisions are included on the front cover. As with other Milbank products, our enclosure is constructed of G90U galvanized steel and electrostatically finished with an attractive, light gray, baked powder coating. Our epoxy/polyester resin blend offers a finish that is both durable and fade-resistant.

## 30-60 Amps | 1Ø 240 VAC | Air Conditioner Disconnects

Catalog Number	Amps	Type	Max H.P.	Weight (lbs.)	Line/Load Wire Range		Ground Wire Range CU/AL	Dimensions			Wire Rating	
					CU	AL		D"	W"	H"	CU °C	AL °C
<b>U3802</b>	60	Non-Fusible	10	3.25	#14-#2	#12-#2	#14-4	2½	5	7½	60°/75°	60°/75°
<b>U3812</b>	60	Non-Auto	10	3.25	#14-#2	#12-#2	#14-4	2½	5	7½	60°/75°	60°/75°
<b>U3832</b>	30	Fusible	3	2.5	#14-#3	#14-#3	#14-3	2½	5	7	60°/75°	60°/75°
<b>U3862</b>	60	Fusible	10	3.3	#14-#3	#14-#3	#14-3	2½	5	9	60°/75°	60°/75°

### Notes

- UL listed as Enclosed Pullout Switch
- Type 3R rain-resistant
- One-inch concentric knockouts



Please consult serving utility for their requirements prior to ordering or installing, as specifications and approvals vary by utility, and may require local electrical inspector approval. All installations must be installed by a licensed electrician and must comply with all national and local codes, laws and regulations. Milbank reserves the right to make changes in specifications and features shown without notice or obligation.

# Air Conditioner Disconnects

## 20 Amp GFCI Receptacle



U3822-20GWR

### Specifications

- Meets NEC #210.63 requirements
- UL listed as Power Outlet
- Type 3R enclosure
- In-use cover\*
- Duplex ground connector
- 1" concentric knockouts
- 1Ø, 240 volt
- 60 amp, non-fused
- 20 amp GFCI receptacle
- Reset/test button
- Weather and tamper resistant
- Meets NEC #406.8 requirements

### 60 Amps | 1Ø, 240 VAC | Air Conditioner Disconnect with GFCI Receptacle

Catalog Number	Type	Max H.P.	Weight (lbs.)	Line/Load Wire Range		Ground Wire Range CU/AL	Dimensions			Wire Rating	
				CU	AL		D"	W"	H"	CU °C	AL °C
U3822-20GWR	Non-Fusible	10	6	#14-#2	#12-#2	#14-4	4 $\frac{1}{8}$ "	5 $\frac{1}{4}$ "	7 $\frac{1}{2}$ "	60°/75°	60°/75°

### Notes

- **Disconnect Pullers:** To ensure the safest conditions, Milbank disconnect pullers are reversible so they may be reinstalled in the OFF position.
- **Padlock Provision:** All units are designed with a padlock provision on the cover for security.
- **\*In-Use Cover:** Cover is rated as an in-use cover (cover may be closed with cords plugged into receptacle).

Please consult serving utility for their requirements prior to ordering or installing, as specifications and approvals vary by utility, and may require local electrical inspector approval. All installations must be installed by a licensed electrician and must comply with all national and local codes, laws and regulations. Milbank reserves the right to make changes in specifications and features shown without notice or obligation.



# Hot Tub Disconnects

## Type 3R Enclosures



**U4881-O-50GB**



**U4881-O-60GB**

### Specifications

- 240 volt ground fault protection
- UL listed, Type 3R rain-resistant
- 2-pole, 50 or 60 amp GFCI breaker protection
- Compact size
- Three or four wire installation
- 1Ø, 120/240 VAC
- Standard package of 12
- Two extra one-pole breaker spaces
- 100 amp overall rating
- Easy to install

### 100 Amps | Hot Tub Disconnect or Sub Panel Breaker Enclosure | Type 3R

Catalog Number	Breaker Amps	Type	Weight (lbs.)	Line/Load Wire Range		Ground Wire Range CU/AL	Dimensions		
				CU	AL		D"	W"	H"
U4881-O-50GB	50	Breaker	8	#14-1/0	#14-1/0	#14-1/0	3¾	7½	8½
U4881-O-60GB	60	Breaker	8	#14-1/0	#14-1/0	#14-1/0	3¾	7½	8½



Please consult serving utility for their requirements prior to ordering or installing, as specifications and approvals vary by utility, and may require local electrical inspector approval. All installations must be installed by a licensed electrician and must comply with all national and local codes, laws and regulations. Milbank reserves the right to make changes in specifications and features shown without notice or obligation.

# Single Position Sockets

4 Terminal | 125-200 Amp | Ringless | 600 VAC

9

125-200 AMP  
SINGLE  
POSITION



U7487-RL-TG-KK

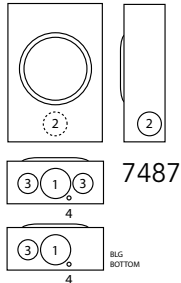

U7040-RL-TG-KK

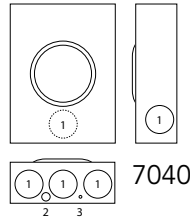

U4532-XL

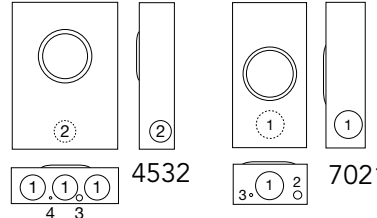

U1980-O-KK

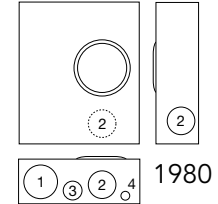

4 Terminal | Single Position | Ringless | 1Ø3W

Catalog Number	Amps	Service	Hub	Connectors CU/AL			Dimensions			Knockouts			
				Line	Load	Bypass	D"	W"	H"	1	2	3	4
U7487-RL-TG-KK	125	OH/UG	H.O.	#6-2/0	#6-2/0	Horn	3 <sup>5</sup> / <sub>16</sub>	8	11 <sup>1</sup> / <sub>2</sub>	2	1 <sup>1</sup> / <sub>2</sub>	1 <sup>1</sup> / <sub>4</sub>	1 <sup>1</sup> / <sub>4</sub>
U7487-RL-TG-KK-BLG	125	OH/UG	H.O.	#6-2/0	#6-2/0	Horn	3 <sup>5</sup> / <sub>16</sub>	8	11 <sup>1</sup> / <sub>2</sub>	2	—	1 <sup>1</sup> / <sub>4</sub>	1 <sup>1</sup> / <sub>4</sub>
U7021-RL-TG-KK	200	OH	H.O.	#6-350	#6-350	Horn	4 <sup>1</sup> / <sub>8</sub>	8	15 <sup>1</sup> / <sub>2</sub>	2 <sup>1</sup> / <sub>2</sub>	1 <sup>1</sup> / <sub>4</sub> , 1 <sup>1</sup> / <sub>2</sub>	1 <sup>1</sup> / <sub>4</sub>	—
U7021-RL-TG-KK-BLG	200	OH	H.O.	#6-350	#6-350	Horn	4 <sup>1</sup> / <sub>8</sub>	8	15 <sup>1</sup> / <sub>2</sub>	2 <sup>1</sup> / <sub>2</sub>	1 <sup>1</sup> / <sub>4</sub> , 1 <sup>1</sup> / <sub>2</sub>	1 <sup>1</sup> / <sub>4</sub>	—
U7040-RL-TG-KK	200	OH/UG	H.O.	#6-350	#6-350	Horn	4 <sup>1</sup> / <sub>8</sub>	11	14 <sup>5</sup> / <sub>8</sub>	2 <sup>1</sup> / <sub>2</sub>	1 <sup>1</sup> / <sub>4</sub> , 1 <sup>1</sup> / <sub>2</sub>	1 <sup>1</sup> / <sub>4</sub>	—
U7040-RL-TG-KK-BLG	200	OH/UG	H.O.	#6-350	#6-350	Horn	4 <sup>1</sup> / <sub>8</sub>	11	14 <sup>5</sup> / <sub>8</sub>	2 <sup>1</sup> / <sub>2</sub>	1 <sup>1</sup> / <sub>4</sub> , 1 <sup>1</sup> / <sub>2</sub>	1 <sup>1</sup> / <sub>4</sub>	—
U7040-XL-TG-KK	200	OH/UG	C.P.	#6-350	#6-350	Horn	4 <sup>1</sup> / <sub>8</sub>	11	14 <sup>5</sup> / <sub>8</sub>	2 <sup>1</sup> / <sub>2</sub>	1 <sup>1</sup> / <sub>4</sub> , 1 <sup>1</sup> / <sub>2</sub>	1 <sup>1</sup> / <sub>4</sub>	—
U4532-XL	200	OH/UG	C.P.	#6-350	(2) #6-350	None	4 <sup>1</sup> / <sub>8</sub>	15	20 <sup>1</sup> / <sub>2</sub>	3	2 <sup>1</sup> / <sub>2</sub>	1 <sup>1</sup> / <sub>4</sub> , 1 <sup>1</sup> / <sub>2</sub>	1 <sup>1</sup> / <sub>4</sub>

200 Amp | 4 Terminal | Single Position | Ringless | Side Wireway | 1Ø3W

Catalog Number	Service	Hub	Connectors CU/AL			Bypass	Dimensions			Knockouts			
			Line	Load	D"		W"	H"	1	2	3	4	
U1980-O-KK	UG	Blank	#6-350	#6-350	Horn	4 <sup>1</sup> / <sub>2</sub>	13	15 <sup>1</sup> / <sub>4</sub>	3	2 <sup>1</sup> / <sub>2</sub>	1 <sup>1</sup> / <sub>2</sub>	1 <sup>1</sup> / <sub>4</sub> , 1 <sup>1</sup> / <sub>2</sub>	
U1980-O-KK-BLG	UG	Blank	#6-350	#6-350	Horn	4 <sup>1</sup> / <sub>2</sub>	13	15 <sup>1</sup> / <sub>4</sub>	3 <sup>1</sup> / <sub>2</sub>	2 <sup>1</sup> / <sub>2</sub>	1 <sup>1</sup> / <sub>2</sub>	1 <sup>1</sup> / <sub>4</sub> , 1 <sup>1</sup> / <sub>2</sub>	

## Notes

- **Hubs:** Order hubs separately — see accessory page for ordering information.
- **Fifth Terminal:** For field mounted fifth terminal for **U7021**, **U7040**, **U4532** and **U1980**, order catalog number **K5T**. For the **U7487**, order catalog number **5T8K2**.
- **Connectors:** Extruded aluminum connectors are tin plated.
- **U4532:** Includes twin lug connector on load side.
- **Tap Connector:** For tap connector, order **K4977-INT**.
- **Product numbers with BLG are used in AEP service areas**

Please consult serving utility for their requirements prior to ordering or installing, as specifications and approvals vary by utility, and may require local electrical inspector approval. All installations must be installed by a licensed electrician and must comply with all national and local codes, laws and regulations. Milbank reserves the right to make changes in specifications and features shown without notice or obligation.



# Single Position Lever Bypass

4, 5 & 7 Terminal | 200 Amp | Ringless | 600 VAC



**U3278-RL**



**U9551-RRL**



**U9701-RRL**

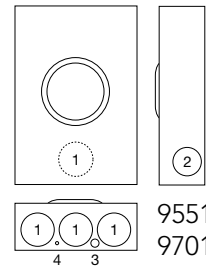
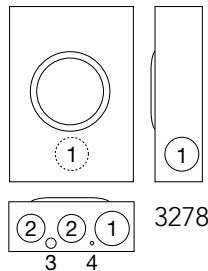

**200 Amp | Single Position | Lever Bypass | Ringless | Non-Jaw Clamping**

Catalog Number	Terminal	Phase	Service	Hub	Connectors CU/AL	Dimensions			Knockouts			
						D"	W"	H"	1	2	3	4
U3278-RL	4	1Ø3W	OH	H.O.	#6-350	4 <sup>7</sup> / <sub>8</sub>	11	15 <sup>1</sup> / <sub>2</sub>	2 <sup>1</sup> / <sub>2</sub>	2	1 <sup>1</sup> / <sub>4</sub> , 1 <sup>1</sup> / <sub>2</sub>	1 <sup>1</sup> / <sub>4</sub>

**200 Amp | Single Position | Heavy Duty Lever Bypass | Ringless | Jaw Clamping**

Catalog Number	Terminal	Phase	Service	Hub	Connectors CU/AL	Dimensions			Knockouts			
						D"	W"	H"	1	2	3	4
U9551-RRL	5	1Ø3W or 3Ø3W	OH/UG	H.O.	#6-350	4 <sup>7</sup> / <sub>8</sub>	13	19	3	2 <sup>1</sup> / <sub>2</sub>	1 <sup>1</sup> / <sub>4</sub> , 1 <sup>1</sup> / <sub>2</sub>	1 <sup>1</sup> / <sub>4</sub>
U9701-RRL	7	3Ø4W	OH/UG	H.O.	#6-350	4 <sup>7</sup> / <sub>8</sub>	13	19	3	2 <sup>1</sup> / <sub>2</sub>	1 <sup>1</sup> / <sub>4</sub> , 1 <sup>1</sup> / <sub>2</sub>	1 <sup>1</sup> / <sub>4</sub>
U9701-RRL-BLG	7	3Ø4W	OH/UG	H.O.	#6-350	4 <sup>7</sup> / <sub>8</sub>	13	19	3	2 <sup>1</sup> / <sub>2</sub>	1 <sup>1</sup> / <sub>4</sub> , 1 <sup>1</sup> / <sub>2</sub>	1 <sup>1</sup> / <sub>4</sub>

**Notes**

- **Hubs:** For proper hub selection, see the hub suffix chart on the accessory page.
- **Connectors:** Extruded aluminum connectors are tin plated.
- **Bypass:** The lever on the **U3278** unit operates the bypass device only; it does not provide clamping action on the meter spades. The levers on the **U9551** and **U9701** units supply clamping action on meter spades and also operate the bypass devices.
- **Product numbers with BLG are used in AEP service areas**



Please consult serving utility for their requirements prior to ordering or installing, as specifications and approvals vary by utility, and may require local electrical inspector approval. All installations must be installed by a licensed electrician and must comply with all national and local codes, laws and regulations. Milbank reserves the right to make changes in specifications and features shown without notice or obligation.

# Single Position Lever Bypass

320 Amp | 4 Terminal | Ringless | 600 VAC

**1 1**  
320 AMP  
SINGLE  
POSITION  
LEVER BYPASS



U4363-X-QG-K3-K2

U1079-RRL-K3

U1129-O-K3L-K2L

U1797-O-K3L-K2L

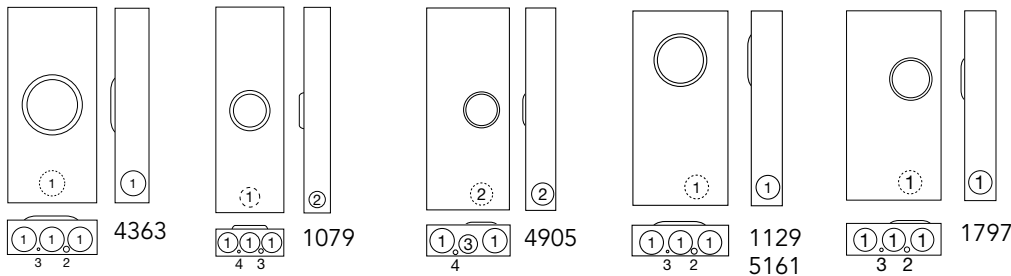

320 Amp Continuous (400 Amp Max) | 4 Terminal | Single Position | Ringless | 1Ø3W

Catalog Number	Service	Hub	Connectors CU/AL		Bypass	Dimensions			Knockouts			
			Line	Load		D"	W"	H"	1	2	3	4
U4363-X-QG-K3-K2	OH	C.P.	(1) #4-600 or (2) 1/0-250	(2)#6-350	Lever	4 <sup>7</sup> / <sub>8</sub>	13	28 <sup>1</sup> / <sub>4</sub>	3	1/4, 1/2	1/4	—
U1079-RRL-K3	OH	H.O.	(1) #4-600 or (2) 1/0-250	3/8" x 16 Studs	Lever	4 <sup>7</sup> / <sub>8</sub>	13	38 <sup>3</sup> / <sub>4</sub>	3	2 <sup>1</sup> / <sub>2</sub>	1/4, 1/2	1/4
U4905-X	OH/UG	C.P.	3/8" x 16 Studs	3/8" x 16 Studs	Lever	5 <sup>3</sup> / <sub>4</sub>	16	38 <sup>3</sup> / <sub>4</sub>	4	3 <sup>1</sup> / <sub>2</sub>	3	1/4, 1/2
U4905-X-BLG	OH/UG	C.P.	3/8" x 16 Studs	3/8" x 16 Studs	Lever	5 <sup>3</sup> / <sub>4</sub>	16	38 <sup>3</sup> / <sub>4</sub>	4	3 <sup>1</sup> / <sub>2</sub>	3	1/4, 1/2
U1129-O-K3L-K2L	UG	Blank	(1) #4-600 or (2) 1/0-250	(2) #6-350	Lever	4 <sup>7</sup> / <sub>8</sub>	15	30	3	1/4, 1/2	1/4	—
U5161-X-K3L-K2L-BLG	OH/UG	C.P.	(1) #4-600 or (2) 1/0-250	(2) #6-350	Lever	4 <sup>7</sup> / <sub>8</sub>	15	30	3	1/2	1/4	—
U1797-O-K3L-K2L	UG	Blank	(1) #4-600 or (2) 1/0-250	(2) #6-350	Lever	4 <sup>7</sup> / <sub>8</sub>	15	30	3	1/4, 1/2	1/4	—
U1797-O-K3L-K2L-BLG	UG	Blank	(1) #4-600 or (2) 1/0-250	(2) #6-350	Lever	4 <sup>7</sup> / <sub>8</sub>	15	30	3	1/4, 1/2	1/4	—

## Notes

- **Side Wireway:** U1797 and U4905 are side wireway units.
- **Bypass:** Lever supplies clamping action and also operates bypass device.
- **Hubs:** For proper hub selection, see the hub suffix chart on the accessory page.
- **Connectors:** Supplied with 3/8" x 16 hex head nuts with Belleville washers. For connector kits, order as extra **K1540** (single 600 kcmil). For twin lug connectors, order as extra **K1350** (twin 350 kcmil). Order two kits to cover both line and load on **U4905** and one kit for load side of **U1079**.
- **Fifth Terminal:** For factory-installed fifth terminal in the 6 o'clock position, add the suffix **-5T6** to the catalog number. For factory-installed fifth terminal in the 9 o'clock position, add the suffix **-5T9** to the catalog number. For field-installed fifth terminal, order as extra catalog number **K3865** for **U1129**, **U1797** and **U4905** and **K3866** for **U1079**.
- **Product numbers with BLG are used in AEP service areas**

Please consult serving utility for their requirements prior to ordering or installing, as specifications and approvals vary by utility, and may require local electrical inspector approval. All installations must be installed by a licensed electrician and must comply with all national and local codes, laws and regulations. Milbank reserves the right to make changes in specifications and features shown without notice or obligation.



# Single Position Lever Bypass

320 Amp | 7 Terminal | Ringless | 600 VAC



U2120-X-K7

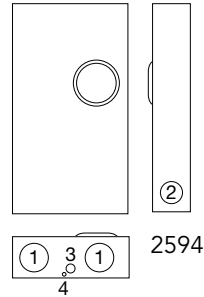
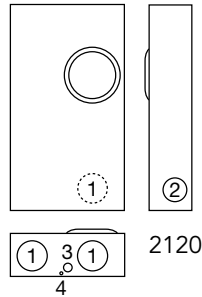

U2594-X

320 Amp | 7 Terminal | Single Position | Ringless | Side Wireway | 3Ø4W

Catalog Number	Service	Hub	Connectors CU/AL		Bypass	Dimensions			Knockouts			
			Line	Load		D"	W"	H"	1	2	3	4
U2594-X	OH/UG	C.P.	3/8" x 16 Studs	3/8" x 16 Studs	Lever	6 1/2	19	34 1/8	4	3	1	1/4
U2594-X-K7-K6-BLG	OH/UG	C.P.	3/8" x 16 Studs	3/8" x 16 Studs	Lever	6 1/2	19	34 1/8	4	3	1	1/4
U2594-X-BLG	OH/UG	C.P.	3/8" x 16 Studs	3/8" x 16 Studs	Lever	6 1/2	19	34 1/8	4	3	1	1/4
U2120-X-K7	UG	C.P.	(1) #4-600 or (2) 1/0-250	3/8" x 16 Studs	Lever	6 1/2	17 3/4	31 3/4	4	3	1	1/4

## Notes

- **Hubs:** For proper hub selection, see the hub suffix chart on the accessory page.
- **Bypass:** Lever supplies clamping action and also operates bypass device.
- **Connectors:** Supplied with 3/8" x 16 hex head nuts with Belleville washers. For connector kits, order as extra **K3441** (single 600 kcmil). For twin lug connectors, order as extra **K3442** (twin 350 kcmil). Separate kits are required for both line and load. Line side connectors furnished on **U2120**.
- **Product numbers with BLG are used in AEP service areas.**



Please consult serving utility for their requirements prior to ordering or installing, as specifications and approvals vary by utility, and may require local electrical inspector approval. All installations must be installed by a licensed electrician and must comply with all national and local codes, laws and regulations. Milbank reserves the right to make changes in specifications and features shown without notice or obligation.



# Unmetered Load Centers

200 Amp | 120/240 VAC

**13**  
200 AMP  
UNMETERED  
LOAD CENTERS



USE-22-200-MB

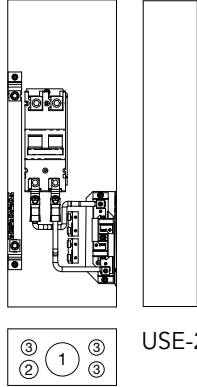

USE-22



U5971-XL-200

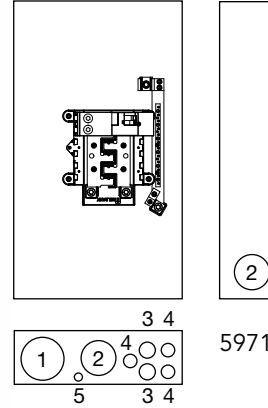

U5971

## 200 Amp | Unmetered Load Center with Main Breaker

Catalog Number	Main Breaker Amp	Circuits	Service	Hub	Dimensions			Knockouts				
					D"	W"	H"	1	2	3	4	5
USE-22-200-MB	200	4	OH	2"	4	8	23	2	1	1/2, 3/4	—	—
U5971-XL-100	100	10	OH/UG	C.P.	4 1/2	14 1/8	25 1/6	3	2	1	1/2, 3/4	1/4, 1/2
U5971-XL-150	150	8	OH/UG	C.P.	4 1/2	14 1/8	25 1/6	3	2	1	1/2, 3/4	1/4, 1/2
U5971-XL-200	200	8	OH/UG	C.P.	4 1/2	14 1/8	25 1/6	3	2	1	1/2, 3/4	1/4, 1/2

## Notes

- **AIC Rating:** This units are rated 22K AIC.
- **Breaker Interlock:** U5971 accepts breaker interlock kits — order **K5815** for large QN with small frame Q, **K5820** for large frame QN with large frame QN, or **K5830** for small frame Q to small frame Q.

Please consult serving utility for their requirements prior to ordering or installing, as specifications and approvals vary by utility, and may require local electrical inspector approval. All installations must be installed by a licensed electrician and must comply with all national and local codes, laws and regulations. Milbank reserves the right to make changes in specifications and features shown without notice or obligation.





U3989-XL

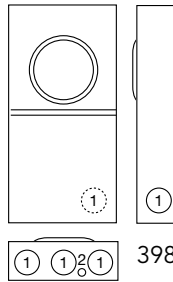

3989



U3491-XL-200

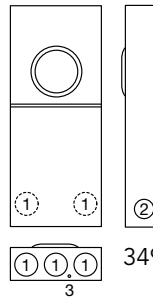

3491



U5844-PXL-200-KK

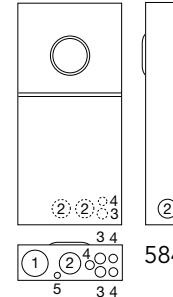

5844

4 Terminal | Meter Mains | Ringless | 1Ø3W

Catalog Number	Service	Amp	Hub	Connectors CU/AL		Bypass	Dimensions			Knockouts				
				Line	Load		D"	W"	H"	1	2	3	4	5
U3989-XL	OH/UG	125	C.P.	#6-2/0	CB	None	3¾	11	22	2	¼, ½	—	—	—
U5844-PXL-200-KK	OH/UG	200	C.P.	#6-350	CB	Horn	4½	14	30	3	2½	1	½, ¾	¼, ½
U5844-PXL-200-KK-BLG	OH/UG	200	C.P.	#6-350	CB	Horn	4½	14	30	3	2½	1	½, ¾	¼, ½

### Notes

- **Hubs:** For proper hub selection, see the hub suffix chart on the accessory page.
- **Breaker:** For replacement breakers for **U3491**, order **UQFB-200-X1**; for **U5844** order **QN2200H**. For **U3989**, order approved small frame breakers 125 amps or less per the rating label.
- **Fifth Terminal:** For field installable fifth terminal kit, order **K5T**.
- **AIC Rating:** The **U5844** is 22K AIC rated.
- **PXL** - Closing plate packed inside of carton.
- **Product numbers with BLG are used in AEP service areas.**



Please consult serving utility for their requirements prior to ordering or installing, as specifications and approvals vary by utility, and may require local electrical inspector approval. All installations must be installed by a licensed electrician and must comply with all national and local codes, laws and regulations. Milbank reserves the right to make changes in specifications and features shown without notice or obligation.

# Meter Mains

200 Amp | 4 & 7 Terminal | Lever Bypass | Ringless

**15**  
200 AMP  
LEVER BYPASS  
METER MAINS

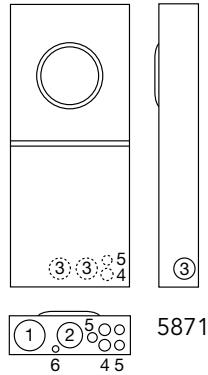

U5871-XL-200

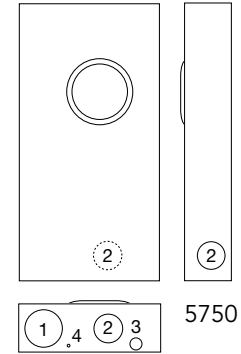

U5750-RXL-200-BL

## 200 Amp | Meter Main | Lever Bypass | Ringless

Catalog Number	Terminals	Breaker Amps	Service	Hub	Connectors CU/AL - Line	Dimensions			Knockouts					
						D"	W"	H"	1	2	3	4	5	6
U5871-XL-200	4	200	OH/UG	C.P.	#6-350	4½	14⅞	32	3	2½	2	1	½,¾	¼,½
U5750-RXL-200-BL	7	200	OH/UG	C.P.	#6-350	5¾	17¾	34	4	3	1	¼	—	—

### Notes

- **Breakers:** U5871 is rated 22K AIC with QNR2200H main installed. U5750 is rated 10K AIC with UQFB-3200 main installed.
- **-BL:** Barrel lock
- **Fifth Terminal:** For field installed fifth terminal for U5871, order K5T.
- **Interlock Kit:** For generator auxiliary circuit breaker interlock for U5871, order K5815 for large QN with small frame Q; order K5820 for large frame QN with large frame QN.

Please consult serving utility for their requirements prior to ordering or installing, as specifications and approvals vary by utility, and may require local electrical inspector approval. All installations must be installed by a licensed electrician and must comply with all national and local codes, laws and regulations. Milbank reserves the right to make changes in specifications and features shown without notice or obligation.



# 16

200 AMP  
METER MAIN  
WITH LOAD  
CENTER

# Meter Main With Load Center

200 Amp | 4 Terminal | Ringless | 120/240 VAC



U5168-XTL-200-KK

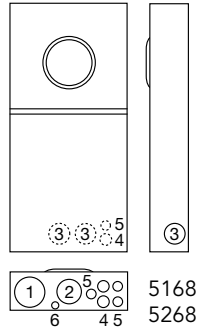

U5268-XTL-200-KK

Knockouts					
1	2	3	4	5	6
3	2½	2	1	½, ¾	¼, ½

200 Amp | 4 Terminal | Meter Mains | Horn Bypass | Ringless | 1Ø3W

Catalog Number	Breaker Amps	Circuits	Service	Hub	Connectors CU/AL - Line	Dimensions		
						D"	W"	H"
U5168-XTL-100-KK	100	10	OH/UG	C.P.	#6-350	4½	14⅞	32
U5168-XTL-100-KK-BLG	100	10	OH/UG	C.P.	#6-350	4½	14⅞	32
U5168-XTL-150-KK	150	8	OH/UG	C.P.	#6-350	4½	14⅞	32
U5168-XTL-150-KK-BLG	150	8	OH/UG	C.P.	#6-350	4½	14⅞	32
U5168-XTL-200-KK	200	8	OH/UG	C.P.	#6-350	4½	14⅞	32
U5168-XTL-200-KK-BLG	200	8	OH/UG	C.P.	#6-350	4½	14⅞	32
U5268-XTL-150-KK	150	20	OH/UG	C.P.	#6-350	4½	14⅞	32
U5268-XTL-200-KK	200	20	OH/UG	C.P.	#6-350	4½	14⅞	32
U5268-XTL-200-KK-BLG	200	20	OH/UG	C.P.	#6-350	4½	14⅞	32

## Notes

- **Fifth Terminal:** For field installed fifth terminal, order **K5T**.
- **Breakers:** Rated 22K AIC with **QN2200H** main installed for **U5168** and **U5268**.
- **Sub Feed Lugs:** #6-350 sub feed lugs provided on 8 circuit interior. **Not available on 20 circuit interior.**
- **Main Lug Kit:** Main lug feed-through kit **K3701** available.
- **XTL -** Two small hub closing plate.
- **Product numbers with BLG are used in AEP service areas**

**Generator Interlock — for use with U5168 and U5268**

	K5815	K5820	K5830
	Large QN with small frame Q	Large frame QN with large frame QN	Small frame Q to small frame Q

## Branch Breaker Chart

AIC Rating	Amps	Siemens	Cutler Hammer	General Electric	Square D
10k	150-200	QNR	BR (150A only)	—	—
	≤ 125	QP	HQP, BR	THQL, THQL-GF	Homeline
22k	150-200	QNRH	—	—	—
	≤ 125	QPH	—	—	—



Please consult serving utility for their requirements prior to ordering or installing, as specifications and approvals vary by utility, and may require local electrical inspector approval. All installations must be installed by a licensed electrician and must comply with all national and local codes, laws and regulations. Milbank reserves the right to make changes in specifications and features shown without notice or obligation.

# Lever Bypass Meter Mains

320 Amp | 4 Terminal | Ringless | 120/240 VAC

**17**  
320 AMP  
LEVER BYPASS  
METER MAINS



U5059-X-2/200



U5890-X-2/200-BL  
(shown with lugs installed)



U5891-X-2/200-MLK-BL

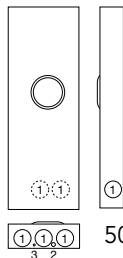

5059

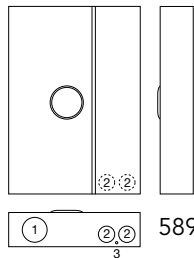

5890

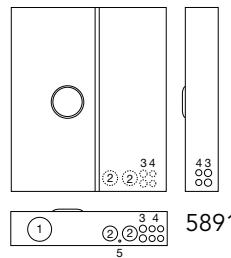

5891

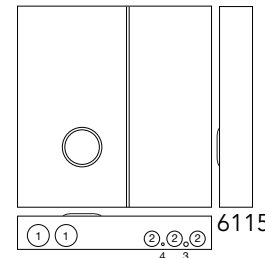

6115

320 Amp | 4 & 7 Terminal | Meter Mains | Lever Bypass | Ringless

Catalog Number	Terms.	Service	Hub	Connectors CU/AL - Line	Breaker Amps	Branch Circuits	Dimensions			Knockouts				
							D"	W"	H"	1	2	3	4	5
U5059-X-K3L	4	OH/UG	C.P.	(1) #4-600 or (2) 1/0-250	Provision	N/A	4 <sup>7</sup> / <sub>8</sub>	15	42	3	1/4, 1/2	1/4	—	—
U5059-X-2/200-K3L	4	OH/UG	C.P.	(1) #4-600 or (2) 1/0-250	200	N/A	4 <sup>7</sup> / <sub>8</sub>	15	42	3	1/4, 1/2	1/4	—	—
U5890-X-2/200-BL*	4	OH/UG	C.P.	3/8" x 16 Studs	200	N/A	6	24 <sup>1</sup> / <sub>2</sub>	35	4	2 <sup>1</sup> / <sub>2</sub>	1/4	—	—
U5890-X-2/200-BLG	4	OH/UG	C.P.	3/8" x 16 Studs	200	N/A	6	24 <sup>1</sup> / <sub>2</sub>	35	4	2 <sup>1</sup> / <sub>2</sub>	1/4	—	—
U5891-X-2/200-MLK-BL*	4	OH/UG	C.P.	3/8" x 16 Studs	200	12	6	29 <sup>1</sup> / <sub>2</sub>	35	4	2 <sup>1</sup> / <sub>2</sub>	1	1/2, 3/4	1/4
U6115-X-2/200-K7L**	7	OH/UG	C.P.	#4-600 kcmil or (2) 1/0-250	200	N/A	7	34 <sup>1</sup> / <sub>4</sub>	34	4	2 <sup>1</sup> / <sub>2</sub>	1/2	1/4	—

## Notes

- **AIC Rating:** 22K AIC standard.
- **Breakers:** For **U5059** main breakers, order **UQFPH-100, -150, or -200**.
- **-MLK:** Main Lug feed-through kit **K3701** factory installed.
- **Fifth Terminal:** For field mounted fifth terminal order catalog number **K3865**.
- Supplied with 3/8" x 16 hex head nuts with Belleville washers. For connector kits, order as extra **K1540** (single 600 kcmil). For twin lug connectors, order as extra **K1350** (twin 350 kcmil). The Extra stud on line side is a wire stop
- \* Barrel lock (suffix -BL).
- \*\*7 Terminal 3-phase 4-wire.
- **Product numbers with BLG are used in AEP service areas.**

Please consult serving utility for their requirements prior to ordering or installing, as specifications and approvals vary by utility, and may require local electrical inspector approval. All installations must be installed by a licensed electrician and must comply with all national and local codes, laws and regulations. Milbank reserves the right to make changes in specifications and features shown without notice or obligation.



# Lever Bypass Meter Mains **with 400A Breaker**

320 Amp | 4 & 7 Terminal | Ringless | Jaw Clamping

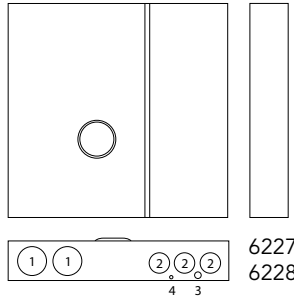

U6228-X-400-K3

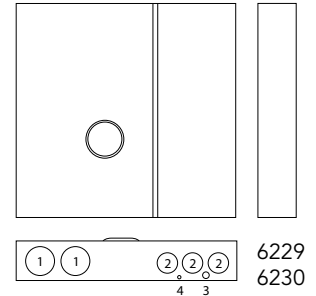

U6230-X-400-K7

## 320 Amp | 4 Terminal | Meter Mains | Lever Bypass | Ringless

Catalog Number	Service	Hub	Connectors CU/AL	Dimensions			Knockouts			
			Line	D"	W"	H"	1	2	3	4
U6227-X-400-k3	OH/UG	C.P.	600 kcmil	6	36¼	34	4	2½	½	¼
*U6228-X-400-K3	OH/UG	C.P.	600 kcmil	6	36¼	34	4	2½	½	¼

## 320 Amp | 7 Terminal | Meter Mains | Lever Bypass | Ringless

Catalog Number	Service	Hub	Connectors CU/AL	Dimensions			Knockouts			
			Line	D"	W"	H"	1	2	3	4
U6229-X-400-K7	OH/UG	C.P.	600 kcmil	6	36¼	34	4	2½	½	¼
*U6230-X-400-K7	OH/UG	C.P.	600 kcmil	6	36¼	34	4	2½	½	¼

## Notes

- **Short Circuit Current Rating:** 22K AIC at 120/240 Volts or 10K at 480 Volts.
- \***Side Bussing:** U6228 and U6230 have side bussing.



Please consult serving utility for their requirements prior to ordering or installing, as specifications and approvals vary by utility, and may require local electrical inspector approval. All installations must be installed by a licensed electrician and must comply with all national and local codes, laws and regulations. Milbank reserves the right to make changes in specifications and features shown without notice or obligation.

# Cold Sequence Meter Mains

4, 5 & 7 Terminal | Ringless



U5767-X-200-CB



U5787-O-200-CB

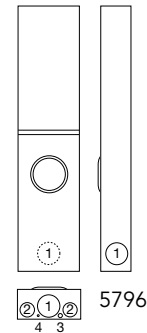

5796

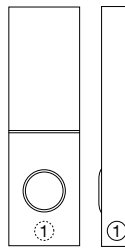

5764 5767  
5765

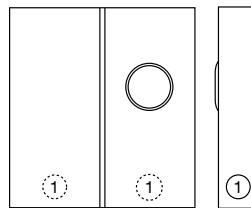

5784 5787

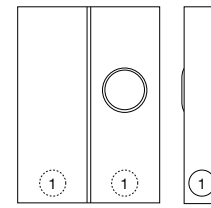

5797 5799

## 200 Amp Circuit Breaker Disconnect Ahead Of Meter Socket | Lever Bypass

Catalog Number	Terminals	Service	Hub	Connectors CU/AL - Load	Phase	Dimensions			Knockouts			
						D"	W"	H"	1	2	3	4
U5764-X-200-CB	4	OH/UG	C.P.	#6-350	1Ø3W	4 <sup>27/32</sup>	13	43	4	2½	¼	—
U5765-X-200-CB	5	OH/UG	C.P.	#6-350	1Ø3W or 3Ø3W	4 <sup>27/32</sup>	13	43	4	2½	1	½, ¾
U5784-O-200-CB	5	UG	Blank	#6-350	1Ø3W or 3Ø3W	4 <sup>27/32</sup>	26	28	4	2½	¼	—
U5767-X-200-CB	7	OH/UG	C.P.	#6-350	3Ø4W	4 <sup>27/32</sup>	13	43	4	2½	1	½, ¾
U5787-O-200-CB	7	UG	Blank	#6-350	3Ø4W	6	26	28	4	2½	1	½, ¾

## 400 Amp (320 Amp Continuous) Circuit Breaker Disconnect Ahead Of Meter Socket | Lever Bypass

Catalog Number	Terminals	Service	Hub	Connectors CU/AL - Load	Phase	Dimensions			Knockouts			
						D"	W"	H"	1	2	3	4
U5797-O-400-CB	5	UG	Blank	3/0-500	1Ø3W or 3Ø3W	6	26	36	4	2½	1	½, ¾
U5796-X-400-CB	7	OH/UG	C.P.	3/0-500	3Ø4W	6	13	56	4	2½	¼	—
U5799-O-400-CB	7	UG	Blank	3/0-500	3Ø4W	6	26	36	4	2½	1	½, ¾

### Notes

- **Hubs:** For proper hub selection, refer to the hub suffix chart on the accessories page.

Please consult serving utility for their requirements prior to ordering or installing, as specifications and approvals vary by utility, and may require local electrical inspector approval. All installations must be installed by a licensed electrician and must comply with all national and local codes, laws and regulations. Milbank reserves the right to make changes in specifications and features shown without notice or obligation.



# Multi-Position Sockets

150 Amp | 4 Terminal | Ringless | 300 VAC



U1232-RRL-KK-K1

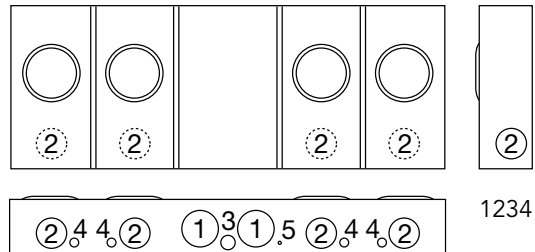
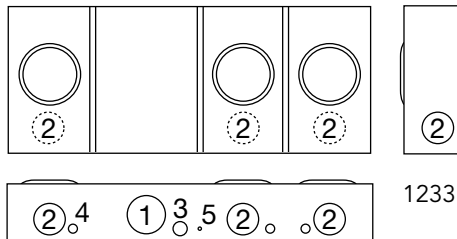
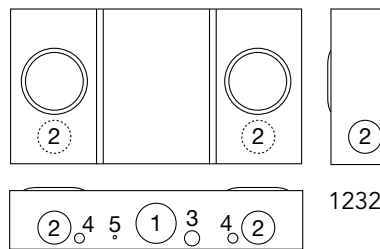

150 Amp per Position | 4 Terminal | Multi-Position | Ringless | Horn Bypass

Catalog Number	Positions	Service	Hub	Connectors CU/AL		Dimensions			Knockouts				
				Line	Load	D"	W"	H"	1	2	3	4	5
U1232-RRL-KK-K1	2	OH/UG	H.O.	#6-350	#6-350	5½	26½	14	3	2½	1	½	¼
U1233-RRL-KK-K1	3	OH/UG	H.O.	#6-350	#6-350	5½	34¾	14	3	2½	1	½	¼
U1234-RXL-KK-K1	4	OH/UG	C.P.	#6-350	#6-350	5½	42⅞	16	3	2½	1	½	¼

## Notes

- **Hubs:** For proper hub selection, refer to the hub suffix chart on the accessories page. For the **U1254-6** two hub openings are supplied and the extra opening is closed with a closing plate as standard.
- **Fifth Terminal:** For field mounted fifth terminal, order catalog number **K5T** (9 o'clock position).



Please consult serving utility for their requirements prior to ordering or installing, as specifications and approvals vary by utility, and may require local electrical inspector approval. All installations must be installed by a licensed electrician and must comply with all national and local codes, laws and regulations. Milbank reserves the right to make changes in specifications and features shown without notice or obligation.



# Multi-Position Sockets

200 Amp | 4 Terminal | Ringless | 300 VAC

**21**  
200 AMP  
MULTI-  
POSITION



U1252-RRL-KK-K1-SLVG

200 Amp per Position | 4 Terminal | Multi-Position | Ringless | Horn Bypass

Catalog Number	Positions	Service	Hub	Connectors CU/AL		Dimensions		
				Line	Load	D"	W"	H"
U1252-RRL-KK-K1-SLVG	2	OH/UG	H.O.	#6-350	#6-350	5 $\frac{1}{8}$	26 $\frac{1}{2}$	14
U1252-RRL-KK-K1-BLG-SLVG	2	OH/UG	H.O.	#6-350	#6-350	5 $\frac{1}{8}$	26 $\frac{1}{2}$	14
U1253-RRL-KK-K1-SLVG	3	OH/UG	H.O.	#6-350	#6-350	5 $\frac{1}{8}$	34 $\frac{3}{4}$	14
U1253-RRL-KK-K1-BLG-SLVG	3	OH/UG	H.O.	#6-350	#6-350	5 $\frac{1}{8}$	34 $\frac{3}{4}$	14
U1254-RXL-KK-K1-SLVG	4	OH/UG	C.P.	#6-350	#6-350	5 $\frac{1}{8}$	42 $\frac{7}{8}$	16
U1254-RXL-KK-K1-BLG-SLVG	4	OH/UG	H.O.	#6-350	#6-350	5 $\frac{1}{8}$	42 $\frac{7}{8}$	16
U1255-RXL-KK-K1-SLVG	5	OH/UG	C.P.	#6-350	#6-350	5 $\frac{1}{8}$	54 $\frac{1}{2}$	16
U1255-RXL-KK-K1-BLG-SLVG	5	OH/UG	H.O.	#6-350	#6-350	5 $\frac{1}{8}$	54 $\frac{1}{2}$	16
U1256-RXL-KK-K1-SLVG	6	OH/UG	C.P.	#6-350	#6-350	5 $\frac{1}{8}$	63 $\frac{1}{16}$	18
U1256-RXL-KK-K1-BLG-SLVG	6	OH/UG	H.O.	#6-350	#6-350	5 $\frac{1}{8}$	63 $\frac{1}{16}$	18

## Notes

- **Hubs:** For proper hub selection, refer to the hub suffix chart on the accessories page. For the **U1254-6** two hub openings are supplied and the extra opening is closed with a closing plate as standard.
- **Fifth Terminal:** For field mounted fifth terminal, order catalog number **K5T** (9 o'clock position).
- **Product numbers with BLG are used in AEP service areas.**

Please consult serving utility for their requirements prior to ordering or installing, as specifications and approvals vary by utility, and may require local electrical inspector approval. All installations must be installed by a licensed electrician and must comply with all national and local codes, laws and regulations. Milbank reserves the right to make changes in specifications and features shown without notice or obligation.



# Multi-Position Sockets

*Knockout information*

Knockouts				
1	2	3	4	5
3	2½	1	½	¼

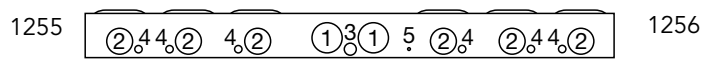
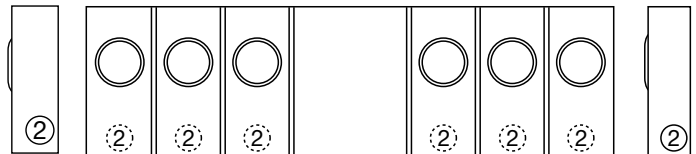
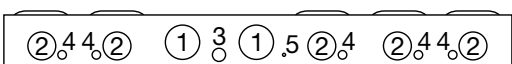
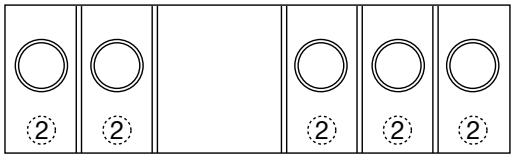
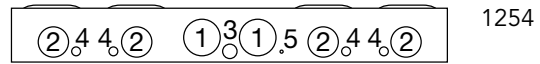
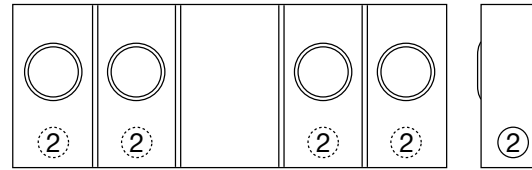
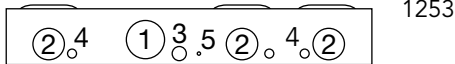
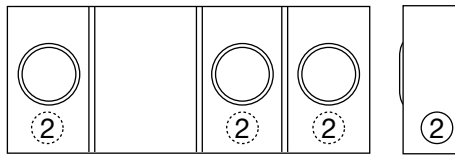
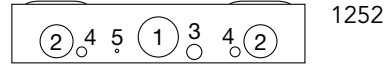
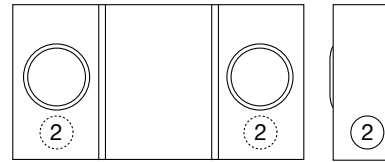

Please consult serving utility for their requirements prior to ordering or installing, as specifications and approvals vary by utility, and may require local electrical inspector approval. All installations must be installed by a licensed electrician and must comply with all national and local codes, laws and regulations. Milbank reserves the right to make changes in specifications and features shown without notice or obligation.

# Lever Bypass Multi-Position Sockets

200 Amp | 5 Terminal | Ringless | 600 VAC

**23**  
200 AMP  
LEVER BYPASS  
MULTI-  
POSITION



U2873-XT

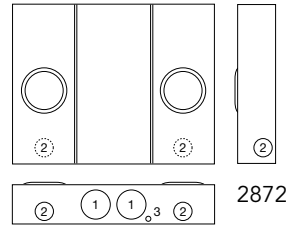

2872

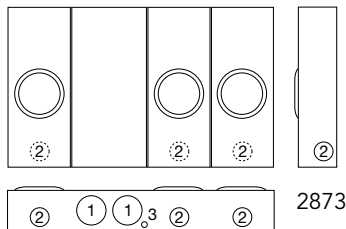

2873

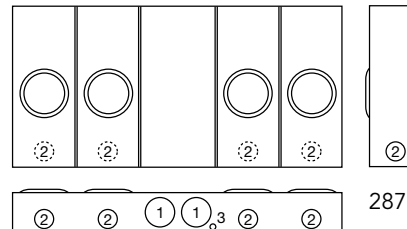

2874

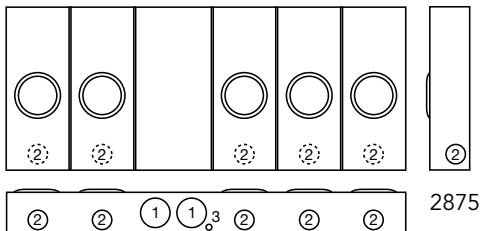

2875

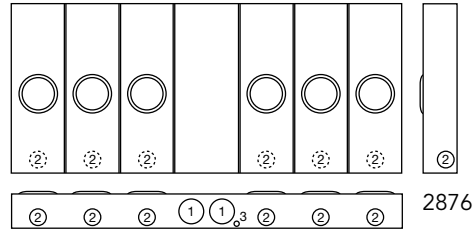

2876

200 Amp per Position | 5 Terminal | Multi-Position | OH/UG | Ringless

Catalog Number	Positions	Hub	Connectors CU/AL		Bypass	Dimensions			Knockouts		
			Line	Load		D"	W"	H"	1	2	3
U2872-XT	2	(2) C.P.	3/8" x 16 Stud	#6-350	Lever	6	32 1/8	25 1/4	4	2 1/2	1/4, 1/2
U2873-XT	3	(2) C.P.	3/8" x 16 Stud	#6-350	Lever	6	42 3/16	25 1/4	4	2 1/2	1/4, 1/2
U2874-XT	4	(2) C.P.	3/8" x 16 Stud	#6-350	Lever	6	52 1/4	25 1/4	4	2 1/2	1/4, 1/2
U2875-XT	5	(2) C.P.	3/8" x 16 Stud	#6-350	Lever	6	62 5/16	25 1/4	4	2 1/2	1/4, 1/2
U2876-XT	6	(2) C.P.	3/8" x 16 Stud	#6-350	Lever	6	72 3/8	31 1/4	4	2 1/2	1/4, 1/2

## Notes

- **Hubs:** Units supplied with two closing plates. To order hubs as extra, refer to the hub suffix chart on the accessories page.
- **Connector Kits:** For line side connector kits, order as extra **K1539** (350 kcmil), **K1540** (600 kcmil), twin **K1350** (350 kcmil), twin **K1541** (600 kcmil). Line connectors can be reversed to change from "OH" to "UG" service. For line side connector lug kits, order as extra from chart on the accessories page.
- **Bypass:** Lever supplies clamping action on meter spades and also operates bypass device.

Please consult serving utility for their requirements prior to ordering or installing, as specifications and approvals vary by utility, and may require local electrical inspector approval. All installations must be installed by a licensed electrician and must comply with all national and local codes, laws and regulations. Milbank reserves the right to make changes in specifications and features shown without notice or obligation.



# 24

200 AMP  
LEVER BYPASS  
MULTI-  
POSITION

# Lever Bypass Multi-Position Sockets

200 Amp | 7 Terminal | Ringless | 600 VAC 3 phase

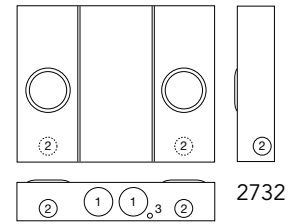

U2732-XT

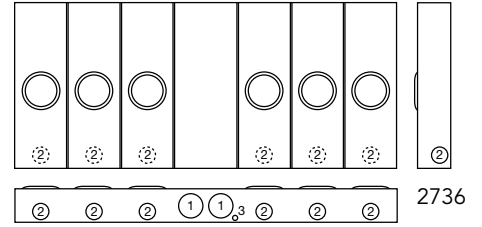
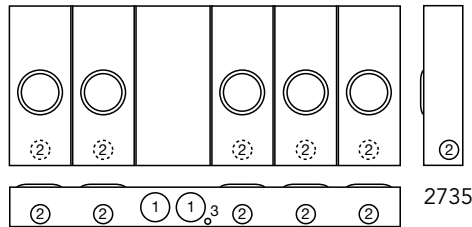
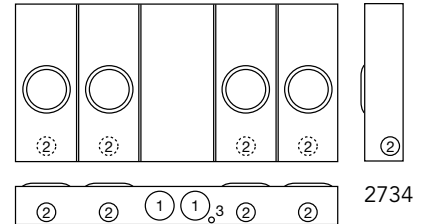
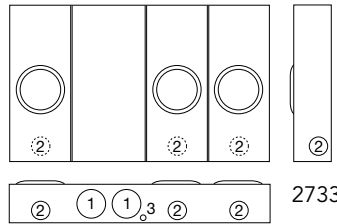

200 Amp per Position | 7 Terminal | Multi-Position | OH/UG | Lever Bypass | Ringless

Catalog Number	Positions	Hub	Connectors CU/AL		Dimensions			Knockouts		
			Line	Load	D"	W"	H"	1	2	3
U2732-XT	2	(2) C.P.	3/8" x 16 Stud	#6-350	6	32 1/8	25 1/4	4	2 1/2	1/4, 1/2
U2733-XT	3	(2) C.P.	3/8" x 16 Stud	#6-350	6	42 3/16	25 1/4	4	2 1/2	1/4, 1/2
U2734-XT	4	(2) C.P.	3/8" x 16 Stud	#6-350	6	52 1/4	25 1/4	4	2 1/2	1/4, 1/2
U2735-XT	5	(2) C.P.	3/8" x 16 Stud	#6-350	6	62 5/16	25 1/4	4	2 1/2	1/4, 1/2
U2736-XT	6	(2) C.P.	3/8" x 16 Stud	#6-350	6	72 3/8	31 1/4	4	2 1/2	1/4, 1/2

## Notes

- **Hubs:** Units supplied with two closing plates. To order hubs as extra, refer to the hub suffix chart on the accessories page.
- **Connector Kits:** For line side connector kits, order as extra **K3082** (350 kcmil), **K3441** (600 kcmil), twin **K3442** (350 kcmil), twin **K3083** (600 kcmil). Line connectors can be reversed to change from "OH" to "UG" service.
- **Bypass:** Lever supplies clamping action on meter spades and also operates bypass device.



Please consult serving utility for their requirements prior to ordering or installing, as specifications and approvals vary by utility, and may require local electrical inspector approval. All installations must be installed by a licensed electrician and must comply with all national and local codes, laws and regulations. Milbank reserves the right to make changes in specifications and features shown without notice or obligation.

# Multi-Position Meter Mains

125 & 200 Amp/Position | 4 Terminal | Ringless | 120/240 VAC

**25**  
125 & 200 AMP  
MULTI-  
POSITION  
METER MAINS



**U2854-X**

(Order circuit breakers separately)



**U2866-X**

## 125 Amp Per Position | Multi-Position Sockets | Ringless

Catalog Number	Amps Per Position	Positions	Main Bus Rating	Line Connector Size	Dimensions		
					D"	W"	H"
U2852-X	125	2	200 Amp	3/8" x 16 Stud*	5 13/16	18	25
U2853-X	125	3	200 Amp	3/8" x 16 Stud*	5 13/16	18	37
U2854-X	125	4	400 Amp	3/8" x 16 Stud*	4 7/8	31	25
U2855-X	125	5	400 Amp	3/8" x 16 Stud*	4 7/8	31	37
U2856-X	125	6	400 Amp	3/8" x 16 Stud*	4 7/8	31	37

## 200 Amp Per Position | Multi-Position Sockets | Ringless

Catalog Number	Amps Per Position	Positions	Main Bus Rating	Line Connector Size	Dimensions		
					D"	W"	H"
U2862-X	200	2	250 Amp	3/8" x 16 Stud*	5 13/16	21	29
U2863-X	200	3	300 Amp	3/8" x 16 Stud*	5 13/16	21	41
U2864-X	200	4	400 Amp	3/8" x 16 Stud*	4 7/8	36	29
U2865-X	200	5	600 Amp	3/8" x 16 Stud*	4 7/8	36	41
U2866-X	200	6	600 Amp	3/8" x 16 Stud*	4 7/8	36	41

### Connector Kits\*

Size	Suffix	Kit Number	Compatible With	Wire Range
Single	-K1	<b>K1539</b>	U2852-56, U2862-66	#6-350
	-K3	<b>K1540</b>	U2854-56, U2864-66	#4-600
Twin	-K2	<b>K1350</b>	U2854-56, U2863-66	#6-350
	-K4	<b>K1541</b>	U2864-66	#2-600

### Breaker Chart

Manufacturer	150-200 Amps	125 Amps or Less
Milbank	WBJ	—
Cutler Hammer	BR, BJ	Quicklag P, BR, HQP
Siemens	QNR	QP
Siemens/Murray	MD	MP
G.E.	Q Line	Q Line
Square D	—	Homeline

### Notes

- **Connectors:** For line wire connector kits, order separately.
- **Fifth Terminal:** For field mounted fifth terminal, order catalog number **K2381**. Order one per meter position.
- **Breakers:** Units have provision for one double pole main per meter position. Breakers not included.
- **Short Circuit Current Rating:** 10K AIC. However, this rating is limited to the lowest interrupting capacity of any circuit breaker installed. Watthour meter not included in short circuit current rating.
- **Knockouts:** See next page for drawings and knockout configurations.

Please consult serving utility for their requirements prior to ordering or installing, as specifications and approvals vary by utility, and may require local electrical inspector approval. All installations must be installed by a licensed electrician and must comply with all national and local codes, laws and regulations. Milbank reserves the right to make changes in specifications and features shown without notice or obligation.



# Multi-Position Meter Mains

## Knockout Information

Catalog Number	Knockouts		
	1	2	3
U2852-X	3	1¼	¼, ½
U2853-X	3	1¼	¼, ½
U2854-X	3	1¼	¼, ½
U2855-X	3	1¼	¼, ½
U2856-X	3	1¼	¼, ½
U2862-X	3	2	¼, ½
U2863-X	3	2	¼, ½
U2864-X	3	2	¼, ½
U2865-X	3	2	¼, ½
U2866-X	3	2	¼, ½

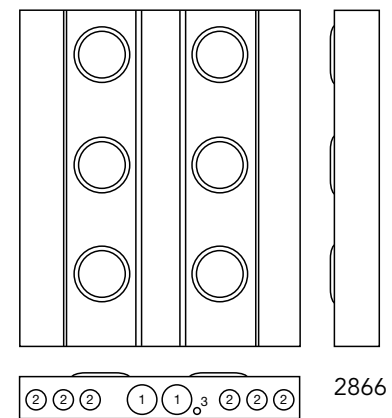
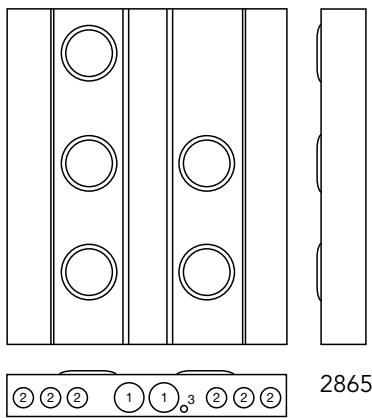
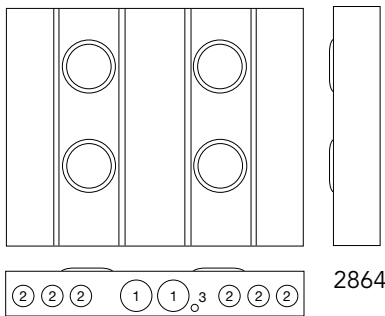
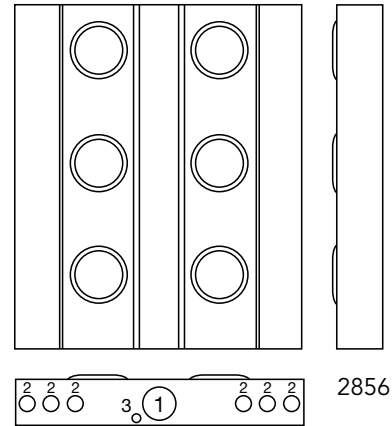
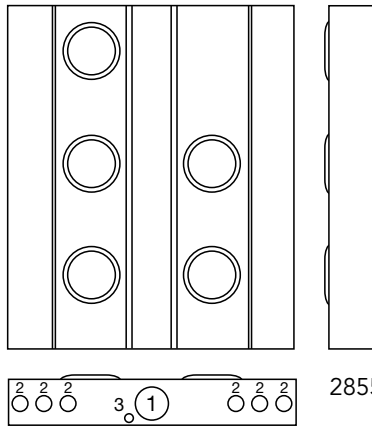
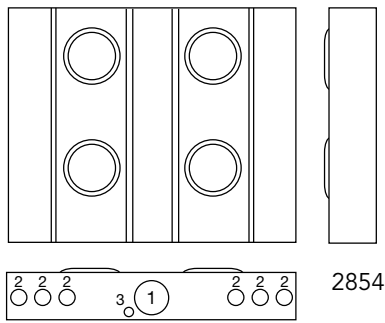
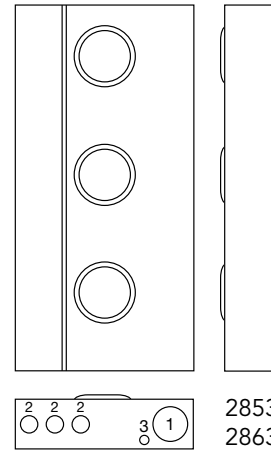
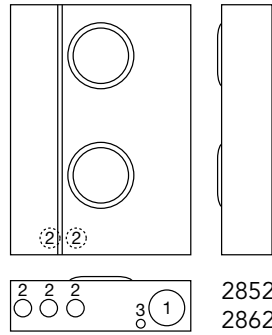

Please consult serving utility for their requirements prior to ordering or installing, as specifications and approvals vary by utility, and may require local electrical inspector approval. All installations must be installed by a licensed electrician and must comply with all national and local codes, laws and regulations. Milbank reserves the right to make changes in specifications and features shown without notice or obligation.

# Multi-Position Meter Mains

125-200 Amp | 4 Terminal | Ringless | 120/240 VAC | 22KAIC

**27**  
125-200 AMP  
MULTI-  
POSITION  
METER MAINS



U5882-X-KK-BLG



U5884-X-KK-BLG

## 125 Amp per Position | 4 Terminal | Multi-Position Meter Main | Ringless

Catalog Number	Amps	Positions	Service	Hub	Connectors CU/AL	Bypass	Dimensions			Weight (lbs.)
					Line		D"	W"	H"	
U5902-X-KK-BLG	125	2	OH/UG	C.P.	3/8" x 16 Stud	Horn	5 1/8"	26 1/2"	30"	58
U5903-X-KK-BLG	125	3	OH/UG	C.P.	3/8" x 16 Stud	Horn	5 1/8"	34 5/8"	30"	88
U5904-X-KK-BLG	125	4	OH/UG	C.P.	3/8" x 16 Stud	Horn	5 1/8"	42 5/8"	30"	107
U5905-X-KK-BLG	125	5	OH/UG	C.P.	3/8" x 16 Stud	Horn	5 1/8"	51 1/20"	30"	128
U5906-X-KK-BLG	125	6	OH/UG	C.P.	3/8" x 16 Stud	Horn	5 1/8"	59 3/10"	30"	146

## 200 Amp per Position | 4 Terminal | Multi Position Meter Main | Ringless

Catalog Number	Amps	Positions	Service	Hub	Connectors CU/AL	Bypass	Dimensions			Weight (lbs.)
					Line		D"	W"	H"	
U5882-X-KK-BLG	200	2	OH/UG	C.P.	3/8" x 16 Stud	Horn	5 1/8"	26 1/2"	30"	58
U5883-X-KK-BLG	200	3	OH/UG	C.P.	3/8" x 16 Stud	Horn	5 1/8"	34 5/8"	30"	88
U5884-X-KK-BLG	200	4	OH/UG	C.P.	3/8" x 16 Stud	Horn	5 1/8"	42 5/8"	30"	107
U5885-X-KK-BLG	200	5	OH/UG	C.P.	3/8" x 16 Stud	Horn	5 1/8"	51 1/20"	30"	128
U5886-X-KK-BLG	200	6	OH/UG	C.P.	3/8" x 16 Stud	Horn	5 1/8"	59 3/10"	30"	146

## Notes

- **Knockouts:** See drawings on the next page.
- **Optional:** Factory installed breakers are available - consult factory.
- **AIC Rating:** All models are rated 22K AIC when used with approved breakers rated at 22K.
- **Hub:** Units supplied with one (1) closing plate. Order hubs separately, see accessory page.
- **Fifth Terminal:** For field installed fifth terminal, order K5T.
- **Connectors:** Socket is supplied with 3/8" - 16 hex head nuts with Belleville washers. For connector lug kits, order as extra from chart on the accessories page. Separate lug kits are required for line and load.

Please consult serving utility for their requirements prior to ordering or installing, as specifications and approvals vary by utility, and may require local electrical inspector approval. All installations must be installed by a licensed electrician and must comply with all national and local codes, laws and regulations. Milbank reserves the right to make changes in specifications and features shown without notice or obligation.



# 28

125/200 AMP  
MULTI-  
POSITION  
METER MAINS

# Multi-Position Meter Mains

## Dimensional Information

Knockouts				
1	2	3	4	5
3	2½	1	¾	¼

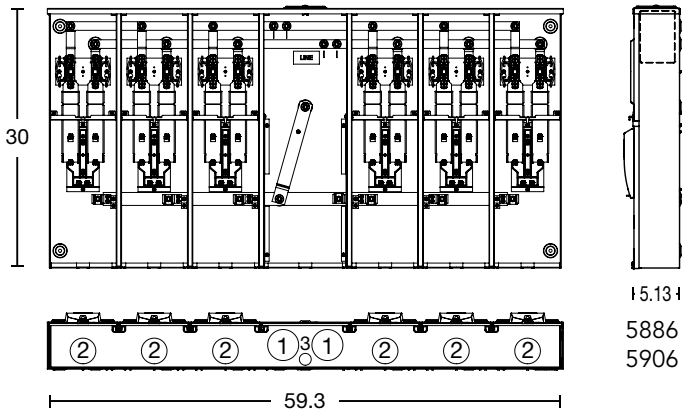
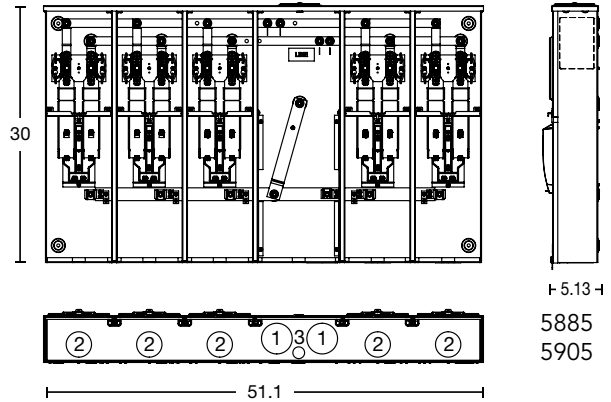
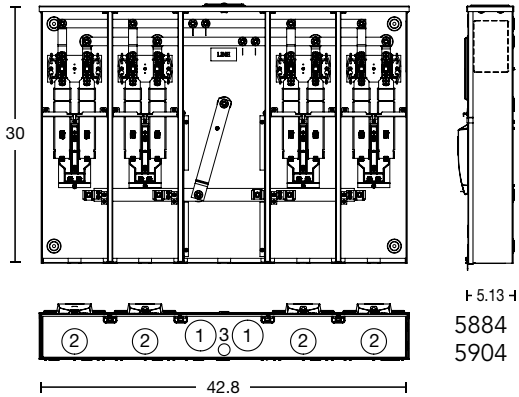
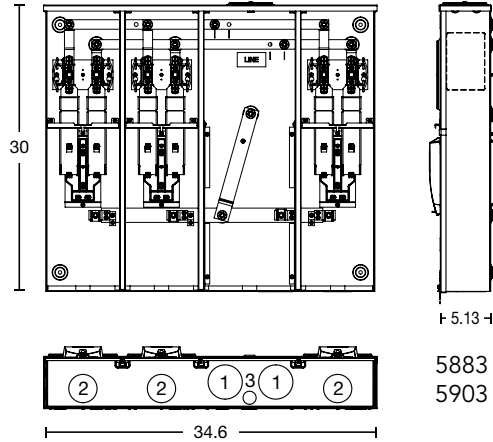
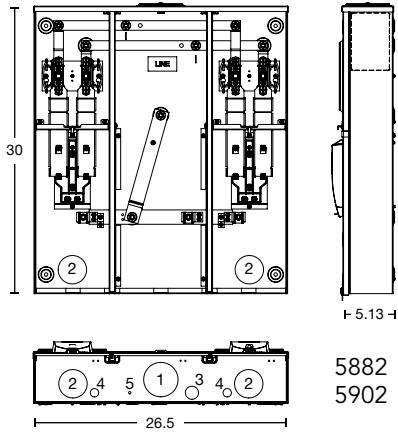

Please consult serving utility for their requirements prior to ordering or installing, as specifications and approvals vary by utility, and may require local electrical inspector approval. All installations must be installed by a licensed electrician and must comply with all national and local codes, laws and regulations. Milbank reserves the right to make changes in specifications and features shown without notice or obligation.



# Transformer Rated

20 Amp | Plunger Bypass | Ringless & Ring Type

**29**  
20 AMP  
TRANSFORMER  
RATED



UC7235

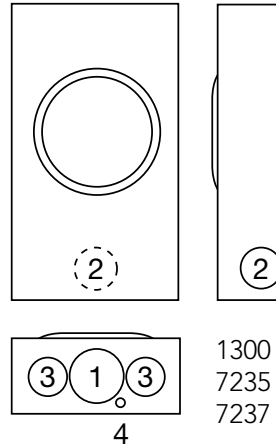

## 1 Piece Cover | Overhead/Underground | Ringless

Catalog Number	Terminals	Type	Hub	Meter Form	Connectors CU	Dimensions			Knockouts			
						D"	W"	H"	1	2	3	4
UC1299-RL	6	Ringless	H.O.	4S	#14-#4 MAX	3 <sup>5</sup> / <sub>16</sub>	8	14	2	1 <sup>1</sup> / <sub>2</sub>	1 <sup>1</sup> / <sub>4</sub>	1 <sup>1</sup> / <sub>4</sub>
UC7235-RL	8	Ringless	H.O.	5S	#14-#4 MAX	3 <sup>5</sup> / <sub>16</sub>	8	14	2	1 <sup>1</sup> / <sub>2</sub>	1 <sup>1</sup> / <sub>4</sub>	1 <sup>1</sup> / <sub>4</sub>
UC7237-XL	13	Ringless	C.P.	6, 8, 9	#14-#4 MAX	3 <sup>5</sup> / <sub>16</sub>	8	14	2	1 <sup>1</sup> / <sub>2</sub>	1 <sup>1</sup> / <sub>4</sub>	1 <sup>1</sup> / <sub>4</sub>

## 1 Piece Cover | Overhead/Underground | Ring Type

Catalog Number	Terminals	Type	Hub	Meter Form	Connectors CU	Dimensions			Knockouts			
						D"	W"	H"	1	2	3	4
UC1300-RL	6	Ring Type	H.O.	4S	#14-#4 MAX	3 <sup>5</sup> / <sub>16</sub>	8	14	2	1 <sup>1</sup> / <sub>2</sub>	1 <sup>1</sup> / <sub>4</sub>	1 <sup>1</sup> / <sub>4</sub>

## Notes

- **Hubs:** For proper hub selection see the hub suffix chart on the accessory page.

Please consult serving utility for their requirements prior to ordering or installing, as specifications and approvals vary by utility, and may require local electrical inspector approval. All installations must be installed by a licensed electrician and must comply with all national and local codes, laws and regulations. Milbank reserves the right to make changes in specifications and features shown without notice or obligation.



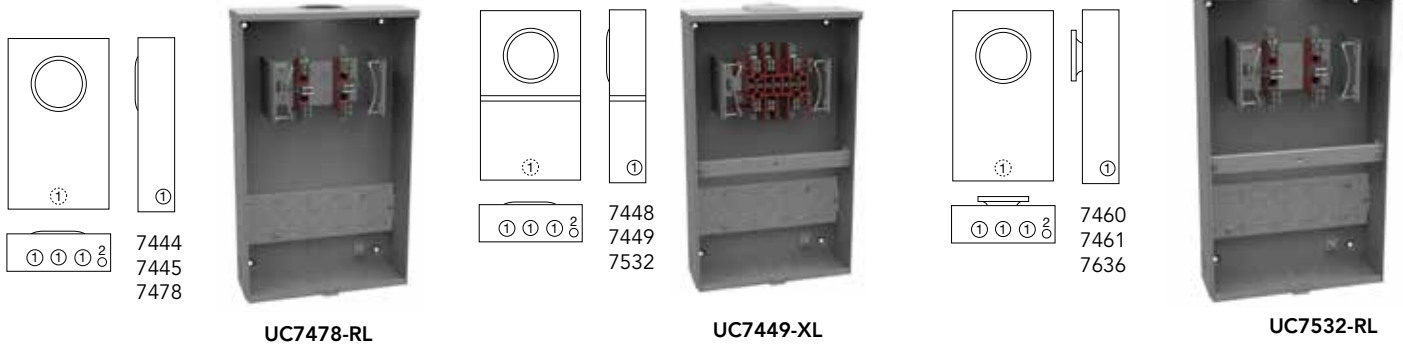

### 1 Piece Cover | Ringless | Overhead/Underground | with test switch provision

Catalog Number	Terminals	Hub	Meter Form	Connectors CU	Bypass	Dimensions			Knockouts	
						D"	W"	H"	1	2
UC7478-RL	6	H.O.	4S	#14 - #4 Max	None	4 $\frac{1}{8}$	12	20	1 $\frac{1}{4}$	$\frac{1}{4}$ , $\frac{1}{2}$
UC7444-RL	8	H.O.	5S	#14 - #4 Max	None	4 $\frac{1}{8}$	12	20	1 $\frac{1}{4}$	$\frac{1}{4}$ , $\frac{1}{2}$
UC7445-RL	13	H.O.	6, 8, 9	#14 - #4 Max	None	4 $\frac{1}{8}$	12	20	1 $\frac{1}{4}$	$\frac{1}{4}$ , $\frac{1}{2}$
UC7445-RL-641*	13	H.O.	6, 8, 9	#14 - #4 Max	None	4 $\frac{1}{8}$	12	20	1 $\frac{1}{4}$	$\frac{1}{4}$ , $\frac{1}{2}$
UC7445-WL	13	1 in	6, 8, 9	#14 - #4 Max	None	4 $\frac{1}{8}$	12	20	1 $\frac{1}{4}$	$\frac{1}{4}$ , $\frac{1}{2}$

\*Prewired per Lebanon specifications

### 2 Piece Cover | Overhead/Underground | No Lever Bypass | with test switch provision

Ringless Catalog Number	Ring Type Catalog Number	Terminals	Meter Form	Hub	Connectors CU	Dimensions			Knockouts	
						D"	W"	H"	1	2
UC7532-RL	UC7636-RL	6	4S	H.O.	#14 - #4 Max	4 $\frac{1}{8}$	12	20	1 $\frac{1}{4}$	$\frac{1}{4}$ , $\frac{1}{2}$
UC7448-RL	UC7460-RL	8	5S	H.O.	#14 - #4 Max	4 $\frac{1}{8}$	12	20	1 $\frac{1}{4}$	$\frac{1}{4}$ , $\frac{1}{2}$
UC7449-RL	UC7461-RL	13	6, 8, 9	H.O.	#14 - #4 Max	4 $\frac{1}{8}$	12	20	1 $\frac{1}{4}$	$\frac{1}{4}$ , $\frac{1}{2}$

### Notes

- **Hubs:** For proper hub selection see the hub suffix chart on the accessory page.
- **Sealing Rings:** Ring type units are supplied with one MR-2, snap type, sealing ring.
- **Prewiring:** Factory prewiring available.
- **Connectors:** Units are supplied with mechanical type connectors (#4 max). If compression type connectors (#10) are preferred, change catalog prefix to "S" (i.e., UC7445-XL becomes S7445-XL). The "S" prefix also designates not UL listed.



Please consult serving utility for their requirements prior to ordering or installing, as specifications and approvals vary by utility, and may require local electrical inspector approval. All installations must be installed by a licensed electrician and must comply with all national and local codes, laws and regulations. Milbank reserves the right to make changes in specifications and features shown without notice or obligation.

# Lever Bypass Transformer Rated

80 Amp | 6, 8 & 13 Terminal

**31**  
80 AMP  
TRANSFORMER  
RATED



U4490-XL

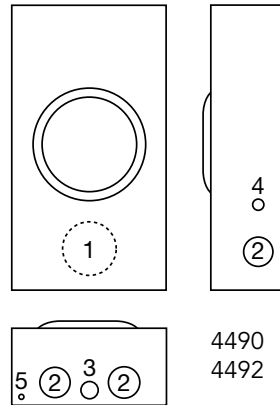

## 80 Amp | Ringless | Transformer Rated | Lever Bypass

Catalog Number	Terminals	Service	Hub	Meter Form	Connectors CU	Dimensions			Knockouts				
						D"	W"	H"	1	2	3	4	5
U4490-XL	6	OH/UG	C.P.	4S	#14 - #4 Max	4 <sup>7</sup> / <sub>8</sub>	10	18 <sup>1</sup> / <sub>2</sub>	3	1 <sup>1</sup> / <sub>2</sub>	1 <sup>1</sup> / <sub>2</sub> , <sup>3</sup> / <sub>4</sub>	<sup>3</sup> / <sub>4</sub>	<sup>1</sup> / <sub>4</sub>
U4492-XL	8	OH/UG	C.P.	5S	#14 - #4 Max	4 <sup>7</sup> / <sub>8</sub>	10	18 <sup>1</sup> / <sub>2</sub>	3	1 <sup>1</sup> / <sub>2</sub>	1 <sup>1</sup> / <sub>2</sub> , <sup>3</sup> / <sub>4</sub>	<sup>3</sup> / <sub>4</sub>	<sup>1</sup> / <sub>4</sub>
U4493-XL	13	OH/UG	C.P.	6, 8, 9	#14 - #4 Max	4 <sup>7</sup> / <sub>8</sub>	10	18 <sup>1</sup> / <sub>2</sub>	3	1 <sup>1</sup> / <sub>2</sub>	1 <sup>1</sup> / <sub>2</sub> , <sup>3</sup> / <sub>4</sub>	<sup>3</sup> / <sub>4</sub>	<sup>1</sup> / <sub>4</sub>

## Notes

- **Hubs:** For proper hub selection see the hub suffix chart on the accessory page.
- **Bypass:** Lever operates current bypass device and also supplies clamping action on current meter spades.
- **Connectors:** Units are supplied with mechanical type connectors (#4 max).

Please consult serving utility for their requirements prior to ordering or installing, as specifications and approvals vary by utility, and may require local electrical inspector approval. All installations must be installed by a licensed electrician and must comply with all national and local codes, laws and regulations. Milbank reserves the right to make changes in specifications and features shown without notice or obligation.



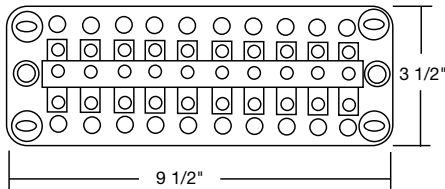
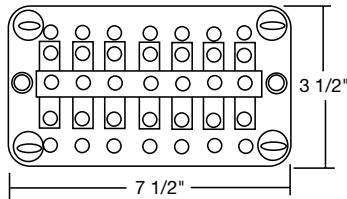
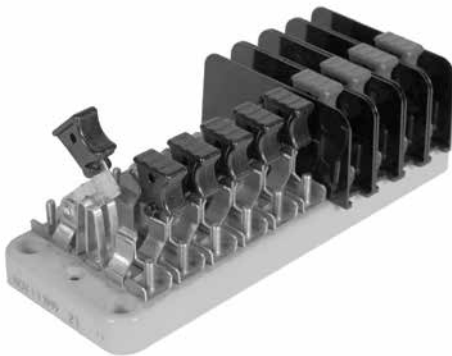

Key	
P	Potential Switch
C+	Line side current switch with short circuit assembly
C	Load side current switch with test jack assembly
N	Neutral bar (no switch)
Pn	Neutral Potential Switch
X	Unused Position on base
	Insulating barrier, isolates both sides of switch

Catalog Number	4-Pole						
TS04-0101	X	P		X	C+	C	X
TS04-0102	X		C+	C	X	Pn	X
TS04-0103	X	P		X	C	C+	X
TS04-0104	X	C+	C	X	P		X

### Notes

- 4-pole switches are also available on 10-pole bases. Contact Milbank for appropriate catalog numbers.

Catalog Number	7-Pole						
TS07-0105		P		C+	C	C+	C
TS07-0106		C+	C		C+	C	
TS07-0107		P		C	C+	C	C+
TS07-0108	C+	C	C+	C		P	

### Notes

- 4-pole switches are also available on 10-pole bases. Contact Milbank for appropriate catalog numbers.

Catalog Number	7-Pole on a 10-Pole Base									
TS07-0049		X		X		X	C+	C	C	C+
TS07-0018		X		X		X	C+	C	C+	C
TS07-0059	X		C+	C		C	C+		X	X
TS07-0022	P	X	P	X	Pn	X	C	C+	C	C+

Catalog Number	10-Pole									
TS10-0109	P		P		C+	C	C+	C	C+	C
TS10-0110		C+	C		C+	C		C+	C	
TS10-0111	P		P		C	C+	C	C+	C	C+
TS10-0112	C+	C	C+	C	C+	C		P		



Please consult serving utility for their requirements prior to ordering or installing, as specifications and approvals vary by utility, and may require local electrical inspector approval. All installations must be installed by a licensed electrician and must comply with all national and local codes, laws and regulations. Milbank reserves the right to make changes in specifications and features shown without notice or obligation.

# Test Switch Worksheet

Electronic version available at [milbankworks.com](http://milbankworks.com)



Customer Name: \_\_\_\_\_

Email: \_\_\_\_\_

Phone: \_\_\_\_\_

Handle Color Key							
BK	Black	P	Purple	Y	Yellow	GN	Green
R	Red	BL	Blue	W	White	BKS	Black Stripe
BR	Brown	GR	Grey	O	Orange	WS	White Stripe

### TEST SWITCH BASE

The base is molded from a high strength, fiberglass reinforced, thermoset polyester. This material is track-resistant, flame-retardant and has low water absorption qualities. Bases are available in two standard sizes following NEMA mounting classifications.

### Pole Position Chart

1	2	3	4	5	6	7	8	9	10

### Special Features

Feature	1	2	3	4	5	6	7	8	9	10
45° Angle Stops										
Ganged Handles (C)										
Bussing										
Colored Handles										

Engineering Information: \_\_\_\_\_

Key	
P	Potential Switch
C+	Line side current switch with short circuit assembly
C	Load side current switch with test jack assembly
N	Neutral bar (no switch)
Pn	Neutral Potential Switch
X	Unused Position on base
	Insulating barrier (one side)
	Insulating barrier (two sides)

**Custom Pole Arrangements:** The key may be used to diagram your own pole arrangement. Be sure to specify base size and whether all C+ line side, current switch/shunt circuit assemblies are to be bussed together. The catalog numbers shown above are connected in line-load pairs; therefore, if bussed is required, different catalog numbers will apply.

### Number of Poles

- 4
- 7
- 10
- Other \_\_\_\_\_

### Test Switch Cover (only available for 10-pole bases)

- Yes | Clear \_\_\_\_ Black \_\_\_\_
- No

### Base Size

- 7-Pole
- 10-Pole

Please consult serving utility for their requirements prior to ordering or installing, as specifications and approvals vary by utility, and may require local electrical inspector approval. All installations must be installed by a licensed electrician and must comply with all national and local codes, laws and regulations. Milbank reserves the right to make changes in specifications and features shown without notice or obligation.





304410-CTC3R



U5990-O

## Outdoor Transformer Cabinets | NEMA 3R

Catalog Number	Dimensions			Gauge of Steel	Board Size		CT Mounting Provisions	# of Doors	Latching Type
	D"	W"	H"		W"	H"			
U4408-O	14	40	40	12	40	40	Wood	2	3 point latch
U4410-O	12	32	24		28	20	Wood	1	Flip latch
S4019-O	10	32	24	14	24	16	Wood	2	3 point latch
S4020-O	10	36	32	14	28	24	Wood	2	3 point latch
S4399-O	10	24	18	14	16	10	Wood	2	3 point latch
S4400-O	10	44	30	14	36	22	Wood	2	3 point latch
304410-CTC3R	10	44	30	12	—	—	None	2	Hasp
243210-CTC3R	10	32	24	14	—	—	None	2	Hasp
363612-LC3R-SP-WB	12	36	36	14	33	33	Rails	1	Wing handle
484812-CT3R-WB	12	48	48	14	44	44	Rails	2	3 point latch
U5990-O	10	36	36	12	CT mounting rack included			2	Flip latch

## Notes

- **Features:** Supplied with solid back board when noted, three point locking handle, lift off hinges with stainless steel pins and padlock provisions.
- **U5990-O:** is 3Ø with a 50K RMS rating, and has a wire range of #4-600 kcmil.
- Non UL listed.
- See utility approval chart on pages 62.



Please consult serving utility for their requirements prior to ordering or installing, as specifications and approvals vary by utility, and may require local electrical inspector approval. All installations must be installed by a licensed electrician and must comply with all national and local codes, laws and regulations. Milbank reserves the right to make changes in specifications and features shown without notice or obligation.

# Meter Main with Load Center Pedestal

200 Amp | 4 Terminal | Ringless | 120/240 VAC

**35**  
200 AMP  
METER MAIN WITH  
LOAD  
CENTER  
PEDESTAL



**U5136-O-200S**  
(shown with 20 amp receptacle and breaker with -10GR suffix)

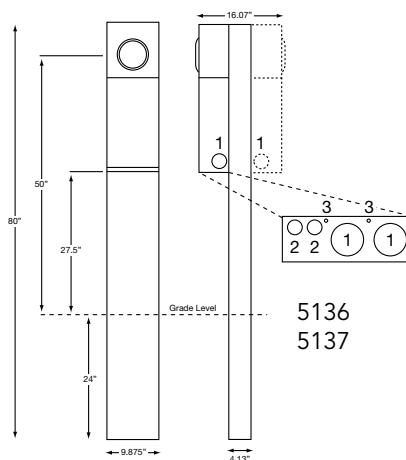

**U6220-O-20**

## 200 Amps | 4 Terminal | Meter Main Pedestal | Ringless

Catalog Number	Breaker Amps	Service	Powerheads	Branch Circuits	Bypass	Connectors CU/AL		Knockouts		
						Line	Load	1	2	3
U5136-O	Provision	UG	Single	4	Horn	#6-350	CB	2	1/2, 3/4	1/4
U5136-O-100S	100	UG	Single	4	Horn	#6-350	CB	2	1/2, 3/4	1/4
U5136-O-200S	200	UG	Single	4	Horn	#6-350	CB	2	1/2, 3/4	1/4
U5137-O-200S	200	UG	Double	4	Horn	#6-350	CB	2	1/2, 3/4	1/4

## 100-200 Amps | 4 Terminal | Meter Main Pedestal | Ringless

Catalog Number	Breaker Amps	Service	Powerheads	Branch Circuits	Bypass	Connectors CU/AL		Knockouts		
						Line	Load	1	2	3
U6220-O-100-KK-10GR	100	UG	Single	10	Horn	#6-350	FTL*	2	1/2, 3/4	1/4
U6220-O-200-KK-10GR	200	UG	Single	8	Horn	#6-350	FTL*	2	1/2, 3/4	1/4

## Notes

- **Parallel to Series Conversion:** For field converting from parallel wired to series wired order **K5194**.
- **Fifth Terminal:** For field installed fifth terminal, order **K5T**.
- **Stabilizer Foot:** For field installed stabilizer foot, order **K5415**.
- **Penta Bolt Locking:** For field installed pedestal fronts penta bolt locking, order **K5039**.
- **Receptacles:** Consult factory for installed receptacle assemblies.
- **Short Circuit Current Rating:** 22K AIC. However, this rating is limited to the lowest interrupting capacity of any circuit breaker installed. Watthour meter not included in short circuit current rating.

\*FTL: Feed Through Lugs

Please consult serving utility for their requirements prior to ordering or installing, as specifications and approvals vary by utility, and may require local electrical inspector approval. All installations must be installed by a licensed electrician and must comply with all national and local codes, laws and regulations. Milbank reserves the right to make changes in specifications and features shown without notice or obligation.



# Temporary Power Units

125 Amp | 4 Terminal | Ringless | 120/240 VAC



U5101-XL-11GR

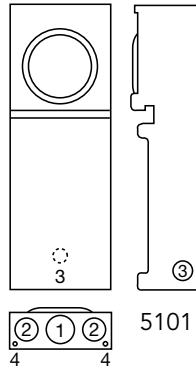

U4908-O-11GR

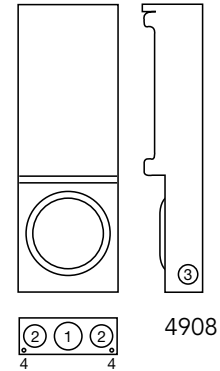

125 Amps | 4 Terminal | Temporary Power Units | Ringless | 1Ø3W

Catalog Number	Service	Hub	Connectors CU/AL		Dimensions			Knockouts				
			Line	Load	D"	W"	H"	1	2	3	4	5
U5101-XL-11GR	OH	C.P.	#6-350	#6-350	5 <sup>3</sup> / <sub>16</sub>	8 <sup>7</sup> / <sub>8</sub>	25	2	1 <sup>1</sup> / <sub>2</sub>	1 <sup>1</sup> / <sub>4</sub>	1 <sup>1</sup> / <sub>4</sub>	—
U4908-O-11GR	UG	Blank	#6-2/0	#6-2/0	5 <sup>3</sup> / <sub>16</sub>	9	25 <sup>15</sup> / <sub>16</sub>	2	1 <sup>1</sup> / <sub>2</sub>	1 <sup>1</sup> / <sub>4</sub>	1 <sup>1</sup> / <sub>4</sub>	—

### Notes

- **Interior:** Six circuit plated copper interior accepts standard plug-in type circuit breakers.
- **Receptacle Bridge:** Three position self-grounded receptacle bridge accepts most standard NEMA receptacles with mounting plates.
- **Included Parts:** U4908 and U5101 come supplied with 2-20 amp single pole breakers and 2-20 amp GFCI receptacles (pre-wired and installed).



Please consult serving utility for their requirements prior to ordering or installing, as specifications and approvals vary by utility, and may require local electrical inspector approval. All installations must be installed by a licensed electrician and must comply with all national and local codes, laws and regulations. Milbank reserves the right to make changes in specifications and features shown without notice or obligation.



# Surface Mount Power Outlet

Millennium Series | Metered & Unmetered | 120/240 VAC

**37**  
SURFACE  
MOUNT POWER  
OUTLET

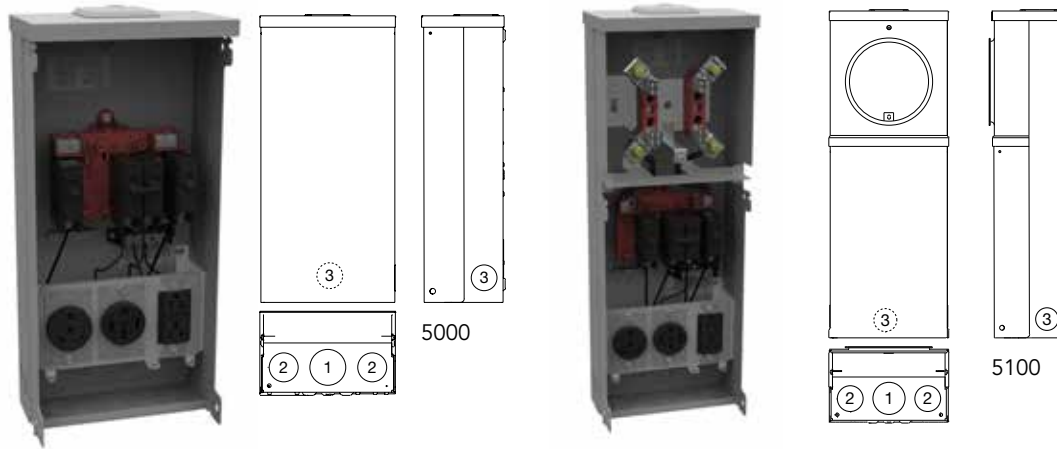

U5000-XL-75

U5100-XL-75

## 125 Amp | Surface Mount Power Outlets

Catalog Number	Metered/Unmetered	Receptacle Configuration	Circuit Breaker Configuration	Loop Feed	Connectors - Line	Dimensions			Knockouts		
						D"	W"	H"	1	2	3
U5000-XL	Unmetered	—	—	Yes	(2) 1/0-#12	5½	9⅞	19¼	2	1½	1¼
U5000-XL-41	Unmetered	A	X	Yes	(2) 1/0-#12	5½	9⅞	19¼	2	1½	1¼
U5000-XL-55	Unmetered	B	Y	Yes	(2) 1/0-#12	5½	9⅞	19¼	2	1½	1¼
U5000-XL-75	Unmetered	C	Z	Yes	(2) 1/0-#12	5½	9⅞	19¼	2	1½	1¼
U5100-XL	Metered	—	—	No	#6-250	5½	9⅞	25	2	1½	1¼
U5100-XL-41	Metered	A	X	No	#6-250	5½	9⅞	25	2	1½	1¼
U5100-XL-55	Metered	B	Y	No	#6-250	5½	9⅞	25	2	1½	1¼
U5100-XL-75	Metered	C	Z	No	#6-250	5½	9⅞	25	2	1½	1¼

### Receptacle Configurations

A	B	C
(1) TT30R, (1) 5-20R GFI	(1) 14-50R, (1) 5-20R GFI	(1) 14-50R, (1) TT30R, (1) 5-20R GFI

**NOTE**  
Contact factory for additional configurations not shown here.

### Circuit Breaker Configurations

X	Y	Z
(1) 30A, 1P, 120V (1) 20A, 1P, 120V	(1) 50A, 2P, 120/240V (1) 20A, 1P, 120V	(1) 50A, 2P, 120/240V (1) 30A, 1P, 120V (1) 20A, 1P, 120V

Please consult serving utility for their requirements prior to ordering or installing, as specifications and approvals vary by utility, and may require local electrical inspector approval. All installations must be installed by a licensed electrician and must comply with all national and local codes, laws and regulations. Milbank reserves the right to make changes in specifications and features shown without notice or obligation.



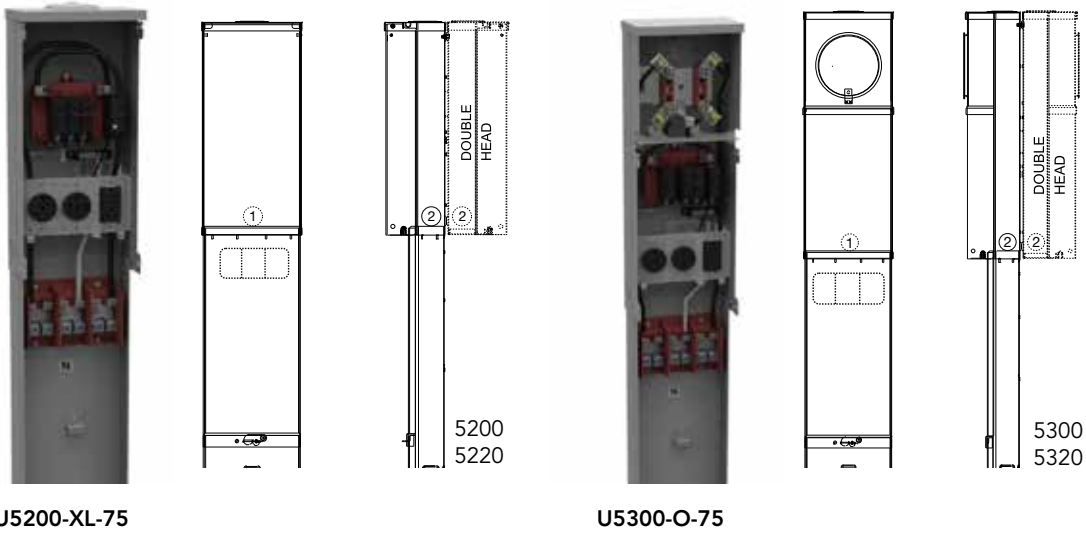

U5200-XL-75

U5300-O-75

### 125 Amp | Power Outlet Pedestals | Direct Burial

Catalog Number	Double Head Catalog Number	Metered/ Unmetered	Receptacle Configuration	Circuit Breaker Configuration	Dimensions			Knockout
					D"	W"	H"	1
U5200-XL	U5220-XL	Unmetered	—	—	5 <sup>5</sup> / <sub>16</sub>	9 <sup>1</sup> / <sub>8</sub>	64 <sup>1</sup> / <sub>2</sub>	1 <sup>1</sup> / <sub>4</sub>
U5200-XL-41	U5220-XL-41	Unmetered	A	X	5 <sup>5</sup> / <sub>16</sub>	9 <sup>1</sup> / <sub>8</sub>	64 <sup>1</sup> / <sub>2</sub>	1 <sup>1</sup> / <sub>4</sub>
U5200-XL-55	U5220-XL-55	Unmetered	B	Y	5 <sup>5</sup> / <sub>16</sub>	9 <sup>1</sup> / <sub>8</sub>	64 <sup>1</sup> / <sub>2</sub>	1 <sup>1</sup> / <sub>4</sub>
U5200-XL-75	U5220-XL-75	Unmetered	C	Z	5 <sup>5</sup> / <sub>16</sub>	9 <sup>1</sup> / <sub>8</sub>	64 <sup>1</sup> / <sub>2</sub>	1 <sup>1</sup> / <sub>4</sub>
U5300-O	U5320-O	Metered	—	—	5 <sup>5</sup> / <sub>16</sub>	9 <sup>1</sup> / <sub>8</sub>	70 <sup>1</sup> / <sub>4</sub>	1 <sup>1</sup> / <sub>4</sub>
U5300-O-41	U5320-O-41	Metered	A	X	5 <sup>5</sup> / <sub>16</sub>	9 <sup>1</sup> / <sub>8</sub>	70 <sup>1</sup> / <sub>4</sub>	1 <sup>1</sup> / <sub>4</sub>
U5300-O-55	U5320-O-55	Metered	B	Y	5 <sup>5</sup> / <sub>16</sub>	9 <sup>1</sup> / <sub>8</sub>	70 <sup>1</sup> / <sub>4</sub>	1 <sup>1</sup> / <sub>4</sub>
U5300-O-75	U5320-O-75	Metered	C	Z	5 <sup>5</sup> / <sub>16</sub>	9 <sup>1</sup> / <sub>8</sub>	70 <sup>1</sup> / <sub>4</sub>	1 <sup>1</sup> / <sub>4</sub>

\*Circuit Breaker Bridge included

#### Receptacle Configurations

A	B	C
(1) TT30R, (1) 5-20R GFI	(1) 14-50R, (1) 5-20R GFI	(1) 14-50R, (1) TT30R, (1) 5-20R GFI

#### Circuit Breaker Configurations

X	Y	Z
(1) 30A, 1P, 120V (1) 20A, 1P, 120V	(1) 50A, 2P, 120/240V (1) 20A, 1P, 120V	(1) 50A, 2P, 120/240V (1) 30A, 1P, 120V (1) 20A, 1P, 120V

**NOTE**  
Contact factory for additional configurations not shown here.  
Pad mount is available - contact factory for information.

\*\*Additional Configurations



Please consult serving utility for their requirements prior to ordering or installing, as specifications and approvals vary by utility, and may require local electrical inspector approval. All installations must be installed by a licensed electrician and must comply with all national and local codes, laws and regulations. Milbank reserves the right to make changes in specifications and features shown without notice or obligation.

# Lever Bypass Multi-Position Sockets

200 Amp | 5 Terminal | Ringless

39

LEVER BYPASS  
MULTI-POSITION  
SOCKETS



U4374-XT-5T9

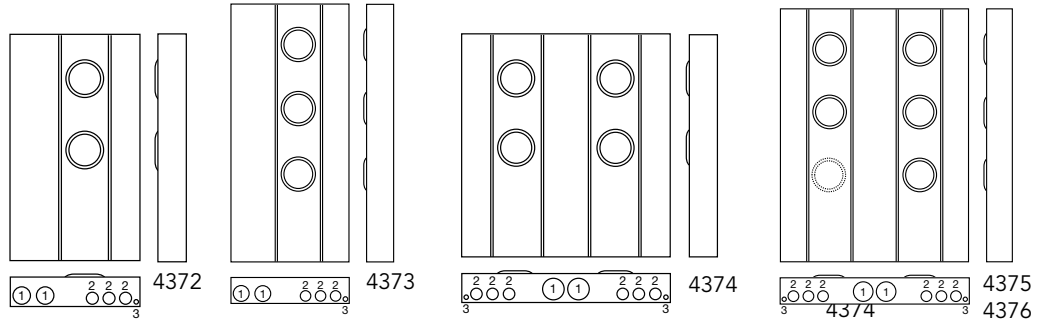

## 200 Amp | 5 Terminal | Lever Bypass | Ringless

Catalog Number	Positions	Main Bus Rating	Line Connector Size	Dimensions			Knockouts		
				D"	W"	H"	1	2	3
U4372-XT-5T9	2	320 Amp	3/8" x 16 Stud*	6	27 3/4	48	3	2	1/4, 1/2
U4373-XT-5T9	3	480 Amp	3/8" x 16 Stud*	6	27 3/4	60	3	2	1/4, 1/2
U4374-XT-5T9	4	640 Amp	3/8" x 16 Stud*	6	45	48	3	2	1/4, 1/2
U4375-XT-5T9	5	640 Amp	3/8" x 16 Stud*	6	45	60	3	2	1/4, 1/2
U4376-XT-5T9	6	640 Amp	3/8" x 16 Stud*	6	45	60	3	2	1/4, 1/2

### Notes

- **\*Connectors:** For line wire connector kits, order separately (see chart above).
- **Breakers:** Units have provision for one double pole main per meter position. Breakers not included. Order as extra (see chart above).
- **Bypass:** Lever supplies clamping action on meter spades and also operates bypass device.
- **Short Circuit Current Rating:** 10K AIC. However, this rating is limited to the lowest interrupting capacity of any circuit breaker installed. Watthour meter not included in short circuit current rating.

### Connector Kits\*

Size	Suffix	Kit Number	Compatible With	Wire Range
Single	-K1	<b>K1539</b>	U2852-56, U2862-66	#6-350
	-K3	<b>K1540</b>	U2854-56, U2864-66	#4-600
Twin	-K2	<b>K1350</b>	U2854-56, U2863-66	#6-350
	-K4	<b>K1541</b>	U2864-66	#2-600

### Breaker Chart

Manufacturer	150-200 Amps	125 Amps or Less
Milbank	WBJ	—
Cutler Hammer	BR, BJ	Quicklag P, BR, HQP
Siemens	QNR	QP
Siemens/Murray	MD	MP
G.E.	Q Line	Q Line
Square D	—	Homeline

Please consult serving utility for their requirements prior to ordering or installing, as specifications and approvals vary by utility, and may require local electrical inspector approval. All installations must be installed by a licensed electrician and must comply with all national and local codes, laws and regulations. Milbank reserves the right to make changes in specifications and features shown without notice or obligation.





**UQFP  
UQFPH**



**UQFP-M  
UQFPH-M**



**UQFB-X1**



**UQFBH**

### 200 Amp Frame | Plug-In | 10,000 AIC & 22,000 AIC | Two-Pole - Common Trip

Amps	10K AIC Plug-In	22K AIC Plug-In	10K AIC Plug-In	22K AIC Plug-In	Wire Range	
					CU	AL
100	UQFP-100	UQFPH-100	UQFP-M-100	UQFPH-M-100	#3-#1	#1-1/0
125	UQFP-125	UQFPH-125	UQFP-M-125	UQFPH-M-125	#3-#1	#1-1/0
150	UQFP-150	UQFPH-150	UQFP-M-150	UQFPH-M-150	1/0-300	2/0-300
175	UQFP-175	UQFPH-175	UQFP-M-175	UQFPH-M-175	1/0-300	2/0-300
200	UQFP-200	UQFPH-200	UQFP-M-200	UQFPH-M-200	1/0-300	2/0-300

### 200 Amp Frame | Bolt-On | 10,000 AIC & 22,000 AIC | Two-Pole - Common Trip

Amps	10K AIC Bolt-On	22K AIC Bolt-On	10K AIC Bolt-On	22K AIC Bolt-On	Wire Range	
					CU	AL
100	UQFB-100	UQFBH-100	UQFB-100-X1	UQFBH-M-100	#3-#1	#1-1/0
125	UQFB-125	UQFBH-125	UQFB-125-X1	UQFBH-M-125	#3-#1	#1-1/0
150	UQFB-150	UQFBH-150	UQFB-150-X1	UQFBH-M-150	1/0-300	2/0-300
175	UQFB-175	UQFBH-175	UQFB-175-X1	UQFBH-M-175	1/0-300	2/0-300
200	UQFB-200	UQFBH-200	UQFB-200-X1	UQFBH-M-200	1/0-300	2/0-300

### Notes

- **UL Listed:** For use with 60°C or 75°C wire.
- **UQFP:** For parallel main circuit breaker applications.
- **UQFP-M:** For series main circuit breaker applications. Split load tab features allow for feed-through capability.
- **UQFB:** (2) 1/0-300 lugs provided on load and line side (cable-in, cable-out).
- **UQFB3:** Three-pole available. Consult factory.
- **UQFB-X:** (2) 1/0-300 lugs provided on load side and (2) line bar bus connections on line side.
- **UQFB-M:** For series main circuit breaker applications. Split load tab features allow for feed-through capability.



Please consult serving utility for their requirements prior to ordering or installing, as specifications and approvals vary by utility, and may require local electrical inspector approval. All installations must be installed by a licensed electrician and must comply with all national and local codes, laws and regulations. Milbank reserves the right to make changes in specifications and features shown without notice or obligation.

# Circuit Breakers

QP (small frame) and QN (large frame) | 120/240 VAC

15–125 Amp Breaker  
Plug-In Type | 1" Per Pole

Amps	Poles	10K AIC Plug-In	22K AIC Plug-In
15	Single	Q115	Q115H
15	Double	Q215	Q215H
20	Single	Q120	Q120H
20	Double	Q220	Q220H
25	Single	Q125	Q125H
25	Double	Q225	Q225H
30	Single	Q130	Q130H
30	Double	Q230	Q230H
35	Single	Q135	Q135H
35	Double	Q235	Q235H
40	Single	Q140	Q140H
40	Double	Q240	Q240H
50	Single	Q150	Q150H
50	Double	Q250	Q250H
60	Single	Q160	Q160H
60	Double	Q260	Q260H
70	Single	Q170	Q170H
70	Double	Q270	Q270H
80	Double	Q280	Q280H
90	Double	Q290	Q290H
100	Double	Q2100	Q2100H
125	Double	Q2125	Q2125H



QN2200H



QN2200RH



WBJ2200



Q250

200 Amp Frame | Plug-In | 10,000 AIC & 22,000 AIC | Two-Pole, Common Trip

Amps	10K AIC Plug-In	22K AIC Plug-In	Handle Location	Wire Range	
				CU	AL
150	QN2150	QN2150H	Left facing	#4-300	#4-300
200	QN2200	QN2200H	Left facing	#4-300	#4-300
150	QN2150R	QN2150RH	Right facing	#4-300	#4-300
200	QN2200R	QN2200RH	Right facing	#4-300	#4-300
150	WBJ2150	—	Centered	#2-300	#2-300
200	WBJ2200	—	Centered	#2-300	#2-300

## Notes

- Load connectors supplied with breakers.
- UL listed for use with 60°C or 75°C wire.
- Wire sizes shown are lug capacity. Consult NEC Article #310 for specific wire sizes.

Please consult serving utility for their requirements prior to ordering or installing, as specifications and approvals vary by utility, and may require local electrical inspector approval. All installations must be installed by a licensed electrician and must comply with all national and local codes, laws and regulations. Milbank reserves the right to make changes in specifications and features shown without notice or obligation.



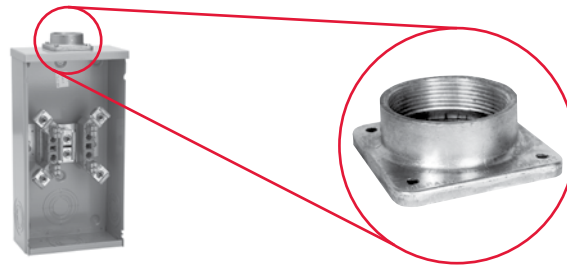
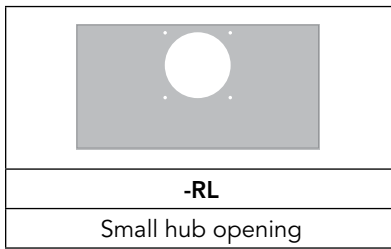

<b>-WL</b>   <b>A7514</b>	<b>-YL</b>   <b>A7515</b>	<b>-ZL</b>   <b>A7516</b>	<b>-DL</b>   <b>A7517</b>	<b>-EL</b>   <b>A7518</b>	<b>-XL</b>   <b>A7551</b>
1" hub	1¼" hub	1½" hub	2" hub	2½" hub	Small closing plate

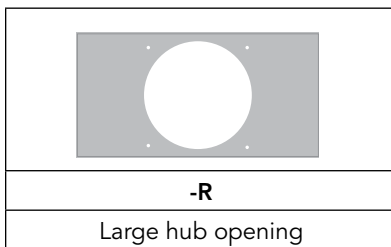

<b>-F</b>   <b>A8110</b>	<b>-G</b>   <b>A8111</b>	<b>-H</b>   <b>A8112</b>	<b>-X</b>   <b>A9064</b>	<b>-RRL</b>   <b>S8324</b>	<b>-RXL</b>   <b>S8324</b>   <b>A7551</b>
3" hub	3½" hub	4" hub	Large closing plate	Large hub opening adapted to small hub opening	Large Hub opening adapted to small closing plate

### Notes

- **Suffix:** Add to catalog number for factory installation of hub.
- **Packaging:** Individually packed units for field installation.
- **Abbreviations:** H.O. (hub opening), C.P. (closing plate).
- Hub Mast rated



Please consult serving utility for their requirements prior to ordering or installing, as specifications and approvals vary by utility, and may require local electrical inspector approval. All installations must be installed by a licensed electrician and must comply with all national and local codes, laws and regulations. Milbank reserves the right to make changes in specifications and features shown without notice or obligation.

# Accessories

## Connector Kits, Closing Kits & Generator Interlock

### Connector Kits — For Use with 3/8"-16 Stud Type Units Only

Single			Twin		
Suffix	Part #	(3 per set) - 1Ø	Suffix	Part #	(3 per set) - 1Ø
K1	K1539	6-350	K2	K1350	6-350
K3	K1540	4-600 or (2) 1/0-250*	K2L	K1350L	6-350 (non rotating)
K3L	K1540L	4-600 or (2) 1/0-250* (non rotating)	K4	K1541	4-600
Suffix	Part #	(4 per set) - 3Ø	Suffix	Part #	(4 per set) - 3Ø
K5	K3082	6-350	K6	K3442	6-350
K7	K3441	4-600 or (2) 1/0-250*	K8	K3083	4-600

\*For (2) 1/0-250, conductors must be of same size.

### Bypass Link



**K8180** (sold in pairs)

### Note

Consult factory for proper connector kits for studded meter sockets.

### Closing Covers

Meter Closing Plate (Ring Type/Ringless)	Metal Closing Plate (For Ringless Sockets)
<b>6003</b> - Grey Plastic	<b>CP-21</b>
<b>6116</b> - Clear Plastic	
<b>6002</b> - Clear Plastic	

### Disconnect Sleeve



**M5-144**

**Do not use with lever bypass sockets**

### Isolated Neutral Kit



**K1047**

### ANSI-61-Grey

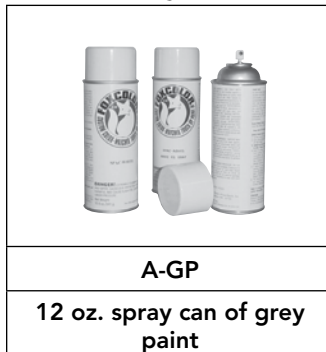

**A-GP**

**12 oz. spray can of grey paint**

### Pole Hanger Kit

850 comes with 4 pole hangers





Catalog Number	Description of pole hanger brackets
<b>850</b>	Two pair (4 pieces) with mounting hardware

Please consult serving utility for their requirements prior to ordering or installing, as specifications and approvals vary by utility, and may require local electrical inspector approval. All installations must be installed by a licensed electrician and must comply with all national and local codes, laws and regulations. Milbank reserves the right to make changes in specifications and features shown without notice or obligation.

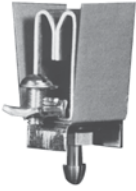

## Fifth Terminals, Tap Connectors & Block Assemblies

### Fifth Terminals

			
<b>5T8K2</b> - 100-200 Amp "Plug-In"	<b>K5T</b> - 200 Amp (Block with Square Hole)	<b>K3865</b> - Heavy Duty Jaw Clamping ( <b>K3866</b> without Neutral Wire)	<b>K3356</b>

### Tap Connectors (3 per set)

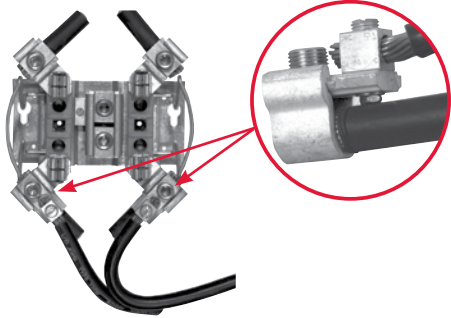
	<p>Replaces the load or line side slide-in nut assembly on Milbank 200 amp sockets. Allows for a 100 amp tap location in addition to the #6-350 kcmil load-side connector. <b>K5022</b> includes safety barrier extensions for applications over 300 VAC. Three lugs per kit.</p>
<b>K4977-INT</b> - Internal Hex	
<b>K4977-EXT</b> - External Hex	
<b>K5022-INT</b> - Internal Hex (set of 4 with barrier) Wire Range #12 - 1/0	

### Triplex Ground

<b>K1190</b> (For factory installed triplex ground, add suffix -TG to catalog number)

### 100 Amp Blocks *(single sockets only)*

<b>BL7474</b> - Block Assembly
<b>Z904486-AO</b> - Slotted Nut Assembly
<b>Z802965-AC</b> - Neutral without Nut
<b>Z901925-AC</b> - Hex Nut Set Screw

### 200 Amp Blocks *(single sockets only)*

<b>K4527</b> - Internal Hex Block Assembly (with meter support)
<b>K4528</b> - External Hex Block Assembly (with meter support)
<b>Z916265-AO</b> - Internal Hex Slide Nut Assembly
<b>Z916264-AO</b> - External Hex Slide Nut Assembly
<b>Z814898-AC</b> - Neutral without Nut



Please consult serving utility for their requirements prior to ordering or installing, as specifications and approvals vary by utility, and may require local electrical inspector approval. All installations must be installed by a licensed electrician and must comply with all national and local codes, laws and regulations. Milbank reserves the right to make changes in specifications and features shown without notice or obligation.



# Replacement Receptacle Plates

For Millennium Series RV Products

**45**  
REPLACEMENT  
RECEPTACLE  
PLATES

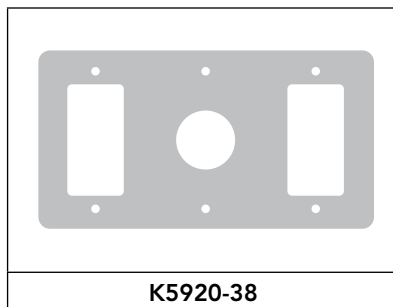
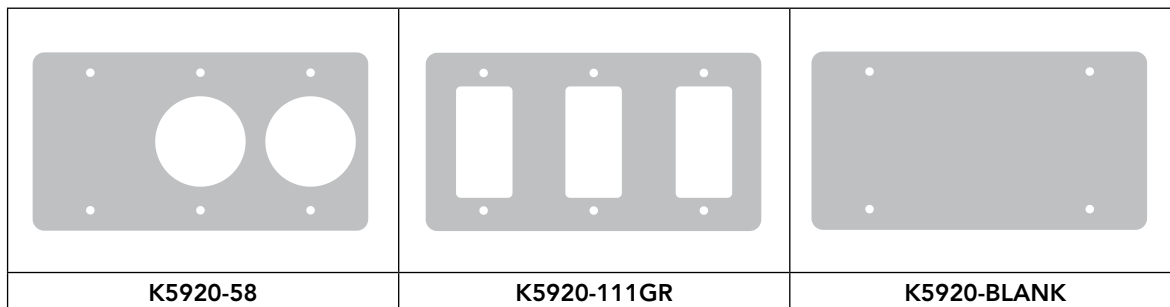
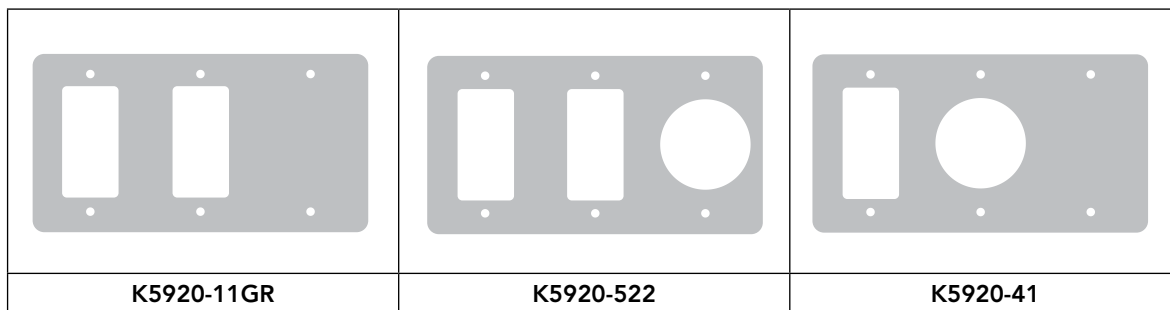
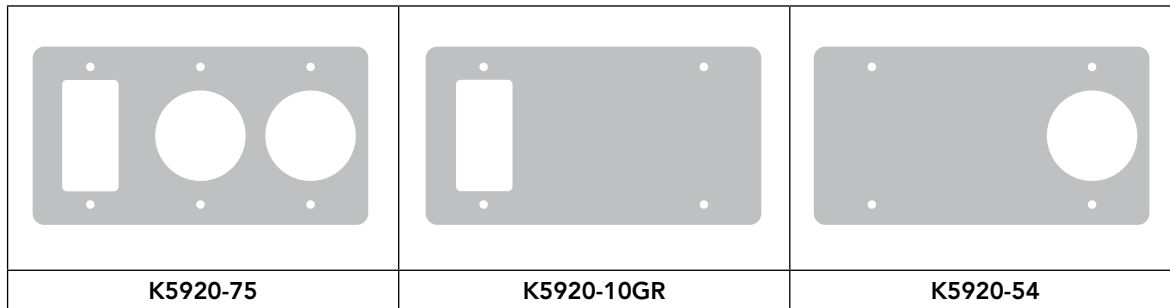

## Notes

- For application details, consult factory.

Please consult serving utility for their requirements prior to ordering or installing, as specifications and approvals vary by utility, and may require local electrical inspector approval. All installations must be installed by a licensed electrician and must comply with all national and local codes, laws and regulations. Milbank reserves the right to make changes in specifications and features shown without notice or obligation.



# Commercial Pedestals

*Attractive | Easy to Install | Secure | Cost-Effective*

**Milbank Commercial Pedestals** are pad-mounted, weather resistant electrical enclosures consisting of a utility pull section with optional meter socket, and a customer section containing distribution and control equipment. Milbank Commercial Pedestals are an attractive, secure, easy to install and cost-effective solution when underground remote site power distribution and control equipment is required, replacing unsightly and inefficient strut and backboard structures.



Strut and backboard



Commercial pedestal

## UL Listed as Industrial Control Equipment (File E113855)

### Standard Features

- Type 3R rain-resistant, vandal-resistant cabinet of polyurethane powder coated steel (aluminum or stainless steel also available)
- UL listed as enclosed industrial control equipment (UL508)
- Isolated lockable and sealable utility metering and lug landing sections
- Lockable customer section for distribution and control equipment with internal deadfront
- Print pocket inside customer section door contains wiring schematics and installation instructions
- Most load centers are UL listed for use with various manufacturers' circuit breakers
- All stainless steel external hardware (screws, bolts, hinges, handles, hasps and sealing screws)

**Note**  
All meter form and bypass options available to meet utility requirements.

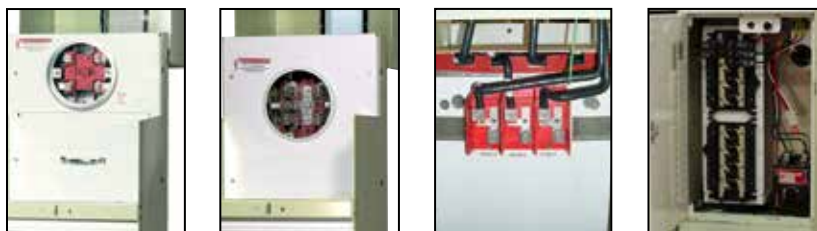

Please consult serving utility for their requirements prior to ordering or installing, as specifications and approvals vary by utility, and may require local electrical inspector approval. All installations must be installed by a licensed electrician and must comply with all national and local codes, laws and regulations. Milbank reserves the right to make changes in specifications and features shown without notice or obligation.

# Commercial Pedestals

Attractive | Easy to Install | Secure | Cost-Effective

**47**  
COMMERCIAL  
PEDESTALS



## Applications

These units are ideal for controlling and metering:

- Traffic signals
- Street lighting
- Power distribution for EV charging stations
- Irrigation and sprinkler systems
- Cell towers and telephone vaults
- Pump stations
- Temporary power for fairgrounds, swap meets, outdoor markets, portable offices, holiday lights, etc.
- Outdoor lighting for athletic fields, tennis and basketball courts, parking lots, landscaping and subdivision entrances, etc.

## Available Factory-Installed Options

- Meter sockets: ring type or ringless, up to 400 amp
- Main and branch breakers or T fuses
- Distribution: copper load centers and panel boards
- Clocks, timers and relays
- Photoelectric cells and controls
- Power receptacles: pin and sleeve, twist lock or straight blade
- Contactors: definite purpose, electrical or mechanically held, IEC and mercury types
- Surge protection and lightning arrestors
- Reserve inlet generator receptacle with interlocked circuit breakers
- Motor starters and relays
- Push button controls
- Thermostat controls, fans and heating strips
- Power blocks and terminal blocks
- Steel, aluminum and plywood backboards
- Transformers
- Interlock devices for circuit breakers
- Available in steel, aluminum (raw painted or anodized) or stainless steel construction with powder coated finish available in eight standard colors or special-ordered RAL colors
- Available for applications up to 400 amp, 120V, 208V, 240V, 277V, 480V - 1Ø or 3Ø

## Accessories



**K3865**  
Fifth terminal kit for use with ringless meter sockets



**CP-ABK5/8**  
Anchor bolt kit (includes four 5/8 - 13 x 18" anchor bolts)



**105J**  
Fifth terminal kit for use with ring type meter sockets



**CP-TC7D**  
7-day time clock kit  
**CP-TC24H**  
24-hour time clock kit  
**CP-TCWIRE**  
Male 4-pin connector and wiring harness for use with time clocks other than above

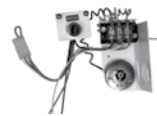

**CP-PE-HOA-3POS**  
HOA switch for field installation



**CP-16PDMNT-CALT**  
16" pedestal mounting base  
**CP-24PDMNT-CALT**  
24" pedestal mounting base (includes mounting hardware)

Please consult serving utility for their requirements prior to ordering or installing, as specifications and approvals vary by utility, and may require local electrical inspector approval. All installations must be installed by a licensed electrician and must comply with all national and local codes, laws and regulations. Milbank reserves the right to make changes in specifications and features shown without notice or obligation.



## CP3B "ML" Series

Main Load Center Series

1Ø3 wire 120/240V or 208Y/120V

Application: remote site service for multiple loads

**Milbank Main Load Center Commercial Pedestals** are designed to handle the vast majority of all requirements in a standard, stocked configuration.

- All units feature a load center with a plug-on, back-fed main breaker.
- Load center has 16 positions for the 100 amp pedestals and 24 circuits for the 200 amp pedestals.
- Both sizes include sub-feed lugs to allow feeding an external panel.

If your application requires turning loads on based on "dusk-to-dawn" requirements, be sure to see the Milbank Switched Load Center Commercial Pedestal products on the following page.

### Features

These units include everything required for remote site service:

- NEMA 3R construction.
- Expandable: load centers allow for future expansion without costly modifications.
- All units feature 200 amp meter socket with optional field installable fifth terminal kit available.
- 22K ampere interrupting capacity (AIC) standard.
- Optional mounting base can be embedded in concrete for fast, easy installation.
- Separate sealable and lockable utility termination section.
- Separate sealable and lockable metering section.
- Separate sealable and lockable customer section with a load center for "always on" loads that include a main circuit breaker, 20 (125 or 200 amp model) or 14 (100 amp model) blank breaker spaces and a circuit directory to document configuration.

**Note**  
All meter form and bypass options available to meet utility requirements.



**Typical Applications**  
Remote site service for multiple loads.

Standard Pedestals	Optional Fifth Terminal Kit	Main CB		Load Center Circuits	Meter Socket Type
		Amp	Spaces		
CP3B51115A22	K3865	100	1,2	16	Ringless socket with lever bypass
CP3B52119A22	K3865	200	1,2,3,4	24	Ringless socket with lever bypass

### Notes

- Chart shows standard, stocked items. Other options and features are available. Contact factory for options, details and availability.



Please consult serving utility for their requirements prior to ordering or installing, as specifications and approvals vary by utility, and may require local electrical inspector approval. All installations must be installed by a licensed electrician and must comply with all national and local codes, laws and regulations. Milbank reserves the right to make changes in specifications and features shown without notice or obligation.

# Commercial Pedestals

Switched Load Center Series | Custom Designs Available

## CP3B "SL" Series

Switched Load Center Series  
1Ø3 wire 120/240V or 208Y/120V

**Note**  
All meter form and bypass options available to meet utility requirements.

**Milbank Switched Load Center Commercial Pedestals** are designed not only to provide power for various loads, but also to switch specific loads on and off under certain conditions. A photoelectric cell is used for these controlled loads, and an optional time clock is also available.

### Features

These units include everything required for remote site service:

- NEMA 3R construction.
- Expandable: load centers allow for future expansion without costly modifications.
- All units feature 200 amp meter socket with optional field installable fifth terminal kit available.
- 22K amp interrupting capacity (AIC) standard.
- Optional mounting base can be embedded in concrete for fast, easy installation.
- Separate sealable and lockable utility termination section.
- Separate sealable and lockable metering section.
- Separate sealable and lockable customer section with a control circuit including PE receptacle, Lexan® window, glare shield, Hand-Off-Auto (HOA) switch, contractor controlling a 16-circuit load center for controlled loads, a pre-mounted DIN rail and pre-wired connector to add an optional "plug-and-play" time clock kit for PE on and TC off operation and a circuit directory to document configuration.
- A load center for "always on" loads that includes a main circuit breaker, a control power circuit breaker, a switched load center main breaker, nine (125 or 200 amp model) or 11 (100 amp model) blank breaker spaces and a circuit directory to document configuration.



**Typical Applications**  
Traffic signals, parking lots, highways & athletic field lighting

Standard Pedestals	Optional Fifth Terminal Kit	Main CB		Contactor Amperage	Meter Socket Type
		Amp	Spaces		
CP3B51110A22SL1	K3865	100	1,3	60	Ringless socket with lever bypass
CP3B52110A22SL1	K3865	200	1,2,3,4	100	Ringless socket with lever bypass

### Notes

- Chart shows standard, stocked items. Other options and features are available. Contact factory for options, details and availability.

Please consult serving utility for their requirements prior to ordering or installing, as specifications and approvals vary by utility, and may require local electrical inspector approval. All installations must be installed by a licensed electrician and must comply with all national and local codes, laws and regulations. Milbank reserves the right to make changes in specifications and features shown without notice or obligation.



# Commercial Pedestals

## CP3B "400" 400 Amp Series



**Milbank 400 Amp Commercial Pedestals** are designed to provide a weather and vandal resistant metered enclosure for various loads and distribution. Each pedestal has been designed to handle a wide range of applications using standard, stocked configurations.

- Choice of a single main breaker or twin service disconnect breakers gives flexibility to the pedestal design.
- Optional distribution with feed-through lugs below the service disconnect breakers allows the pedestal to handle numerous applications.
- Typical applications include remote homes where the metering is best located at the curb side or other remote area. The pedestal can also provide power to secondary residence, on-site business, workshop, irrigation, lighting, security or other secondary load.
- Available in custom colors to match home or landscaping.

### Features

These units include everything required for remote service:

- Type 3R construction
- Main circuit breaker or dual service disconnects
- Expandable: load center units allow for future expansion without costly modifications
- Optional mounting base can be embedded in concrete for fast, easy installation
- Separate sealable and lockable utility termination section with lug termination
- Separate sealable and lockable metering section
- A separate sealable and lockable customer section with a circuit directory and a print pocket to hold all documentation
- Meter socket options include ring type with bypass studs, ringless with heavy duty lever bypass, or K-Type bolt-on

### Typical Applications

Remote site service for residential and commercial job sites.

Standard Pedestals	Optional fifth Terminal Kit	Main CB	Load Center Circuits	Meter Socket Type
CP3B54120B22	K3865	2-200 amp	(2) 12 circuit	Ringless with lever bypass
CP3B5411JB22	K3865	320 amp (400 max)	0	Ringless with lever bypass

### Notes

- Chart shows standard, stocked items. Other options and features are available. Contact factory for options, details and availability.
- Stud utility landing is standard. Lug kits are available from factory.
- Units with load centers have (2) #6-250 sub-feed lugs on each load center. (Each load center is 200 amp rated and UL listed with: Siemens, General Electric and Cutler-Hammer plug-in style circuit breakers.)



Please consult serving utility for their requirements prior to ordering or installing, as specifications and approvals vary by utility, and may require local electrical inspector approval. All installations must be installed by a licensed electrician and must comply with all national and local codes, laws and regulations. Milbank reserves the right to make changes in specifications and features shown without notice or obligation.

# Commercial Pedestals

## CP3B "IR" Irrigation Control Series



**Milbank "IR" Series Irrigation Pedestals** install quickly and simply – often in less than an hour with a single technician – a fraction of the time typically needed for strut farm and other installation set ups. Additionally, the pedestal comes pre-wired, so the technician simply drops in the pre-drilled concrete box pad, fastens the pedestal and runs the wires. Prewired landing lugs are provided in a separate utility side so that there is no more need to wrestle with hard-to-bend wires. Simply run the utility wire up and land on the lugs. With both the motor starter and disconnect in the same enclosure, all the controls are housed in a safe, lockable pedestal that protects against vandalism and energy theft.

### Features

- 3Ø4W, 480Y/277 volt
- One technician can install in under an hour with use of Milbank's pre-drilled box pad
- All units are UL listed and service entrance rated
- Fused disconnect with accessible handle through the deadfront
- HOA and push button start
- Separate accessible utility side with pre-wired landing lugs
- NEMA rated starters (sizes 1-5)
- Soft start units sizes 30HP-150HP
- 30 amp fuse block for pivot pre-wired in the unit
- White powder coated paint finish helps keep components cooler
  - Options include:
    - Hour meter
    - Chemical injection receptacle
    - Multiple injection receptacle
    - Multiple 30 amp fuse blocks possible

### Typical Applications

Power pedestal for irrigation systems or other pump control applications.

Standard Pedestals	Exterior Cabinet	NEMA Rating
CP3B0281UMWIR04	White	4
CP3B0281UMWIR03	White	3
CP3B0181UMWIR02	White	2

### Notes

- Chart shows standard, stocked items. Other options and features are available. Contact factory for options, details and availability.

Please consult serving utility for their requirements prior to ordering or installing, as specifications and approvals vary by utility, and may require local electrical inspector approval. All installations must be installed by a licensed electrician and must comply with all national and local codes, laws and regulations. Milbank reserves the right to make changes in specifications and features shown without notice or obligation.



# Commercial Pedestals

## CP3B "BBS" Battery Backup Series



**Milbank BBS Series Commercial Pedestals** are designed to provide battery backup power for various loads, and to switch specific loads on and off under certain conditions; a photoelectric cell or time clock to control lighting circuits, as an example. Metered and unmetered power distribution options are available. The back-up power pedestal is designed to handle the vast majority of today's back-up power requirements. By using 19" rack design, shelves can be adjusted to accommodate the required batteries and manufactures DC to AC inverters, transfer switches and other related equipment. This design gives the user a wide range of design and configuration options. Complete turnkey, ready to power-up pedestals are offered along with basic units ready to accept batteries and inverters supplied by others.

### Features

- Type 3R construction
- 100 through 320 amp meter socket with the option of either a ring type socket (conforms to EUSERC 308) with or without test/bypass blocks or a heavy duty ringless socket with lever bypass
- Separate sealable utility termination compartment
- An isolated separate customer section with service disconnects, power distribution options and power control
- 19" wide rack in customer compartment for easy layout of equipment
- Battery trays
- Thermostat with cooling fan
- Filtered louvers for heat rise flow through ventilation
- Three point door latch (key or pad lockable)

### Typical Applications

Metered emergency uninterrupted power for traffic intersections, wireless, phone and communications equipment, parking lots, camera and security locations.

### Options

- Manual bypass switch
- Transfer switch for generator power back-up
- Generator inlet receptacles 30 amp through 200 amp
- Pad lockable provision for receptacles
- Police access door
- Metered load center distribution
- Unmetered load center distribution
- Photo electric controls (for street lighting)
- Time clocks
- HOA switches
- Contactors
- GFI duplex receptacles
- Thermostat for heating control
- Heating pads or elements
- Roll out shelves for batteries
- Surge arrestors and lighting arrestors



Please consult serving utility for their requirements prior to ordering or installing, as specifications and approvals vary by utility, and may require local electrical inspector approval. All installations must be installed by a licensed electrician and must comply with all national and local codes, laws and regulations. Milbank reserves the right to make changes in specifications and features shown without notice or obligation.



# Commercial Pedestals

## CP3B "Power Transfer" Series



**Milbank Power Transfer Series Pedestals** provide unmetered AC power, distribution, surge suppression, mechanical interlock and stand-by generator receptacle all in a neat, compact pedestal.

### Features

- 120/240V 1Ø3W through 277/480V 3Ø4W ratings
- Metered or unmetered units
- Choice of EUSERC ring type or ringless meter sockets
- 60 amp through 400 amp ratings
- UL listed Type 3R rated
- Pad lockable, isolated utility compartments
- 20 amp GFI convenience receptacle
- Lockable recessed generator receptacle door
- Utility and generator indicator light options
- All stainless steel hardware
- Galvanized steel, aluminum or stainless steel cabinet options
- Custom designs available



### Typical Applications

Traffic intersections, cell sites, cable TV, pump and lift stations requiring utility power with backup generator power

Please consult serving utility for their requirements prior to ordering or installing, as specifications and approvals vary by utility, and may require local electrical inspector approval. All installations must be installed by a licensed electrician and must comply with all national and local codes, laws and regulations. Milbank reserves the right to make changes in specifications and features shown without notice or obligation.



# Commercial Pedestals

## CP3BB "CT Metered" Series



**Milbank CT Metered Series Commercial Pedestals** are designed to be used where a smaller service package would be a better choice over large 3R rated combination switchboards. These pedestals have amperage ratings of 400 to 800 amp at voltages up through 480 volt three phase.

### Features

- UL listed, freestanding Type 3R service
- A low profile CT pedestal
- All utility equipment is isolated in separated pad lockable and sealable compartments
- Separate customer compartment designed to hold distribution and control equipment
- Dead front customer construction
- Optional mounting base
- Optional construction in steel, aluminum and stainless steel.
- Wide choice of powder paint colors

### Typical Applications

Large homes, pumping and lift stations, motor control, water treatment plants, EV charging stations, commercial buildings, large remote service requirements, commercial and industrial control systems.



Please consult serving utility for their requirements prior to ordering or installing, as specifications and approvals vary by utility, and may require local electrical inspector approval. All installations must be installed by a licensed electrician and must comply with all national and local codes, laws and regulations. Milbank reserves the right to make changes in specifications and features shown without notice or obligation.

# Commercial Pedestals

## CP3A "Slimline" Series



**Milbank Slimline Series Commercial Pedestals** provide a sleeker, smaller footprint, with wireway access on the side of the unit rather than the back, allowing maximum flexibility to place the pedestal in tighter spaces.

### Features

- UL listed as service equipment
- 100 or 200 amp
- Vandal-resistant, secure and attractive design
- Customer compartment with distribution and control equipment with swing dead front door, secured with both a hasp/latch and draw latch outer door
- Utility metering compartment protected with a hinged hood, increasing resistance to meter vandalism
- Small footprint
- Wireway located on left side of pedestal for utility incoming wire, allowing pedestal to be mounted with back very close to a wall (14")
- Available in 12" and 20" widths and 50" and 63" (metered) and 43" (unmetered) heights
- Includes a print pocket for plans and drawings
- 200 amp main available
- Voltage range: 120V–480V
- Compatible with both ringless and ring type meter sockets, 4–7 terminals
- Available in a wide array of colors, including but not limited too all ANSI powder coated paint colors upon request
- Pedestal mounting base option saves time and labor to install on a cement pad—no anchor bolts required
- Powder coated G90 galvanized steel, raw, anodized or powder coated aluminum and stainless steel exterior options

### "Slimline" Series Direct Bury Extension

- No need for concrete
- Bolts directly to unit
- Easy, modular design
- Ships in a smaller package
- Increases project flexibility
- Easier to handle and install
- Utilizes stabilizer feet to prevent leaning over time
- Pedestal and extension can be installed within 45 minutes

### Notes

- 14 guage steel
- Only available for 12" pedestals

### Typical Applications

Roadway lighting and signage, wastewater treatment facilities, parks and landscaping, and any application where physical space is at a premium



Please consult serving utility for their requirements prior to ordering or installing, as specifications and approvals vary by utility, and may require local electrical inspector approval. All installations must be installed by a licensed electrician and must comply with all national and local codes, laws and regulations. Milbank reserves the right to make changes in specifications and features shown without notice or obligation.



## NEMA Commercial Enclosures

Milbank's line of commercial enclosures includes the full gamut of styles and sizes; everything from junction boxes to transformer cabinets, telephone cabinets to wireway.

### Type 1 Enclosures

Milbank's Type 1 enclosures are designed for indoor use to provide a degree of protection to personnel against access to hazardous parts and to provide a degree of protection of the equipment inside the enclosure against ingress of solid foreign objects, such as falling dirt.

### Type 3R Enclosures

Milbank's Type 3R enclosures are designed for either indoor or outdoor use to provide a degree of protection from harmful effects on the equipment due to the ingress of water (rain, sleet, snow) and that will be undamaged by the external formation of ice on the enclosure.

### Wireway

Milbank's wide range of wireway is available in many styles and sizes and its wide range of fittings allows it to smoothly transition to and from competitors' products.

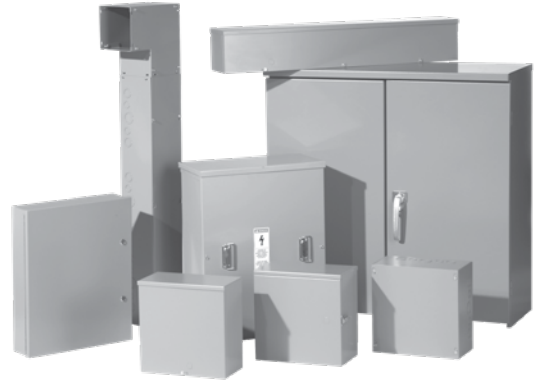

## NEMA Industrial Enclosures

Milbank's line of industrial enclosures include junction boxes, wiring trough, push-button enclosures and modular enclosures. Milbank also excels in special designs; nearly any type, size or color of enclosure you need, we can make!

### Type 12 Enclosures

Enclosures constructed without knockouts for indoor use to provide a degree of protection to personnel against access to hazardous parts, and protect components against falling dirt, circulating dust and lint, and dripping or splashing water.

### Type 4 Enclosures

Enclosures constructed for either indoor or outdoor use to provide a degree of protection to personnel against access to hazardous parts; protect equipment against falling dirt and windblown dust; protect against rain, sleet, snow, splashing water, and hose directed water; and is resistant to damage by the external formation of ice on the enclosure.

### Industrial Enclosure Specials

Milbank specializes in custom enclosure projects, offering an almost limitless amount of styles, options, colors and sizes. Milbank will meet your needs and specifications and deliver a custom enclosure that protects your crucial electric equipment.

### Thermal Management

Protect components housed in enclosures from damage caused by overheating, freezing, humidity and condensation with these thermal management products.



Please consult serving utility for their requirements prior to ordering or installing, as specifications and approvals vary by utility, and may require local electrical inspector approval. All installations must be installed by a licensed electrician and must comply with all national and local codes, laws and regulations. Milbank reserves the right to make changes in specifications and features shown without notice or obligation.

# Watt-hour Meter Forms

Standard Forms | Transformer Rated or Self-Contained

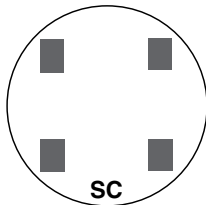

**SC**  
2 and 3-WIRE FORMS  
1S & 2S

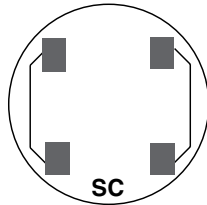

**SC**  
2 and 3-WIRE FORMS  
1S & 2S with BYPASS

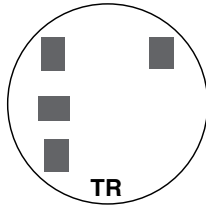

**TR**  
2-WIRE FORM 3S  
5th Term. 9 o'clock

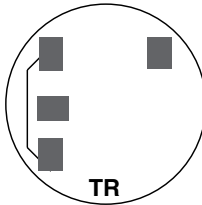

**TR**  
2-WIRE FORM 3S  
with BYPASS

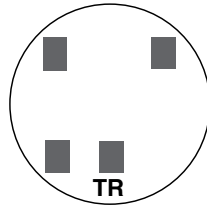

**TR**  
2-WIRE FORM 3S  
5th Term. 6 o'clock

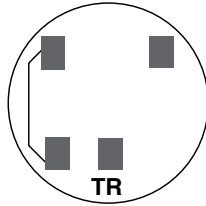

**TR**  
2-WIRE FORM 3S  
with BYPASS

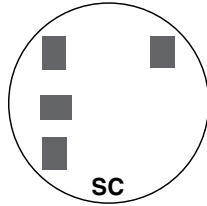

**SC**  
2 ELEMENT  
3-WIRE NETWORK  
FORM 12S 5th  
TERM. 9 o'clock

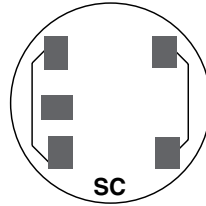

**SC**  
2 ELEMENT 3-WIRE  
NETWORK FORM 12S  
with BYPASS  
5th Term. 9 o'clock

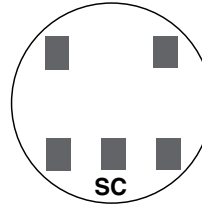

**SC**  
2 ELEMENT  
3-WIRE NETWORK  
FORM 12S 5th  
TERM. 6 o'clock

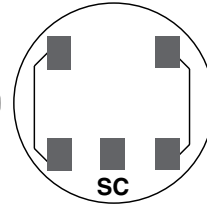

**SC**  
2 ELEMENT 3-WIRE  
NETWORK FORM 12S  
with BYPASS  
5th Term. 6 o'clock

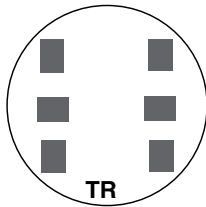

**TR**  
3-WIRE FORM 4S

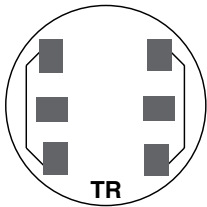

**TR**  
3-WIRE FORM 4S  
WITH BYPASS

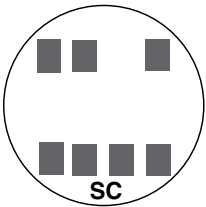

**SC**  
2 or 3 ELEMENT  
3Ø4W Y or  
Y FORM 14S  
FORM 15S  
Y FORM 16S

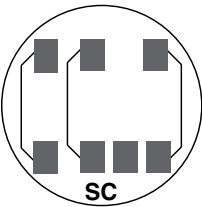

**SC**  
2 or 3 ELEMENT  
3Ø4W Y or  
FORMS 14S & 15S  
with BYPASS

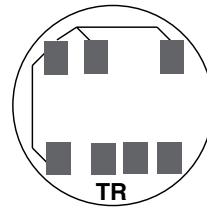

**TR**  
2 ELEMENT  
3Ø4W Y or  
Y FORM 7S  
FORM 24S  
with BYPASS

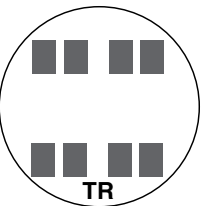

**TR**  
2 ELEMENT  
2Ø3W, 2Ø4W, 3Ø3W  
FORM 5S

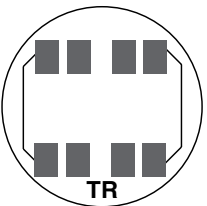

**TR**  
2 ELEMENT Ø3W,  
3Ø4W, 3Ø3W  
FORM 5S with  
BYPASS

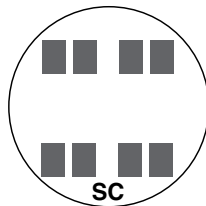

**SC**  
2 ELEMENT  
2Ø3W, 2Ø4W, 3Ø3W  
FORM 13S

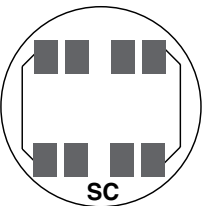

**SC**  
2 or 3 ELEMENT  
2Ø3W, 2Ø4W, 3Ø3W  
FORM 13S with  
BYPASS

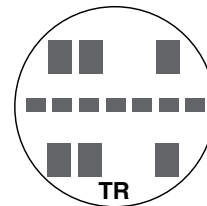

**TR**  
2 or 3 ELEMENT  
3Ø4W Y or  
Y FORM 9S  
FORM 8S

TR = TRANSFORMER RATED  
SC = SELF CONTAINED

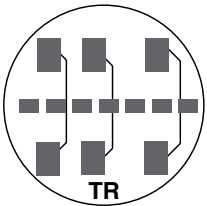

**TR**  
2 or 3 ELEMENT  
3Ø4W Y or  
FORMS 8S & 9S  
FORMS 8S & 9S  
with BYPASS

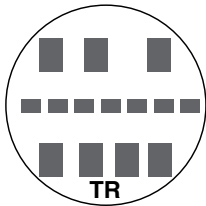

**TR**  
2 ELEMENT  
3Ø4W Y  
FORM 6S

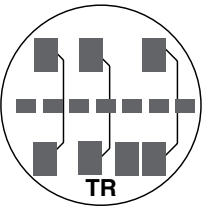

**TR**  
2 ELEMENT  
3Ø4W Y  
FORM 6S  
with BYPASS

Please consult serving utility for their requirements prior to ordering or installing, as specifications and approvals vary by utility, and may require local electrical inspector approval. All installations must be installed by a licensed electrician and must comply with all national and local codes, laws and regulations. Milbank reserves the right to make changes in specifications and features shown without notice or obligation.



**DIAGRAM A**  
1 $\emptyset$ 2W with 1 P.T. & 1 C.T.  
Single Stator Meter(2W1 $\emptyset$ ) - Form 3S  
5T Socket, Test Switch #TS04-0101

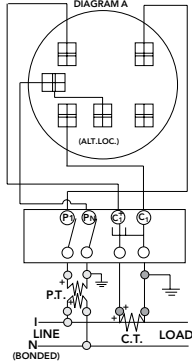

**DIAGRAM B**  
1 $\emptyset$ 3W with 1 C.T.  
Single Stator Meter (2W1 $\emptyset$ ) - Form 3S  
5T Socket, Test Switch #TS04-0101

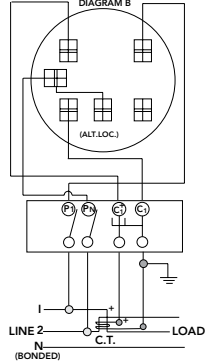

**DIAGRAM C**  
1 $\emptyset$ 3W with 2 C.T.'s  
Single Stator Meter (3W1 $\emptyset$ ) - Form 4S  
6T Socket, Test Switch #TS07-0105

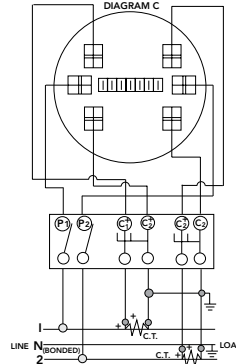

**DIAGRAM D**  
1 $\emptyset$ 3W or 3W Network with 2 C.T.'s  
2 Stator Meter - Form 5S  
8T Socket, Test Switch #TS07-0105

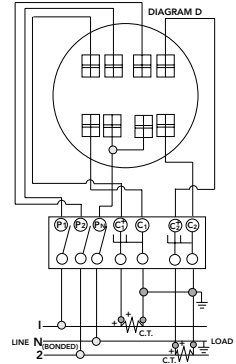

**DIAGRAM E**  
3 $\emptyset$ 3W "A" with 2 P.T.'s & 2 C.T.'s  
2 Stator Meter - Form 5S  
8T Socket, Test Switch #TS07-0105

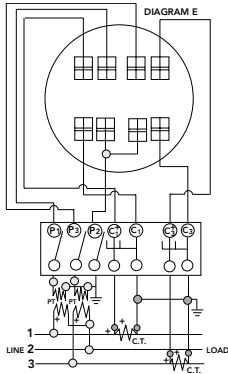

**DIAGRAM F**  
3 $\emptyset$ 3W "A" with 2 C.T.'s  
2 Stator Meter - Form 5S  
8T Socket, Test Switch #TS07-0105

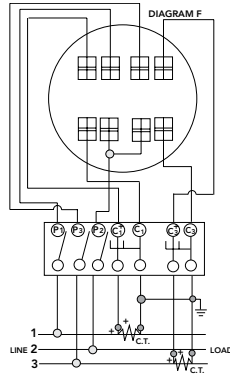

**DIAGRAM G**  
3 $\emptyset$ 4W "Y" with 3 C.T.'s  
2 1/2 Stator Meter - Form 6S  
13T Socket, Test Switch #TS10-0109

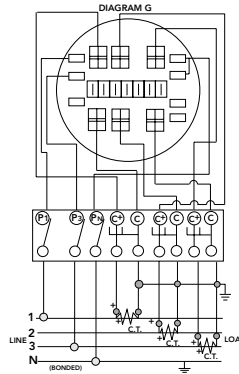

**DIAGRAM H**  
3 $\emptyset$ 4W "Y" with 2 P.T.'s & 3 C.T.'s  
2 1/2 Stator Meter - Form 6S  
13T Socket, Test Switch #TS10-0109

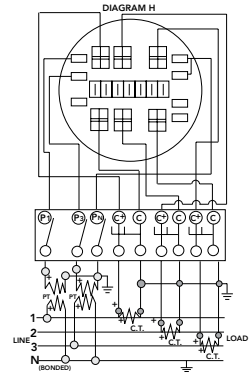

**DIAGRAM I**  
3 $\emptyset$ 4W "Y" or "A" with 3 C.T.'s  
"Y" 3 Stator Meter - Form 9S  
"A" 2 Stator Meter - Form 8S  
13T Socket, Test Switch #TS10-0109

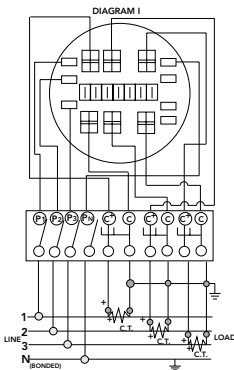

**DIAGRAM J**  
3 $\emptyset$ 4W "Y" with 3 P.T.'s & 3 C.T.'s  
3 Stator Meter - Form 9S  
13T Socket, Test Switch #TS10-0109

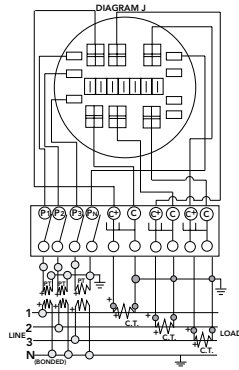

**Prewiring:** If standard factory prewiring is required, refer to wiring diagrams on this page. Determine appropriate diagram and send a copy with order. If custom factory prewiring is required, specify on order. Be sure to include meter socket catalog number, test switch make and catalog number, meter form number and provide a copy of your wiring diagram.



Please consult serving utility for their requirements prior to ordering or installing, as specifications and approvals vary by utility, and may require local electrical inspector approval. All installations must be installed by a licensed electrician and must comply with all national and local codes, laws and regulations. Milbank reserves the right to make changes in specifications and features shown without notice or obligation.

# Conduit, Ampacity & SCCR

## Reference Information

### MAXIMUM NUMBER OF CONDUCTORS IN CONDUIT

Table from 2008 NEC Code Reference: Rigid Metal Conduit

Type	Conductor Size (AWG/kcmil)	Conduit Trade Sizes (Inches)									
		½	¾	1	1¼	1½	2	2½	3	3½	4
THHN, THWN, THWN-2	12	9	16	26	46	62	102	146	225	301	387
	10	6	10	17	29	39	64	92	142	189	244
	8	3	6	9	16	22	37	53	82	109	140
	6	2	4	4	12	16	27	38	59	79	101
	4	1	2	4	7	10	16	23	36	48	62
	3	1	1	3	6	8	14	20	31	41	53
	2	1	1	3	5	7	11	19	26	34	44
	1	1	1	1	4	5	8	12	19	25	35
	1/0	1	1	1	3	4	7	10	16	21	27
	2/0	0	1	1	2	3	6	8	13	18	23
XHH, XHHW, XHHW-2	3/0	0	1	1	1	3	5	7	11	15	19
	4/0	0	1	1	1	2	4	6	9	12	16
	4	1	2	4	7	10	16	24	37	49	63
	2	1	1	3	5	7	12	17	26	35	45
	1/0	1	1	1	3	4	7	10	16	22	28
	2/0	0	1	1	2	3	6	9	13	18	23
	4/0	0	1	1	1	2	4	6	9	12	16
	250	0	0	1	1	1	3	5	7	10	13
	350	0	0	1	1	1	2	3	6	7	10
	500	0	0	0	1	1	1	2	4	5	7
750	0	0	0	0	1	1	1	3	4	5	

This table is for concentric stranded conductors only. For cables with compact conductors refer to NEC. Refer to latest NEC Code or Local Codes for updated requirements.

#### \* ALLOWABLE AMPACITIES OF INSULATED COPPER & \*\* ALUMINUM CONDUCTORS (3W IN CONDUIT) 75°C (167°F)

*CU		AL or **Cu-Clad AL	
A	B	A	C
18	-	-	-
16	-	-	-
14	20†	-	-
12	25†	12	20†
10	35†	10	30†
8	50	8	40
6	65	6	50
4	85	4	65
3	100	3	75
2	115	2	90
1	130	1	100
1/0	150	1/0	120
2/0	175	2/0	135
3/0	200	3/0	155
4/0	230	4/0	180
250	255	250	205
300	285	300	230
350	310	350	250
400	335	400	270
500	380	500	310
600	420	600	340
700	460	700	375
750	475	750	385

A = Size: AWG/MCM  
 \*B = Ampere Rating for Insulation Types:  
**FEPW, RH, RHW, THW, THWN, XHHW, USE, 2W.**  
 \*\*C = Ampere Rating for Insulation Types:  
**RH, RHW, THW, THWN, XHHW, USE**  
 (Per NEC table 310-16)

#### AMPACITY CORRECTION FACTORS

AMBIENT TEMP.°	CORRECTION FACTOR	AMBIENT TEMP.°
21 - 25	1.05	70 - 77
26 - 30	1.00	78 - 86
31 - 35	.94	87 - 95
36 - 40	.88	96 - 104
41 - 45	.82	105 - 113
46 - 50	.75	114 - 122
51 - 55	.67	123 - 131
56 - 60	.58	132 - 140
61 - 65	.33	141 - 158

Overall ampere ratings of U/L listed Milbank multiple position meter sockets are based on 2008 N.E.C. Handbook Article 220-84 and ANSI / UL-414 (except where restricted by line connector size.) These requirements provide for a diversity factor / demand factor being utilized in determining the overall (main bus / lug) rating of a gang socket. All Milbank U/L listed gang sockets meet or exceed these diversity factor/demand factor requirements. Standard overall ampacity ratings for U/L listed and non U/L listed gang sockets are as shown in the chart below. Ampere ratings of meter sockets are based on the meter socket being wired with 75° C insulated wire conductor, sized in accordance with Table 310-16 of the National Electric Code.

#### GANG SOCKET OVERALL AMPACITIES

NO. OF METER POSITIONS	100A / POS. AMPACITY	125A / POS. AMPACITY	150A / POS. AMPACITY	200A / POS. AMPACITY
2	200A	200A	200A	200A #
3	200A	225A	225A	270A
4	200A	250A	270A	360A
5	225A	285A	338A	450A
6	270A	330A	396A	528A

† Unless otherwise permitted elsewhere in the Code, the overcurrent protection for conductor types marked with an obelisk (†) shall not exceed 15 amps for 14 AWG, 20 amps for 12 AWG, and 30 amps for 10 AWG copper; or 15 amps for 12 AWG and 25 amps for 10 AWG aluminum and copper-clad aluminum after any correction factors for ambient temperature and number of conductors have been applied.

# Some constructions are rated at 400 amps overall. Contact your sales representative for more information. Refer to latest NEC Code or Local Codes for updated requirements.

Please consult serving utility for their requirements prior to ordering or installing, as specifications and approvals vary by utility, and may require local electrical inspector approval. All installations must be installed by a licensed electrician and must comply with all national and local codes, laws and regulations. Milbank reserves the right to make changes in specifications and features shown without notice or obligation.



### Important Note

In addition to national and local electrical codes, many utilities have specific requirements for metering equipment. Always consult the serving utility for their specifications and requirements prior to ordering or installing Milbank meter mounting equipment.

### Before Energizing

1. Give equipment a thorough visual examination to determine that:
  - A. No shipping or installation damage exists.
  - B. Proper clearances have been maintained.
  - C. All connections have been made.
  - D. Equipment is clean and dry.
2. Make a thorough examination to:
  - A. Verify tightness of all bolted connections (see table below).
  - B. Manually operate all circuit breakers, switches, relays, etc.
  - C. Check rigidity of all mountings, bus bars and components.
  - D. Use test equipment to check continuity of circuitry and integrity of insulation.
3. All switches and circuit breakers should be in the "off" position.
4. Verify that manual meter bypass (if applicable) is in non-bypass position.
5. Install cover and/or close doors.
6. If installation is not being energized at this time, follow "after-energizing" steps listed below. These steps will secure the installation in case of accidental energization.

### When Energizing

Use caution and follow established safety procedures:

- 1) Wear safety apparel.
- 2) Use safety equipment.
- 3) Take action to prevent injury to yourself and others in the event of failure of the installation.
- 4) Take action to prevent/decrease damage to property in the event of failure of the installation.
- 5) If you are unsure how to safely energize the installation, get someone who is knowledgeable to do it.

### After Energizing

Secure the installation:

- 1) To prevent accidental contact with energized parts, cover all openings with approved filler devices.
- 2) To prevent unauthorized access, secure all covers and/or doors with approved security devices.
- 3) Attach/post information to advise others of potential hazards associated with the installation.

### Recommended Torque for General Applications\*

Nominal Size	Joint Description		Head Type	Torque (Inch Lbs.)
	Screw	Nut		
10	Brass	Brass Nut or Extruded Hole	All	20-25 inch lbs.
10	Steel	Copper or Aluminum Busbar ≤ 1/8"	All	25-30 inch lbs.
10	Steel	Steel Nut or Extruded Hole; CU or AL Busbar > 1/8"	All	30-35 inch lbs.
12	Steel	Aluminum Extruded Hole	All	30-35 inch lbs.
12	Steel	Steel Nut or Extruded Hole	All	40-50 inch lbs.
1/4	Steel	Aluminum Extruded Hole	All	40-50 inch lbs.
1/4	Steel	Steel Nut or Extruded Hole; CU or AL Busbar	All	50-60 inch lbs.
5/16	Steel	Aluminum Extruded Hole	Hex	60-70 inch lbs.
5/16	Steel	Steel Nut or Extruded Hole; CU or AL Busbar	Hex	100-150 inch lbs.
3/8	Steel	Steel Nut	Hex	150-200 inch lbs.
1/2	Steel	Steel Nut	Hex	200-250 inch lbs.

\* Interior labels typically indicate the required torque for wire connectors and studs, and should be referenced first.  
**CU:** Copper  
**AL:** Aluminum



Please consult serving utility for their requirements prior to ordering or installing, as specifications and approvals vary by utility, and may require local electrical inspector approval. All installations must be installed by a licensed electrician and must comply with all national and local codes, laws and regulations. Milbank reserves the right to make changes in specifications and features shown without notice or obligation.



## Materials

### Steel Quality

---

The meter equipment listed in this catalog is made of galvanized steel (AISI\* G90) to afford the best possible weather proofing.  
\*American Iron and Steel Institute.

### Steel Sheet

---

16 gauge, galvanized, sheet: 1 1/4 oz./ sq.ft. class zinc-coated. (AISI G90)  
14 gauge, galvanized, sheet: 1 1/4 oz./ sq.ft. class zinc-coated.

### Aluminum Extrusion

---

Wire-Terminals: Alloy; 6061-T6, Tin-plated for CU/AL wire.  
Bus Bar: Alloy; 6101-O & 6063-O

### Aluminum Sheet

---

3000 series aluminum sheet, H14, or 5052 series aluminum sheet, H32. Where applicable thicknesses range from .064-.125

### Copper Sheet & Bus

---

Electrolytic copper with tin plating in most applications.

### Insulating Materials

---

- In most units, support bases for current-carrying components are molded from fiberglass reinforced high-strength, track resistant, thermoset polyester molding compounds.
- Clear or black safety shields and polarity barriers are molded from high-strength, track resistant, polycarbonate molding compounds.
- Various sheet insulating materials, as appropriate for the application are utilized in the fabrication of flat, formed and punched component parts and barriers.

## Finish

### Process

---

Light gray state-of-the-art electrostatically applied powder paint offers a durable, non-fading finish. For further information concerning the chemical analysis of the weather resistant finish, please contact the factory.

### Metal Fasteners

---

Zinc-coated with a chromate dip.

## Ratings & Compliance

### Ratings & Compliance

---

All Milbank electrical enclosures in this catalog are rated "Type 3R Enclosure" unless specified otherwise on the product's page. All enclosures with a UL designation are constructed per the appropriate UL Standard and may be installed per the National Electric Code. UL procedure files associated with the UL Standards are listed as follows: Meter Sockets (UL 414, File E30202), Test Switches (UL 414, File E62531), Power Outlets (UL 231, File E90945), Panelboards (UL 67, File E32628) and Pullout Switches (UL 1429, File E133062). Additional standards are utilized as applicable: Meter Sockets (ANSI C12.7), Test Switches (ANSI C12.9) and Panelboards (NEMA PB-1).

Please consult serving utility for their requirements prior to ordering or installing, as specifications and approvals vary by utility, and may require local electrical inspector approval. All installations must be installed by a licensed electrician and must comply with all national and local codes, laws and regulations. Milbank reserves the right to make changes in specifications and features shown without notice or obligation.



# Utility Approval List

Catalog Number	AEP	First Energy	DP&L
U7487-RL-TG-KK		X	X
U7487-RL-TG-KK-BLG	X		
U7021-RL-TG-KK		X	X
U7021-RL-TG-KK-BLG	x		
U7040-RL-TG-KK		X	
U7040-RL-TG-KK-BLG	X		
U7040-XL-TG-KK		X	
U1980-O-KK		X	X
U1980-O-KK-BLG	X		
U9551-RRL		X	X
U9701-RRL		X	
U9701-RRL-BLG	X		
U1079-RRL-K3		X	X
U4905-X		X	
U4905-X-BLG	X		
U1129-O-K3L-K2L		X	X
U5161-X-K3L-K2L-BLG	X		
U1797-O-K3L-K2L		X	
U1797-O-K3L-K2L-BLG	X		
U2594-X		X	
U2594-X-K7-K6-BLG	X		
U2594-X-BLG	X		
U3989-XL		X	
U5844-PXL-200-KK		X	X
U5844-PXL-200-KK-BLG	X		
USE-22-200-MB		X	
U5168-XTL-100-KK		X	
U5168-XTL-100-KK-BLG	X		
U5168-XTL-150-KK		X	
U5168-XTL-150-KK-BLG	X		
U5168-XTL-200-KK		X	X
U5168-XTL-200-KK-BLG	X		
U5268-XTL-150-KK		X	
U5268-XTL-200-KK		X	
U5268-XTL-200-KK-BLG	X		
U5871-XL-200		X	
U5890-X-2/200-BL	X	X	
U5890-X-2/200-BLG	X	X	
U5891-X-2/200-MLK-BL	X	X	
U1232-RRL-KK-K1		X	
U1233-RRL-KK-K1		X	
U1234-RXL-KK-K1		X	
U1252-RRL-KK-K1-SLVG		X	
U1252-RRL-KK-K1-BLG-SLVG	X		

Catalog Number	AEP	First Energy	DP&L
U1253-RRL-KK-K1-SLVG		X	
U1253-RRL-KK-K1-BLG-SLVG	X		
U1254-RXL-KK-K1-SLVG		X	
U1254-RXL-KK-K1-BLG-SLVG	X		
U1255-RXL-KK-K1-SLVG		X	
U1255-RXL-KK-K1-BLG-SLVG	X		
U1256-RXL-KK-K1-SLVG		X	
U1256-RXL-KK-K1-BLG-SLVG	X		
U2872-XT		X	
U2873-XT		X	
U2874-XT		X	
U2875-XT		X	
U2876-XT		X	
U2732-XT		X	
U2733-XT		X	
U2734-XT		X	
U2735-XT		X	
U2736-XT		X	
U2852-X	X	X	
U2853-X	X	X	
U2854-X	X	X	
U2855-X	X	X	
U2856-X	X	X	
U2862-X	X	X	
U2863-X	X	X	
U2864-X	X	X	
U2865-X	X	X	
U2866-X	X	X	
U5902-X-KK-BLG	X	X	
U5903-X-KK-BLG	X	X	
U5904-X-KK-BLG	X	X	
U5905-X-KK-BLG	X	X	
U5906-X-KK-BLG	X	X	
U5882-X-KK-BLG	X	X	
U5883-X-KK-BLG	X	X	
U5884-X-KK-BLG	X	X	
U5885-X-KK-BLG	X	X	
U5886-X-KK-BLG	X	X	
243210-CTC3R			X
363612-LC3R-SP-WB	X	X	
484812-CT3R-WB	X	X	
U5990-O	X	X	



Please consult serving utility for their requirements prior to ordering or installing, as specifications and approvals vary by utility, and may require local electrical inspector approval. All installations must be installed by a licensed electrician and must comply with all national and local codes, laws and regulations. Milbank reserves the right to make changes in specifications and features shown without notice or obligation.

850.....	43	U1129-O-K3L-K2L.....	11	U4375-XT-5T9.....	39
6002.....	43	U1232-RRL-KK-K1.....	20	U4376-XT-5T9.....	39
6003.....	43	U1233-RRL-KK-K1.....	20	U4408-O.....	34
6116.....	43	U1234-RXL-KK-K1.....	20	U4410-O.....	34
243210-CTC3R.....	34	U1252-RRL-KK-K1-BLG-SLVG.....	21	U4490-XL.....	31
304410-CTC3R.....	34	U1252-RRL-KK-K1-SLVG.....	21	U4492-XL.....	31
363612-LC3R-SP-WB.....	34	U1253-RRL-KK-K1-BLG-SLVG.....	21	U4493-XL.....	31
484812-CT3R-WB.....	34	U1253-RRL-KK-K1-SLVG.....	21	U4532-XL.....	9
5T8K2.....	44	U1254-RXL-KK-K1-BLG-SLVG.....	21	U4881-O-50GB.....	8
A7514.....	42	U1254-RXL-KK-K1-SLVG.....	21	U4881-O-60GB.....	8
A7515.....	42	U1255-RXL-KK-K1-BLG-SLVG.....	21	U4905-X.....	11
A7516.....	42	U1255-RXL-KK-K1-SLVG.....	21	U4905-X-BLG.....	11
A7517.....	42	U1256-RXL-KK-K1-BLG-SLVG.....	21	U4908-O-11GR.....	36
A7518.....	42	U1256-RXL-KK-K1-SLVG.....	21	U5000-XL.....	37
A7551.....	42	U1797-O-K3L-K2L.....	11	U5000-XL-41.....	37
A7551.....	42	U1797-O-K3L-K2L-BLG.....	11	U5000-XL-55.....	37
A8110.....	42	U1980-O-KK.....	9	U5000-XL-75.....	37
A8111.....	42	U1980-O-KK-BLG.....	9	U5059-X-2/200-K3L.....	17
A8112.....	42	U2120-X-K7.....	12	U5059-X-K3L.....	17
A9064.....	42	U2594-X.....	12	U5100-XL.....	37
A-GP.....	43	U2594-X-BLG.....	12	U5100-XL-41.....	37
BL7474.....	44	U2594-X-K7-K6-BLG.....	12	U5100-XL-55.....	37
CP-21.....	43	U2732-XT.....	24	U5100-XL-75.....	37
K1047.....	43	U2733-XT.....	24	U5101-XL-11GR.....	36
K1190.....	44	U2734-XT.....	24	U5136-O.....	35
K1350.....	43	U2735-XT.....	24	U5136-O-100S.....	35
K1350L.....	43	U2736-XT.....	24	U5136-O-200S.....	35
K1539.....	43	U2852-X.....	25	U5137-O-200S.....	35
K1540.....	43	U2853-X.....	25	U5161-X-K3L-K2L-BLG.....	11
K1540L.....	43	U2854-X.....	25	U5168-XTL-100-KK.....	16
K1541.....	43	U2855-X.....	25	U5168-XTL-100-KK-BLG.....	16
K3082.....	43	U2856-X.....	25	U5168-XTL-150-KK.....	16
K3083.....	43	U2862-X.....	25	U5168-XTL-150-KK-BLG.....	16
K3356.....	44	U2863-X.....	25	U5168-XTL-200-KK.....	16
K3441.....	43	U2864-X.....	25	U5168-XTL-200-KK-BLG.....	16
K3442.....	43	U2865-X.....	25	U5200-XL.....	38
K3865.....	44	U2866-X.....	25	U5200-XL-41.....	38
K4527.....	44	U2872-XT.....	23	U5200-XL-55.....	38
K4528.....	44	U2873-XT.....	23	U5200-XL-75.....	38
K4977-EXT.....	44	U2874-XT.....	23	U5268-XTL-150-KK.....	16
K4977-INT.....	44	U2875-XT.....	23	U5268-XTL-200-KK.....	16
K5022-INT.....	44	U2876-XT.....	23	U5268-XTL-200-KK-BLG.....	16
K5T.....	44	U3278-RL.....	10	U5300-O.....	38
M5-144.....	43	U3802.....	6	U5300-O-41.....	38
-R.....	42	U3812.....	6	U5300-O-55.....	38
-RL.....	42	U3822-20GWR.....	7	U5300-O-75.....	38
S4019-O.....	34	U3832.....	6	U5750-RXL-200-BL.....	15
S4020-O.....	34	U3862.....	6	U5764-X-200-CB.....	19
S4399-O.....	34	U3989-XL.....	14	U5765-X-200-CB.....	19
S4400-O.....	34	U4363-X-QG-K3-K2.....	11	U5767-X-200-CB.....	19
S8324.....	42	U4372-XT-5T9.....	39	U5784-O-200-CB.....	19
S8324.....	42	U4373-XT-5T9.....	39	U5787-O-200-CB.....	19
U1079-RRL-K3.....	11	U4374-XT-5T9.....	39	U5796-X-400-CB.....	19

Please consult serving utility for their requirements prior to ordering or installing, as specifications and approvals vary by utility, and may require local electrical inspector approval. All installations must be installed by a licensed electrician and must comply with all national and local codes, laws and regulations. Milbank reserves the right to make changes in specifications and features shown without notice or obligation.



U5797-O-400-CB.....	19	UC7636-RL.....	30
U5799-O-400-CB.....	19	UQFB-100.....	40
U5844-PXL-200-KK.....	14	UQFB-100-X1.....	40
U5844-PXL-200-KK-BLG.....	14	UQFB-125.....	40
U5871-XL-200.....	15	UQFB-125-X1.....	40
U5882-X-KK-BLG.....	27	UQFB-150.....	40
U5883-X-KK-BLG.....	27	UQFB-150-X1.....	40
U5884-X-KK-BLG.....	27	UQFB-175.....	40
U5885-X-KK-BLG.....	27	UQFB-175-X1.....	40
U5886-X-KK-BLG.....	27	UQFB-200.....	40
U5890-X-2/200-BL.....	17	UQFB-200-X1.....	40
U5890-X-2/200-BLG.....	17	UQFBH-100.....	40
U5891-X-2/200-MLK-BL.....	17	UQFBH-125.....	40
U5902-X-KK-BLG.....	27	UQFBH-150.....	40
U5903-X-KK-BLG.....	27	UQFBH-175.....	40
U5904-X-KK-BLG.....	27	UQFBH-200.....	40
U5905-X-KK-BLG.....	27	UQFBH-M-100.....	40
U5906-X-KK-BLG.....	27	UQFBH-M-125.....	40
U5971-XL-100.....	13	UQFBH-M-150.....	40
U5971-XL-150.....	13	UQFBH-M-175.....	40
U5971-XL-200.....	13	UQFBH-M-200.....	40
U5990-O.....	34	UQFP-100.....	40
U6115-X-2/200-K7L.....	17	UQFP-125.....	40
U6220-O-100-KK-10GR.....	35	UQFP-150.....	40
U6220-O-200-KK-10GR.....	35	UQFP-175.....	40
U6227-x-400-k3.....	18	UQFP-200.....	40
U6228-x-400-K3.....	18	UQFPH-100.....	40
U6229-X-400-K7.....	18	UQFPH-125.....	40
U6230-X-400-K7.....	18	UQFPH-150.....	40
U7021-RL-TG-KK.....	9	UQFPH-175.....	40
U7021-RL-TG-KK-BLG.....	9	UQFPH-200.....	40
U7040-RL-TG-KK.....	9	UQFPH-M-100.....	40
U7040-RL-TG-KK-BLG.....	9	UQFPH-M-125.....	40
U7040-XL-TG-KK.....	9	UQFPH-M-150.....	40
U7487-RL-TG-KK.....	9	UQFPH-M-175.....	40
U7487-RL-TG-KK-BLG.....	9	UQFPH-M-200.....	40
U9551-RRL.....	10	UQFP-M-100.....	40
U9701-RRL.....	10	UQFP-M-125.....	40
U9701-RRL-BLG.....	10	UQFP-M-150.....	40
UC1299-RL.....	29	UQFP-M-175.....	40
UC1300-RL.....	29	UQFP-M-200.....	40
UC7235-RL.....	29	USE-22-200-MB.....	13
UC7237-XL.....	29	Z802965-AC.....	44
UC7444-RL.....	30	Z814898-AC.....	44
UC7445-RL.....	30	Z901925-AC.....	44
UC7445-RL-641.....	30	Z904486-AO.....	44
UC7445-WL.....	30	Z916264-AO.....	44
UC7448-RL.....	30	Z916265-AO.....	44
UC7449-RL.....	30		
UC7460-RL.....	30		
UC7461-RL.....	30		
UC7478-RL.....	30		
UC7532-RL.....	30		



Please consult serving utility for their requirements prior to ordering or installing, as specifications and approvals vary by utility, and may require local electrical inspector approval. All installations must be installed by a licensed electrician and must comply with all national and local codes, laws and regulations. Milbank reserves the right to make changes in specifications and features shown without notice or obligation.







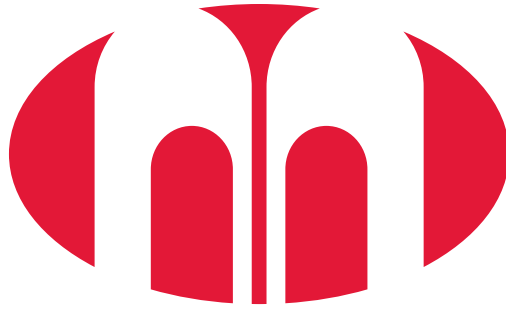

# MILBANK<sup>®</sup>

ENERGY AT WORK

