

Plug

Connector

- 60 Amp 600VAC/250VDC; 50-400 Hertz NEMA 3, 4, 4X<sup>①</sup>
- **PLUGS ONLY**<sup>②</sup>:  
 Class I, Div. 1 & 2, Groups B,C,D; NEMA 7 B,C,D  
 Class I, Zones 1 & 2, IIB+H<sub>2</sub>, IIA  
 Class II, Div. 1 & 2, Groups F & G; NEMA 9 F,G; Class III

**Wire Range**

Regular Stranding: #6 - #4

Extra flex: #6 - #4

UL File No. E10757    SF Certified File No. LR111846

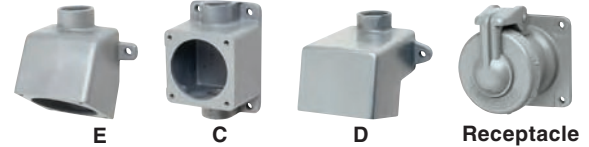

E

C

D

Receptacle

**FEATURES-SPECIFICATIONS**

60 AMP PLUGS & CONNECTORS				
GROUND STYLE	CIRCUIT	GROMMET RANGE	CATALOG NUMBER	
			PLUG	CONNECTOR
Style I	2W2P	.65 - 1.50 IN	VP6275	VPR6255
	3W3P	.65 - 1.50 IN	VP6375	VPR6355
	4W4P	.65 - 1.50 IN	VP6475	VPR6455
Style II	2W3P	.65 - 1.50 IN	VP6385	VPR6365
	3W4P	.65 - 1.50 IN	VP6485	VPR6465

MODIFICATIONS*	
CATALOG NUMBER	DESCRIPTION
S39	Reverse service for receptacles, plugs & connectors
S37	Polarization for receptacles, plugs & connectors

\*See page PR5 for more information on these options.

60 AMP RECEPTACLES & BACK BOXES					
GROUND STYLE	CIRCUIT	CATALOG NUMBER			
		E <sup>③</sup> TYPE	C <sup>③</sup> TYPE	D <sup>③</sup> TYPE	RECEPTACLE ONLY
Style I	2W2P	VR621E4	VR621C4	VR621D4	VR621
	3W3P	VR631E4	VR631C4	VR631D4	VR631
	4W4P	VR641E4	VR641C4	VR641D4	VR641
Style II	2W3P	VR632E4	VR632C4	VR632D4	VR632
	3W4P	VR642E4	VR642C4	VR642D4	VR642
Splice box only <sup>③</sup>		VRE46	VRC46	VRD46	-

<sup>③</sup> 60 Amp Back Boxes are available in 1", 1-1/4" and 1-1/2" conduit sizes. Size listed above is 1-1/4". For other available sizes, change the BOLD "4" in either the assembly or box only number as follows: **3**=1", **4**=1-1/4", **5**=1-1/2". Assembly catalog numbers are listed for ease of ordering or specification and devices are shipped as components. Note: 60 Amp receptacles also fit 100 Amp mounting boxes – see Note<sup>④</sup> on 100 Amp page PR8.

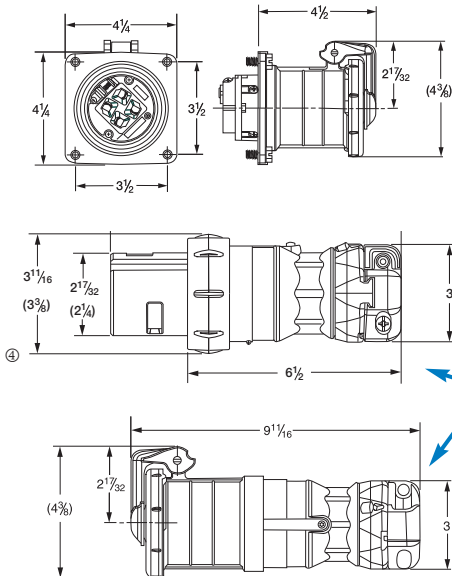

Receptacle

Plug

Connector

VersaRange® clamps provide a firm fit for one plug (or connector) over a wide range of cable diameters (competitors often need two – requiring additional sizing decisions).

① Components are interchangeable & UL classified with other UL1686 configured devices (when installed in accordance with instructions furnished with device). Assemblies containing components from other manufacturers would have the NEMA type rating of the lowest rated device.

② Plugs are hazardous suitable when mated with properly rated receptacles configured to use UL1686 type plugs, such as VersaMate VSQ/VBQ.

④ Dimensions in ( ) are 3 pole devices; balance are 4 pole.

**Back Box Dimensions**

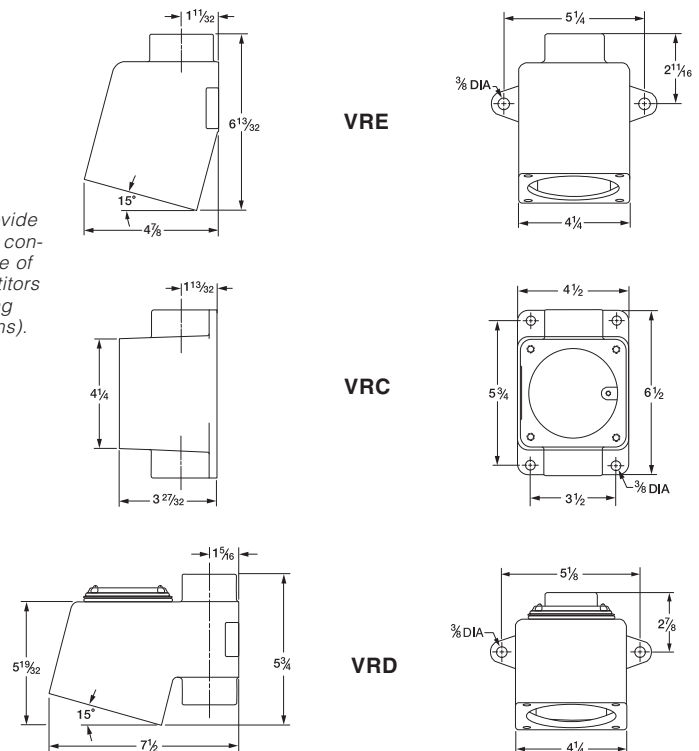

VRE

VRC

VRD

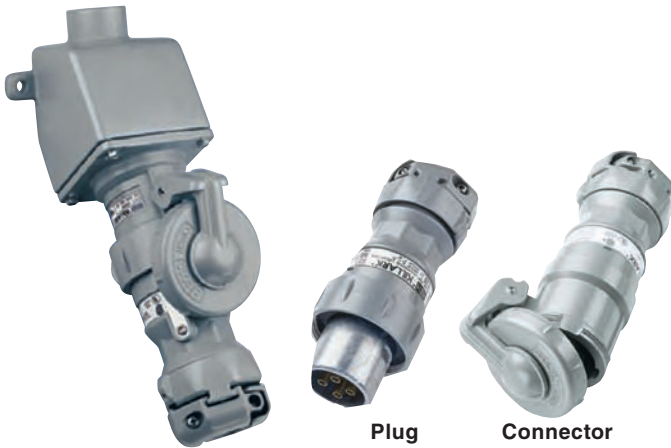

Plug

Connector

- 60 Amp 600VAC/250VDC; 50-400 Hertz NEMA 3, 4, 4X<sup>①</sup>
- **PLUGS ONLY<sup>②</sup>**:  
 Class I, Div. 1 & 2, Groups B,C,D; NEMA 7 B,C,D  
 Class I, Zones 1 & 2, IIB+H<sub>2</sub>, IIA  
 Class II, Div. 1 & 2, Groups F & G; NEMA 9 F,G; Class III

**Wire Range**

Regular Stranding: #6 - #4

Extra flex: #6 - #4

File No. E10757 Certified File No. LR111846

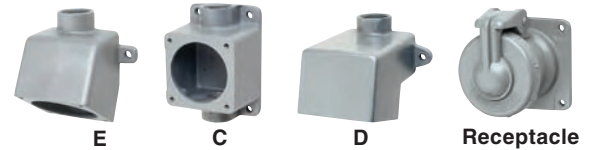

E

C

D

Receptacle

**FEATURES-SPECIFICATIONS**

60 AMP PLUGS & CONNECTORS				
GROUND STYLE	CIRCUIT	GROMMET RANGE	CATALOG NUMBER	
			PLUG	CONNECTOR
Style I	2W2P	.65 - 1.50 IN	VP6275	VPR6255
	3W3P	.65 - 1.50 IN	VP6375	VPR6355
	4W4P	.65 - 1.50 IN	VP6475	VPR6455
Style II	2W3P	.65 - 1.50 IN	VP6385	VPR6365
	3W4P	.65 - 1.50 IN	VP6485	VPR6465

MODIFICATIONS*	
CATALOG NUMBER	DESCRIPTION
S39	Reverse service for receptacles, plugs & connectors
S37	Polarization for receptacles, plugs & connectors

\*See page PR5 for more information on these options.

60 AMP RECEPTACLES & BACK BOXES					
GROUND STYLE	CIRCUIT	CATALOG NUMBER			
		E <sup>③</sup> TYPE	C <sup>③</sup> TYPE	D <sup>③</sup> TYPE	RECEPTACLE ONLY
Style I	2W2P	VR621E4	VR621C4	VR621D4	VR621
	3W3P	VR631E4	VR631C4	VR631D4	VR631
	4W4P	VR641E4	VR641C4	VR641D4	VR641
Style II	2W3P	VR632E4	VR632C4	VR632D4	VR632
	3W4P	VR642E4	VR642C4	VR642D4	VR642
Splice box only <sup>③</sup>		VRE46	VRC46	VRD46	-

<sup>③</sup> 60 Amp Back Boxes are available in 1", 1-1/4" and 1-1/2" conduit sizes. Size listed above is 1-1/4". For other available sizes, change the BOLD "4" in either the assembly or box only number as follows: **3**=1", **4**=1-1/4", **5**=1-1/2". Assembly catalog numbers are listed for ease of ordering or specification and devices are shipped as components. Note: 60 Amp receptacles also fit 100 Amp mounting boxes – see Note<sup>④</sup> on 100 Amp page PR8.

**PR**

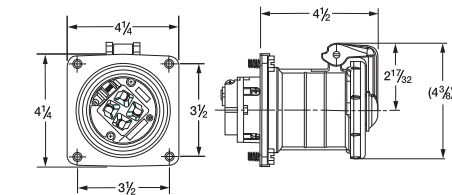

Receptacle

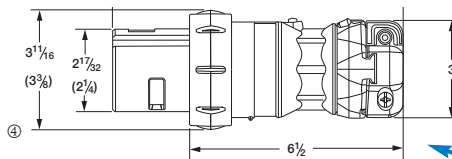

Plug

VersaRange<sup>®</sup> clamps provide a firm fit for one plug (or connector) over a wide range of cable diameters (competitors often need two – requiring additional sizing decisions).

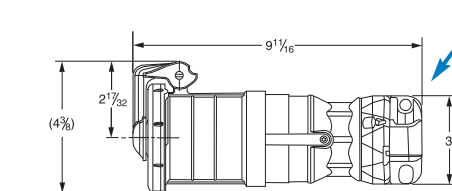

Connector

<sup>①</sup> Components are interchangeable & UL classified with other UL1686 configured devices (when installed in accordance with instructions furnished with device). Assemblies containing components from other manufacturers would have the NEMA type rating of the lowest rated device.

<sup>②</sup> Plugs are hazardous suitable when mated with properly rated receptacles configured to use UL1686 type plugs, such as VersaMate VSQ/VBQ.

<sup>④</sup> Dimensions in ( ) are 3 pole devices; balance are 4 pole.

**Back Box Dimensions**

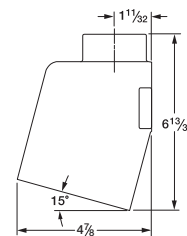

VRE

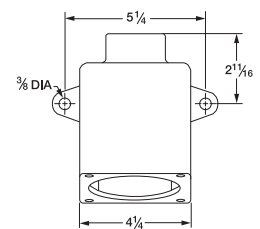

VRC

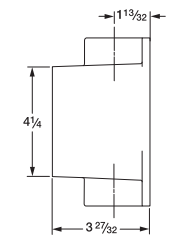

VRD

