

2

1

NOTES:

- 1. MATERIAL: ABS
- 2. ACCEPTS KEYSTONE STYLE INSERT
- 3. APPLICATIONS: DATA, VIDEO
- 4. UL LISTED
- 5. COLORS AVAILABLE: IVORY, BROWN, BLACK, ALMOND, LIGHT ALMOND ,WHITE
- 6. WHITE BULK PACK AVAILABLE
- 7. INSTALLATION HARDWARE INCLUDED

B

B

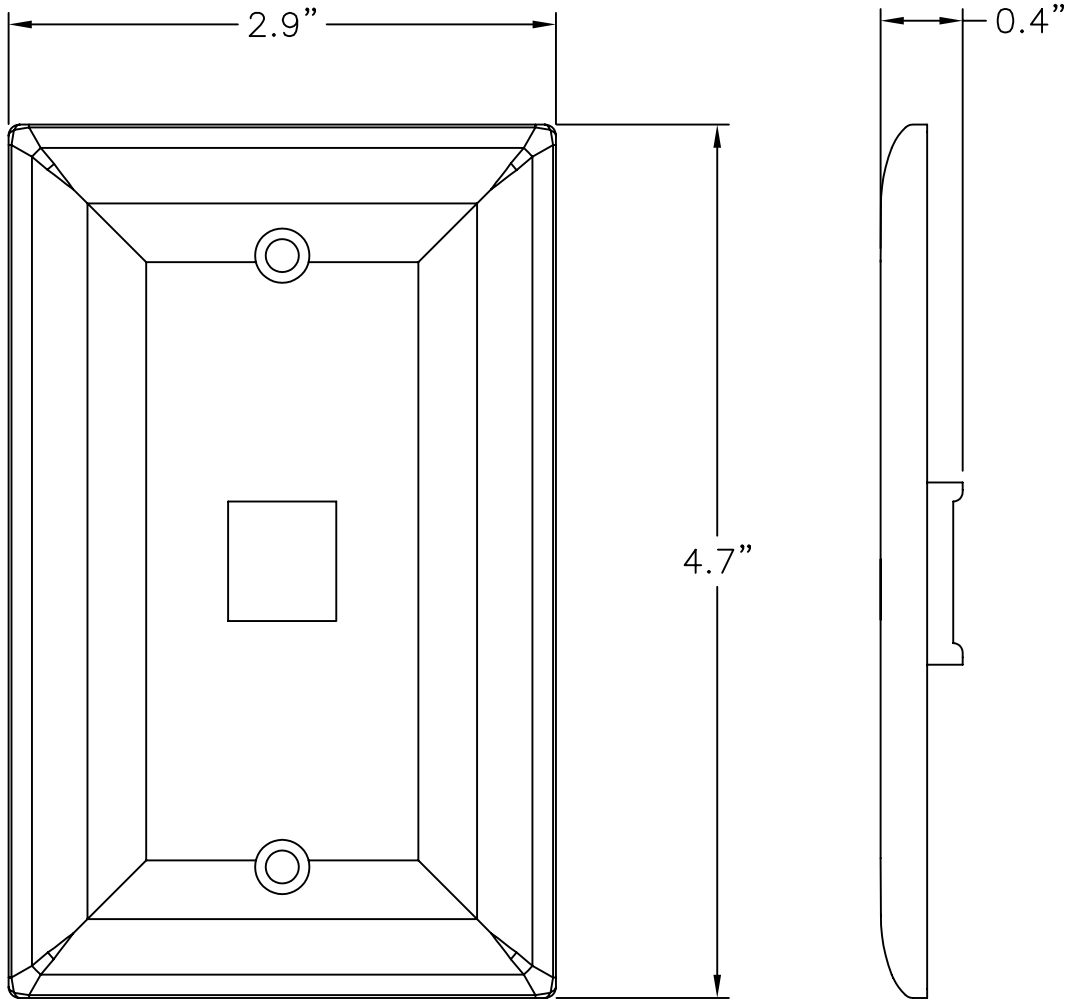

A

A

PROPRIETARY AND CONFIDENTIAL  
 THE INFORMATION CONTAINED  
 IN THIS DRAWING IS THE SOLE  
 PROPERTY OF On-Q/LEGRAND.  
 ANY REPRODUCTION IN PART OR  
 AS A WHOLE WITHOUT THE WRITTEN  
 PERMISSION OF On-Q/LEGRAND  
 IS PROHIBITED. DRAWING IS SUBJECT  
 TO CHANGE WITHOUT NOTICE.

**on·Q**

**legrand**

P.O. Box 60907  
 Middletown, PA 17106-0907  
 1-800-321-2343

TITLE:

**SINGLE GANG WALL PLATE  
 1 PORT**

SIZE <b>A</b>	DWG NO <b>WP3401</b>	FILE NAME <b>CD-WP3401</b>	CUST REV <b>1</b>
REVISED DATE 11/09/07	SCALE <b>NONE</b>	SHEET <b>1 OF 1</b>	

2

1