



Pass & Seymour

Weatherproof Boxes & Covers Boxes Single & Two Gang

WPB23, WPB33, WPB232, WPB332

Rugged construction for any wet location, with appropriate cover.

We finish these durable, cast aluminum boxes with a tough, baked-on, electrostatic polyester powder coat for excellent resistance to scratches and corrosion. They are ideal for wet and/or damp locations with appropriate cover. All ship with two closure plugs and mounting lugs.

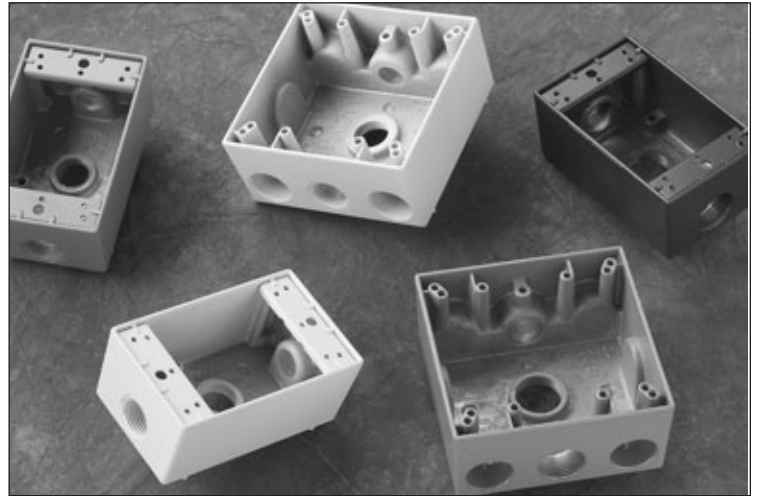

Features & Benefits

Heavy die-cast aluminum.

Available in standard and deep configurations.

Available in 1/2" and 3/4" hub sizes, from 3 to 6 hole configurations.

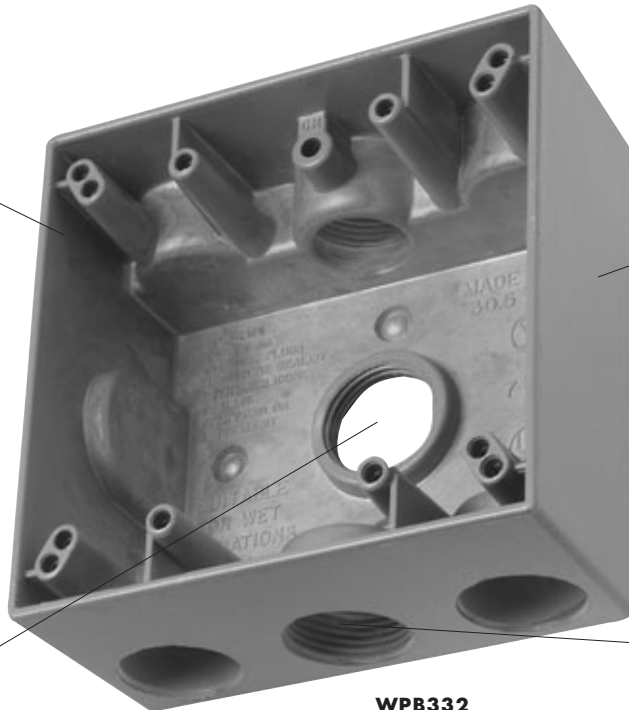

WPB332

Baked-on, electrostatic polyester powder paint for superior scratch- and corrosion-resistant finish.

UL Listed, for wet and/or damp locations with appropriate cover.

Simply strike desired knockout studs with a sharp hammer blow for clean mounting holes.

Field Uses/Vertical Markets

- Industrial
- Health Care
- Education
- Institutional
- Retail
- Office
- Hospitality/Lodging
- Multiple Dwelling





Pass & Seymour

Weatherproof Boxes & Covers

Boxes

Single & Two Gang

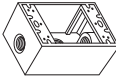
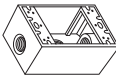
Ordering Information

Catalog Number	Description	Color
Single Gang		
 WPB23 WPB23-BR WPB23-W	3 Hole 1/2", 18.5 Cu. In. (1 Hole Each End, 1 Hole in Back)	Gray Bronze White
 WPB33 WPB33-BR WPB33-W	3 Hole 3/4", 18.5 Cu. In. (1 Hole Each End, 1 Hole in Back)	Gray Bronze White
Two Gang		
 WPB232 WPB232-W	3 Hole 1/2", 30.5 Cu. In. (1 Hole Each End, 1 Hole in Back)	Gray White
 WPB332	3 Hole 3/4", 30.5 Cu. In. (1 Hole Each End, 1 Hole in Back)	Gray

For more information on these and other P&S products refer to our Product Guide or visit our web site.

Weatherproof Boxes & Covers

Boxes

Single & Two Gang



Pass & Seymour

Technical Specifications

3rd Party Compliance

UL Listed.
CSA Certified.

Performance

Environmental	Weatherproof
---------------	--------------

Materials

Body	Cast Aluminum
Screws	Steel, Zinc-Plated
Finish	Baked-On, Electrostatic Polyester Powder Coat

Warranty

1 Year

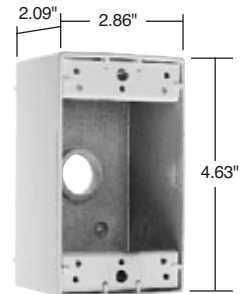

Dimensions for Single Gang Box

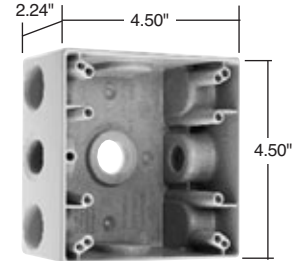

Dimensions for Two Gang Box

Complementary Devices & Accessories

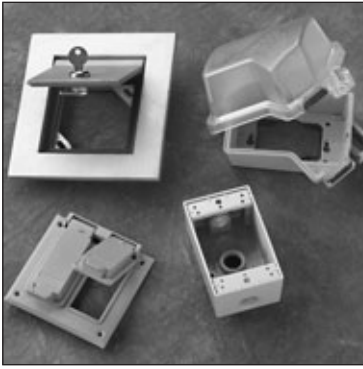

WEATHERPROOF BOXES & COVERS

- While-In-Use Covers
- Heavy Cast Aluminum Covers
- Cast Covers



WALL PLATES

- TradeMaster® Thermoplastic Nylon
- Stainless Steel
- Brass
- Aluminum
- Dustproof Stainless Steel Covers

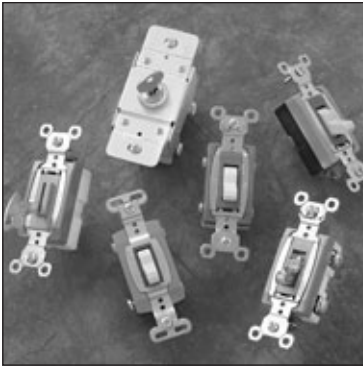

SWITCHES

- Heavy-Duty Toggle
- Heavy-Duty Lighted Toggle
- Heavy-Duty Security
- Heavy-Duty Locking
- Construction Grade Toggle
- Commercial Grade Toggle

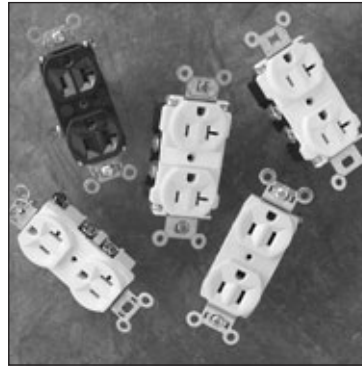

STRAIGHT BLADE RECEPTACLES

- Extra Heavy-Duty
- Heavy-Duty
- Construction Grade
- Commercial Grade



GFCIs

- Construction Grade with Auto-Ground
- Construction Grade
- Construction Grade Dead Front

Also available...

- Light Almond Devices
- Decorator Devices
- Hospital Grade Devices
- PlugTail™ Devices
- TVSS & Isolated Ground Devices
- Ground Continuity Monitoring (GCM)
- Straight Blade Plugs & Connectors
- Turnlok® Locking Devices
- IEC 309 Industrial Products
- Flexcor® Wire Mesh Grips
- Configurable Solutions



Legrand/Pass & Seymour
P.O. Box 4822
Syracuse, NY 13221-4822
800-223-4185

North America Headquarters
60 Woodlawn Street
West Hartford, CT 06110
Phone: 1.877.BY.LEGRAND (295.3472)
Fax: 1.860.232.2062
www.legrand.us

Legrand Canada
570 Applewood Crescent
Vaughan, ON, L4K 4B4
Phone: 905.738.9195
Fax: 905.738.9721
www.legrand.ca



Pass & Seymour

Weatherproof Boxes & Covers Boxes Single & Two Gang

WPB23, WPB33, WPB232, WPB332

Rugged construction for any wet location, with appropriate cover.

We finish these durable, cast aluminum boxes with a tough, baked-on, electrostatic polyester powder coat for excellent resistance to scratches and corrosion. They are ideal for wet and/or damp locations with appropriate cover. All ship with two closure plugs and mounting lugs.

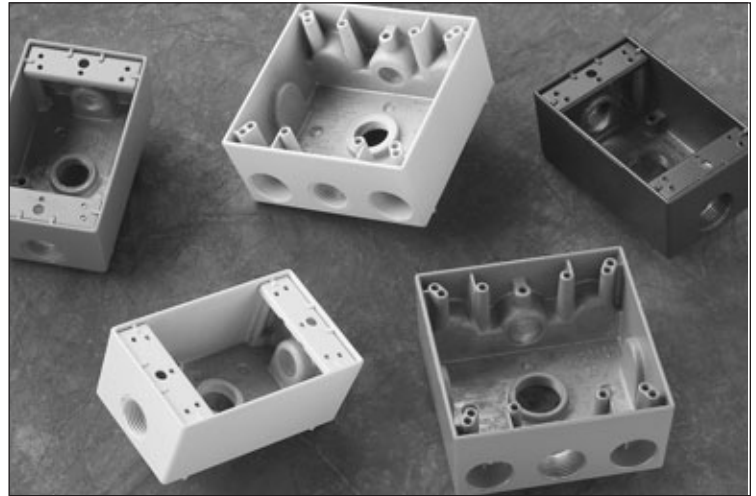

Features & Benefits

Heavy die-cast aluminum.

Available in standard and deep configurations.

Available in 1/2" and 3/4" hub sizes, from 3 to 6 hole configurations.

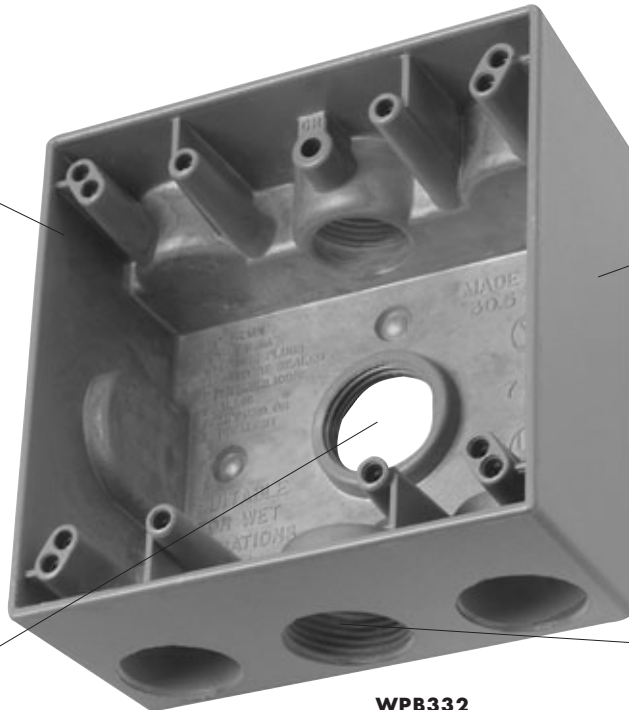

WPB332

Baked-on, electrostatic polyester powder paint for superior scratch- and corrosion-resistant finish.

UL Listed, for wet and/or damp locations with appropriate cover.

Simply strike desired knockout studs with a sharp hammer blow for clean mounting holes.

Field Uses/Vertical Markets

- Industrial
- Health Care
- Education
- Institutional
- Retail
- Office
- Hospitality/Lodging
- Multiple Dwelling





Pass & Seymour

Weatherproof Boxes & Covers

Boxes

Single & Two Gang

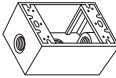
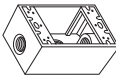
Ordering Information

Catalog Number	Description	Color
Single Gang		
 WPB23 WPB23-BR WPB23-W	3 Hole 1/2", 18.5 Cu. In. (1 Hole Each End, 1 Hole in Back)	Gray Bronze White
 WPB33 WPB33-BR WPB33-W	3 Hole 3/4", 18.5 Cu. In. (1 Hole Each End, 1 Hole in Back)	Gray Bronze White
Two Gang		
 WPB232 WPB232-W	3 Hole 1/2", 30.5 Cu. In. (1 Hole Each End, 1 Hole in Back)	Gray White
 WPB332	3 Hole 3/4", 30.5 Cu. In. (1 Hole Each End, 1 Hole in Back)	Gray

For more information on these and other P&S products refer to our Product Guide or visit our web site.

Weatherproof Boxes & Covers

Boxes

Single & Two Gang



Pass & Seymour

Technical Specifications

3rd Party Compliance	
UL Listed.	
CSA Certified.	

Performance	
Environmental	Weatherproof

Materials	
Body	Cast Aluminum
Screws	Steel, Zinc-Plated
Finish	Baked-On, Electrostatic Polyester Powder Coat

Warranty

1 Year

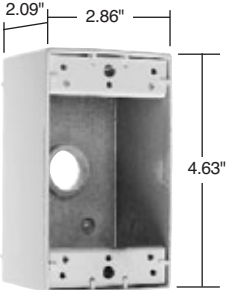

Dimensions for Single Gang Box

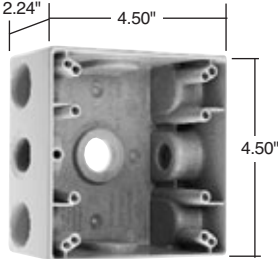

Dimensions for Two Gang Box

Complementary Devices & Accessories

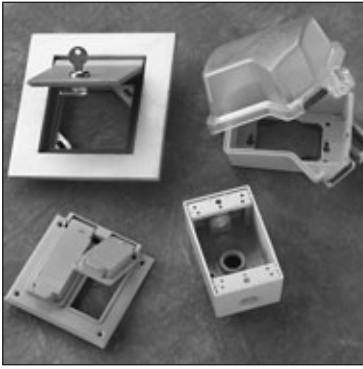

WEATHERPROOF BOXES & COVERS

- While-In-Use Covers
- Heavy Cast Aluminum Covers
- Cast Covers



WALL PLATES

- TradeMaster® Thermoplastic Nylon
- Stainless Steel
- Brass
- Aluminum
- Dustproof Stainless Steel Covers

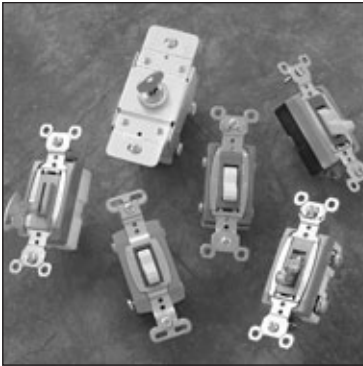

SWITCHES

- Heavy-Duty Toggle
- Heavy-Duty Lighted Toggle
- Heavy-Duty Security
- Heavy-Duty Locking
- Construction Grade Toggle
- Commercial Grade Toggle

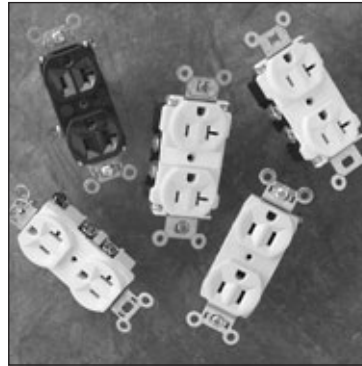

STRAIGHT BLADE RECEPTACLES

- Extra Heavy-Duty
- Heavy-Duty
- Construction Grade
- Commercial Grade



GFCIs

- Construction Grade with Auto-Ground
- Construction Grade
- Construction Grade Dead Front

Also available...

- Light Almond Devices
- Decorator Devices
- Hospital Grade Devices
- PlugTail™ Devices
- TVSS & Isolated Ground Devices
- Ground Continuity Monitoring (GCM)
- Straight Blade Plugs & Connectors
- Turnlok® Locking Devices
- IEC 309 Industrial Products
- Flexcor® Wire Mesh Grips
- Configurable Solutions



Legrand/Pass & Seymour
P.O. Box 4822
Syracuse, NY 13221-4822
800-223-4185

North America Headquarters
60 Woodlawn Street
West Hartford, CT 06110
Phone: 1.877.BY.LEGRAND (295.3472)
Fax: 1.860.232.2062
www.legrand.us

Legrand Canada
570 Applewood Crescent
Vaughan, ON, L4K 4B4
Phone: 905.738.9195
Fax: 905.738.9721
www.legrand.ca