

KT-WPLEDXXPS-X3-8CSB-VDIM-X

ADJUSTABLE WALL PACK

DESCRIPTION

0° - 90° Adjustable LED Wall Pack | Power Select | Color Select | 120-277V | Bronze or White Housing

APPLICATION

Commercial wall mount applications for outdoor illumination (alleys, pathways, landscape lighting)



PRODUCT FEATURES

- Keystone Power Select technology (see *Performance Specifications* for details)
 - Keystone Color Select technology (3000/4000/5000K)
 - 0° - 90° field adjustable light positioning to illuminate areas missed by traditional forward throw wall packs
 - Heavy-duty, die-cast aluminum housing with enhanced performance and reliability
 - Built-in dusk-to-dawn photocell behind translucent 3/4" threaded plug with antiyellowing agent
 - Powered by Keystone 0-10V dimming LED drivers
 - Ambient operating temperature: -40°C/-40°F - 50°C/122°F
 - UL certified, IP65 rated
 - THD: < 20%
 - LED chip lifetime: L70 > 100,000 hrs @ 25°C/77°F ambient fixture temperature
 - Meets FCC Part 15, Part B, Class A standards for conducted and radiated emissions
- ** TAA options available. See *Ordering Information* below**

PRODUCT IMAGES



KT-WPLED35PS-S3-8CSB-VDIM



KT-WPLED35PS-S3-8CSB-VDIM-W



KT-WPLED75PS-M3-8CSB-VDIM



KT-WPLED75PS-M3-8CSB-VDIM-W

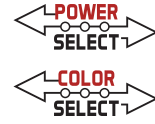

KT-WPLEDXXPS-X3-8CSB-VDIM-X

ADJUSTABLE WALL PACK

PRODUCT SPECIFICATIONS

Catalog Number	Wattage	CCT	Lumens	Efficacy	Dimming	CRI	Input Voltage	Photocell	Housing Color	Rated Life	Legacy Equivalent
KT-WPLED35PS-S3-8CSB-VDIM KT-WPLED35PS-S3-8CSB-VDIM-W	35W	3000K	4375	125 lm/W	0-10V	> 80	120-277V	Included	Bronze or white options available	50,000 hrs	150W MH
		4000K	5075	145 lm/W							
		5000K	4725	135 lm/W							
	25W	3000K	3375	135 lm/W							
		4000K	3750	150 lm/W							
		5000K	3625	145 lm/W							
	15W	3000K	2178	145 lm/W							
		4000K	2325	155 lm/W							
		5000K	2250	150 lm/W							
KT-WPLED75PS-M3-8CSB-VDIM KT-WPLED75PS-M3-8CSB-VDIM-W	75W	3000K	9375	125 lm/W	0-10V	> 80	120-277V	Included	Bronze or white options available	50,000 hrs	320W MH
		4000K	10875	145 lm/W							
		5000K	10125	135 lm/W							
	60W	3000K	8100	135 lm/W							
		4000K	9000	150 lm/W							
		5000K	8700	145 lm/W							
	45W	3000K	6319	140 lm/W							
		4000K	6975	155 lm/W							
		5000K	6750	150 lm/W							

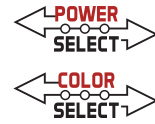

KT-WPLEDXXPS-X3-8CSB-VDIM-X

ADJUSTABLE WALL PACK

PHYSICAL SPECIFICATIONS

KT-WPLED35PS-S3-8CSB-VDIM-X

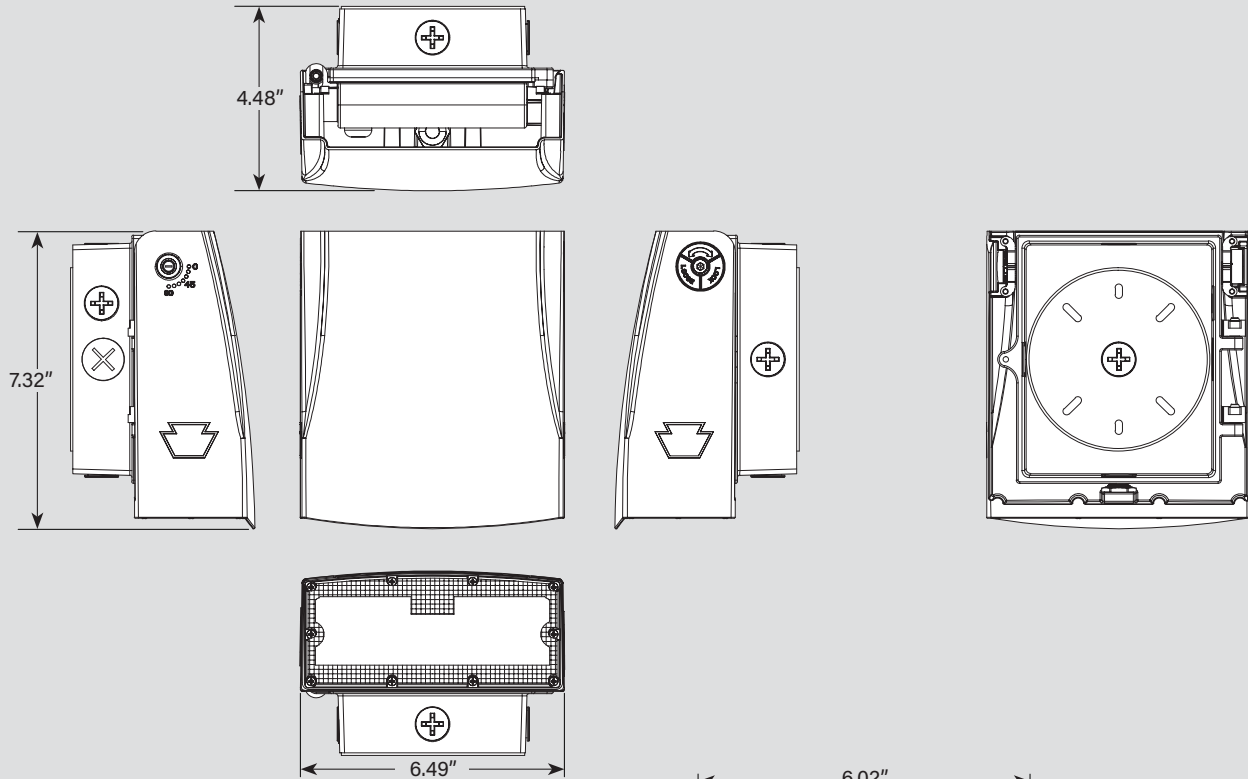

MOUNTING PLATE

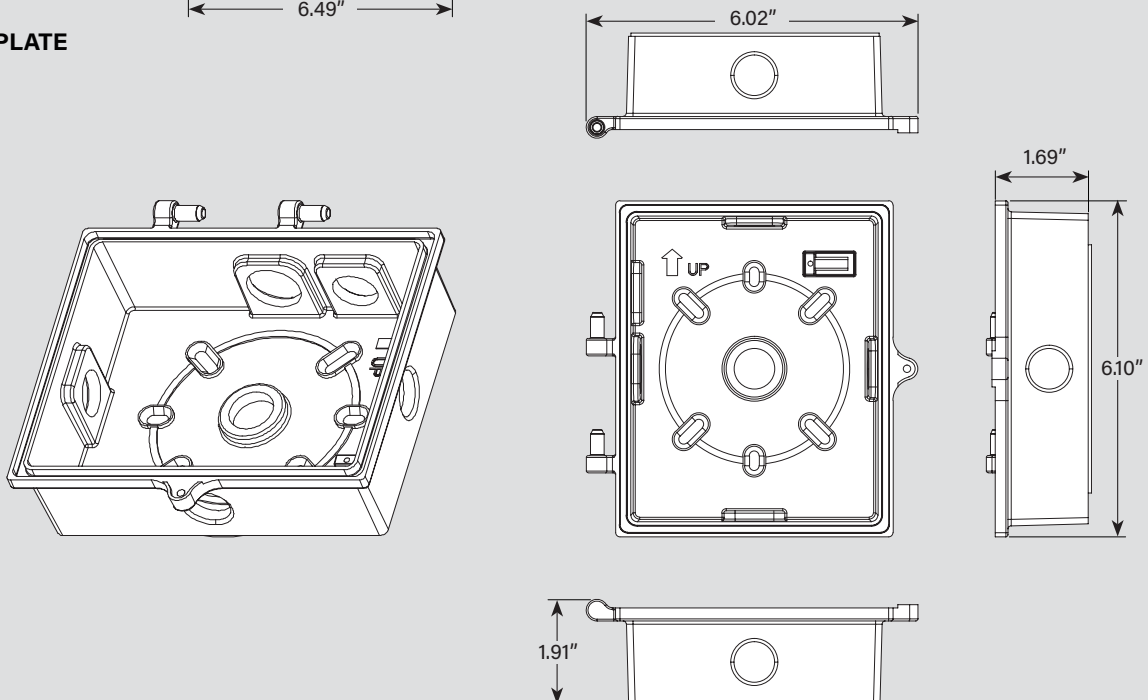

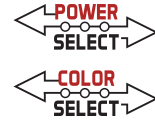

KT-WPLEDXXPS-X3-8CSB-VDIM-X

ADJUSTABLE WALL PACK

PHYSICAL SPECIFICATIONS (CONTINUED)

KT-WPLED75PS-M3-8CSB-VDIM-X

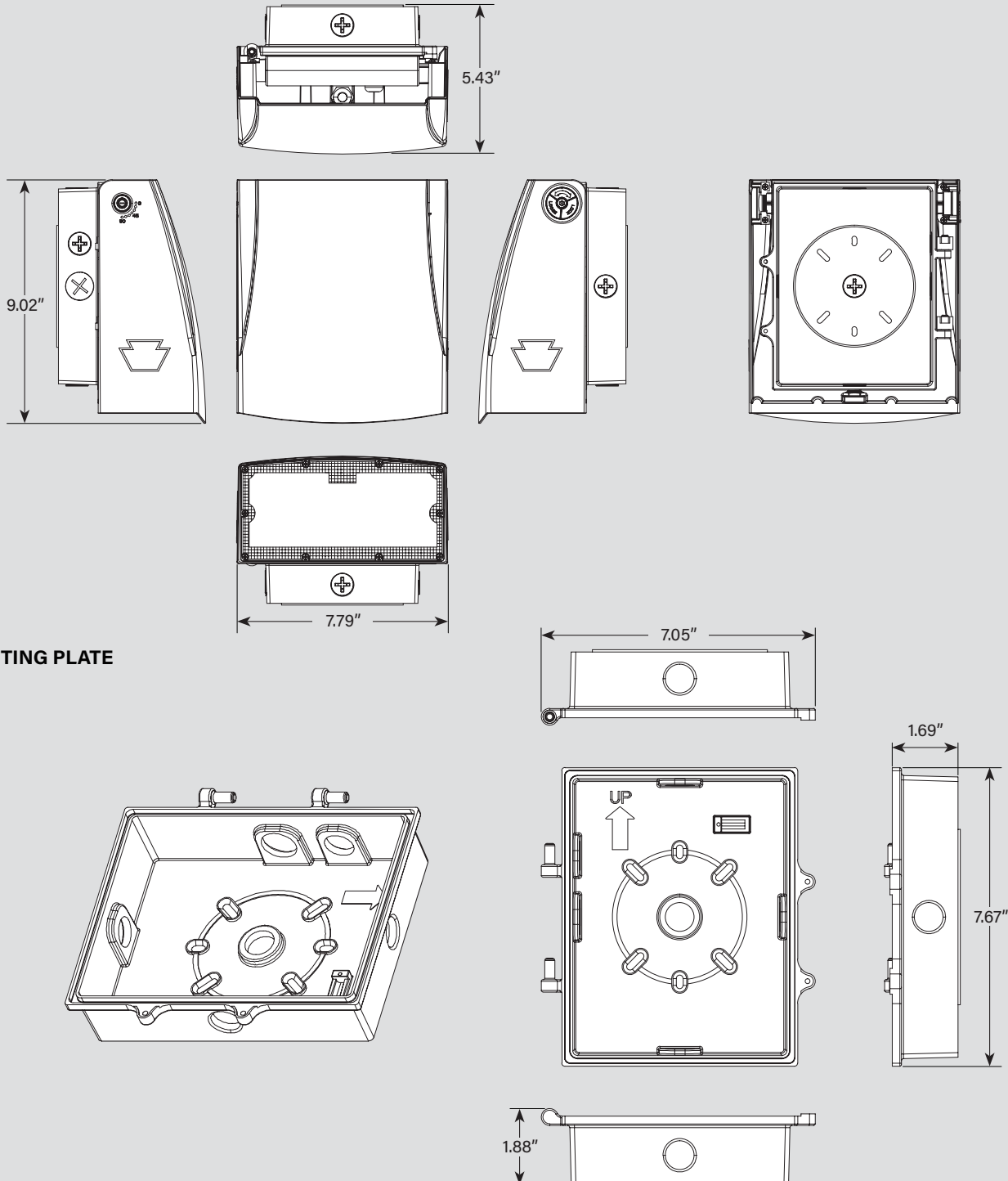

MOUNTING PLATE

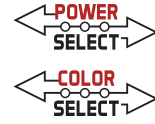

KT-WPLEDXXPS-X3-8CSB-VDIM-X

ADJUSTABLE WALL PACK

GENERAL SETUP INSTRUCTIONS

GENERAL WIRING DIAGRAM

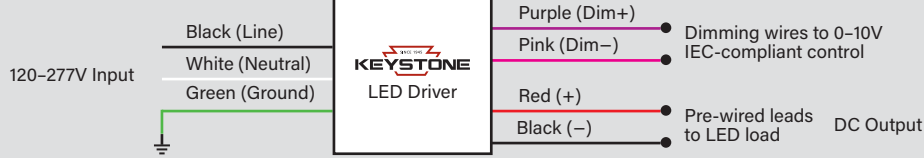

Caution: Before installing, make certain that AC power to the fixture is off.

Caution: The electrical rating of this product is 120-277V. Installer must confirm that there is 120-277V at the fixture before installation.

Note: *In accordance with NEC-20 410.69 2022, all 0-10V negative wires have been updated from gray to pink. Please contact Keystone for details

ANGLE ADJUSTMENT INSTRUCTIONS

1. Loosen the screw on the side of the housing using an Allen wrench.
2. Adjust housing to desired setting, 0° - 90° in 15° intervals.
3. Tighten the screw on the side of the housing using the Allen wrench in Step 1.

PHOTOCELL AND CCT ADJUSTMENT

This fixture is equipped with a dusk-to-dawn photocell behind the translucent knockout (KO). Enable or disable the photocell by removing the cap and adjusting the dip switch to your desired setting. Fixture comes preset with photocell enabled. This fixture is also equipped with Keystone Color Select technology. The CCT dip switch is located in the same KO as the photocell. Remove the cap and adjust to your desired setting. This fixture comes preset to 5000K.

WATTAGE ADJUSTMENT

This fixture is equipped with Keystone Power Select technology. The adjustable knob is located in the driver compartment. See instructions below on how to access. Fixture comes preset to either 75W or 35W, depending on model ordered.

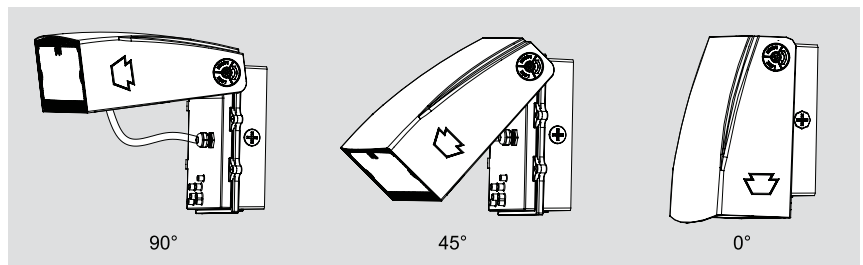
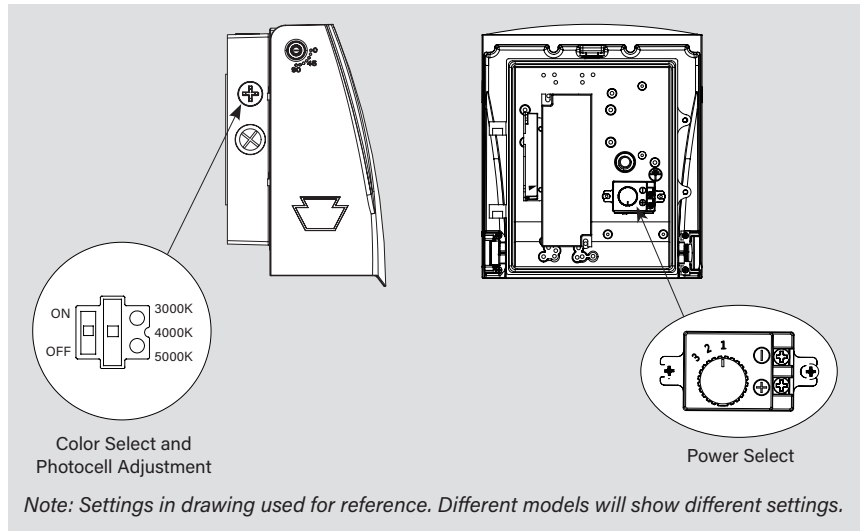

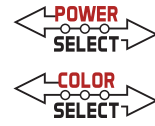

KT-WPLEDXXPS-X3-8CSB-VDIM-X

ADJUSTABLE WALL PACK

PHOTOMETRICS SPECIFICATIONS

KT-WPLED35PS-S3-8CSB-VDIM

KT-WPLED35PS-S3-8CSB-VDIM-W

35W 5000K
Building mounted 15'

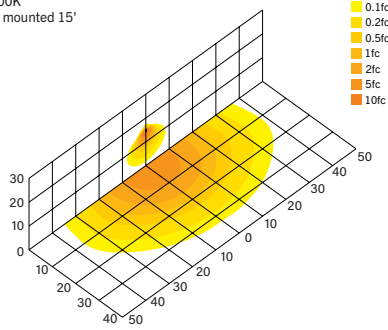

25W 5000K
Building mounted 15'

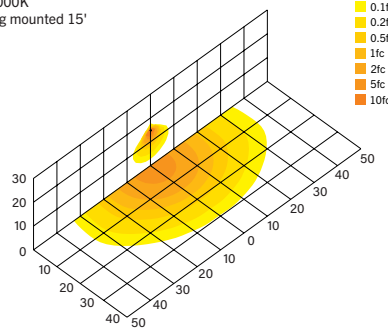

15W 5000K
Building mounted 15'

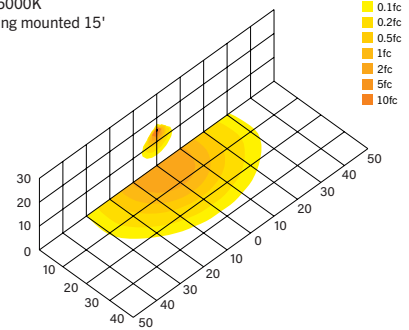

Luminous Intensity Distribution Curve

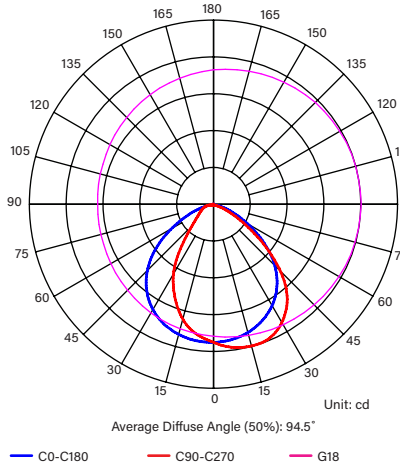

Isocandela (Rectangle)

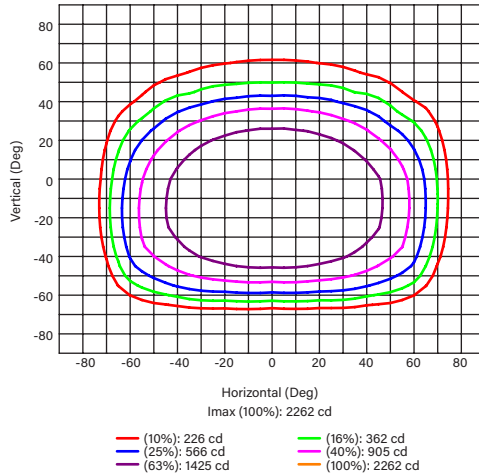

Flux Distribution

ZONE	LUMENS	% LAMP LUMENS
FORWARD LIGHT	2938	60.3
FL (0° - 30°)	904	18.6
FM (30° - 60°)	1674	34.4
FH (60° - 80°)	352	7.2
FVH (80° - 90°)	9	0.2
BACK LIGHT	1886	38.7
BL (0° - 30°)	768	15.8
BM (30° - 60°)	917	18.8
BH (60° - 80°)	175	3.6
BVH (80° - 90°)	23	0.5
UP LIGHT	49	1.0
UL (90° - 100°)	5	0.1
UH (100° - 180°)	44	0.9
TRAPPED LIGHT	NA	NA
BUG (Backlight, Uplight, Glare) Rating Base On TM-15-07		
Aysmmetrical Luminaire Types (Type I, II, III, IV)	B2 U2 G1	
Quadrilateral Symmetrical Luminaire Types (Type V, Area Light)	B2 U2 G1	

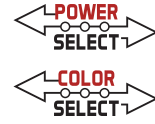

KT-WPLEDXXPS-X3-8CSB-VDIM-X

ADJUSTABLE WALL PACK

PHOTOMETRIC SPECIFICATIONS (CONTINUED)

KT-WPLED75PS-M3-8CSB-VDIM

KT-WPLED75PS-M3-8CSB-VDIM-W

75W 5000K
Building mounted 18'

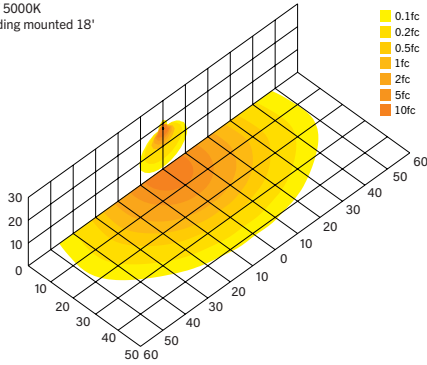

65W 5000K
Building mounted 18'

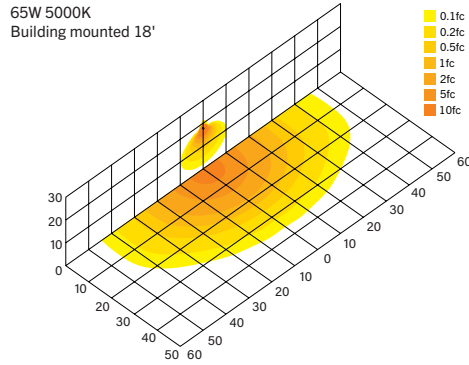

45W 5000K
Building mounted 18'

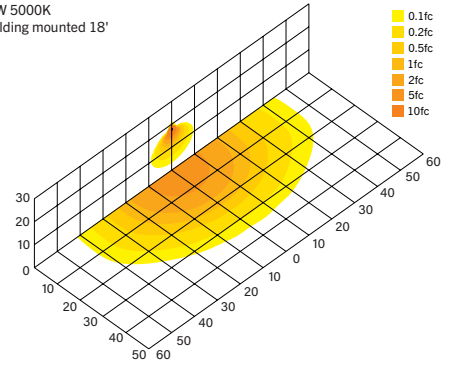

Luminous Intensity Distribution Curve

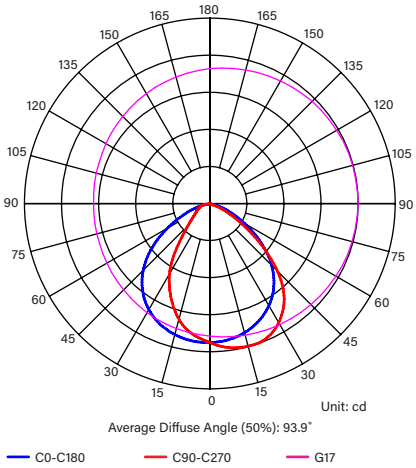

Isocandela (Rectangle)

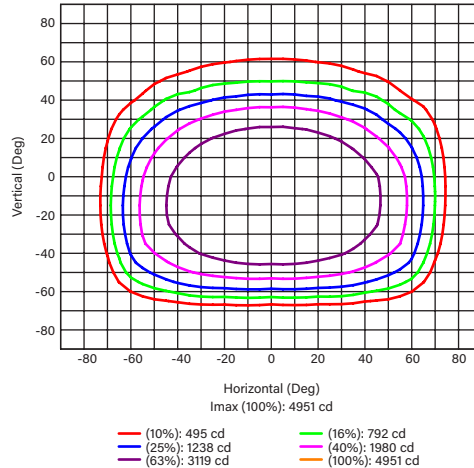

Flux Distribution

ZONE	LUMENS	% LAMP LUMENS
FORWARD LIGHT	6299	59.9
FL (0° - 30°)	1967	18.7
FM (30° - 60°)	3602	34.3
FH (60° - 80°)	715	6.8
FVH (80° - 90°)	15	0.1

BACK LIGHT	4116	39.2
BL (0° - 30°)	1642	15.6
BM (30° - 60°)	1980	18.8
BH (60° - 80°)	429	4.1
BVH (80° - 90°)	64	0.6

UP LIGHT	94	0.9
UL (90° - 100°)	11	0.1
UH (100° - 180°)	83	0.8

TRAPPED LIGHT	NA	NA
----------------------	-----------	-----------

BUG (Backlight, Uplight, Glare) Rating Base On TM-15-07	
Aysmmetrical Luminaire Types (Type I, II, III, IV)	B3 U2 G1
Quadrilateral Symmetrical Luminaire Types (Type V, Area Light)	B3 U2 G1

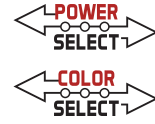

KT-WPLEDXXPS-X3-8CSB-VDIM-X

ADJUSTABLE WALL PACK

ACCESSORIES

EMERGENCY BACKUP

Field-Installable (purchased separately)

✓	SUFFIX*	CATALOG NUMBER	DESCRIPTION	UPC	EASY CODE
	-	KT-EMRG-LED-12C-1200	LED Emergency Back-Up, 12W Constant Wattage Design. Approx 1200 Lumens. 120-277V Input. Remote Compact Battery Pack. CEC T20 Compliant.	843654103112	OJQ-32
	-	KT-EMRG-LED2-TS-IP65	IP65 Rated Wet Location Test Switch for 5W and 12W CEC Compliant LED Emergency Packs	843654130019	MDB-29



12W, 1200 lumen Battery Backup
KT-EMRG-LED-12C-1200



Wet Location Test Switch
KT-EMRG-LED2-TS-IP65

Note: emergency back up must be installed in remote junction box. Emergency pack will not fit inside of fixture.

SURGE PROTECTORS

Factory-Installable OR Field-Installable (field-installable purchased separately)

✓	SUFFIX*	CATALOG NUMBER	DESCRIPTION	UPC	EASY CODE
	/10KV	KTSP-10KV-C	External Surge Protector, compact design. Parallel Wiring, 120-277V Input, Max Peak Protection (10KV, 10KA)	843654129204	BUU-26



External Surge Protector
KTSP-10KV-C

* For factory installation of accessory, add suffix to fixture part number (see ordering examples and instructions on last page of spec sheet).

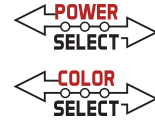

KT-WPLEDXXPS-X3-8CSB-VDIM-X

ADJUSTABLE WALL PACK

ORDERING INFORMATION

CATALOG NUMBER	UPC	EASY CODE	DLC PRODUCT ID
KT-WPLED35PS-S3-8CSB-VDIM	843654141848	ZRH-81	S-WN3FD9
KT-WPLED35PS-S3-8CSB-VDIM /TAA	843654158778	SRE-94	
KT-WPLED35PS-S3-8CSB-VDIM-W	843654141855	NXL-27	
KT-WPLED75PS-M3-8CSB-VDIM	843654141862	GAB-57	S-1HRBW6
KT-WPLED75PS-M3-8CSB-VDIM /TAA	843654158785	CVR-10	
KT-WPLED75PS-M3-8CSB-VDIM-W	843654141879	NGW-82	

CATALOG NUMBER BREAKDOWN

KT-WPLEDXXPS-X3-8CSB-VDIM-X

1	2	3	4	5	6	7	8	9	10	11	12	13
1 Keystone Technologies	2 Wall Pack	3 LED	4 Max Wattage	5 Power Select	6 Size	7 Style	8 CRI	9 Color Select	10 Color Select Designation	11 0-10V Dimming	12 Housing Color	13 TAA Compliant
					S Small		8 >80		B 3000/4000/5000K		White	/TAA Made in Mexico
					M Medium							

ORDERING EXAMPLES

FIXTURE WITH ONE FACTORY-INSTALLED ACCESSORY

KT-WPLED75PS-M3-8CSB-VDIM /10KV

FIXTURE WITH NO FACTORY-INSTALLED ACCESSORIES

KT-WPLED75PS-M3-8CSB-VDIM

KEYSTONE FIXTURE

CATALOG NUMBER
KT-WPLED75PS-M3-8CSB-VDIM

SURGE PROTECTORS

SUFFIX	CATALOG NUMBER
/10KV	KTSP-10KV-C

*When ordering more than one factory-installed accessory, use multiple suffixes as shown in the ordering examples above.
 Note: All accessories can also be ordered separately for field installation using just their regular Catalog Number, UPC, or Easy Code.