

KT-WPLED80PS-M4-8CSB-VDIM

SLIM 80W LED WALL PACK

DESCRIPTION

Slim Non Cutoff LED Wall Pack | Power Select | Color Select |
120-277V Input | Medium Housing | Bronze Finish | Glass Lens

APPLICATION

Building mount for exterior illumination (perimeters, pathways, loading docks, and other general security lighting requirements)



PRODUCT FEATURES

- Keystone Power Select technology (80/70/55W)
- Keystone Color Select technology (3000/4000/5000K)
- Slim, low profile design that matches footprint and distribution of legacy HID wall packs. Optimized for one-for-one replacements
- Heavy duty die cast aluminum housing with (5) 1/2" threaded conduit hubs: (1) on back and (1) on all four sides
- Powered by Keystone 0–10V dimming LED drivers
- Built-in dusk-to-dawn photocell behind translucent 3/4" threaded plug with anti-yellowing agent
- Borosilicate glass lens diffuses light source and provides uniform distribution
- Covers footprint of mid-size HID wallpacks
- Ambient operating temperature: –40°C/–40°F to 50°C/122°F
- UL Certified for wet locations; IP65 rated
- Fixture impact rating IK06
- Power Factor: >0.95
- THD: <20%
- LED chip lifetime: L70 >100,000 hrs @ 25°C/77°F ambient fixture temperature
- Meets FCC Part 15, Part B, Class A standards for conducted and radiated emissions

PRODUCT SPECIFICATIONS

| Catalog Number | Wattage | CCT | Lumens | Efficacy | Input Voltage | Dimming | CRI | Photocell | Housing Color | Legacy Equivalent |
|---------------------------|---------|-------|----------|----------|---------------|---------|-----|-----------|---------------|-------------------|
| KT-WPLED80PS-M4-8CSB-VDIM | 80W | 3000K | 10560 lm | 132 lm/W | 120–277V | 0–10V | >80 | Included | Bronze | 320W MH |
| | | 4000K | 11280 lm | 141 lm/W | | | | | | |
| | | 5000K | 10960 lm | 137 lm/W | | | | | | |
| | 70W | 3000K | 9380 lm | 134 lm/W | | | | | | |
| | | 4000K | 10010 lm | 143 lm/W | | | | | | |
| | | 5000K | 9800 lm | 140 lm/W | | | | | | |
| | 55W | 3000K | 7645 lm | 139 lm/W | | | | | | |
| | | 4000K | 8030 lm | 146 lm/W | | | | | | |
| | | 5000K | 7975 lm | 145 lm/W | | | | | | |

* Color Uniformity: CCT (Correlated Color Temperature) range as per guidelines outlined in ANSI C78.377-2017

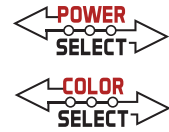

KT-WPLED80PS-M4-8CSB-VDIM

SLIM 80W LED WALL PACK

PHYSICAL SPECIFICATIONS

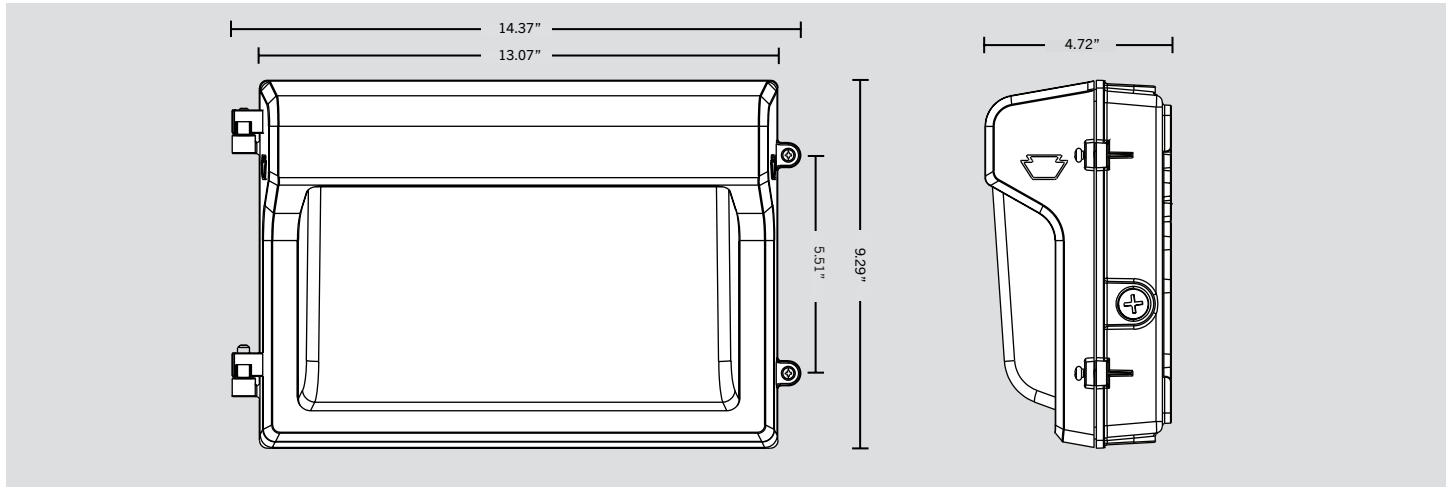

GENERAL SETUP INSTRUCTIONS

GENERAL WIRING DIAGRAM

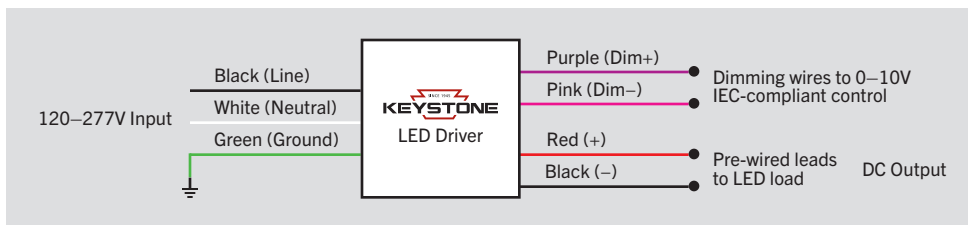

Caution: Before installing, make certain that AC power to the fixture is off.

Caution: The electrical rating of this product is 120–277V. Installer must confirm that there is 120–277V at the fixture before installation.

PHOTOCELL ENABLE/DISABLE

This fixture is equipped with a dusk-to-dawn photocell behind the translucent knock-out (KO) cover. Adjust the dip switch to enable (ON) or disable (OFF) the photocell function (see illustrations to the right). Fixture comes pre-set with photocell enabled unless otherwise noted.

COLOR SELECT (CCT) ADJUSTMENT

This fixture is equipped with Color Select technology. There is an adjustable dip switch behind the translucent knock-out (KO) cover to change CCT between 5000K, 4000K, and 3000K (see illustrations to the right). Fixture comes pre-set at 5000K unless otherwise noted.

POWER SELECT (WATTAGE) ADJUSTMENT

The Power Select dial for this fixture is located inside of the housing. To access the dial, open the fixture face (see below instructions for reference). This wall pack is selectable between 3 wattage options, and is pre-set to the highest option. Please see chart below for details.

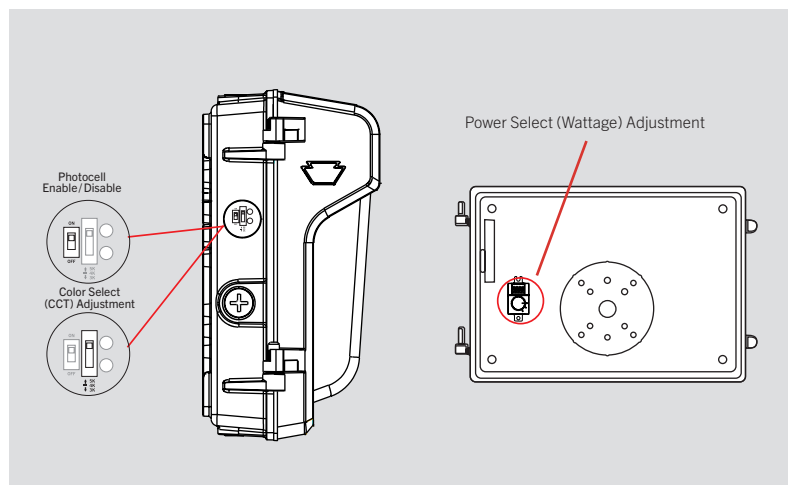

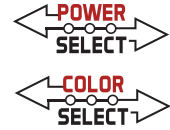

KT-WPLED80PS-M4-8CSB-VDIM

SLIM 80W LED WALL PACK

PHOTOMETRIC SPECIFICATIONS

ISOCANDELA PLOT

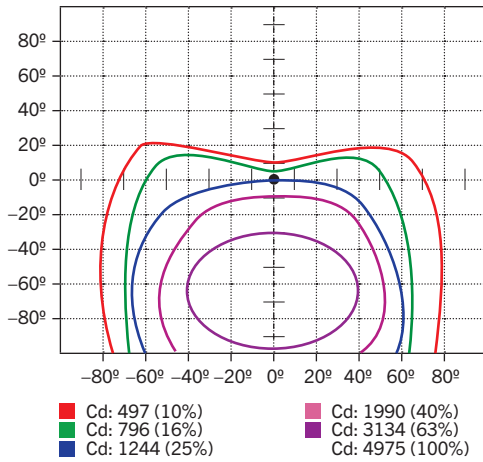

LUMINOUS INTENSITY DISTRIBUTION

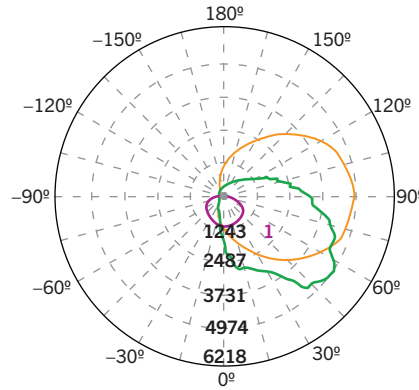

Average diffuse angle (50%): 122.7°

- 1 Violet C0-C180
- 2 Green C90-C270
- 3 Orange G56

Unit: cd

FLUX DISTRIBUTION

| Zone | Lumens | % Luminaire |
|----------------------|----------|-------------|
| Forward Light | 8,333 lm | 77.0% |
| 0°-30° | 985 lm | 9.1% |
| 30°-60° | 3,431 lm | 31.7% |
| 60°-80° | 2,829 lm | 26.1% |
| 80°-90° | 1,088 lm | 10.1% |
| Back Light | 561 lm | 5.2% |
| 0°-30° | 201 lm | 1.9% |
| 30°-60° | 219 lm | 2.0% |
| 60°-80° | 113 lm | 1.0% |
| 80°-90° | 27 lm | 0.2% |
| Up Light | 1,929 lm | 17.8% |
| 90°-100° | 790 lm | 7.3% |
| 100°-180° | 1,139 lm | 10.5% |

| BUG* Rating | |
|---|----------|
| Asymmetrical Luminaire Types | |
| Type I, II, III, IV | B1 U5 G5 |
| Quadrilateral Symmetrical Luminaire Types | |
| Type V, Area Light | B1 U5 G5 |

* Backlight, Uplight, Glare

MOUNTING

Side view

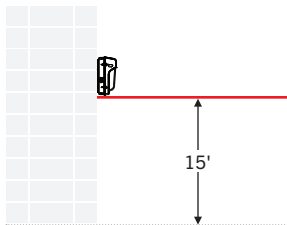

LIGHT DISTRIBUTION PATTERN

Isometric view from above; Luminaire mounted at 15'

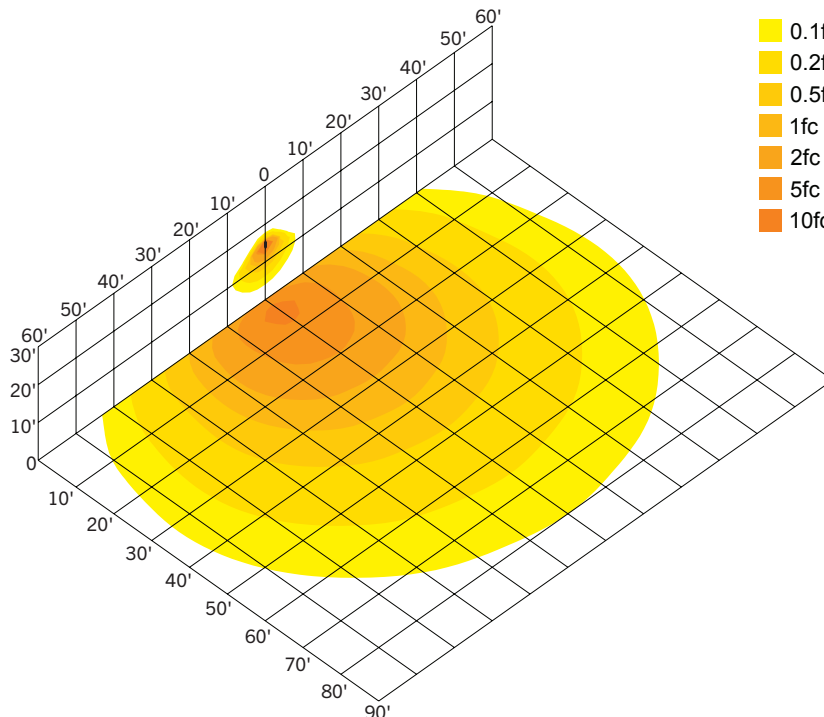

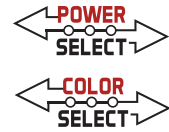

KT-WPLED80PS-M4-8CSB-VDIM

SLIM 80W LED WALL PACK

ACCESSORIES

SENSORS

Factory-Installable OR Field-Installable (field-installable purchased separately)

| ✓ | SUFFIX* | CATALOG NUMBER | DESCRIPTION | UPC | EASY CODE |
|---|---------|------------------|---|--------------|-----------|
| | /MW3 | KTS-MW3-UV-KO-K1 | Microwave Sensor Kit, Includes 120-277V input to 12V DC convertor & 12V input sensor head, IP65. Bi-Level Control with Adjustable Hold Time, Dim Level and Standby Time. Installs via standard 1/2in KO | 843654134147 | BKG-51 |



* For factory installation of accessory, add suffix to fixture part number (see ordering examples and instructions on last page of spec sheet).

CORD SETS

Factory-Installable OR Field-Installable (field-installable purchased separately)

| ✓ | SUFFIX* | CATALOG NUMBER | DESCRIPTION | UPC | EASY CODE |
|---|---------|--------------------|--|--------------|-----------|
| | /515P6 | KT-CS-515P-6-18/3 | Cord set for high bay; 125V NEMA 5-15P; straight blade plug; 6' SJTOW cable; 18/3 wire | 843654140124 | UKH-26 |
| | /L515P6 | KT-CS-L515P-6-16/3 | Cord set for high bays; 250V NEMA L5-15P; twist lock plug; 6' SJTOW cable; 16/3 wire | 843654140186 | POC-82 |

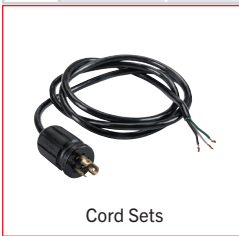

* For factory installation of accessory, add suffix to fixture part number (see ordering examples and instructions on last page of spec sheet).
 Note: For cord sets not listed here, please contact your Keystone sales rep.

MOUNTS AND BRACKETS

Field-Installable / Field-Use ONLY (purchased separately)

| ✓ | SUFFIX* | CATALOG NUMBER | DESCRIPTION | UPC | EASY CODE |
|---|---------|----------------|--|--------------|-----------|
| | - | KT-WPLED-BP-M | Back Plate for Medium Size Wallpacks, Covers Legacy Style Large HID Housing Dimensions. Standard Bronze Color. | 843654130613 | CCJ-21 |

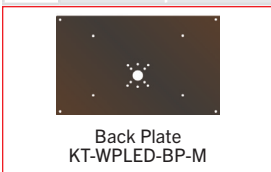

* For factory installation of accessory, add suffix to fixture part number (see ordering examples and instructions on last page of spec sheet).

* For factory installation of accessory, add suffix to fixture part number (see ordering examples and instructions on last page of spec sheet).

(Accessories continued on next page)

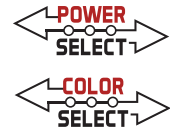

KT-WPLED80PS-M4-8CSB-VDIM

SLIM 80W LED WALL PACK

ACCESSORIES (continued)

SURGE PROTECTORS

Factory-Installable OR Field-Installable (field-installable purchased separately)

| ✓ | SUFFIX* | CATALOG NUMBER | DESCRIPTION | UPC | EASY CODE |
|---|---------|----------------|---|--------------|-----------|
| | /10KV | KTSP-10KV-C | External Surge Protector, compact design. Parallel Wiring, 120-277V Input, Max Peak Protection (10KV, 10KA) | 843654129204 | BUU-26 |



* For factory installation of accessory, add suffix to fixture part number (see ordering examples and instructions on last page of spec sheet).

ORDERING INFORMATION

| CATALOG NUMBER | PACK QTY. | EASY CODE | UPC |
|---------------------------|-----------|-----------|--------------|
| KT-WPLED80PS-M4-8CSB-VDIM | 1 | UCX-21 | 843654155548 |

CATALOG NUMBER BREAKDOWN

KT-WPLED80PS-M4-8CSB-VDIM

- 1
- 2
- 3
- 4
- 5
- 6
- 7
- 8
- 9
- 10
- 11

1 Keystone Technologies

2 Fixture Type

3 LED Lamp

4 Max Wattage

5 Power Select

6 Size

7 Style

8 Color Temperature

9 Color Select Designation

10 Dimming

11 Additional Options (see below for details)

2 Fixture Type

| | |
|----|-----------|
| WP | Wall Pack |
|----|-----------|

6 Size

| | |
|---|--------|
| M | Medium |
|---|--------|

7 Style

| | |
|---|-------------------|
| 4 | Slim, Low Profile |
|---|-------------------|

8 CRI

| | |
|---|-----|
| 8 | >80 |
|---|-----|

9 Color Select Designation

| | |
|---|-----------------|
| B | 3000/4000/5000K |
|---|-----------------|

10 Dimming

| | |
|------|-------|
| VDIM | 0-10V |
|------|-------|

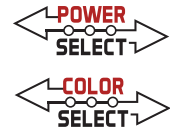

KT-WPLED80PS-M4-8CSB-VDIM

SLIM 80W LED WALL PACK

ORDERING EXAMPLES

FIXTURE WITH MULTIPLE FACTORY-INSTALLED ACCESSORIES*

KT-WPLED80PS-M4-8CSB-VDIM /MW3/515P6



FIXTURE WITH SINGLE FACTORY-INSTALLED ACCESSORY

KT-WPLED80PS-M4-8CSB-VDIM /MW3

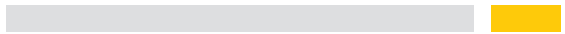

FIXTURE WITH NO FACTORY-INSTALLED ACCESSORIES

KT-WPLED80PS-M4-8CSB-VDIM

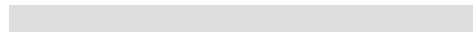

*When ordering more than one factory-installed accessory, use multiple suffixes as shown in the ordering examples above.
 Note: All accessories can also be ordered separately for field installation using just their regular Catalog Number, UPC, or Easy Code.

| KEYSTONE FIXTURE | |
|-------------------------|--|
| CATALOG NUMBER | |
| KT-WPLED35-M1-8CSB-VDIM | |

| SENSORS | | |
|-------------------------------------|--------|------------------|
| | SUFFIX | CATALOG NUMBER |
| <input checked="" type="checkbox"/> | /MW3 | KTS-MW3-UV-KO-K1 |

| CORD SETS | | |
|-------------------------------------|--------|-------------------|
| | SUFFIX | CATALOG NUMBER |
| <input checked="" type="checkbox"/> | /515P6 | KT-CS-515P-6-18/3 |