

REV	DATE	DESCRIPTION	ECO	BY	C'H'K.
P	2023-06-30 01:00:00 EDT	UPDATED AS PER MARKUP	230627031427	YR	RA

CONNECTOR SIZE	TOLERANCES						
	B	C	E	K DIA.	L	N	O.D.
-6C	±.03	+0.04 -.02	±.02	±.02	±.06	±.04	±.01
-8C THRU -25	±.06	±.04	±.02	±.02	±.09	±.04	±.01
-26 THRU -34	±.08	±.04	±.02	±.02	±.12	±.04	±.01
-35 AND UP	±.09	±.06	±.02	±.02	±.15	±.06	±.01

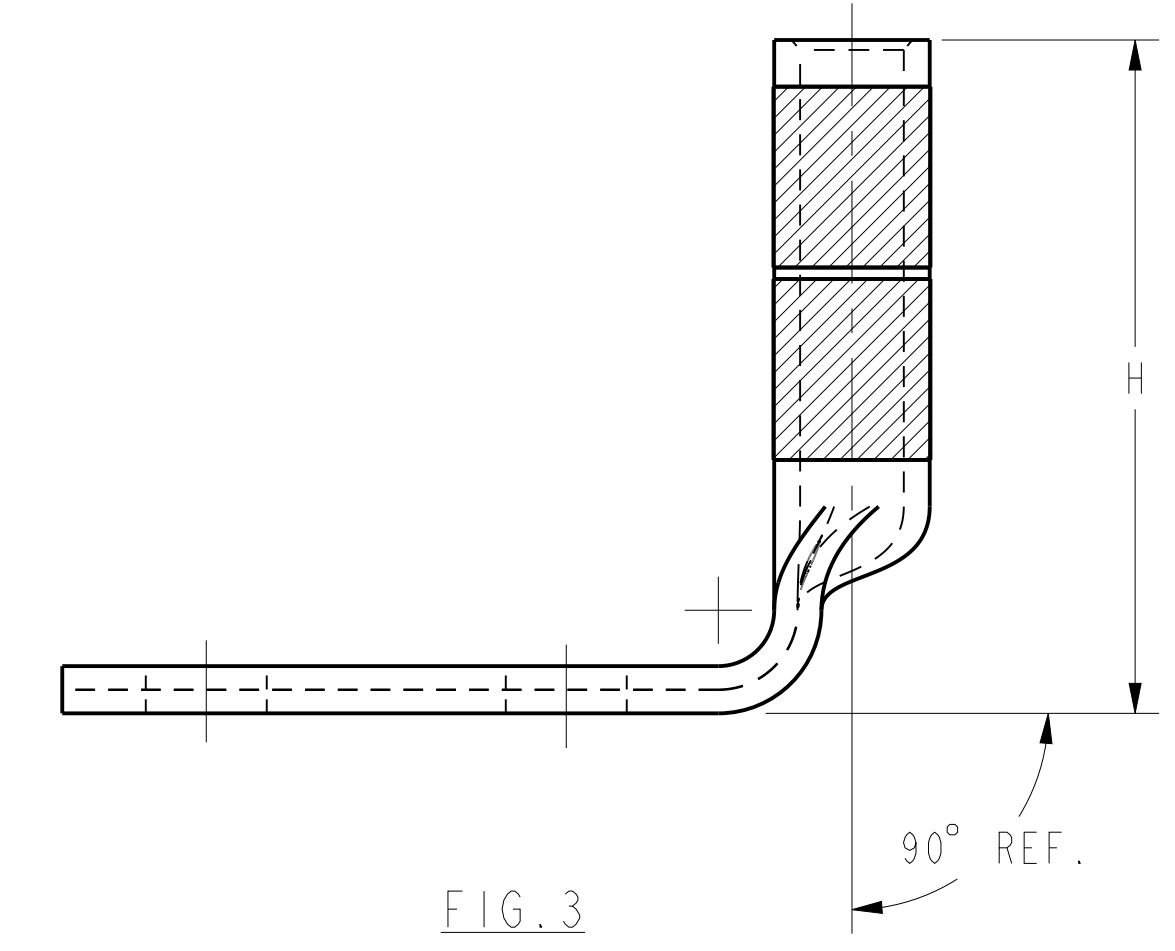

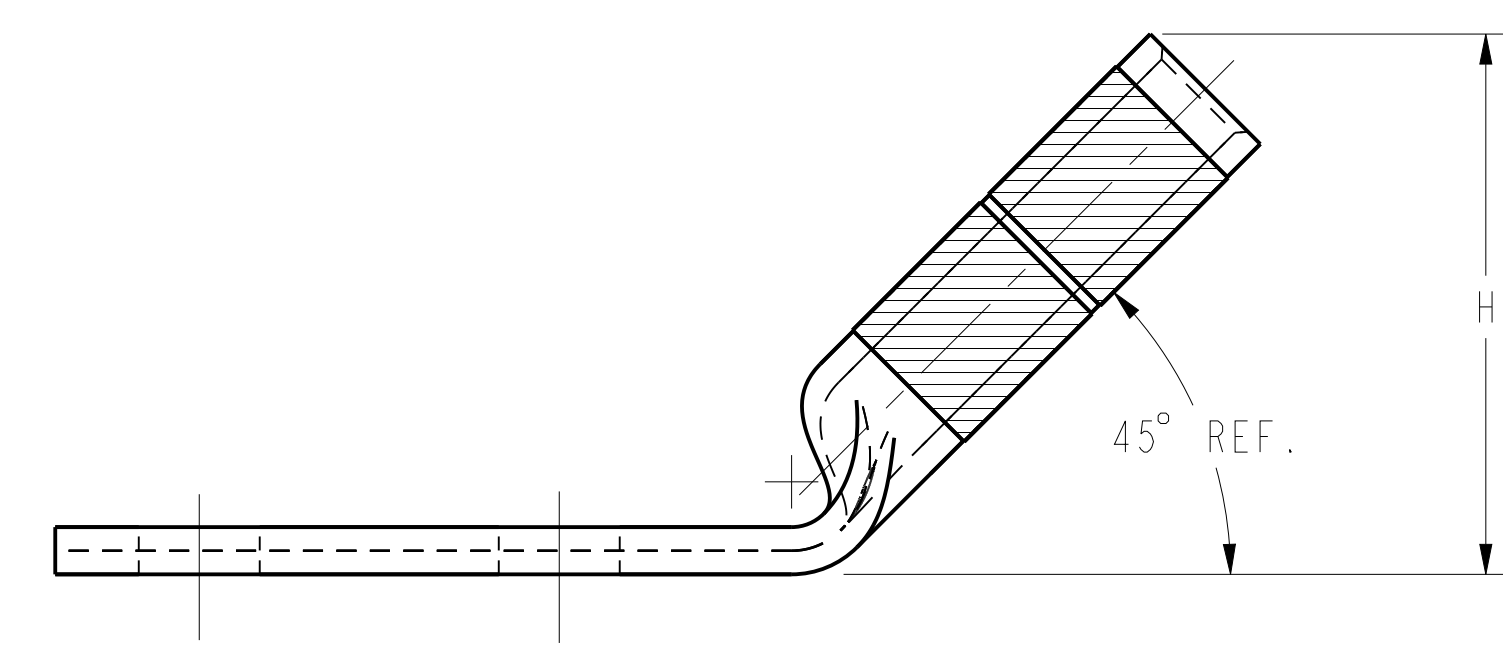

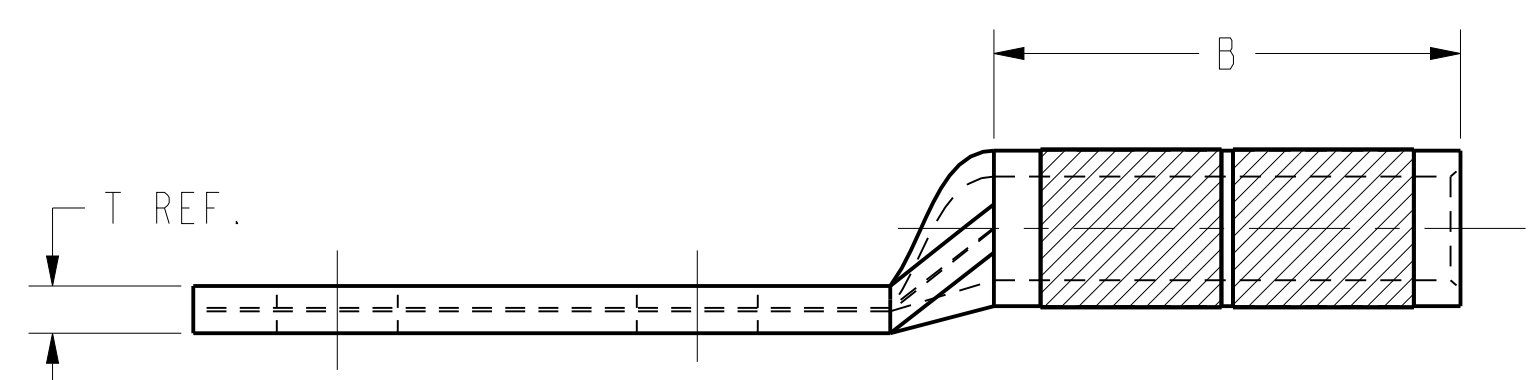
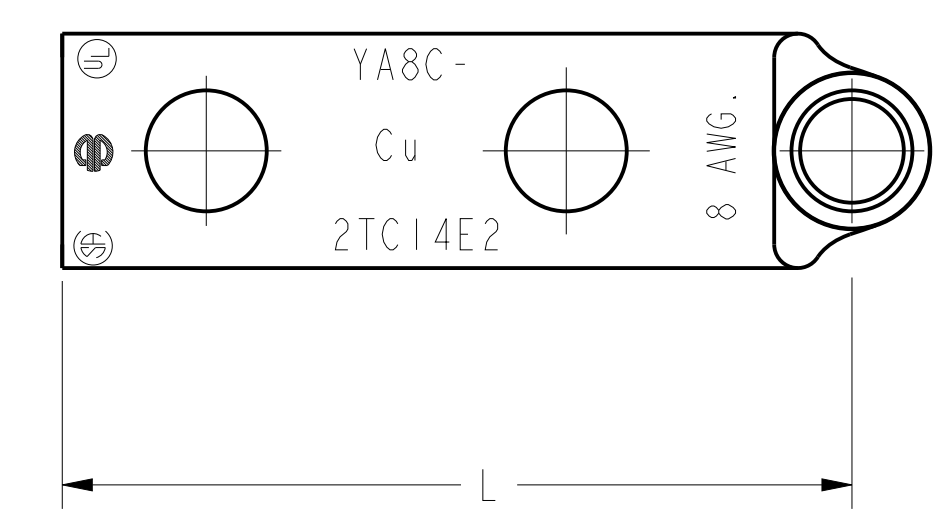
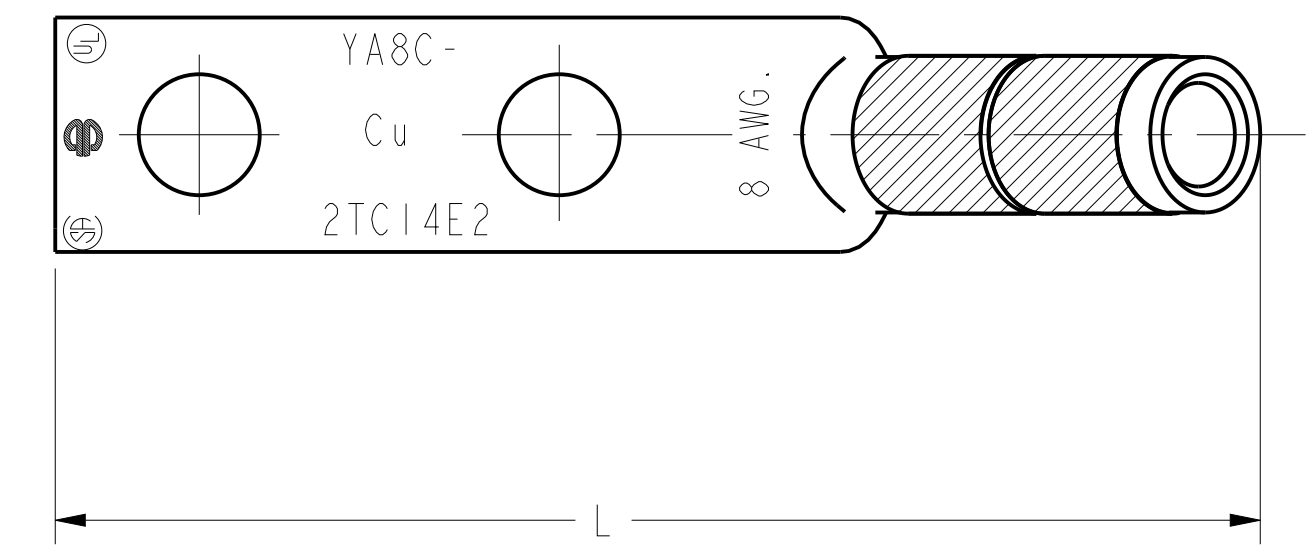
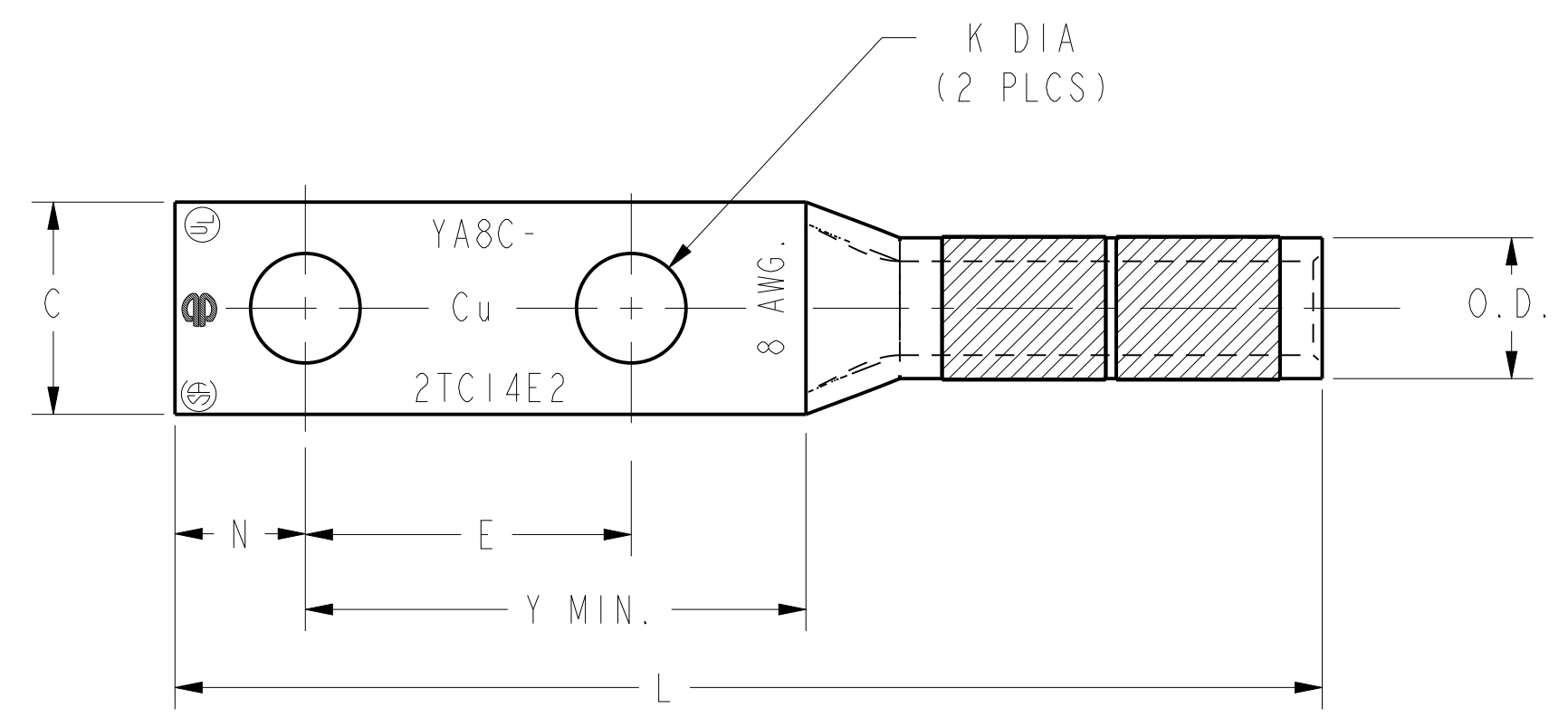



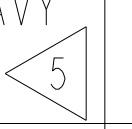
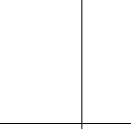
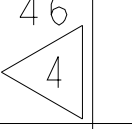
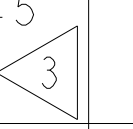
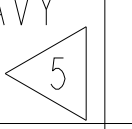
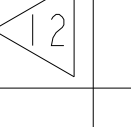
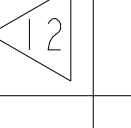
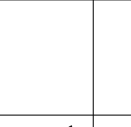
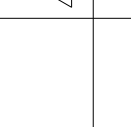
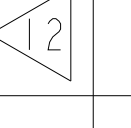
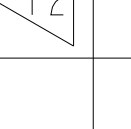

- NOTES:
1. MATERIAL : COPPER TUBING.
  2. FINISH: TIN PLATED.
  3. CATALOG # PT6515 ADAPTOR IS REQUIRED TO USE "U" DIES IN Y45 SERIES TOOLS.
  4. CATALOG # PUADP-1 ADAPTOR IS REQUIRED TO USE "U" DIES IN Y46 SERIES TOOLS.
  5. NAVY CABLE SIZE MAY BE OMITTED ON SOME SIZES BECAUSE OF SPACE LIMITATIONS.
  6. PERMANENT DIE IN TOOLING.
  7. DIMENSIONS IN BRACKETS [ ] ARE IN MILLIMETERS ROUNDED OFF TO THE NEAREST MILLIMETER, UNLESS OTHERWISE NOTED, AND ARE FOR REFERENCE ONLY.
  8. FOR USE BY CUSTOMERS THAT HAVE THIS HYPRESS™. NO NEW Y34 HYPRESSES™ TOOLS ARE BEING PROCESSED.
  9. OVERLAPPING CRIMPS ARE REQUIRED ON THESE SIZES.
  10. UL LISTED AND CSA CERTIFIED WIRE CONNECTORS.
  11. DO NOT USE PAT644 OR Y644 TOOLING WITH 6 AWG SOL.
  12. THESE CATALOG NUMBERS CANNOT BE INSTALLED WITH U8CRT DIE.
  13. THESE CATALOG NUMBERS CANNOT BE INSTALLED WITH Y45 OR Y46 TOOLING.
  14. THESE CATALOG NUMBERS CANNOT BE INSTALLED WITH Y45 TOOLING.
  15. USE SUFFIX "NK" FOR NICKEL PLATING.

TO ORDER BURNDY@PRODUCTS CALL		HYLUG™	
UNITED STATES: 1-800-346-4175 (LONDONDERRY, NH)		ITEM NO: N/A	SCALE: NTS
CANADA: 1-800-361-6975 (QUEBEC) 1-800-387-6487 (ALL OTHER PROVINCES)		CAT. NO: YA-2TC- (TABLE)	
FOR PRODUCT INFO: <a href="http://www.burndy.com">http://www.burndy.com</a>		DRAWN BY: J. MICHAUD 11/8/93	
		CHECKER: R. ROBICHEAU 1/10/94	
		DSN APPVL: C. PALAGI 1/12/94	
		MFG APPVL: N/A --	
		QA APPVL: A. LLOYD 1/24/94	
		MKT APPVL: G. GORDON 1/20/94	
		PROD FAM: CM&R COMPRESSION	
		PROJECT #: --	
		DOCUMENT TYPE: Sales	
		REL LEVEL: Released	
		DRAWING NO: SE208777	
		SHEET 1 OF 20	

REV: CREO 08/10/21

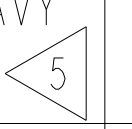
REV	DATE	DESCRIPTION	ECO	BY	C'H'K.
P	2023-06-30 01:00:00 EDT	UPDATED AS PER MARKUP	230627031427	YR	RA

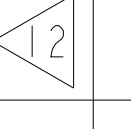
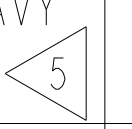
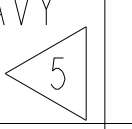
D	CATALOG NO.	FIG. NO.	CONDUCTOR		BOLT SIZE	DIMENSIONS								INSTALLATION TOOLING (# CRIMPS)								WIRE STRIP LENGTH																																																																																																																																																																																																																																																																																																								
			CODE (AWG)	NAVY 		B	C	E	H	K	L	N	O.D.	T REF.	Y MIN.	DIE INDEX	COLOR CODE	MECHANICAL			HYDRAULIC			DIELESS (# CRIMPS)																																																																																																																																																																																																																																																																																																						
						MD7-34R MD6	OUR840	Y8MRB-1 Y1MRTC Y122CMR	Y500CT PAT600	Y750,Y35 Y39, PAT750	Y46 PAT46 	Y45 																																																																																																																																																																																																																																																																																																																		
	YA8C2TC10	1	#8 STR #8 SOL #8 FLEX CLASS G, H, I, K, M DLO (37/24)  #6 SOL		#10 [M5]	.81 [21]	.41 [10]	.62 [16]	-	.21 [5]	2.20 [56]	.25 [6]	.27 [7]	.08 [2]	.90 [23]	49	RED	W8CRT (1) W8CVT (1)	X8CRT (1) W8CVT (1)	RED (2)	W8CRT (1) W8CVT (1)	U8CRT (1)	U8CRT (1)	U8CRT (1)	U8CRT (1)	MECHANICAL: MY29-11 (1)	7/8																																																																																																																																																																																																																																																																																																			
	YA8C2TC1045	2					#10 [M5]	.81 [21]	.41 [10]	.62 [16]	-	.21 [5]	2.20 [56]	.25 [6]	.27 [7]	.08 [2]	.90 [23]	49	RED	W8CRT (1) W8CVT (1)	X8CRT (1) W8CVT (1)	RED (2)	W8CRT (1) W8CVT (1)	U8CRT (1)	U8CRT (1)		U8CRT (1)	U8CRT (1)	MECHANICAL: MY29-11 (1)	7/8																																																																																																																																																																																																																																																																																																
	YA8C2TC1090 	3																														#10 [M5]	.81 [21]	.41 [10]	.62 [16]	-	.21 [5]	2.20 [56]	.25 [6]	.27 [7]	.08 [2]	.90 [23]	49	RED	W8CRT (1) W8CVT (1)	X8CRT (1) W8CVT (1)	RED (2)	W8CRT (1) W8CVT (1)	U8CRT (1)	U8CRT (1)	U8CRT (1)	U8CRT (1)	MECHANICAL: MY29-11 (1)	7/8																																																																																																																																																																																																																																																																								
	YA8C2TC14	1																																																						1/4 [M6]	.81 [21]	.41 [10]	.62 [16]	-	.21 [5]	2.20 [56]	.25 [6]	.27 [7]	.08 [2]	.90 [23]	49	RED	W8CRT (1) W8CVT (1)	X8CRT (1) W8CVT (1)	RED (2)	W8CRT (1) W8CVT (1)	U8CRT (1)	U8CRT (1)	U8CRT (1)	U8CRT (1)	MECHANICAL: MY29-11 (1)	7/8																																																																																																																																																																																																																																																
	YA8C2TC1445	2																																																																														1/4 [M6]	.81 [21]	.41 [10]	.62 [16]	-	.21 [5]	2.20 [56]	.25 [6]	.27 [7]	.08 [2]	.90 [23]	49	RED	W8CRT (1) W8CVT (1)	X8CRT (1) W8CVT (1)	RED (2)	W8CRT (1) W8CVT (1)	U8CRT (1)	U8CRT (1)	U8CRT (1)	U8CRT (1)	MECHANICAL: MY29-11 (1)	7/8																																																																																																																																																																																																																								
	YA8C2TC1490 	3																																																																																																						1/4 [M6]	.81 [21]	.41 [10]	.62 [16]	-	.21 [5]	2.20 [56]	.25 [6]	.27 [7]	.08 [2]	.90 [23]	49	RED	W8CRT (1) W8CVT (1)	X8CRT (1) W8CVT (1)	RED (2)	W8CRT (1) W8CVT (1)	U8CRT (1)	U8CRT (1)	U8CRT (1)	U8CRT (1)	MECHANICAL: MY29-11 (1)	7/8																																																																																																																																																																																																
	YA8C2TC14E2	1																																																																																																																														1/4 [M6]	.81 [21]	.41 [10]	.62 [16]	-	.21 [5]	2.20 [56]	.25 [6]	.27 [7]	.08 [2]	.90 [23]	49	RED	W8CRT (1) W8CVT (1)	X8CRT (1) W8CVT (1)	RED (2)	W8CRT (1) W8CVT (1)	U8CRT (1)	U8CRT (1)	U8CRT (1)	U8CRT (1)	MECHANICAL: MY29-11 (1)	7/8																																																																																																																																																																								
	YA8C2TC14E245	2																																																																																																																																																						1/4 [M6]	.81 [21]	.41 [10]	.62 [16]	-	.21 [5]	2.20 [56]	.25 [6]	.27 [7]	.08 [2]	.90 [23]	49	RED	W8CRT (1) W8CVT (1)	X8CRT (1) W8CVT (1)	RED (2)	W8CRT (1) W8CVT (1)	U8CRT (1)	U8CRT (1)	U8CRT (1)	U8CRT (1)	MECHANICAL: MY29-11 (1)	7/8																																																																																																																																																
	YA8C2TC14E290 	3																																																																																																																																																																														1/4 [M6]	.81 [21]	.41 [10]	.62 [16]	-	.21 [5]	2.20 [56]	.25 [6]	.27 [7]	.08 [2]	.90 [23]	49	RED	W8CRT (1) W8CVT (1)	X8CRT (1) W8CVT (1)	RED (2)	W8CRT (1) W8CVT (1)	U8CRT (1)	U8CRT (1)	U8CRT (1)	U8CRT (1)	MECHANICAL: MY29-11 (1)	7/8																																																																																																																								
	YA8C2TC14E1	1																																																																																																																																																																																																						1/4 [M6]	.81 [21]	.41 [10]	.62 [16]	-	.21 [5]	2.20 [56]	.25 [6]	.27 [7]	.08 [2]	.90 [23]	49	RED	W8CRT (1) W8CVT (1)	X8CRT (1) W8CVT (1)	RED (2)	W8CRT (1) W8CVT (1)	U8CRT (1)	U8CRT (1)	U8CRT (1)	U8CRT (1)	MECHANICAL: MY29-11 (1)	7/8																																																																																																
	YA8C2TC38	1																																																																																																																																																																																																																														3/8 [M10]	.81 [21]	.41 [10]	.62 [16]	-	.21 [5]	2.20 [56]	.25 [6]	.27 [7]	.08 [2]	.90 [23]	49	RED	W8CRT (1) W8CVT (1)	X8CRT (1) W8CVT (1)	RED (2)	W8CRT (1) W8CVT (1)	U8CRT (1)	U8CRT (1)	U8CRT (1)	U8CRT (1)	MECHANICAL: MY29-11 (1)	7/8																																																																								
	YA8C2TC38E16	1																																																																																																																																																																																																																																																						3/8 [M10]	.81 [21]	.41 [10]	.62 [16]	-	.21 [5]	2.20 [56]	.25 [6]	.27 [7]	.08 [2]	.90 [23]	49	RED	W8CRT (1) W8CVT (1)	X8CRT (1) W8CVT (1)	RED (2)	W8CRT (1) W8CVT (1)	U8CRT (1)	U8CRT (1)	U8CRT (1)	U8CRT (1)	MECHANICAL: MY29-11 (1)	7/8																																																
	YA8C2TC3845 	2																																																																																																																																																																																																																																																																														3/8 [M10]	.81 [21]	.41 [10]	.62 [16]	-	.21 [5]	2.20 [56]	.25 [6]	.27 [7]	.08 [2]	.90 [23]	49	RED	W8CRT (1) W8CVT (1)	X8CRT (1) W8CVT (1)	RED (2)	W8CRT (1) W8CVT (1)	U8CRT (1)	U8CRT (1)	U8CRT (1)	U8CRT (1)	MECHANICAL: MY29-11 (1)	7/8																								
	YA8C2TC3890	3																																																																																																																																																																																																																																																																																																						3/8 [M10]	.81 [21]	.41 [10]	.62 [16]	-	.21 [5]	2.20 [56]	.25 [6]	.27 [7]	.08 [2]	.90 [23]	49	RED	W8CRT (1) W8CVT (1)	X8CRT (1) W8CVT (1)	RED (2)	W8CRT (1) W8CVT (1)	U8CRT (1)	U8CRT (1)	U8CRT (1)	U8CRT (1)	MECHANICAL: MY29-11 (1)	7/8

SEE SHEET 1 OF 20 FOR VIEWS AND NOTE.

REV: CREO 08/10/21

TO ORDER BURNDY@PRODUCTS CALL		HULLUG™	
UNITED STATES: 1-800-346-4175 (LONDONDERRY, NH)		ITEM NO: N/A	
CANADA: 1-800-361-6975 (QUEBEC) 1-800-387-6487 (ALL OTHER PROVINCES)		CAT. NO: YA-2TC- (TABLE)	
FOR PRODUCT INFO: <a href="http://www.burndy.com">http://www.burndy.com</a>		DRAWN BY: J. MICHAUD 11/8/93	
		CHECKER: R. ROBICHEAU 1/10/94	
		DSN APPVL: C. PALAGI 1/12/94	
		MFG APPVL: N/A --	
		QA APPVL: A. LLOYD 1/24/94	
		MKT APPVL: G. GORDON 1/20/94	
		SCALE: NTS	
		PROD FAM: CM&R COMPRESSION	
		DRAWING NO	
		PROJECT #: --	
		SIZE	
		DOCUMENT TYPE: Sales	
		REL LEVEL: Released	
		SE208777	
		P	
		SHEET 2 OF 20	

CATALOG NO.	FIG. NO.	CONDUCTOR		BOLT SIZE	DIMENSIONS									INSTALLATION TOOLING (# CRIMPS)												
		CODE (AWG)	NAVY		B	C	E	H	K	L	N	O.D.	T REF.	Y MIN.	DIE INDEX	COLOR CODE	MECHANICAL			HYDRAULIC				DIELESS (# CRIMPS)	WIRE STRIP LENGTH	
																	MD7-34R MD6	OUR840	YIMRTC 6 Y122CMR	BCT500 Y500CT	Y34A 8	Y750,PAT750 Y35, Y39	Y46 4			Y45 3
YA6C2TC10	1	#6 STR	30	#10 [M5]	1.12 [28]	.42 [11]	.62 [16]	-	.21 [5]	2.53 [64]	.25 [6]	.29 [7]	.09 [2]	.90 [23]	7 OR 374	BLUE	W5CVT W5CRT (2)	W5CVT W5CRT (2)	BLUE (2)	W5CVT W5CRT (2)	A5CR (2)	U8CABT U5CRT (2)	U8CABT U5CRT (2)	U8CABT U5CRT (2)		1-3/16
YA6C2TC1045	2	#6 SOL		#10 [M5]						2.35 [60]																
YA6C2TC1090	3			#10 [M5]						1.40 [36]																
YA6C2TC10E2	1			#10 [M5]						-																
YA6C2TC10E245	2			#10 [M5]		.42 [11]	.75 [19]	1.19 [30]	.21 [5]	2.48 [63]	.25 [6]	.09 [2]	1.03 [26]													
YA6C2TC10E290	3			#10 [M5]				1.52 [39]		1.51 [38]																
YA6C2TC14	1			1/4 [M6]		.45 [11]	.62 [16]	1.19 [30]	.27 [7]	2.45 [62]	.31 [8]	.08 [2]	.96 [24]													
YA6C2TC1445	2			1/4 [M6]				1.50 [38]		1.51 [38]																
YA6C2TC1490	3			1/4 [M6]				-		3.03 [77]																
YA6C2TC14E1	1			1/4 [M6]		.45 [11]	1.00 [25]	1.19 [30]	.27 [7]	2.83 [72]	.31 [8]	.08 [2]	1.34 [34]													
YA6C2TC14E145	2			1/4 [M6]				1.50 [38]		1.88 [48]																
YA6C2TC14E190	3			1/4 [M6]		.45 [11]	.75 [19]	1.19 [30]	.27 [7]	2.58 [66]	.31 [8]	.08 [2]	1.09 [28]													
YA6C2TC14E2	1			1/4 [M6]				-		2.78 [71]																
YA6C2TC14E245	2			1/4 [M6]		.45 [11]	.75 [19]	1.19 [30]	.27 [7]	2.58 [66]	.31 [8]	.08 [2]	1.09 [28]													
YA6C2TC14E290	3			1/4 [M6]				1.50 [38]		1.63 [41]																
YA6C2TC516E6	1			5/16 [M8]		.52 [13]	.88 [22]	1.18 [30]	.33 [8]	2.72 [69]	.34 [9]	.07 [2]	1.24 [31]													
YA6C2TC516E645	2			5/16 [M8]				1.48 [38]		1.81 [46]																
YA6C2TC516E690	3			5/16 [M8]				-		3.22 [82]																
YA6C2TC38	1			3/8 [M10]		.58 [15]	1.00 [25]	1.18 [30]	.41 [10]	2.97 [75]	.41 [10]	.06 [2]	1.43 [36]													
YA6C2TC3845	2			3/8 [M10]				1.46 [37]		2.06 [52]																
YA6C2TC3890	3			3/8 [M10]				-		2.97 [75]																
YA6C2TC38E2	1			3/8 [M10]		.75 [19]	1.18 [30]	1.18 [30]		2.72 [69]			1.18 [30]													
YA6C2TC38E245	2			3/8 [M10]				1.46 [37]		1.81 [46]																
YA6C2TC38E290	3			3/8 [M10]				-		3.09 [78]																
YA6C2TC38E6	1			3/8 [M10]		.88 [22]	1.18 [30]	1.18 [30]		2.85 [72]			1.31 [33]													
YA6C2TC38E645	2			3/8 [M10]				1.46 [37]		1.94 [49]																
YA6C2TC38E690	3			3/8 [M10]				-		3.03 [77]																
YA6C2TC38E13	1	#6 STR	30	3/8 [M10]	1.12 [28]	.58 [15]	.81 [21]	1.18 [30]	.41 [10]	2.78 [71]	.41 [10]	.29 [7]	.06 [2]	1.24 [31]	7 OR 374	BLUE	W5CVT W5CRT (2)	W5CVT W5CRT (2)	BLUE (2)	W5CVT W5CRT (2)	A5CR (2)	U8CABT U5CRT (2)	U8CABT U5CRT (2)	U8CABT U5CRT (2)		1-3/16
YA6C2TC38E1345	2	#6 SOL		3/8 [M10]				1.46 [37]		1.87 [47]																
YA6C2TC38E1390	3			3/8 [M10]				-		3.03 [77]																

SEE SHEET 1 OF 20 FOR VIEWS AND NOTES

REV	DATE	DESCRIPTION	ECO	BY	C'K'	
	P	2023-06-30 01:00:00 EDT	UPDATED AS PER MARKUP	230627031427	YR	RA
	TO ORDER BURNDY@PRODUCTS CALL UNITED STATES: 1-800-346-4175 (LONDONDERRY, NH) CANADA: 1-800-361-6975 (QUEBEC) 1-800-387-6487 (ALL OTHER PROVINCES) FOR PRODUCT INFO: <a href="http://www.burndy.com">http://www.burndy.com</a>					
	HYLUG™ ITEM NO: N/A CAT. NO: YA-2TC- (TABLE) DRAWN BY: J. MICHAUD 11/8/93 CHECKER: R. ROBICHEAU 1/10/94 DSN APPVL: C. PALAGI 1/12/94 MFG APPVL: N/A -- QA APPVL: A. LLOYD 1/24/94 MKT APPVL: G. GORDON 1/10/94 PROD FAM: CM&R COMPRESSION DRAWING NO: SE208777 PROJECT #: -- DOCUMENT TYPE: Sales REL LEVEL: Released SCALE: NTS SHEET 3 OF 20					

REV: CREO 08/10/21



REV	DATE	DESCRIPTION	ECO	BY	CHK.
P	2023-06-30 01:00:00 EDT	UPDATED AS PER MARKUP	230627031427	YR	RA

D	CATALOG NO.	FIG. NO.	CONDUCTOR		BOLT SIZE	DIMENSIONS								INSTALLATION TOOLING (# CRIMPS)												
			CODE (AWG)	NAVY		B	C	E	H	K	L	N	O.D.	T REF.	Y MIN.	DIE INDEX	COLOR CODE	MECHANICAL			HYDRAULIC				DIELESS (# CRIMPS)	WIRE STRIP LENGTH
																		MD7-34R MD6	OUR840	Y1MRTG Y122CMR	BCT500 Y500CT	Y34A	Y750, Y35 Y39 PAT750	Y46		
	YA4C2TC10	1	#4 AWG	40	#10	1.12 [28]	.50 [13]	.62 [16]	-	.21 [5]	2.58 [66]	.34 [9]	.09 [2]	.90 [23]	8 OR 346	GRAY	W4CVT W4CRT (2)	W4CVT W4CRT (2)	GRAY (4)	W4CVT W4CRT (2)	A6CAB A4CR (2)	U6CABT U4CRT (2)	U6CABT U4CRT (2)	U6CABT U4CRT (2)	MECHANICAL: MY29-11 (1) HYDRAULIC: Y644, Y644M Y644MBH, BAT644M, PAT644M, Y1000 Y1000BH (1)	1-3/16
	YA4C2TC1045	2			[M5]																					
	YA4C2TC1090	3																								
	YA4C2TC14	1																								
	YA4C2TC1445	2																								
	YA4C2TC1490	3																								
	YA4C2TC14E2	1																								
C	YA4C2TC14E245	2																								
	YA4C2TC14E290	3																								
	YA4C2TC14E1	1																								
	YA4C2TC14E145	2																								
	YA4C2TC14E190	3																								
	YA4C2TC38	1																								
	YA4C2TC3845	2																								
	YA4C2TC3890	3	#4 AWG	40	[M8]	1.12 [28]	.58 [15]	1.00 [25]	-	.40 [10]	3.26 [83]	.34 [9]	.08 [2]	1.43 [36]	8 OR 346	GRAY	W4CVT W4CRT (2)	W4CVT W4CRT (2)	GRAY (4)	W4CVT W4CRT (2)	A6CAB A4CR (2)	U6CABT U4CRT (2)	U6CABT U4CRT (2)	U6CABT U4CRT (2)	1-3/16	

B

B

A

A

SEE SHEET 1 OF 20 FOR VIEWS & NOTES

TO ORDER BURNDY@PRODUCTS CALL		HYLUG™	
UNITED STATES: 1-800-346-4175 (LONDONDERRY, NH)		ITEM NO: N/A	
CANADA: 1-800-361-6975 (QUEBEC) 1-800-387-6487 (ALL OTHER PROVINCES)		CAT. NO: YA4C-2TC- (TABLE)	
FOR PRODUCT INFO: <a href="http://www.burndy.com">http://www.burndy.com</a>		DRAWN BY: J. MICHAUD 11/8/93	
		CHECKER: R. ROBICHEAU 1/10/94	
		DSN APPVL: C. PALAGI 1/12/94	
		MFG APPVL: N/A --	
		QA APPVL: A. LLOYD 1/24/94	
		MKT APPVL: G. GORDON 1/10/94	
		SCALE: NTS	
		PROD. FAM: CM&R COMPRESSION	
		DRAWING NO	
		PROJECT #: --	
		SIZE	
		DOCUMENT TYPE: Sales	
		REL LEVEL: Released	
		SE208777	
		P	
		SHEET 4 OF 20	

REV: CREO\_08/10/21

REV	DATE	DESCRIPTION	ECO	BY	C.H.K.
P	2023-06-30 01:00:00 EDT	UPDATED AS PER MARKUP	230627031427	YR	RA

D	CATALOG NO.	FIG. NO.	CONDUCTOR			BOLT SIZE	METRIC BOLT SIZE	DIMENSIONS								INSTALLATION TOOLING (# CRIMPS)													
			CODE (AWG)	NAVY	METRIC			B	C	E	H	K	L	N	O.D.	T REF.	Y MIN.	DIE INDEX	COLOR CODE	MECHANICAL			HYDRAULIC				DIELESS (# CRIMPS)	WIRE STRIP LENGTH	
																				MD7-34R MD6	OUR840	YIMRTC Y122CMR	BCT500 Y500CT	Y34A	Y750, Y35 Y39	Y46			Y45
	YA3C2TC38E2	1	#2 SOL #3 AWG	50	25mm <sup>2</sup>	3/8	----	1.25 [32]	.58 [15]	.75 [19]	-	.40 [10]	3.18 [81]	.41 [10]	.38 [10]	.08 [2]	1.18 [30]	9	WHITE	W3CRT (2)	W3CRT (2)	WHITE (4)	W3CRT (2)	A3CR (2)	U3CRT (2)	U3CRT (2)	U3CRT (2)	MECHANICAL: MY29-11(1)  HYDRAULIC: Y644, Y644M Y644MBH, BAT644M  Y1000 Y1000BH(1)	1-5/16
	YA3C2TC38E245	2				3/8	----	1.25 [32]	.58 [15]	.75 [19]	1.40 [36]	.40 [10]	3.43 [87]	.41 [10]	.38 [10]	.08 [2]	1.18 [30]	9	WHITE	W3CRT (2)	W3CRT (2)	WHITE (4)	W3CRT (2)	A3CR (2)	U3CRT (2)	U3CRT (2)	U3CRT (2)		
	YA3C2TC38E290	3				3/8	----	1.25 [32]	.58 [15]	.75 [19]	1.72 [44]	.40 [10]	3.43 [87]	.41 [10]	.38 [10]	.08 [2]	1.18 [30]	9	WHITE	W3CRT (2)	W3CRT (2)	WHITE (4)	W3CRT (2)	A3CR (2)	U3CRT (2)	U3CRT (2)	U3CRT (2)		
	YA3C2TC38	1				3/8	----	1.25 [32]	.58 [15]	.75 [19]	-	.40 [10]	3.16 [80]	.41 [10]	.38 [10]	.08 [2]	1.43 [36]	9	WHITE	W3CRT (2)	W3CRT (2)	WHITE (4)	W3CRT (2)	A3CR (2)	U3CRT (2)	U3CRT (2)	U3CRT (2)		
	YA3C2TC3845	2				3/8	----	1.25 [32]	.58 [15]	.75 [19]	1.40 [36]	.40 [10]	3.16 [80]	.41 [10]	.38 [10]	.08 [2]	1.43 [36]	9	WHITE	W3CRT (2)	W3CRT (2)	WHITE (4)	W3CRT (2)	A3CR (2)	U3CRT (2)	U3CRT (2)	U3CRT (2)		
	YA3C2TC3890	3				3/8	----	1.25 [32]	.58 [15]	.75 [19]	1.72 [44]	.40 [10]	3.16 [80]	.41 [10]	.38 [10]	.08 [2]	1.43 [36]	9	WHITE	W3CRT (2)	W3CRT (2)	WHITE (4)	W3CRT (2)	A3CR (2)	U3CRT (2)	U3CRT (2)	U3CRT (2)		
	YA3C2TC14	1				1/4	M6	1.25 [32]	.55 [14]	.62 [16]	-	.27 [7]	2.87 [73]	.31 [8]	.38 [10]	.09 [2]	.96 [24]	9	WHITE	W3CRT (2)	W3CRT (2)	WHITE (4)	W3CRT (2)	A3CR (2)	U3CRT (2)	U3CRT (2)	U3CRT (2)		
	YA3C2TC1445	2				1/4	M6	1.25 [32]	.55 [14]	.62 [16]	1.40 [36]	.27 [7]	2.62 [67]	.31 [8]	.38 [10]	.09 [2]	.96 [24]	9	WHITE	W3CRT (2)	W3CRT (2)	WHITE (4)	W3CRT (2)	A3CR (2)	U3CRT (2)	U3CRT (2)	U3CRT (2)		
	YA3C2TC1490	3				1/4	M6	1.25 [32]	.55 [14]	.62 [16]	1.73 [44]	.27 [7]	2.62 [67]	.31 [8]	.38 [10]	.09 [2]	.96 [24]	9	WHITE	W3CRT (2)	W3CRT (2)	WHITE (4)	W3CRT (2)	A3CR (2)	U3CRT (2)	U3CRT (2)	U3CRT (2)		
	YA3C2TC14E2	1				1/4	M6	1.25 [32]	.55 [14]	.75 [19]	-	.27 [7]	2.99 [76]	.31 [8]	.38 [10]	.09 [2]	1.09 [28]	9	WHITE	W3CRT (2)	W3CRT (2)	WHITE (4)	W3CRT (2)	A3CR (2)	U3CRT (2)	U3CRT (2)	U3CRT (2)		
	YA3C2TC14E245	2				1/4	M6	1.25 [32]	.55 [14]	.75 [19]	1.40 [36]	.27 [7]	2.75 [70]	.31 [8]	.38 [10]	.09 [2]	1.09 [28]	9	WHITE	W3CRT (2)	W3CRT (2)	WHITE (4)	W3CRT (2)	A3CR (2)	U3CRT (2)	U3CRT (2)	U3CRT (2)		
	YA3C2TC14E290	3				1/4	M6	1.25 [32]	.55 [14]	.75 [19]	1.73 [44]	.27 [7]	2.75 [70]	.31 [8]	.38 [10]	.09 [2]	1.09 [28]	9	WHITE	W3CRT (2)	W3CRT (2)	WHITE (4)	W3CRT (2)	A3CR (2)	U3CRT (2)	U3CRT (2)	U3CRT (2)		
	YA3C2TC14E1	1	1/4	M6	1.25 [32]	.55 [14]	1.00 [25]	-	.27 [7]	3.24 [82]	.31 [8]	.38 [10]	.09 [2]	1.34 [34]	9	WHITE	W3CRT (2)	W3CRT (2)	WHITE (4)	W3CRT (2)	A3CR (2)	U3CRT (2)	U3CRT (2)	U3CRT (2)					
	YA3C2TC14E145	2	1/4	M6	1.25 [32]	.55 [14]	1.00 [25]	1.40 [36]	.27 [7]	3.00 [76]	.31 [8]	.38 [10]	.09 [2]	1.34 [34]	9	WHITE	W3CRT (2)	W3CRT (2)	WHITE (4)	W3CRT (2)	A3CR (2)	U3CRT (2)	U3CRT (2)	U3CRT (2)					
	YA3C2TC14E190	3	1/4	M6	1.25 [32]	.55 [14]	1.00 [25]	1.73 [44]	.27 [7]	3.00 [76]	.31 [8]	.38 [10]	.09 [2]	1.34 [34]	9	WHITE	W3CRT (2)	W3CRT (2)	WHITE (4)	W3CRT (2)	A3CR (2)	U3CRT (2)	U3CRT (2)	U3CRT (2)					

SEE SHEET 1 OF 20 FOR VIEWS AND NOTES

NOTE :

NOT FOR USE ON #2 SOL CONDUCTOR.

REV: CREO\_08/10/21

TO ORDER BURNDY@PRODUCTS CALL		HYLUG™	
UNITED STATES: 1-800-346-4175 (LONDONDERRY, NH)		ITEM NO: N/A	CAT. NO: YA-2TC- (TABLE)
CANADA: 1-800-361-6975 (QUEBEC) 1-800-387-6487 (ALL OTHER PROVINCES)		DRAWN BY: J.MICHAUD 11/8/93	CHECKER: R.ROBICHEAU 1/10/94
FOR PRODUCT INFO: <a href="http://www.burndy.com">http://www.burndy.com</a>		DSN APPVL: C.PALAGI 1/12/94	MFG APPVL: N/A --
		QA APPVL: A.LLOYD 1/24/94	MKT APPVL: G.GORDON 1/20/94
		SCALE: NTS	
		PROD FAM: CM&R COMPRESSION	DRAWING NO
		PROJECT #: --	SIZE
		DOCUMENT TYPE: Sales	SE208777
		REL LEVEL: Released	D
		SHEET 5 OF 20	



CATALOG NO.	FIG. NO.	CONDUCTOR		BOLT SIZE	DIMENSIONS									INSTALLATION TOOLING (# CRIMPS)																						
		CODE (AWG)	NAVY		B	C	E	H	K	L	N	O.D.	T REF.	Y MIN.	DIE INDEX	COLOR CODE	MECHANICAL			HYDRAULIC				DIELESS (# CRIMPS)	WIRE STRIP LENGTH											
																	MD7-34R MD6	OUR840	YIMRTC Y122CMR	Y34A	BCT500 Y500CT PAT600	Y750, Y35 Y39, PAT750	Y46			Y45										
YA2C2TC10	1	#2 AWG	60	#10 [5]	1.25 [32]	.60 [15]	.62 [16]	-	.21	2.74 [70]	.42 [11]	.11 [3]	.90 [23]	10	BROWN	W2CVT W2CRT (2)	W2CVT W2CRT (2)	BROWN (4)	A2CR (2)	W2CVT W2CRT (2)	U2CRT (2)	U2CRT (2)	U2CRT (2)		1-5/16											
YA2C2TC1045	2							1.31 [33]	.25	2.53 [64]																1.46 [37]	.27	.31	2.66 [68]	1.58 [40]	.96 [24]					
YA2C2TC1090	3							1.63 [41]	.27	2.86 [73]																1.76 [45]	.27	.31	2.66 [68]	1.58 [40]	.96 [24]					
YA2C2NT14	1							1/4 [6]	.48 [12]	.62 [16]																1.43 [36]	.27 [7]	.31 [8]	2.66 [68]	1.58 [40]	.96 [24]					
YA2C2NT1445	2																															1.43 [36]	.27	.31	2.66 [68]	1.58 [40]
YA2C2NT1490	3																															1.76 [45]	.27	.31	2.66 [68]	1.58 [40]
YA2C2TC14	1							1/4 [6]	.60 [15]	.62 [16]																1.43 [36]	.27 [7]	.31 [8]	2.66 [68]	1.58 [40]	.96 [24]					
YA2C2TC1445	2																															1.43 [36]	.27	.31	2.66 [68]	1.58 [40]
YA2C2TC1490	3																															1.76 [45]	.27	.31	2.66 [68]	1.58 [40]
YA2C2TC14E2	1							1/4 [6]	.75 [19]	.75 [16]																1.43 [36]	.27 [7]	.31 [8]	2.78 [71]	1.71 [43]	1.09 [28]					
YA2C2TC14E245	2																															1.43 [36]	.27	.31	2.78 [71]	1.71 [43]
YA2C2TC14E290	3																															1.76 [45]	.27	.31	2.78 [71]	1.71 [43]
YA2C2TC38E2	1							3/8 [10]	.75 [19]	.75 [16]																1.43 [36]	.40 [10]	.41 [10]	2.97 [75]	1.90 [48]	1.18 [30]					
YA2C2TC38E245	2																															1.43 [36]	.40	.41	2.97 [75]	1.90 [48]
YA2C2TC38E290	3																															1.76 [45]	.40	.41	2.97 [75]	1.90 [48]
YA2C2TC516E2	1	5/16 [8]	.75 [19]	.75 [16]	1.43 [36]	.33 [8]	.34 [9]	3.05 [77]	1.77 [45]	1.12 [28]																										
YA2C2TC516E245	2										1.43 [36]	.33	.34	3.05 [77]	1.77 [45]																					
YA2C2TC516E290	3										1.76 [45]	.33	.34	3.05 [77]	1.77 [45]																					
YA2C2TC38E6	1	3/8 [10]	.88 [22]	.88 [16]	1.43 [36]	.40 [10]	.41 [10]	3.10 [79]	2.02 [51]	1.31 [33]																										
YA2C2TC38E645	2										1.43 [36]	.40	.41	3.10 [79]	2.02 [51]																					
YA2C2TC38E690	3										1.76 [45]	.40	.41	3.10 [79]	2.02 [51]																					
YA2C2TC38	1	3/8 [10]	1.00 [25]	1.00 [16]	1.43 [36]	.40 [10]	.41 [10]	3.42 [87]	2.14 [54]	1.43 [36]																										
YA2C2TC3845	2										1.43 [36]	.40	.41	3.42 [87]	2.14 [54]																					
YA2C2TC3890	3										1.76 [45]	.40	.41	3.42 [87]	2.14 [54]																					
YA2C2NTC38	1	3/8 [10]	1.75 [44]	1.75 [16]	1.43 [36]	.40 [10]	.41 [10]	4.17 [106]	3.97 [101]	2.18 [55]																										
YA2C2NTC3845	2										1.43 [36]	.40	.41	4.17 [106]	3.97 [101]																					
YA2C2NTC3890	3										1.76 [45]	.40	.41	4.17 [106]	3.97 [101]																					
YA2C2TC14E1	1	#2 AWG	60	1/4 [6]	1.25 [32]	.60 [15]	1.00 [25]	1.43 [36]	.27 [7]	3.03 [77]	.42 [11]	.11 [3]	1.34 [34]	10	BROWN	W2CVT W2CRT (2)	W2CVT W2CRT (2)	BROWN (4)	A2CR (2)	W2CVT W2CRT (2)	U2CRT (2)	U2CRT (2)	U2CRT (2)		1-5/16											
YA2C2TC14E145	2																									1.43 [36]	.27	.31	3.03 [77]	1.96 [50]						
YA2C2TC14E190	3																									1.76 [45]	.27	.31	3.03 [77]	1.96 [50]						

SEE SHEET 1 OF 20 FOR VIEWS AND NOTES

TO ORDER BURNDY@PRODUCTS CALL  
 UNITED STATES:  
 1-800-346-4175 (LONDONDERRY, NH)  
 CANADA:  
 1-800-361-6975 (QUEBEC)  
 1-800-387-6487 (ALL OTHER PROVINCES)  
 FOR PRODUCT INFO: <http://www.burndy.com>

REV		DATE	DESCRIPTION	ECO	BY	C'K'
P		2023-06-30 01:00:00 EDT	UPDATED AS PER MARKUP	230627031427	YR	RA

ITEM NO: N/A		HULUG™	
CAT. NO: YA2C-2TC & YA2C-2NT-			
DRAWN BY: J. MICHARD	11/8/93		
CHECKER: R. ROBICHEAU	1/10/94		
DSN APPVL: C. PALAGI	1/12/94		
MFG APPVL: N/A	--		
QA APPVL: A. LLOYD	1/24/94		
MKT APPVL: G. GORDON	1/20/94	SCALE: NTS	
PROD FAM: CM&R COMPRESSION	DRAWING NO	SE208777	REV
PROJECT #: --	SIZE	D	P
DOCUMENT TYPE: Sales	SHEET 6 OF 20		
REL LEVEL: Released			

REV: CREO\_08/10/21

REV	DATE	DESCRIPTION	ECO	BY	C'H'K.
P	2023-06-30 01:00:00 EDT	UPDATED AS PER MARKUP	230627031427	YR	RA

D	CATALOG NO.	FIG. NO.	CONDUCTOR		BOLT SIZE	DIMENSIONS									INSTALLATION TOOLING (# CRIMPS)																	
			CODE (AWG)	NAVY		B	C	E	H	K	L	N	O.D.	T REF.	Y MIN.	DIE INDEX	COLOR CODE	MECHANICAL			HYDRAULIC				DIELESS (# CRIMPS)	WIRE STRIP LENGTH						
																		MD7-34R MD6	OUR840	YIMRTC	BCT500 Y500CT	Y34A	Y750, Y35 Y39	Y46			Y45					
	YAIC2TC14	1	#1 AWG	75	1/4	1.38 [35]	.67 [17]	.62 [16]	-	.27 [7]	3.03 [77]	.31 [8]	.46 [12]	.10 [3]	.96 [24]	11 OR 375	GREEN	WICVT WICRT (2)	WICVT WICRT (2)	GREEN (4)	WICVT WICRT (2)	A4CAB AICR (2)	U4CABT UICRT (2)	U4CABT UICRT (2)	U4CABT UICRT (2)	MECHANICAL: MY29-11 (1)  HYDRAULIC: Y644, Y644M, Y644MBH, BAT644M, Y1000, Y1000BH (1)	1-7/16					
	YAIC2TC1445	2				1.58 [40]	2.76 [70]	2.76 [70]	1.09 [28]																							
	YAIC2TC1490	3				1.91 [49]	1.60 [41]	1.60 [41]																								
	YAIC2TC14E2	1				1/4	1.38 [35]	.67 [17]	.75 [19]	-	.27 [7]	3.15 [80]	.31 [8]	1.09 [28]																		
	YAIC2TC14E245	2					1.58 [40]	2.88 [73]	2.88 [73]																							
	YAIC2TC14E290	3					1.91 [49]	1.73 [44]	1.73 [44]																							
	YAIC2TC14E1	1			1/4		1.38 [35]	.67 [17]	1.00 [25]	-	.27 [7]	3.40 [86]	.31 [8]	1.34 [34]																		
	YAIC2TC14E145	2					1.58 [40]	3.14 [80]	3.14 [80]																							
	YAIC2TC14E190	3					1.91 [49]	1.98 [50]	1.98 [50]																							
	YAIC2TC38	1				3/8	1.38 [35]	.67 [17]	1.00 [25]	-	.40 [10]	3.59 [91]	.41 [10]	1.43 [36]																		
	YAIC2TC38E16	1					1.75 [44]	4.34 [110]	4.34 [110]																							
	YAIC2TC3845	2					1.00 [25]	3.32 [84]	3.32 [84]																							
	YAIC2TC3890	3			1.00 [25]		2.16 [55]	2.16 [55]																								

C

B

A

SEE SHEET 1 OF 20 FOR VIEWS AND NOTES

REV: CREO\_08/10/21

TO ORDER BURNDY@PRODUCTS CALL		HYLUG™	
UNITED STATES: 1-800-346-4175 (LONDONDERRY, NH)		ITEM NO: N/A	CAT. NO: YAIC-2TC- (TABLE)
CANADA: 1-800-361-6975 (QUEBEC) 1-800-387-6487 (ALL OTHER PROVINCES)		DRAWN BY: J. MICHAUD 11/8/93	CHECKER: R. ROBICHEAU 1/10/94
FOR PRODUCT INFO: <a href="http://www.burndy.com">http://www.burndy.com</a>		DSN APPVL: C. PALAGI 1/12/94	MFG APPVL: N/A --
		QA APPVL: A. LLOYD 1/24/94	MKT APPVL: G. GORDON 1/20/94
		SCALE: NTS	
		PROD FAM: CM&R COMPRESSION	DRAWING NO: SE208777
		PROJECT #: --	REV: P
		DOCUMENT TYPE: Sales	SHEET 7 OF 20
		REL LEVEL: Released	

REV	DATE	DESCRIPTION	ECO	BY	C'H'K.
P	2023-06-30 01:00:00 EDT	UPDATED AS PER MARKUP	230627031427	YR	RA

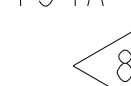
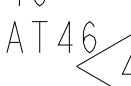
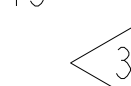
CATALOG NO.	FIG. NO.	CONDUCTOR		BOLT SIZE	DIMENSIONS									INSTALLATION TOOLING (# CRIMPS)																										
		CODE (AWG)	NAVY 		B	C	E	H	K	L	N	O.D.	T REF.	Y MIN.	DIE INDEX	COLOR CODE	MECHANICAL		HYDRAULIC				DIELESS (# CRIMPS)	WIRE STRIP LENGTH																
																	MD7-34R MD6	OUR840	Y500CT PAT600	Y34A 	Y750, Y35 Y39, PAT750	Y46 PAT46 			Y45 															
YA252TC14	1	1/0 AWG	100	1/4	1.38 [32]	.75 [15]	.62 [16]	-	.27 [7]	3.05 [77]	.31 [8]	.51 [13]	.12 [3]	.96 [24]	12 OR 348	PINK	W25VT W25RT (4)	W25VT W25RT (4)	W25VT W25RT (4)	A2CAB A25R (2)	U2CABT U25RT (2)	U2CABT U25RT (2)	U2CABT U25RT (2)	MECHANICAL: MY29-3 (2) MY29-11 (2)  HYDRAULIC: MRC840 (4) Y644HS (1) Y81KFT (2) Y81KFTMBH (2) PAT81KFT-18V (2)	1-7/16															
YA252TC1445	2							1.64 [42]		2.82 [72]							3.18 [81]	2.94 [75]	3.38 [86]	2.20 [56]	4.37 [111]	3.26 [83]	3.43 [87]																	
YA252TC1490	3							1.97 [50]		1.64 [42]							1.97 [50]	1.64 [42]	1.97 [50]	1.64 [42]	1.97 [50]	1.64 [42]	1.97 [50]																	
YA252TC14E2	1							1/4		.75 [19]							.27 [7]	3.18 [81]	.31 [8]	.51 [13]	.12 [3]	1.09 [28]	1.43 [36]																	
YA252TC14E245	2																									1.64 [42]	2.94 [75]	3.38 [86]	2.20 [56]	4.37 [111]	3.26 [83]	3.43 [87]								
YA252TC14E290	3																									1.97 [50]	1.64 [42]	1.97 [50]	1.64 [42]	1.97 [50]	1.64 [42]	1.97 [50]	1.64 [42]	1.97 [50]						
YA252TC38	1							3/8		1.00 [25]							.40 [10]	3.62 [92]	.41 [10]	.51 [13]	.12 [3]	1.43 [36]	2.18 [55]																	
YA252TC3845	2																									1.64 [42]	3.38 [86]	2.20 [56]	4.37 [111]	3.26 [83]	3.43 [87]									
YA252TC3890	3																									1.97 [50]	1.64 [42]	1.97 [50]	1.64 [42]	1.97 [50]	1.64 [42]	1.97 [50]	1.64 [42]	1.97 [50]						
YA252NTC38	1																									3/8	1.75 [44]	.40 [10]	4.37 [111]	.41 [10]	.51 [13]	.12 [3]	2.18 [55]	1.37 [35]						
YA252NTC3845	2																																		1.64 [42]	4.13 [105]	2.95 [75]	3.49 [89]	3.26 [83]	3.43 [87]
YA252NTC3890	3																																		1.97 [50]	1.64 [42]	1.97 [50]	1.64 [42]	1.97 [50]	1.64 [42]
YA252TC516	1							5/16		1.00 [25]							.33 [8]	3.49 [89]	.34 [9]	.51 [13]	.12 [3]	1.37 [35]	1.38 [35]																	
YA252TC51645	2																									1.64 [42]	3.26 [83]	2.08 [53]	3.49 [89]	3.26 [83]	3.43 [87]									
YA252TC51690	3																									1.97 [50]	1.64 [42]	1.97 [50]	1.64 [42]	1.97 [50]	1.64 [42]	1.97 [50]	1.64 [42]	1.97 [50]						
YA252TC14E1	1							1/4		1.00 [25]							.27 [7]	3.43 [87]	.31 [8]	.51 [13]	.12 [3]	1.38 [35]	12 OR 348																	
YA252TC14E145	2																									1.64 [42]	3.19 [81]	2.01 [51]	3.43 [87]	3.19 [81]	3.43 [87]									
YA252TC14E190	3																									1.97 [50]	1.64 [42]	1.97 [50]	1.64 [42]	1.97 [50]	1.64 [42]	1.97 [50]	1.64 [42]	1.97 [50]						

SEE SHEET 1 OF 20 FOR VIEWS & NOTES

REV: CREO\_08/10/21

TO ORDER BURNDY@PRODUCTS CALL		UNITED STATES: 1-800-346-4175 (LONDONDERRY, NH)		CANADA: 1-800-361-6975 (QUEBEC) 1-800-387-6487 (ALL OTHER PROVINCES)		FOR PRODUCT INFO: <a href="http://www.burndy.com">http://www.burndy.com</a>		HYLUG™			
ITEM NO:	N/A	CAT. NO:	YA-2TC-	(TABLE)		SCALE:	NTS	DRAWING NO			REV
DRAWN BY:	J. MICHAUD	11/8/93	CHECKER:	R. ROBICHEAU	1/10/94	PROJECT #:	--	SIZE	SE208777		P
DSN APPVL:	C. PALAGI	1/12/94	MFG APPVL:	N/A	--	DOCUMENT TYPE:	Sales	D	SHEET 8 OF 20		
QA APPVL:	A. LLOYD	1/24/94	MKT APPVL:	G. GORDON	1/20/94	REL LEVEL:	Released				
PROD FAM:	CM&R COMPRESSION										



REV	DATE	DESCRIPTION	ECO	BY	C'K'K.
P	2023-06-30 01:00:00 EDT	UPDATED AS PER MARKUP	230627031427	YR	RA



D	CATALOG NO.	FIG. NO.	CONDUCTOR		BOLT SIZE	DIMENSIONS								INSTALLATION TOOLING (# CRIMPS)																
			CODE (AWG)	NAVY		B	C	E	H	K	L	N	O.D.	T REF.	Y MIN.	DIE INDEX	COLOR CODE	MECHANICAL		HYDRAULIC				DIELESS (# CRIMPS)	WIRE STRIP LENGTH					
																		MD7-34R MD6	OUR840	Y34A	BCT500 Y500CT	Y750, Y35 Y39	Y46			Y45				
C	YA262TC14	1	2/0 AWG	125	1/4	1.50 [38]	.83 [21]	.62 [16]	-	.27 [7]	3.22 [82]	.31 [8]	.56 [14]	.12 [3]	.96 [24]	13	BLACK	W26VT W26RT (4)	W26VT W26RT (4)	A26R (2)	W26VT W26RT (4)	U26RT (2)	U26RT (2)	U26RT (2)	MECHANICAL: MY29-11 (1)  HYDRAULIC: Y644, Y644M Y644MBH, BAT644M Y1000 Y1000BH (1)	1-9/16				
	YA262TC1445	2				1.83 [46]	2.14 [54]	3.06 [78]	1.09 [28]																					
	YA262TC1490	3																												
	YA262TC14E2	1																												
	YA262TC14E245	2																												
	YA262TC14E290	3																												
	YA262TC38	1																												
	YA262TC3845	2						3/8	1.00 [25]	1.83 [46]	.40 [10]	3.50 [89]	.41 [10]	1.43 [36]																
	YA262TC3890	3																												
	YA262TC14E1	1																												
	YA262TC14E145	2			1/4	1.50 [38]	.83 [21]	1.00 [25]	1.83 [46]	.27 [7]	3.31 [84]	.31 [8]	.56 [14]	.12 [3]	1.34 [34]	13	BLACK	W26VT W26RT (4)	W26VT W26RT (4)	A26R (2)	W26VT W26RT (4)	U26RT (2)	U26RT (2)	U26RT (2)						
	YA262TC14E190	3	2/0 AWG	125																										

SEE SHEET 1 OF 20 FOR VIEWS & NOTES

REV: CREO\_08/10/21

TO ORDER BURNDY@PRODUCTS CALL		HYLUG™	
UNITED STATES: 1-800-346-4175 (LONDONDERRY, NH)		ITEM NO: N/A	
CANADA: 1-800-361-6975 (QUEBEC) 1-800-387-6487 (ALL OTHER PROVINCES)		CAT. NO: YA-2TC- (TABLE)	
FOR PRODUCT INFO: <a href="http://www.burndy.com">http://www.burndy.com</a>		DRAWN BY: J. MICHAUD 11/8/93	
		CHECKER: R. ROBICHEAU 1/10/94	
		DSN APPVL: C. PALAGI 1/12/94	
		MFG APPVL: N/A --	
		QA APPVL: A. LLOYD 1/24/94	
		MKT APPVL: G. GORDON 1/20/94	
		SCALE: NTS	
		PROD FAM: CM&R COMPRESSION	
		DRAWING NO	
		PROJECT #: --	
		SIZE	
		DOCUMENT TYPE: Sales	
		REL LEVEL: Released	
		SE208777	
		P	
		SHEET 9 OF 20	

REV	DATE	DESCRIPTION	ECO	BY	C'H'K.
P	2023-06-30 01:00:00 EDT	UPDATED AS PER MARKUP	230627031427	YR	RA

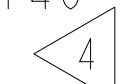
D	CATALOG NO.	FIG. NO.	CONDUCTOR		BOLT SIZE	DIMENSIONS									INSTALLATION TOOLING (# CRIMPS)										
			CODE (AWG)	NAVY 		B	C	E	H	K	L	N	O.D.	T REF.	Y MIN.	DIE INDEX	COLOR CODE	MECHANICAL		HYDRAULIC				DIELESS (# CRIMPS)	WIRE STRIP LENGTH
																		MD7-34R MD6	OUR840	BCT500 Y500CT	Y34A 	Y750, Y35 Y39	Y46 		
YA272TC14E2	1	3/0 AWG	150	1.50 [38]	.90 [23]	-	-	3.38 [86]	-	.62 [16]	.12 [3]	1.09 [28]	14	ORANGE	W27VT W27RT (4)	W27VT W27RT (4)	W27VT W27RT (4)	A27R (2)	U27RT (2)	U27RT (2)	U27RT (2)	MECHANICAL: MY29-11 (1)  HYDRAULIC: Y644, Y644M Y644MBH BAT644M Y1000 Y1000BH (1)	1-9/16		
YA272TC14E245	2	↑	↑	↑	↑	.75 [19]	1.86 [47]	.27 [7]	3.10 [79]	.31 [8]	↑	↑	↑	↑	↑	↑	↑	↑	↑	↑	↑		↑		
YA272TC14E290	3	↑	↑	↑	↑	2.19 [56]	2.19 [56]	1.82 [46]	1.82 [46]	↑	↑	↑	↑	↑	↑	↑	↑	↑	↑	↑	↑		↑		
YA272TC38	1	↓	↓	↓	↓	-	-	-	3.82 [97]	-	-	1.43 [36]	↓	↓	↓	↓	↓	↓	↓	↓	↓		↓		
YA272TC3845	2	↓	↓	↓	↓	1.00 [25]	1.86 [47]	.40 [10]	3.54 [90]	.41 [10]	↓	↓	↓	↓	↓	↓	↓	↓	↓	↓	↓		↓		
YA272TC3890	3	3/0 AWG	150	1.50 [38]	.90 [23]	2.19 [56]	2.19 [56]	2.25 [57]	2.25 [57]	.62 [16]	.12 [3]	1.43 [36]	14	ORANGE	W27VT W27RT (4)	W27VT W27RT (4)	W27VT W27RT (4)	A27R (2)	U27RT (2)	U27RT (2)	U27RT (2)		1-9/16		

C

C

B

B

A

A

SEE SHEET 1 OF 20 FOR VIEWS & NOTES

REV: CREO\_08/10/21

TO ORDER BURNDY@PRODUCTS CALL		HYLUG™	
UNITED STATES: 1-800-346-4175 (LONDONDERRY, NH)		ITEM NO: N/A	CAT. NO: YA-2TC- (TABLE)
CANADA: 1-800-361-6975 (QUEBEC) 1-800-387-6487 (ALL OTHER PROVINCES)		DRAWN BY: J. MICHAUD 11/8/93	CHECKER: R. ROBICHEAU 1/10/94
FOR PRODUCT INFO: <a href="http://www.burndy.com">http://www.burndy.com</a>		DSN APPVL: C. PALAGI 1/12/94	MFG APPVL: N/A --
		QA APPVL: A. LLOYD 1/24/94	MKT APPVL: G. GORDON 1/20/94
		PROD FAM: CM&R COMPRESSION	DRAWING NO: SE208777
		PROJECT #: --	SCALE: NTS
		DOCUMENT TYPE: Sales	REV: P
		REL LEVEL: Released	SHEET 10 OF 20



REV	DATE	DESCRIPTION	ECO	BY	C'K'.
P	2023-06-30 01:00:00 EDT	UPDATED AS PER MARKUP	230627031427	YR	RA

CATALOG NO.	FIG. NO.	CONDUCTOR		BOLT SIZE	DIMENSIONS										INSTALLATION TOOLING (# CRIMPS)											DIELESS (# CRIMPS)	WIRE STRIP LENGTH											
		CODE (AWG)	NAVY		B	C	E	H	K	L	N	O.D.	T REF.	Y MIN.	DIE INDEX	COLOR CODE	MECHANICAL		HYDRAULIC																			
																	MD7-34R MD6	OUR840	BCT500 Y500CT	Y34A 8	Y750, Y35 Y39	Y46 4	Y45 3	Y48B 9	Y60B													
YA282TC14E2	1	4/0 AWG	200	1/4	1.62 [41]	1.02 [26]	.75 [19]	-	.27 [7]	3.55 [90]	.31 [8]	.69 [18]	.14 [4]	1.09 [28]	15	PURPLE	W28VT W28RT (4)	W28VT W28RT (4)	W28VT W28RT (4)	A28R (2)	U28RT (2)	U28RT (2)	U28RT (2)	C28R (2)	L28RT (1)	MECHANICAL: MY29-11 (1)  HYDRAULIC: Y644, Y644M Y644MBH BAT644M Y1000 Y1000BH (1)	1-11/16											
YA282TC14E245	2				2.04 [52]	3.25 [83]		2.38 [61]		1.86 [47]							3.99 [101]	3.69 [94]	2.30 [58]	4.74 [120]	4.44 [113]	4.41 [10]	1.43 [36]	W28VT W28RT (4)	W28VT W28RT (4)			W28VT W28RT (4)	A28R (2)	U28RT (2)	U28RT (2)	U28RT (2)	C28R (2)	L28RT (1)				
YA282TC14E290	3				3/8	3/8	1.00 [25]	2.04 [52]	.40 [10]	3.69 [94]	2.30 [58]	4.74 [120]	4.44 [113]	.41 [10]	1.43 [36]	W28VT W28RT (4)	W28VT W28RT (4)	W28VT W28RT (4)	A28R (2)	U28RT (2)	U28RT (2)	U28RT (2)	C28R (2)	L28RT (1)														
YA282TC38	1	3/8	3/8	1.75 [44]			2.04 [52]	.40 [10]	3.69 [94]	2.30 [58]	4.74 [120]	4.44 [113]	.41 [10]	2.18 [55]	15	PURPLE	W28VT W28RT (4)	W28VT W28RT (4)	W28VT W28RT (4)	A28R (2)	U28RT (2)	U28RT (2)	U28RT (2)	C28R (2)	L28RT (1)													
YA282TC3845	2																4/0 AWG	200	3/8	1.62 [41]	1.02 [26]	.75 [19]	2.04 [52]	.27 [7]	3.25 [83]	.31 [8]	.69 [18]	.14 [4]	1.09 [28]	15	PURPLE	W28VT W28RT (4)	W28VT W28RT (4)	W28VT W28RT (4)	A28R (2)	U28RT (2)	U28RT (2)	U28RT (2)
YA282TC3890	3				2.38 [61]	1.86 [47]																										3.99 [101]	3.69 [94]	2.30 [58]	4.74 [120]	4.44 [113]	4.41 [10]	1.43 [36]
YA282NTC38	1	4/0 AWG	200	3/8	1.62 [41]	1.02 [26]	.75 [19]	2.04 [52]	.27 [7]	3.25 [83]	.31 [8]	.69 [18]	.14 [4]	1.09 [28]	15	PURPLE	W28VT W28RT (4)	W28VT W28RT (4)	W28VT W28RT (4)	A28R (2)	U28RT (2)	U28RT (2)	U28RT (2)	C28R (2)	L28RT (1)													
YA282NTC3845	2																3/8	3/8	1.00 [25]	2.04 [52]	.40 [10]	3.69 [94]	2.30 [58]	4.74 [120]	4.44 [113]	.41 [10]	1.43 [36]	W28VT W28RT (4)	W28VT W28RT (4)	W28VT W28RT (4)	A28R (2)	U28RT (2)	U28RT (2)	U28RT (2)	C28R (2)	L28RT (1)		
YA282NTC3890	3																																				2.38 [61]	1.86 [47]



SEE SHEET 1 OF 20 FOR VIEWS & NOTES

REV: CREO\_08/10/21

TO ORDER BURNDY@PRODUCTS CALL		UNITED STATES: 1-800-346-4175 (LONDONDERRY, NH)		CANADA: 1-800-361-6975 (QUEBEC) 1-800-387-6487 (ALL OTHER PROVINCES)		FOR PRODUCT INFO: <a href="http://www.burndy.com">http://www.burndy.com</a>		HYLUG™		ITEM NO: N/A		CAT. NO: YA-2TC- (TABLE)		DRAWN BY: J. MICHAUD 11/8/93		CHECKER: R. ROBICHEAU 1/10/94		DSN APPVL: C. PALAGI 1/12/94		MFG APPVL: N/A --		QA APPVL: A. LLOYD 1/24/94		MKT APPVL: G. GORDON 1/20/94		SCALE: NTS	
PROD FAM: CM&R COMPRESSION										DRAWING NO		REV		PROJECT #: --		SIZE		SE208777		P		REL LEVEL: Released		D		SHEET 11 OF 20	

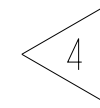
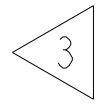

REV	DATE	DESCRIPTION	ECO	BY	C'K'K.
P	2023-06-30 01:00:00 EDT	UPDATED AS PER MARKUP	230627031427	YR	RA

CATALOG NO.	FIG. NO.	CONDUCTOR		BOLT SIZE	DIMENSIONS										INSTALLATION TOOLING (# CRIMPS)													WIRE STRIP LENGTH							
		SIZE	NAVY 		B	C	E	H	K	L	N	O.D.	T REF.	Y MIN.	DIE INDEX	TYPE	COLOR CODE	MECHANICAL				HYDRAULIC					DIELESS (# CRIMPS)								
																		MD7-34R	OUR840	MD6 MD7	MD6--R2	BCT500 Y500CT	Y34A 	Y34A Y34B Y34BH	Y750, Y35 Y39	Y46 			Y45 	Y48B	Y60B	Y60BHU			
YA292TC38	1	250 kcmil	250	3/8	1.10 [28]	1.00 [25]	-	.40 [10]	4.02 [102]	.41 [10]	.75 [19]	.16 [4]	1.43 [36]	16	--	YELLOW	W29VT W29RT (4)	X29RT (6)	--	--	W29VT W29RT (4) X29RT (6)	A29R (2)	--	U29RT (2)	U29RT (2)	U29RT (2)	C29R (2)	L29RT (1)	--	HYDRAULIC: Y644, Y644M Y644MBH BAT644M Y1000 Y1000BH (1)	1-11/16				
YA292TC3845	2						2.11 [54]		3.75 [95]								W29VT W29RT (4)	X29RT (6)	--	--	W29VT W29RT (4) X29RT (6)	A29R (2)	--	U29RT (2)	U29RT (2)	U29RT (2)	C29R (2)	L29RT (1)	--	MECHANICAL: MY29-3 (2) MY29-11(2)					
YA292TC3890	3						2.45 [62]		2.34 [59]								--	--	--	--	--	--	--	--	--	--	--	--	--	--		--	--	B29D(2) A29D(2) Y34PR	U29D-1(2) Y34PR
YA292TC58E16	1	250 kcmil	250	5/8	1.11 [28]	1.75 [44]	--	.69 [18]	5.27 [134]	.66 [17]	.75 [19]	.16 [4]	2.42 [62]	16	YELLOW	YELLOW DIE SET	--	X29RT (8)	W29VT (4)	W29RT (4) W29VT (4)	--	--	A29RT (2)	U29RT (2)	U29RT (2)	U29RT (2)	C29RT (2)	--	L29RT(1)	MECHANICAL: MY29-3 (2) MY29-11(2)					
YA292TC58E16	1			5/8	1.11 [28]	1.75 [44]	--	.69 [18]	5.27 [134]	.66 [17]						.75 [19]	.16 [4]	2.42 [62]	16	YELLOW	YELLOW DIE SET	--	X29RT (8)	W29VT (4)	W29RT (4) W29VT (4)	--	--	A29RT (2)	U29RT (2)	U29RT (2)	U29RT (2)	C29RT (2)	--	L29RT(1)	MECHANICAL: MY29-3 (2) MY29-11(2)



REV: CREO\_08/10/21

SEE SHEET 1 OF 20 FOR VIEWS & NOTES

TO ORDER BURNDY@PRODUCTS CALL		HYLUG™	
UNITED STATES: 1-800-346-4175 (LONDONDERRY, NH)		ITEM NO: N/A	
CANADA: 1-800-361-6975 (QUEBEC) 1-800-387-6487 (ALL OTHER PROVINCES)		CAT. NO: YA-2TC- (TABLE)	
FOR PRODUCT INFO: <a href="http://www.burndy.com">http://www.burndy.com</a>		DRAWN BY: J. MICHAUD 11/8/93	
		CHECKER: R. ROBICHEAU 1/10/94	
		DSN APPVL: C. PALAGI 1/12/94	
		MFG APPVL: N/A --	
		QA APPVL: A. LLOYD 1/24/94	
		MKT APPVL: G. GORDON 1/10/94	
		SCALE: NTS	
		PROD FAM: CM&R COMPRESSION	
		DRAWING NO	
		PROJECT #: --	
		SIZE	
		DOCUMENT TYPE: Sales	
		REL LEVEL: Released	
		SE208777	
		P	
		SHEET 12 OF 20	





REV	DATE	DESCRIPTION	ECO	BY	C'H'K.
P	2023-06-30 01:00:00 EDT	UPDATED AS PER MARKUP	230627031427	YR	RA

CATALOG NO.	FIG. NO.	CONDUCTOR		BOLT SIZE	DIMENSIONS									INSTALLATION TOOLING (# CRIMPS)														
		SIZE	NAVY		B	C	E	H	K	L	N	O.D.	T REF.	Y MIN.	DIE INDEX	COLOR CODE	MECHANICAL			HYDRAULIC						DIELESS (#CRIMPS)	WIRE STRIP LENGTH	
																	MD7-34R	BCT500 Y500CT	Y34A	Y750, Y35 Y39	Y46	Y45	Y48B	Y486RB	Y60B			
YA312TC14E2	1	350 kcmil	350	1/4	2.00 [51]	1.29 [33]	-	.27 [7]	4.05 [103]	.31 [8]	.88 [22]	.18 [5]	1.09 [28]	18 OR 324	RED	W31VT W31RT (4)	W31VT W31RT (4)	A29AR A31R (4)	U29ART U31RT (4)	U29ART U31RT (4)	U29ART U31RT (4)	C29AR C31R (1)	F29AR F31R (1)	L29ART L31RT (1)	HYDRAULIC: Y644, Y644M Y644MBH BAT644M Y1000 Y1000BH (1)	2-1/16		
YA312TC14E245	2						.75 [19]		2.54 [65]					3.68 [94]	18 OR 324	RED	W31VT W31RT (4)	W31VT W31RT (4)	A29AR A31R (4)	U29ART U31RT (4)	U29ART U31RT (4)	U29ART U31RT (4)	C29AR C31R (1)	F29AR F31R (1)			L29ART L31RT (1)	
YA312TC14E290	3						2.96 [75]		1.97 [50]					18 OR 324	RED	W31VT W31RT (4)	W31VT W31RT (4)	A29AR A31R (4)	U29ART U31RT (4)	U29ART U31RT (4)	U29ART U31RT (4)	C29AR C31R (1)	F29AR F31R (1)	L29ART L31RT (1)				
YA312TC38	1	350 kcmil	350	3/8	2.00 [51]	1.29 [33]	-	4.49 [114]	.40 [10]	.88 [22]	.18 [5]	1.43 [36]	18 OR 324	RED	W31VT W31RT (4)	W31VT W31RT (4)	A29AR A31R (4)	U29ART U31RT (4)	U29ART U31RT (4)	U29ART U31RT (4)	C29AR C31R (1)	F29AR F31R (1)	L29ART L31RT (1)	HYDRAULIC: Y644, Y644M Y644MBH BAT644M Y1000 Y1000BH (1)			2-1/16	
YA312TC3845	2						1.00 [25]	2.54 [65]					4.12 [105]	18 OR 324	RED	W31VT W31RT (4)	W31VT W31RT (4)	A29AR A31R (4)	U29ART U31RT (4)	U29ART U31RT (4)	U29ART U31RT (4)	C29AR C31R (1)	F29AR F31R (1)					L29ART L31RT (1)
YA312TC3890	3						2.96 [75]	2.41 [61]					18 OR 324	RED	W31VT W31RT (4)	W31VT W31RT (4)	A29AR A31R (4)	U29ART U31RT (4)	U29ART U31RT (4)	U29ART U31RT (4)	C29AR C31R (1)	F29AR F31R (1)	L29ART L31RT (1)					

SEE SHEET 1 OF 20 FOR VIEWS & NOTES



REV: CREO\_08/10/21

TO ORDER BURNDY@PRODUCTS CALL		HYLUG™	
UNITED STATES: 1-800-346-4175 (LONDONDERRY, NH)		ITEM NO: N/A	CAT. NO: YA-2TC- (TABLE)
CANADA: 1-800-361-6975 (QUEBEC) 1-800-387-6487 (ALL OTHER PROVINCES)		DRAWN BY: J. MICHAUD 11/8/93	CHECKER: R. ROBICHEAU 1/10/94
FOR PRODUCT INFO: <a href="http://www.burndy.com">http://www.burndy.com</a>		DSN APPVL: C. PALAGI 1/12/94	MFG APPVL: N/A --
		QA APPVL: A. LLOYD 1/24/94	MKT APPVL: G. GORDON 1/20/94
		SCALE: NTS	
		PROD FAM: CM&R COMPRESSION	DRAWING NO
		PROJECT #: --	SIZE
		DOCUMENT TYPE: Sales	SE208777
		REL LEVEL: Released	D
		SHEET 14 OF 20	

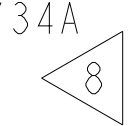

REV	DATE	DESCRIPTION	ECO	BY	CHK.
P	2023-06-30 01:00:00 EDT	UPDATED AS PER MARKUP	230627031427	YR	RA

D

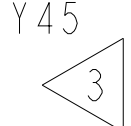
CATALOG NO.	FIG. NO.	CONDUCTOR		BOLT SIZE	DIMENSIONS										INSTALLATION TOOLING (# CRIMPS)										DIELESS (# CRIMPS)	WIRE STRIP LENGTH	
		SIZE	NAVY 		B	C	E	H	K	L	N	O.D.	T REF.	Y MIN.	MECHANICAL		HYDRAULIC										
															MD7-34R	BCT500 Y500CT	Y34A 	Y750, Y35 Y39	Y46 	Y45 	Y48B	Y486RB	Y60B				
YA322TC38	1																										
YA322TC3845	2	400 kcmil	400	3/8	2.12 [54]	1.40 [36]	1.00 [25]	2.72 [69]	.40 [10]	4.28 [109]	.41 [10]	.95 [24]	.19 [5]	1.43 [36]	19 OR 470	BLUE	W32RT (4)	W32RT (4)	A30AR A32R (4)	U30ART U32RT (4)	U30ART U32RT (4)	U30ART U32RT (4)	C30AR C32R (1)	F30AR (1)	L30ART L32RT (1)	HYDRAULIC: Y644, Y644M Y644MBH Y1000 Y1000BH (1)	2-3/16
YA322TC3890	3							3.16 [80]		2.46 [62]																	

C

B

A

SEE SHEET 1 OF 20 FOR VIEWS & NOTES

REV: CREO\_08/10/21

TO ORDER BURNDY@PRODUCTS CALL UNITED STATES: 1-800-346-4175 (LONDONDERRY, NH) CANADA: 1-800-361-6975 (QUEBEC) 1-800-387-6487 (ALL OTHER PROVINCES) FOR PRODUCT INFO: <a href="http://www.burndy.com">http://www.burndy.com</a>		HYLUG™ ITEM NO: N/A CAT. NO: YA-2TC- (TABLE) DRAWN BY: J.MICHAUD 11/8/93 CHECKER: R.ROBICHEAU 1/10/94 DSN APPVL: C.PALAGI 1/12/94 MFG APPVL: N/A -- QA APPVL: A.LLOYD 1/24/94 MKT APPVL: G.GORDON 1/20/94 PROD FAM: CM&R COMPRESSION PROJECT #: -- SIZE DOCUMENT TYPE: Sales REL LEVEL: Released		SCALE: NTS DRAWING NO: SE208777 SHEET 15 OF 20				P	
--	--	--	--	--	--	---	--	---	--

D

C

B

A

REV	DATE	DESCRIPTION	ECO	BY	C'H'K.
P	2023-06-30 01:00:00 EDT	UPDATED AS PER MARKUP	230627031427	YR	RA

D	CATALOG NO.	FIG. NO.	CONDUCTOR SIZE	BOLT SIZE	DIMENSIONS									INSTALLATION TOOLING (# CRIMPS)										DIELESS (# CRIMPS)	WIRE STRIP LENGTH	D		
					B	C	E	H	K	L	N	O.D.	T REF.	Y MIN.	DIE INDEX	COLOR CODE	MECHANICAL		HYDRAULIC									
																	MD7-34R	BCT500 Y500CT	Y34A	Y750, Y35 Y39	Y46	Y45	Y48B				Y486RB	Y60B
YA342TC14E2	1	500 kcmil	1/4	2.25 [57]	1.55 [39]	.75 [19]	-	.27 [7]	4.46 [113]	.31 [8]	1.06 [27]	.23 [6]	20 OR 299	BROWN	W34RT (4)	W34RT (4)	A34R (4)	U31ART (2) U34RT (4)	U31ART (2) U34RT (4)	U31ART (2) U34RT (4)	C31AR (1) C34R (2)	F31AR (1)	L34RT (2)	HYDRAULIC: Y644, Y644M Y644MBH BAT644M Y1000 Y1000BH (1)	2-5/16	C		
YA342TC14E245	2						3.43 [88]		4.07 [104]						2.09 [53]	U31ART (2) U34RT (4)	U31ART (2) U34RT (4)	U31ART (2) U34RT (4)	C31AR (1) C34R (2)	F31AR (1)	L34RT (2)							
YA342TC14E290	3						3.43 [88]		4.07 [104]						2.09 [53]	U31ART (2) U34RT (4)	U31ART (2) U34RT (4)	U31ART (2) U34RT (4)	C31AR (1) C34R (2)	F31AR (1)	L34RT (2)							
YA342TC38	1	500 kcmil	3/8	2.25 [57]	1.55 [39]	1.00 [25]	-	.40 [10]	4.90 [124]	.41 [10]	1.06 [27]	.23 [6]	20 OR 299	BROWN	W34RT (4)	W34RT (4)	A34R (4)	U31ART (2) U34RT (4)	U31ART (2) U34RT (4)	U31ART (2) U34RT (4)	C31AR (1) C34R (2)	F31AR (1)	L34RT (2)	HYDRAULIC: Y644, Y644M Y644MBH BAT644M Y1000 Y1000BH (1)	2-5/16	C		
YA342TC3845	2						3.43 [88]		4.51 [115]						2.53 [65]	U31ART (2) U34RT (4)	U31ART (2) U34RT (4)	U31ART (2) U34RT (4)	C31AR (1) C34R (2)	F31AR (1)	L34RT (2)							
YA342TC3890	3						3.43 [88]		4.51 [115]						2.53 [65]	U31ART (2) U34RT (4)	U31ART (2) U34RT (4)	U31ART (2) U34RT (4)	C31AR (1) C34R (2)	F31AR (1)	L34RT (2)							
YA342G66	1	500 kcmil	1/2	2.00 [51]	-	.56 [14]	6.33 [161]	.63 [16]	2.65 [67]	20 OR 299	BROWN	W34RT (4)	W34RT (4)	A34R (4)	U31ART (2) U34RT (4)	U31ART (2) U34RT (4)	U31ART (2) U34RT (4)	C31AR (1) C34R (2)	F31AR (1)	L34RT (2)	2-5/16	A						

SEE SHEET 1 OF 20 FOR VIEWS & NOTES

TO ORDER BURNDY@PRODUCTS CALL UNITED STATES: 1-800-346-4175 (LONDONDERRY, NH) CANADA: 1-800-361-6975 (QUEBEC) 1-800-387-6487 (ALL OTHER PROVINCES) FOR PRODUCT INFO: <a href="http://www.burndy.com">http://www.burndy.com</a>		HYLUG™ ITEM NO: N/A CAT. NO: YA-2TC- (TABLE) DRAWN BY: J.MICHAUD 11/8/93 CHECKER: R.ROBICHEAU 1/10/94 DSN APPVL: C.PALAGI 1/12/94 MFG APPVL: N/A -- QA APPVL: A.LLOYD 1/24/94 MKT APPVL: G.GORDON 1/20/94 PROD FAM: CM&R COMPRESSION PROJECT #: -- SIZE DOCUMENT TYPE: Sales REL LEVEL: Released		SCALE: NTS DRAWING NO: SE208777 SHEET 16 OF 20			
--	--	--	--	--	--	--	--

REV: CREO\_08/10/21



REV	DATE	DESCRIPTION	ECO	BY	C'K.
P	2023-06-30 01:00:00 EDT	UPDATED AS PER MARKUP	230627031427	YR	RA

CATALOG NO.	FIG. NO.	CONDUCTOR SIZE (CODE)	BOLT SIZE	DIMENSIONS										INSTALLATION TOOLING (# CRIMPS)									
				B	C	E	H	K	L	N	O.D.	T REF.	Y MIN.	DIE INDEX	COLOR CODE	HYDRAULIC					DIELESS (# CRIMPS)	WIRE STRIP LENGTH	
																Y750, Y35 Y39	Y46	Y45	Y48B	Y60B			
YA362TC38	1	600 kcmil	3/8				-		5.59 [142]													HYDRAULIC: Y644, Y644M Y644MBH, BAT644M Y1000 Y1000BH (1)	2-3/4
YA362TC3845	2			2.69 [68]	1.74 [44]	1.00 [25]	3.44 [87]	.40 [10]	5.17 [131]	.50 [13]	1.19 [30]	.26 [7]	1.53 [39]	22 OR 472	GREEN	U36RT U32ART (4)	U36RT U32ART (4)	U36RT U32ART (4)	C36R C32AR (2)	L36RT L32ART (2)			
YA362TC3890	3			4.04 [103]	2.81 [71]																		
YA382TC38	1	700 kcmil	3/8				-		5.76 [146]													HYDRAULIC: Y644M (1) BAT644M (1)	2-7/8
YA382TC3845	2			2.81 [71]	1.84 [47]	1.00 [25]	3.60 [91]	.40 [10]	5.29 [134]	.50 [13]	1.25 [32]	.27 [7]	1.53 [39]	400	PINK	U38RT (4)	U38RT (4)	U38RT (4)	-	L38RT (2)			
YA382TC3890	3			4.21 [107]	2.84 [72]																		

SEE SHEET 1 OF 20 FOR VIEWS & NOTES

REV: CREO\_08/10/21

TO ORDER BURNDY@PRODUCTS CALL		UNITED STATES: 1-800-346-4175 (LONDONDERRY, NH)		CANADA: 1-800-361-6975 (QUEBEC) 1-800-387-6487 (ALL OTHER PROVINCES)		FOR PRODUCT INFO: <a href="http://www.burndy.com">http://www.burndy.com</a>		HYLUG™		ITEM NO: N/A		CAT. NO: YA-2TC- (TABLE)		DRAWN BY: J.MICHAUD 11/8/93		CHECKER: R.ROBICHEAU 1/10/94		DSN APPVL: C.PALAGI 1/12/94		MFG APPVL: N/A --		QA APPVL: A.LLOYD 1/24/94		MKT APPVL: G.GORDON 1/20/94		SCALE: NTS			
																										DRAWING NO: SE208777		REV: P	
																										SHEET 17 OF 20			

REV	DATE	DESCRIPTION	ECO	BY	C'H'K.
P	2023-06-30 01:00:00 EDT	UPDATED AS PER MARKUP	230627031427	YR	RA

CATALOG NO.	FIG. NO.	CONDUCTOR SIZE	BOLT SIZE	DIMENSIONS										INSTALLATION TOOLING (# CRIMPS)												
				B	C	E	H	K	L	N	O.D.	T REF.	Y MIN.	DIE INDEX	COLOR CODE	HYDRAULIC						DIELESS (# CRIMPS)	WIRE STRIP LENGTH			
																Y750, Y35 Y39	Y46	Y45	Y48B	Y486RB	Y60B					
YA392NT38	1	750 kcmil	3/8	2.88 [73]	1.63 [41]	1.00 [25]	-	.40 [10]	5.87 [149]	.50 [13]	1.30 [33]	.27 [7]	1.53 [39]	24	BLACK	U39RT (4)	U39RT (4)	U39RT (4)	C39R (2)	F39R (2)	L39RT (2)	HYDRAULIC: Y644, Y644M Y644MBH, BAT644M Y1000 Y1000BH (1)	2-15/16			
YA392NT3845	2			1.63 [41]	3.71 [94]		5.38 [137]	24	BLACK	U39RT (4)	U39RT (4)	U39RT (4)	C39R (2)	F39R (2)	L39RT (2)											
YA392NT3890	3			1.63 [41]	4.32 [110]		2.87 [73]	24	BLACK	U39RT (4)	U39RT (4)	U39RT (4)	C39R (2)	F39R (2)	L39RT (2)											
YA392TC38	1		750 kcmil	3/8	2.88 [73]	1.91 [49]	1.00 [25]	-	.40 [10]	5.87 [149]	.50 [13]	1.30 [33]	.27 [7]	1.53 [39]	24	BLACK	U39RT (4)	U39RT (4)	U39RT (4)	C39R (2)	F39R (2)			L39RT (2)	HYDRAULIC: Y644, Y644M Y644MBH, BAT644M Y1000 Y1000BH (1)	2-15/16
YA392TC3845	2				1.91 [49]	3.71 [94]		5.38 [137]	24	BLACK	U39RT (4)	U39RT (4)	U39RT (4)	C39R (2)	F39R (2)	L39RT (2)										
YA392TC3890	3				1.91 [49]	4.32 [110]		2.87 [73]	24	BLACK	U39RT (4)	U39RT (4)	U39RT (4)	C39R (2)	F39R (2)	L39RT (2)										

SEE SHEET 1 OF 20 FOR VIEWS & NOTES

TO ORDER BURNDY@PRODUCTS CALL UNITED STATES: 1-800-346-4175 (LONDONDERRY, NH) CANADA: 1-800-361-6975 (QUEBEC) 1-800-387-6487 (ALL OTHER PROVINCES) FOR PRODUCT INFO: <a href="http://www.burndy.com">http://www.burndy.com</a>		HYLUG™ ITEM NO: N/A CAT. NO: YA- 2TC- (TABLE) DRAWN BY: J. MICHAUD 11/8/93 CHECKER: R. ROBICHEAU 1/10/94 DSN APPVL: C. PALAGI 1/12/94 MFG APPVL: N/A -- QA APPVL: A. LLOYD 1/24/94 MKT APPVL: G. GORDON 1/20/94 PROD FAM: CM&R COMPRESSION PROJECT #: -- SIZE DOCUMENT TYPE: Sales REL LEVEL: Released		 SCALE: NTS DRAWING NO: SE208777 SHEET 18 OF 20	
--	--	--	--	--	--

REV: CREO\_08/10/21

REV	DATE	DESCRIPTION	ECO	BY	C'H'K.
P	2023-06-30 01:00:00 EDT	UPDATED AS PER MARKUP	230627031427	YR	RA

D

D

CATALOG NO.	FIG. NO.	CONDUCTOR SIZE	BOLT SIZE	DIMENSIONS										INSTALLATION TOOLING (# CRIMPS)											
				B	C	E	H	K	L	N	O.D.	T REF.	Y MIN.	DIE INDEX	COLOR CODE	HYDRAULIC				DIELESS (# CRIMPS)	WIRE STRIP LENGTH				
																Y46	Y45	Y48B	Y60B						
YA402TC38	1						-		5.94 [151]																
YA402TC3845	2	800 kcmil	3/8	2.94 [75]	1.98 [50]	1.00 [25]	3.81 [97]	.40 [10]	5.49 [139]	.50 [13]	1.35 [34]	.30 [8]	1.53 [39]	25	ORANGE	P40RT (4)	S40RT (4)	C40R (2)	L40RT (2)	HYDRAULIC: Y644, Y644M Y644MBH BAT644M, Y1000 Y1000BH (1)	3-1/16				
YA402TC3890	3						4.46 [113]		2.91 [74]																

C

C

B

B

A

A

SEE SHEET 1 OF 20 FOR VIEWS & NOTES

REV: CREO\_08/10/21

TO ORDER BURNDY@PRODUCTS CALL		HULLUG™	
UNITED STATES: 1-800-346-4175 (LONDONDERRY, NH)		ITEM NO: N/A	
CANADA: 1-800-361-6975 (QUEBEC) 1-800-387-6487 (ALL OTHER PROVINCES)		CAT. NO: YA- 2TC- (TABLE)	
FOR PRODUCT INFO: <a href="http://www.burndy.com">http://www.burndy.com</a>		DRAWN BY: J. MICHAUD 11/8/93	
		CHECKER: R. ROBICHEAU 1/10/94	
		DSN APPVL: C. PALAGI 1/12/94	
		MFG APPVL: N/A --	
		QA APPVL: A. LLOYD 1/24/94	
		MKT APPVL: G. GORDON 1/20/94	
		SCALE: NTS	
		PROD. FAM: CM&R COMPRESSION	
		DRAWING NO	
		PROJECT #: --	
		SIZE	
		DOCUMENT TYPE: Sales	
		REL LEVEL: Released	
		SE208777	
		SHEET 19 OF 20	
		P	



REV	DATE	DESCRIPTION	ECO	BY	C'H'K.
P	2023-06-30 01:00:00 EDT	UPDATED AS PER MARKUP	230627031427	YR	RA

D

D

CATALOG NO.	FIG. NO.	CONDUCTOR SIZE	BOLT SIZE	DIMENSIONS										INSTALLATION TOOLING (# CRIMPS)												
				B	C	E	H	K	L	N	O.D.	T REF.	Y MIN.	DIE INDEX	COLOR CODE	HYDRAULIC					DIELESS (# CRIMPS)	WIRE STRIP LENGTH				
																Y46	Y45	Y48B	Y486RB	Y60B						
YA442TC38	1						-		6.14 [156]																	
YA442TC3845	2	1000 kcmil	3/8	3.00 [76]	2.19 [56]	1.00 [25]	4.06 [103]	.40 [10]	5.71 [145]	.50 [13]	1.50 [38]	.33 [8]	1.53 [39]	27	WHITE	S44RT (4)	P44RT (4)	C44R (2)	F44R (2)	L44RT (2)	HYDRAULIC: Y644, Y644M BAT644M, Y644MBH Y1000 Y1000BH (1)	3-1/16				
YA442TC3890	3						4.70 [119]		3.02 [77]																	

C

C

B

B

A

A

SEE SHEET 1 OF 20 FOR VIEWS & NOTES

REV: CREO\_08/10/21

TO ORDER BURNDY@PRODUCTS CALL		HYLUG™	
UNITED STATES: 1-800-346-4175 (LONDONDERRY, NH)		ITEM NO: N/A	
CANADA: 1-800-361-6975 (QUEBEC) 1-800-387-6487 (ALL OTHER PROVINCES)		CAT. NO: YA- 2TC- (TABLE)	
FOR PRODUCT INFO: <a href="http://www.burndy.com">http://www.burndy.com</a>		DRAWN BY: J. MICHAUD 11/8/93	
		CHECKER: R. ROBICHEAU 1/10/94	
		DSN APPVL: C. PALAGI 1/12/94	
		MFG APPVL: N/A --	
		QA APPVL: A. LLOYD 1/24/94	
		MKT APPVL: G. GORDON 1/20/94	
		SCALE: NTS	
		PROD. FAM: CM&R COMPRESSION	
		DRAWING NO	
		PROJECT #: --	
		SIZE	
		DOCUMENT TYPE: Sales	
		REL LEVEL: Released	
		SE208777	
		P	
		SHEET 20 OF 20	